

# User's Guide

Doc Rev. **08** (Nov 2019)

## EPD Extension Kit Gen2



### Preface

EPD\* Extension Kit Generation 2 (**EXT2**) is a new generation of extension board to the Texas Instruments' LaunchPad development platform to drive most of Pervasive Displays' EPDs.

It is designed to kick-start EPD development with your microcontrollers. There are onboard headers can be bridged to any of your development kit and product.

\* **EPD**: Electrophoretic display, Electronic paper display. E-Paper display

## Table of Contents

Preface .....	1
1. Introduction .....	3
1.1 Overview.....	3
1.2 EXT2 kit introduction.....	4
1.2.1 EXT2 kit contents.....	4
1.2.2 EPD Extension Board Gen2 (EXT2 board) .....	5
1.3 EPD Displays .....	6
1.3.1 FPL (E ink Imaging film):.....	6
1.3.2 COG (Chip on Glass):.....	6
1.3.3 Supported EPD Display Lineup for EXT2.....	7
1.4 TI LaunchPads.....	11
2. Getting Started .....	12
2.1 Assembling the EXT2 board with LaunchPad.....	12
2.1.1 Adjust the Jumpers of LaunchPad .....	12
2.1.2 Getting started with EXT2 kit.....	14
2.1.3 Stack the EXT2 board on LaunchPad.....	14
2.1.4 Connect the EPD to the EXT2 board.....	15
2.2 Programming firmware to LaunchPad.....	16
2.2.1 Download firmware file to LaunchPad by UniFlash .....	17
2.2.2 Install CCS and setup driver library .....	20
2.2.3 Load project and program firmware by CCS.....	21
2.2.4 Set driverlib path of MSP-EXP432P401R and EK-TM4C123GXL .....	23
2.3 Installing the PDI Apps.....	24
2.4 Working with PDI Apps.....	25
2.4.1 Global Update .....	26
2.4.2 Fast Update .....	28
2.4.3 Bitmap Converter.....	30
3. Hardware Instructions of EXT2 Kit.....	32
3.1 Introduction of EXT2 board.....	32
3.1.1 Headers and Connectors.....	33
3.2 How to bridge EXT2 with other development kit.....	34
3.3 Integration with front light guide .....	36
3.4 Integration with touch panel.....	37
3.5 Integration with Large size EPD(9.7"/12").....	38
4. Working with TI CCS Project Code .....	39
4.1 EPD_drivers Project.....	39
4.2 LaunchPad Name Project.....	41
5. Document revision history .....	43
6. Evaluation board/kit important notice .....	44

# 1. Introduction

## 1.1 Overview

Thank you for purchasing the EPD Extension Kit/Board Generation 2 (EXT Gen2, **EXT2**) for low-power electrophoretic paper display (**EPD**) solutions. This document provides an overview of the kit and is organized into four main sections.

1. The EXT2 introduction and supported EPD, material and drivers
2. Getting started with the EXT2 to drive EPD
3. Hardware instruction of EXT2 kit
4. Working with TI CCS project code

The 1<sup>st</sup> and 2<sup>nd</sup> sections are most of the user guide to instruct how to use the EXT2 kit and get the EPD working. The 3<sup>rd</sup> and 4<sup>th</sup> sections are more details of developing EPDs with EXT2 kit and provided project code.

The EXT2 is a new EPD Extension board to the Texas Instruments (**TI**)'s [LaunchPads](#) development platform supports driving most of Pervasive Displays Inc. (**PDI**)'s EPD panels lineup. It has 20 to 40 pins socket at the rear side to stack on TI's LaunchPad board. It also provides a 20 pins header to bridge with your project/product or other development kit.

The project of EXT2 is open source code provides driving waveform and command interface to update content on EPD panel for developer to start working with EPD application easily.





## 1.2 EXT2 kit introduction

### 1.2.1 EXT2 kit contents

Model name of EXT2 Kit: B3000MS034(24 pin connector supported)/B3000MS035(34 pin FFC supported)

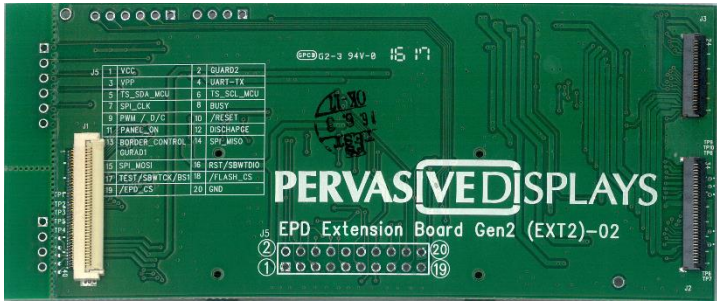
The EXT2 kit includes,

- B3000MS034: one EXT2 board, one 90 degrees 20 pins header and one bridging cable.
- B3000MS035: one EXT2 board, one 90 degrees 20 pins header, one bridging cable, one 34 pin FFC and one 9.7"/12" connection board.

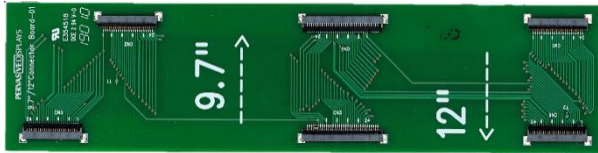
EPD Extension Board Gen2 (EXT2 board)	
	
90 degrees 20 pins header	Bridging cable
	
34 pins FFC(9.7"/12") for B3000MS035 only	Connection board(9.7"/12") for B3000MS035 only
	

## 1.2.2 EPD Extension Board Gen2 (EXT2 board)

Figure 1-1 EPD Extension Board Gen2 (front view)

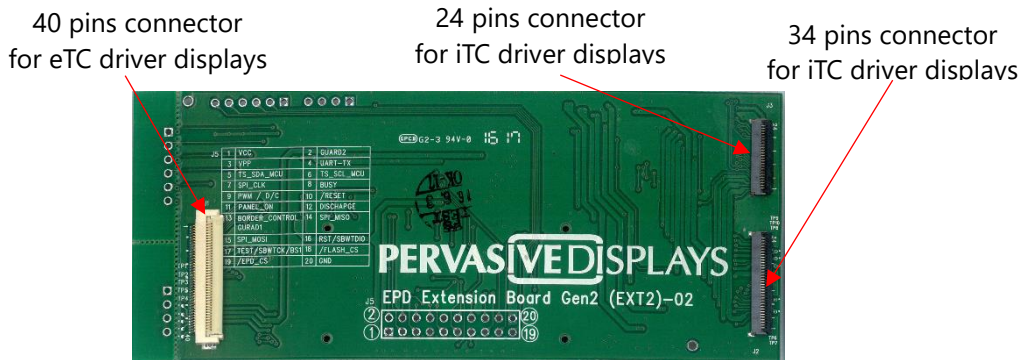

The EXT2 board supports driving most of the PDI’s EPD panels with the 40 and 24/34 pins FPC connector. The EXT2 board has embedded EPD driving circuit which are soldered at the backside.

💡 eTC and iTC will be explained later.

Figure 1-2 EPD Extension Board Gen2 (rear view)

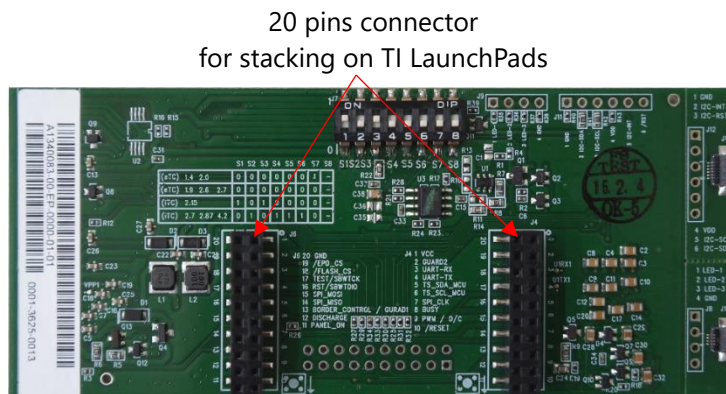

There are two 20 pins connectors at the backside of EXT2 board is able to stack on TI LaunchPads.

### 1.3 EPD Displays

Figure 1-3 Structure layer of EPD

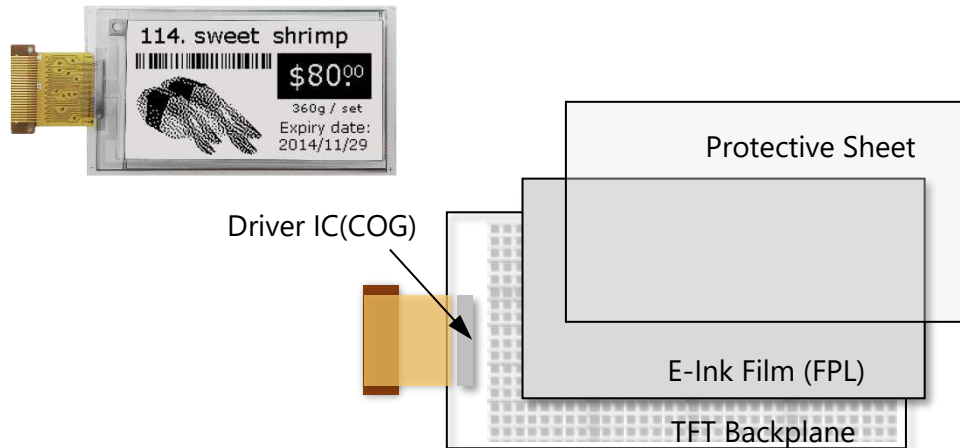

#### 1.3.1 FPL (E ink Imaging film):

Made by E-ink which is embedded in PDI's EPD panels. The EXT2 board supports driving the following films:

- **Aurora Ma:** also call **V230**. The display color is black and white. It supports operating at wide temperature from -20°C to +50°C. It has to load special driving waveform to get the display works. This film type display is suggested for lower temperature operation is the major criteria only.
- **Aurora Mb:** also call **V231**. The display color is black and white. Most of the cases, The Aurora Mb film type display provides the best performance, faster update speed and lower power consumption. It supports operating at room temperature from 0°C to +50°C.
- **Spectra:** also call **E4**. The display color is red, black and white, three colors. It supports operating at room temperature from +0°C to +40°C
- **Spectra Yellow:** The display color is yellow, black and white, three colors. It supports operating at room temperature from +10°C to +40°C
- **Aurora -25:** also call **V430**. The display color is black and white. It supports operating at a freezer temperature from -25°C to +10°C. This film type display is suggested for lower temperature operation is the major criteria only.

#### 1.3.2 COG (Chip on Glass):





also call Tcon (TC, Timing controller) or Driver IC which is mounted on TFT glass of EPD display.



- **eTC:** external Tcon, the driving waveform and flow are controlled by the host MCU (microcontroller). Developer needs to manage most of the driving stages, frame time and data flow by the MCU of host control board. The eTC includes PDI's G1, G1b and **G2** COG (where G1/G1b are EOL (end of life)). The pin number of FPC (flexible printed circuit) of eTC is 40 pins.

- **iTC**: internal Tcon, the driving waveform and settings are managed by Lookup Table (LUT). The LUT is serial hex array includes the waveform parameters. User will need to send defined LUT and image data to COG. The COG will extract the waveform settings from the LUT to update display by following image data. The pin number of FPC of iTC is 24 or 34.

### 1.3.3 Supported EPD Display Lineup for EXT2

Table 1-1 Supported EPDs for EXT2

Size	Picture	Resolution	Pixel Density (dpi)	Model No.	FPL	COG
1.44"		128 x 96	111	E2144CS021	Aurora Mb	eTC
1.54"		152 x 152	140	E2154CS091	Aurora Mb	iTC
				E2154FS091	Spectra	
				E2154GS093	Spectra Yellow	
1.90"		144 x 128	101.6	E2190CS021	Aurora Mb	eTC
2.00"		128 x 96	111	E2200BS021	Aurora Ma	eTC
				E2200CS021	Aurora Mb	
2.13"		212 x 104	111	E2213FS091	Spectra	iTC
				E2213GS091	Spectra Yellow	
				E2213HS091	Aurora -25	
				E2213CS091	Aurora Mb	

2.6"		232 x 128	101.6	E2260CS021	Aurora Mb	eTC
2.66"		296 x 152	125	E2266FS092	Spectra	iTC
				E2266GS094	Spectra Yellow	
				E2266HS092	Aurora -25	
				E2266CS091	Aurora Mb	
2.71"		264 x 176	117	E2271BS021	Aurora Ma	eTC
				E2271CS021	Aurora Mb	
		264 x 176	117	E2271CS091	Aurora Mb	iTC
				E2271FS091	Spectra	
2.87"		296 x 128	112	E2287CS091	Aurora Mb	iTC
				E2287FS091	Spectra	
3.7"		240 x 416	130	E2370FS081	Spectra	iTC



4.2"		400 x 300	120	E2417FS051 /E2417FS052	Spectra	iTC
				E2417CS053	Aurora Mb	
				E2417GS054	Spectra Yellow	
4.37"		480 x 176	117	E2437FS083	Spectra	iTC
				E2437GS083	Spectra Yellow	
5.8"		256 x 720	134	E2581CS081	Aurora Mb	iTC
				E2581JS081	Spectra	
7.4"		480 x 800	126	E2741CS084	Aurora Mb	iTC
				E2741FS081	Spectra	
				E2741GS081	Spectra Yellow	
9.7"		672 x 960	121	E2969CS081	Aurora Mb	iTC
				E2969JS081	Spectra	

12.2"		960 x 768	103	E2B98FS081	Spectra	iTC
				E2B98GS082	Spectra Yellow	
				E2B98CS082	Aurora Mb	

💡 There are more sizes with iTC COG will be added in the table above in the future, please keep watching on our release of sample project code, PDi website or contact PDI for more information.

## 1.4 TI LaunchPads

The Texas Instruments (TI)'s [LaunchPad](#) is **excluded** in the EXT2 kit, so user and developer has to purchase the LaunchPad on TI official website or other online webshop.

The supported LaunchPads for EXT2 kit that are provided CCS ([Code Composer Studio™](#)) project source code are

- MSP: [MSP-EXP432P401R](#), [MSP-EXP430F5529LP](#)
- Connected: [EK-TM4C123GXL](#) (Recommended for iTC EPD)



There are more LaunchPads will be supported in the CCS projects. Please kindly keep watching on our updated project code in PDI website of EXT2 kit.



If you are first time with this EXT2 kit and will order TI LaunchPad to work with, we would highly suggest choosing **EK-TM4C123GXL** for more functions that we will offer.

## 2. Getting Started

This section provides instructions to set up the EXT2 kit with TI LaunchPads and use the **PDI Apps** to update image on EPD display.

There are four steps to prepare the kit:

- (1) **Assembling the EXT2 board with LaunchPad**
- (2) **Programming firmware to LaunchPad**
- (3) **Installing the PDI Apps**
- (4) **Working with PDI Apps**

### 2.1 Assembling the EXT2 board with LaunchPad

We will need to set the jumpers of LaunchPad in order to get the LaunchPad programmable.

#### 2.1.1 Adjust the Jumpers of LaunchPad

- **MSP-EXP430F5529LP LaunchPad**

- eZ-FET Jumper:

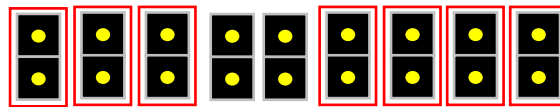
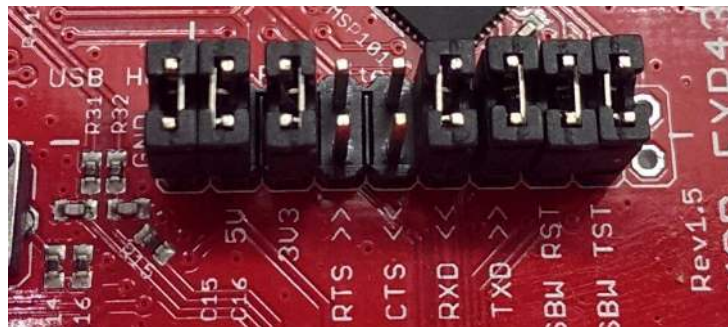

- JP8 Jumper:

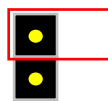
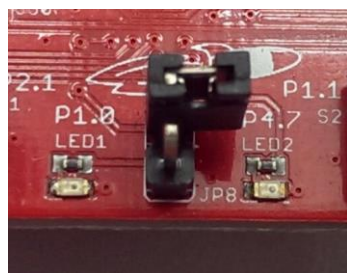

- **MSP-EXP432P401R LaunchPad(Black PCB version)**

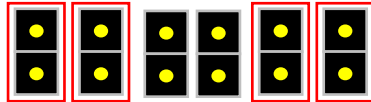
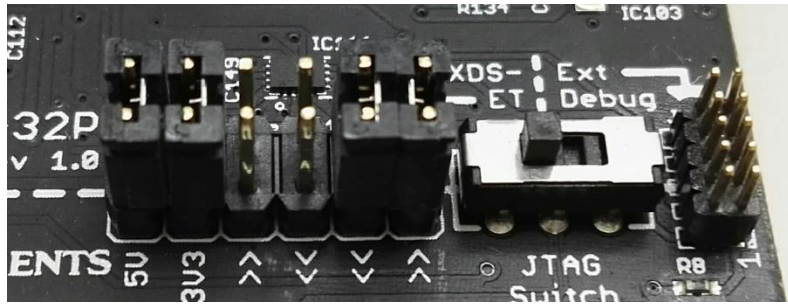

- **EK-TM4C123GXL LaunchPad**
  - PWR Selecting switch to DEBUG side



### 2.1.2 Getting started with EXT2 kit

Please check with the backside of EXT2 board. You will find a table for adjusting the J7 of 8 positions of DIP switch.

**Table 2-1 Configuration of the DIP switch**

								
	S1	S2	S3	S4	S5	S6	S7	S8
(eTC) 1.44 2.0	0	0	0	0	0	0	1	-
(eTC) 1.9 2.6 2.71	0	0	0	0	0	0	0	-
(iTC) 1.54 2.13 2.66 2.71 2.87 3.7 4.2 4.37 7.4 5.8 9.7 12.2	0	1	0	1	0	1	0	-

When connecting with any EPD, please always check with this table and switch each shift register from S1 to S8 accordingly. The 0 means Off and set the shift register at the bottom. The 1 means On and set the shift register to the top. The dash means (don't care) either 0 or 1 is fine.

### 2.1.3 Stack the EXT2 board on LaunchPad

After adjusting the jumpers of LaunchPad and EXT2, please stack the EXT2 board on LaunchPad. There are two 20 pins socket at the rear of EXT2 board allows user to stack on LaunchPad board. Please make sure the assembly direction of EXT2 board to align with LaunchPad headers. Most of the cases, when facing to the LaunchPad, the USB port is at the top side.

**Figure 2-1 Stack EXT2 on LaunchPad**

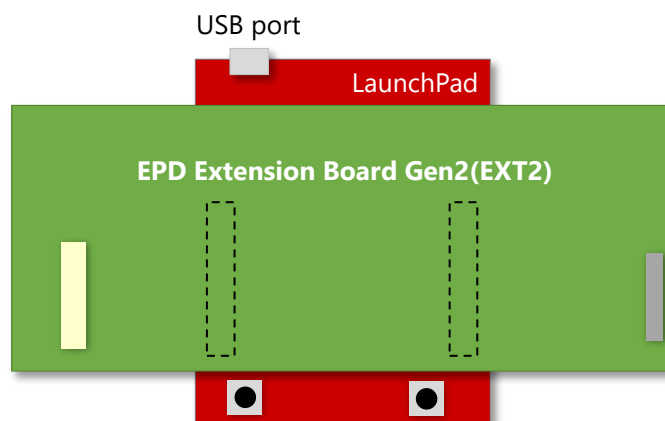

### 2.1.4 Connect the EPD to the EXT2 board

- Connecting with 40-pins eTC connector (J1)

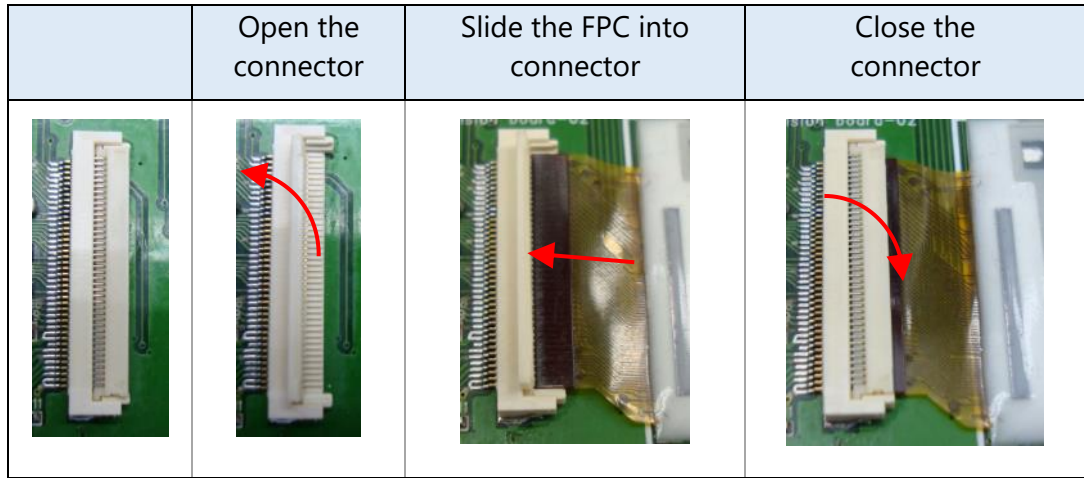

Note the pin1 is at the top side.

- Connecting with 24/34-pins iTC connector (J3/J2)

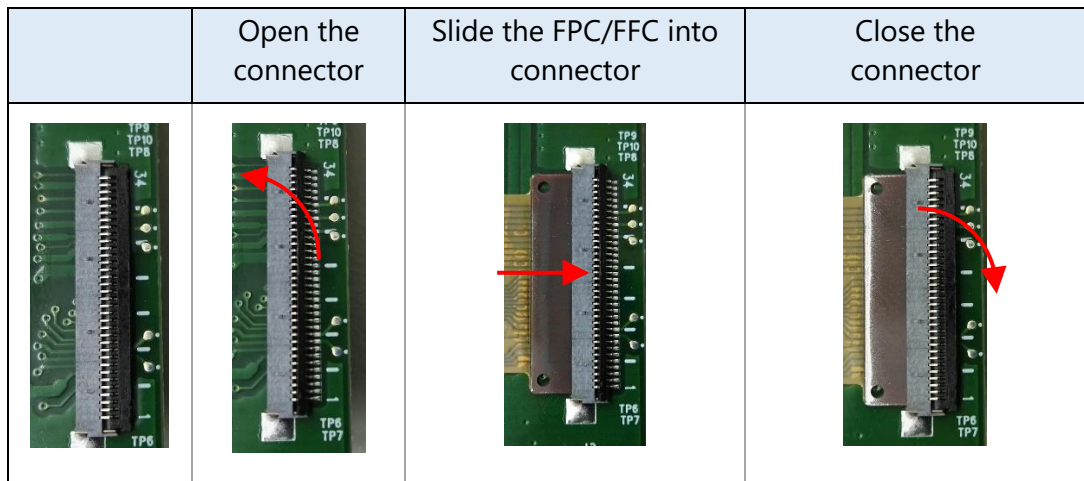

Note the pin1 is at the bottom side.

- 9.7"/12" Connection board with a 34-pins FFC connecting to iTC connector J2(B3000MS035 only)

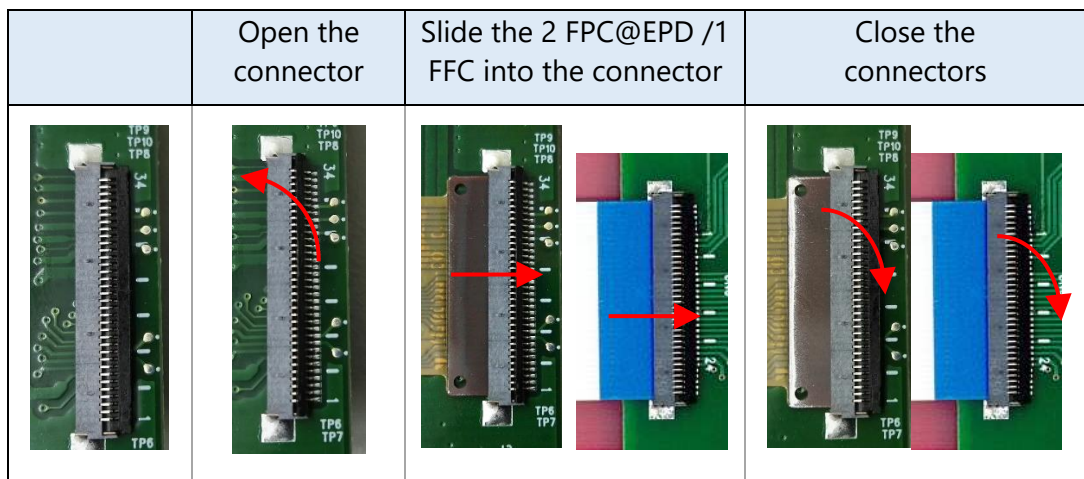



## 2.2 Programming firmware to LaunchPad

Before you proceed to get started with EXT2 kit, you have to download the EXT2 project source code from PDI website in advance.

Download link: [EPD Extension Board Gen2 \(EXT2\)](#)

You will be asked to fill out your basic contact information and then you will receive an email to show the download link.

Please download and extract it (.RAR file format usually).

	 <p>If you don't have CCS or you don't plan installing CCS to develop EPD product and will just want to demo or test EPDs, please refer to section 2.2.1 Download firmware file to LaunchPad by UniFlash which is the next section.</p>
	 <p>If you have CCS installed and you will develop EPD product based on our provided project source code, please go to section 2.2.2 "Install CCS and setup driver library" to section 2.2.4 to program the project code in CCS IDE.</p>



### 2.2.1 Download firmware file to LaunchPad by UniFlash

[CCS UniFlash](#) is a free of charge and standalone tool used to program on-chip flash memory on TI MCUs and on-board flash memory. Uniflash has a GUI, command line, and scripting interface.

- Please download CCS UniFlash tool from [this link](#) and install it in your computer. It's better you can read the [Quick Start Guide of UniFlash](#).
- During installation, you will be asked to select Components.

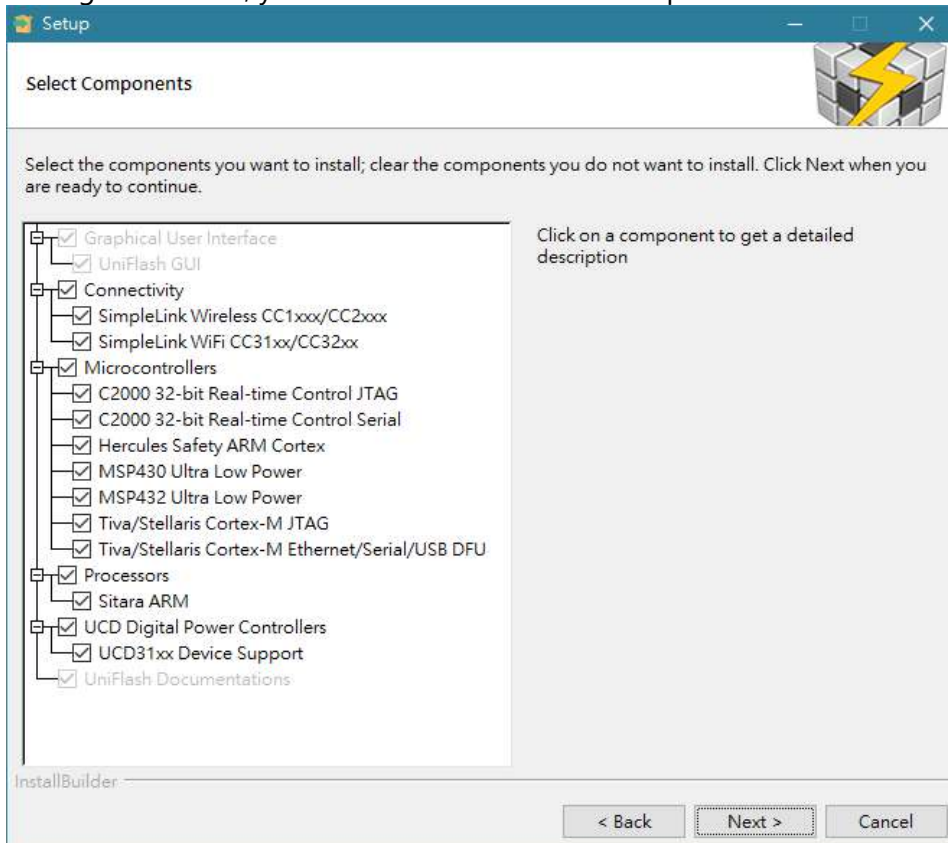

Depends on what LaunchPad will you connect with, you will just need to select the Microcontrollers. For example: MSP-EXP430F5529LP to select "MSP430 Ultra Low Power", MSP-EXP432P401R to select "MSP432 Ultra Low Power" and EK-TM4C123GXL to select both of "Tiva/Stellaris Cortex-M".

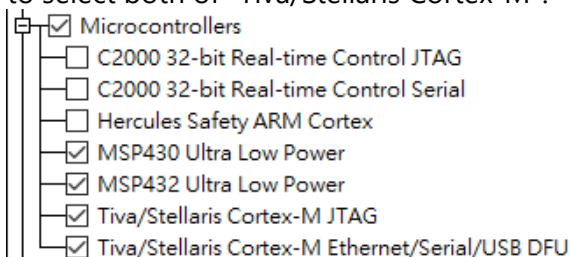

- In next step, deselect the Debug Probes

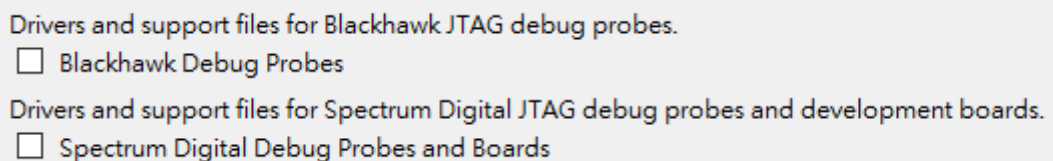

Click Next until the CCS UniFlash is installed in your computer.



- Launch the CCS UniFlash tool, you will see the clean user interface below

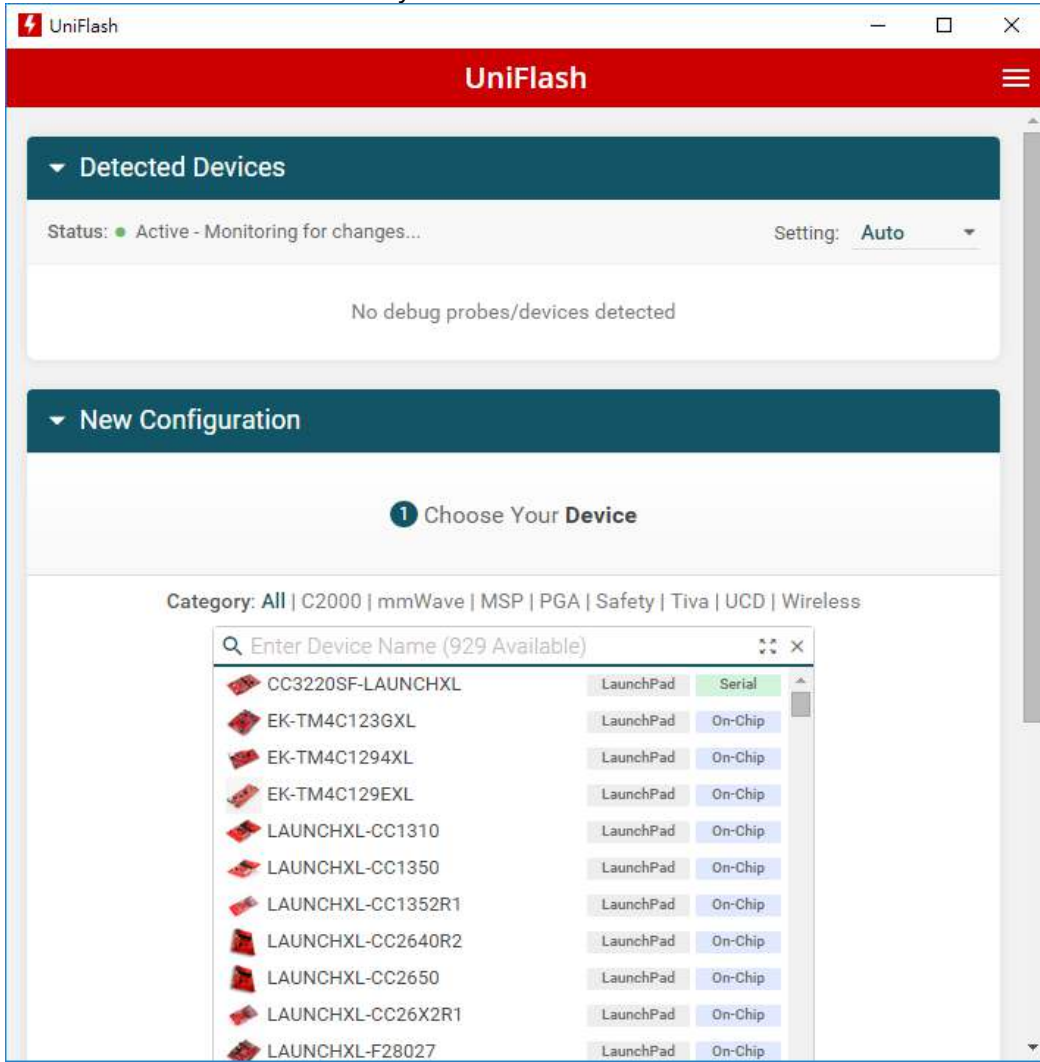

We have setup Configurations for our supported LaunchPads for you to use directly. There is an "Auto" detection on Uniflash and it will recognize the connected device. Or you can click "Select" on Create Session From Existing Target Configuration File to select the configuration file at the extracted folder from "EPD Extension Board Gen2 (EXT2)" project code under [Output] / [UniFlash] folder. Please select the LaunchPad name accordingly (EPD\_Extension\_Board\_LaunchPadName.ccxml). Hereafter, will use MSP-EXP432P401R as example:

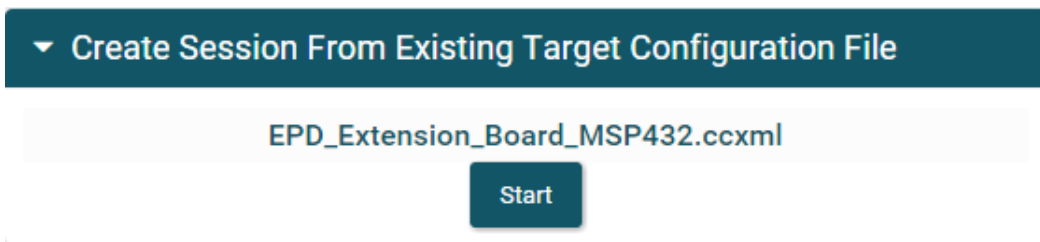
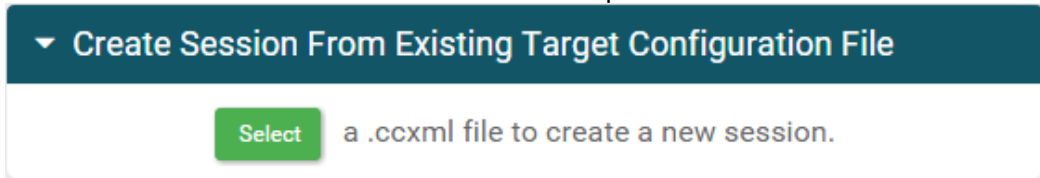

- Click "Start" button to complete this step. You will see the configuration be loaded automatically in the CCS UniFlash tool.

- In general, you don't need to change all the setting.

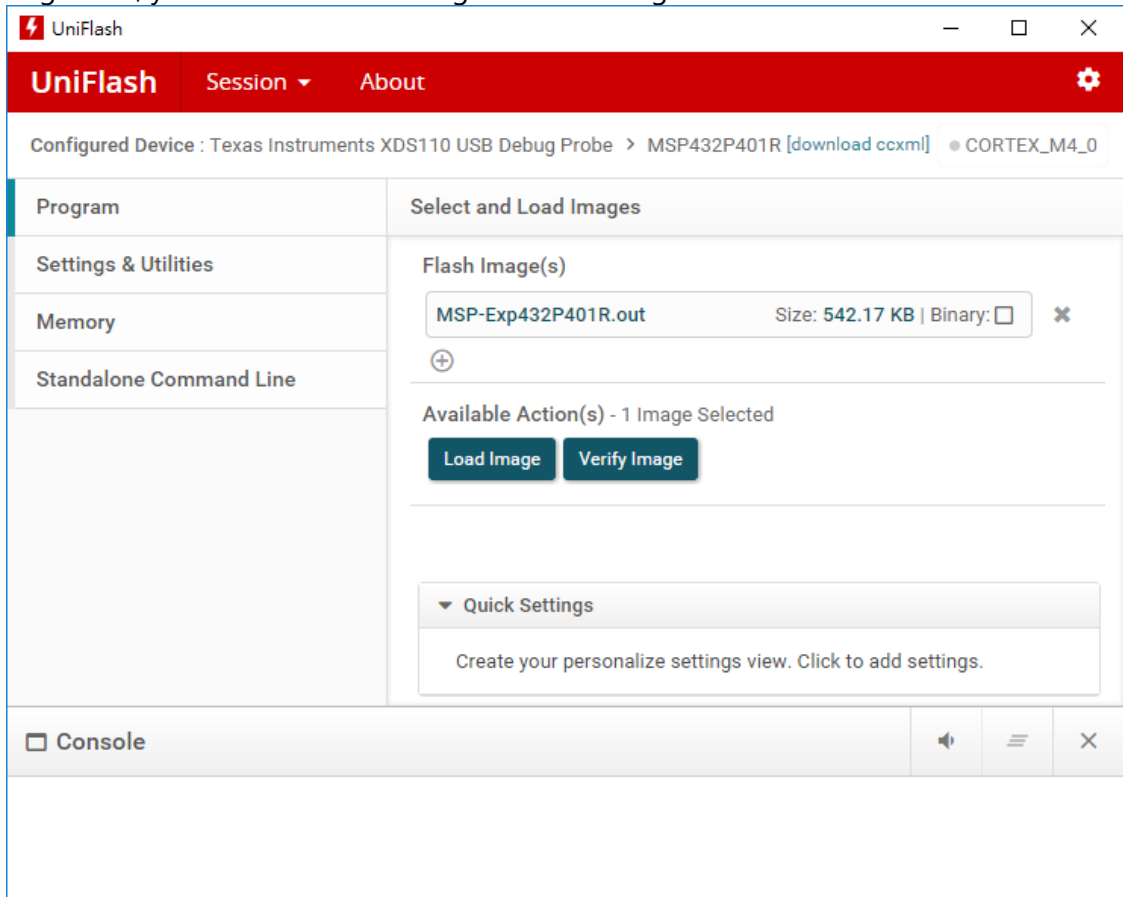

Click the **Load Image** button to start programming the firmware into LaunchPad. If there is no error appears in the Console window and it reports "[SUCCESS] Program Load completed successfully." which means the programming work is loaded successfully.

- You can now close the CCS UniFlash tool and go to Section 2.3 Installing the PDI Apps.

## 2.2.2 Install CCS and setup driver library

The sections from this to 2.2.4 are for user will develop EPD and debug with our provided project source code in CCS IDE.

Before proceeding to program project code into LaunchPad by CCS, you will need to download the following software.

- The latest version of TI [Code Composer Studio™](#) (CCS) and install in your computer.
  - 💡 During the installation, please select **MSP430 compiler** and **ARM compiler** at least.
- After installed the CCS, you have to install the driver library to work with your LaunchPad that will develop with. Download and install the latest driver library at:
  - MSP-EXP430F5529LP LaunchPad: [MSPWare](#)
  - EK-TM4C123GXL LaunchPad: [TivaWare™ software for C Series Software \(Complete\)](#)
  - MSP-EXP432P401R LaunchPad: [MSPWare](#)
- Try to connect with your LaunchPad on USB port and see if your Device Manager can detect the COM ports (COM number may different) as follows. If not, please install the USB driver of the LaunchPad accordingly.
  - 💡 There is an alternative way to install drivers. You can install CCS UniFlash that is introduced in Section 2.2.1.
    - **MSP-EXP430F5529LP** LaunchPad:
      - 🖨️ MSP Application UART1 (COM13)
      - 🖨️ MSP Debug Interface (COM12)
 the latest MSP430Drivers Windows-installer at [this webpage](#).
      - 💡 If you cannot get the MSP-EXP430F5529LP COM port detected by Device Manager, please refer to the [user's guide of MSP430F5529](#) at section 2.2.3 to 2.2.6.
    - **EK-TM4C123GXL** LaunchPad:
      - 🖨️ Stellaris Virtual Serial Port (COM8)
 the latest Stellaris® ICDI Drivers for Windows at [this webpage](#) or [this webpage](#).
      - 💡 If you cannot get the EK-TM4C123GXL COM port detected by Device Manager, please refer to the [user's guide of TM4C123G](#) at section 2.3 to 3.2.
    - **MSP-EXP432P401R** LaunchPad:
      - 🖨️ XDS110 Class Application/User UART (COM3)
      - 🖨️ XDS110 Class Auxiliary Data Port (COM4)
 the latest XDS Emulation Software Package for Windows at [this webpage](#).
      - 💡 If you cannot get the MSP-EXP432P401R COM port detected by Device Manager, please refer to the [user's guide of MSP432P401R](#) at section 2.3.1 to 2.3.3.

### 2.2.3 Load project and program firmware by CCS

Open CCS and switch the workspace to the root folder of EXT2 project code. After loading the project code in CCS IDE, you will find the Project Explorer like the screen capture below. The newer project code will support more LaunchPads in the list.

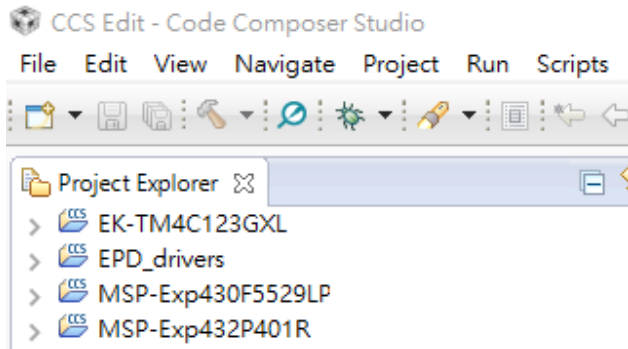

- Click on the Project name of your current LaunchPad. The project name will be added [Active – (configuration)] at the end. For example:

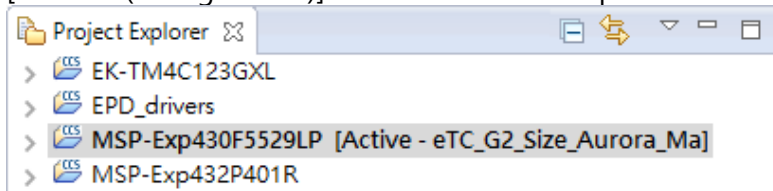

- Right click on the project name and find [Build Configurations] / [Set Active] from the pop-up submenu. You will see the configuration list. The format is:

**DriverType\_(DriverID if eTC)\_Size\_FPL\_Description**

Where:

- DriverType = iTC, eTC
- DriverID = G1, G2
- Size = 144, 190, 200, 215, 260, 271, 287, 420 and more, or "Size" for same group
- FPL = Aurora\_Ma, Aurora\_Mb, Spectra
- Description = detail description of the configuration



There is a configuration "**PDI APPS**" at the top for working with the PDI Apps utility that supports all models.

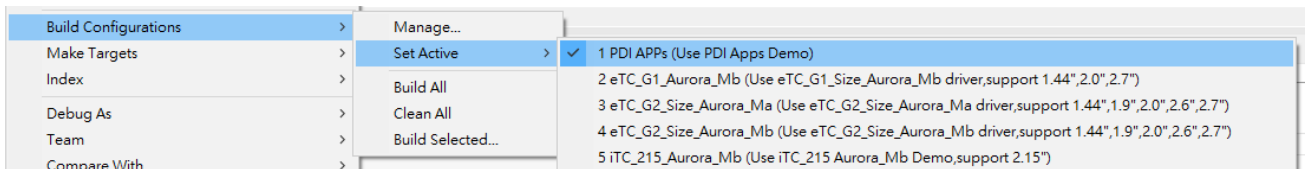

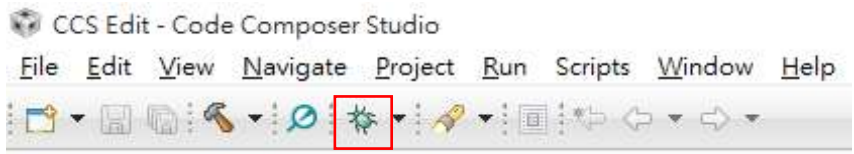

If you don't know **how to recognize the size, FPL and driver type**, please refer to [this webpage](#) and check the rear label of display.

- Please make sure you have selected the correct configuration before programming to LaunchPad and the project name follows correct [Active – configuration] you have selected.
- Click on the [Debug] button of tool bar or right click on the project to select [Debug As] / [1 Code Composer Debug Session].



- A progress information window will pop up and start to download firmware code to the microcontroller of LaunchPad board. Once the download process is done successfully with errors, the LaunchPad board is now built and tested of the firmware code. You can start debugging the code.

Click the  Terminate button go back to CCS Edit.

 If you didn't select the configuration of "PDI APPs", you will see the display be updated between two images alternately. For more details of selecting the configuration to Single mode, please refer to the conf\_EPD.h file in section 4.2 at page 42.

 If your CCS is free license, the code size is 16KB only for MSP430 family. Due to this limitation, if you are using MSP430F5529 LaunchPad, you will get the out of memory error when compiling with "PDi Apps" configuration. You may need to

- (1) order license of CCS,
- (2) program the .out file by UniFlash,
- (3) select single drive configuration without working with PDi Apps below.

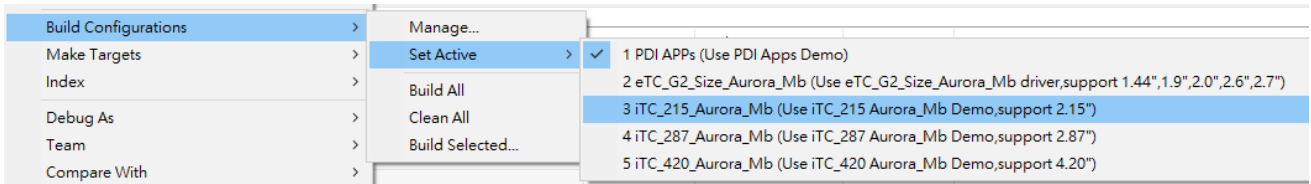

## 2.2.4 Set driverlib path of MSP-EXP432P401R and EK-TM4C123GXL

If you got errors with MSP-EXP432P401R or EK-TM4C123GXL when compiling, it should be caused by the wrong MSPWare/TivaWare library path settings.

- **Build Variables**

Please right click on project and select [Properties] and find [Build] from the tree view. Select [Variables] tab to set the variables name of library path in your computer.

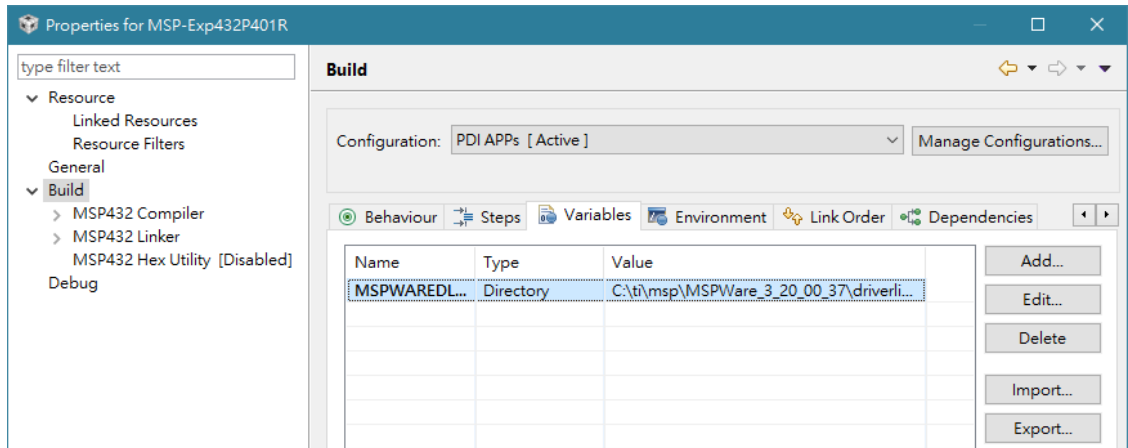

Please make sure the value would be:

LaunchPad	Variable name	Type	Value (same as value in Linked Resources)
MSP-EXP432P401R	MSPWAREDLIB_ROOT	Directory	C:\ti\msp\MSPWare_#_##_##_##_\driverlib\driverlib\MSP432P4xx
EK-TM4C123GXL	TIVAWAREDLIB_ROOT	String	C:\ti\TivaWare_C_Series-#.#.#.###

Where the # are the version number you have installed in your computer at section 2.2.2. Please click the [Edit] button to ensure you can find the directory and have set the correct directory.

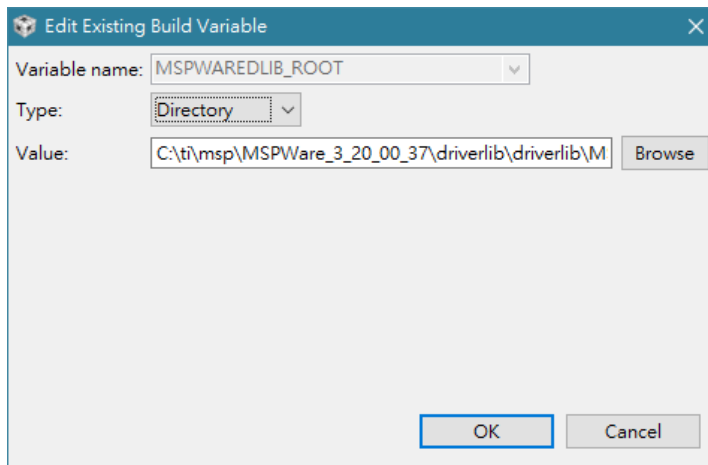

 As before 2017/Feb/22, the version of TivaWare\_C\_Series is v2.1.4.178, MSP430 is v3.50.00.02 and MSP432 is v3.50.00.04 for your reference. The project code of EXT2 will be updated to compile with the libraries.

### 2.3 Installing the PDI Apps

- Download the **PDI Apps** from [EPD Extension Board Gen2 \(EXT2\)](#) webpage. You will be asked to fill out your basic contact information and then you will receive an email to show the download link.

Please note the installer is for Microsoft Windows OS only and Windows 7 above.

The installer name is "PDI\_Apps\_v#.##\_Setup.exe" where the # is number for tool version. Double clicks the installer to start the installation.



PDI\_Apps\_V1.20  
Setup.exe

- Follow the instructions on the screen to install the utility. After installed, you will find there is a shortcut "PDI\_Apps" placed on your desktop.



PDI\_Apps

- Per the LaunchPad you will connect with EXT2, there is USB driver needs to be installed. Please refer to Section 2.2.2 to make sure you get the COM ports can be detected in Device Manager in advance.



## 2.4 Working with PDI Apps

Double click on the PDI\_Apps icon on your desktop. The initial screen will similar to the picture below. Support size: eTC(1.44"/1.9"/2.0"/2.6") iTC(1.54"/2.13"/2.66"/2.71"/2.87"/4.2")

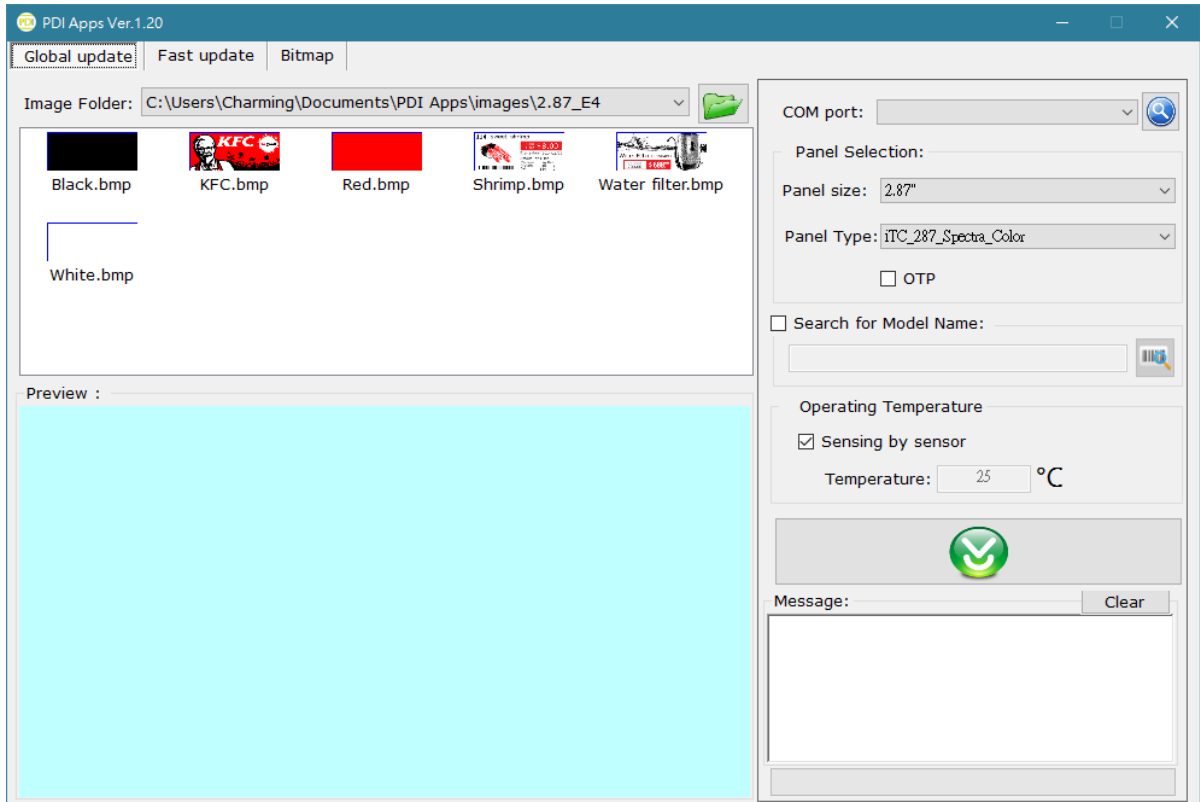

There are three main functions built in this Apps: Global Update, Fast Update and Bitmap converter.

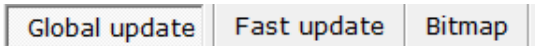

### 2.4.1 Global Update

This function will send our standard driving waveform to EPD and perform a complete global (full) update cycle including power on and power off the EPD. Global Update provides the best optical performance and will perform three or four update stages.

- **COM Port:**

If you've programmed the firmware well, the COM port will be auto detected and the message area will show COM port is connected to your EXT2 board with firmware version information. If there is no COM port detected, please click the  button to detect again and select the correct COM port from the dropdown list.

- **Panel Selection:**

Here will list the supported sizes and types of EPD by the programmed firmware. Please select the size first and the second dropdown will list the supported DriverType\_Size\_FPL accordingly. If you don't know how to recognize the size, FPL and driver type, please refer to [this webpage](#) and check the rear label of display.

The  **OTP** means **One-Time Programmable (OTP)** function which is the driving waveform preprogrammed in driver IC of EPD in factory to provide the best tuned performance.

When you are connecting with iTC EPD with EXT2, this OTP option should be always selected.

 The OTP option can be selected when the Panel Type is iTC related only.

 For further support of custom **LUT (Lookup Table)** not by OTP, please contact us for more information.

- **Search for Model Name:**

If it's still hard for you to select the correct EPD size and type at the previous step, you can use barcode scanner to scan the barcode or type the serial number on the rear label of the display, then click the  button to help you select the correct EPD type.

- **Operating Temperature:**

The EPD needs temperature information to compensate the total update time. If you've checked with the  **Sensing by sensor**, the following update will get the temperature

value from the onboard thermal sensor. If you uncheck with the auto sensing, you can specify the temperature in the textbox to evaluate the update time accordingly. This option is used for real ambient temperature. If you define the custom temperature at different ambient temperature environment, you may get abnormal phenomenon on the display.

- **Image Folder:**

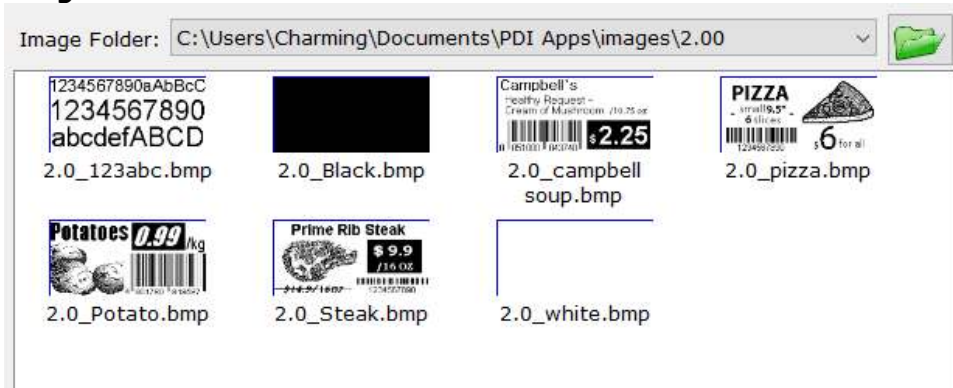

After installed the PDI Apps, we provide some demo patterns in your user folder at [C:\Users\...\Documents\PDI Apps\images]. Click on  button to select the size folder of EPD and then the thumbnails will be listed in the area below. You can also select any dimension of picture and this tool will convert it to panel size (ex.2”) as bitmap file format for update.

Double click on the image you like to update on EPD, the image will show on the preview area.

- **Download image to EPD:**





Click on this button to update the selected image to the EPD. You will get the information in the Message area including temperature and total update time.

### 2.4.2 Fast Update

This page provides full image to run fast update. It's a kind of partial update (local update) that just the pixel color is different between two images will be updated (black to white or white to black). It's sent the full images continuously and compare with the previous image and new image pixel by pixel.

- Image List:**



- Click on the  button to select the image for update. You can hold down the <Ctrl> key to select multiple images and then these images will be generated in Image List together. Once selected, a new object will be created for next image. Click on  to delete the image. Right click and hold on the image to drag & drop to your preferred place to change the order.
- Selected with the  GU if this image will run global update. This is used in the scene when there is a change of style or for removing the ghosting phenomenon after several updates. We recommend enabling this GU option after around 10 updates. The 1<sup>st</sup> image is fixed to run global update which cannot be changed.
- The  interval is used for delay time or update time. When  GU is checked, the value in this textbox is defined for how many milliseconds of delay time to run next image. When  GU is unchecked, the value in this textbox is defined for the eTC displays that how many milliseconds of duration to run the partial image. Checked or unchecked this is always for delay time with iTC displays. The lower the value, the more obvious ghosting image. We recommend keeping it 400ms above.

Refer to the example below how to arrange a demonstration. You will find we've selected with the GU option at the 4<sup>th</sup> image and set a white image for different sense.

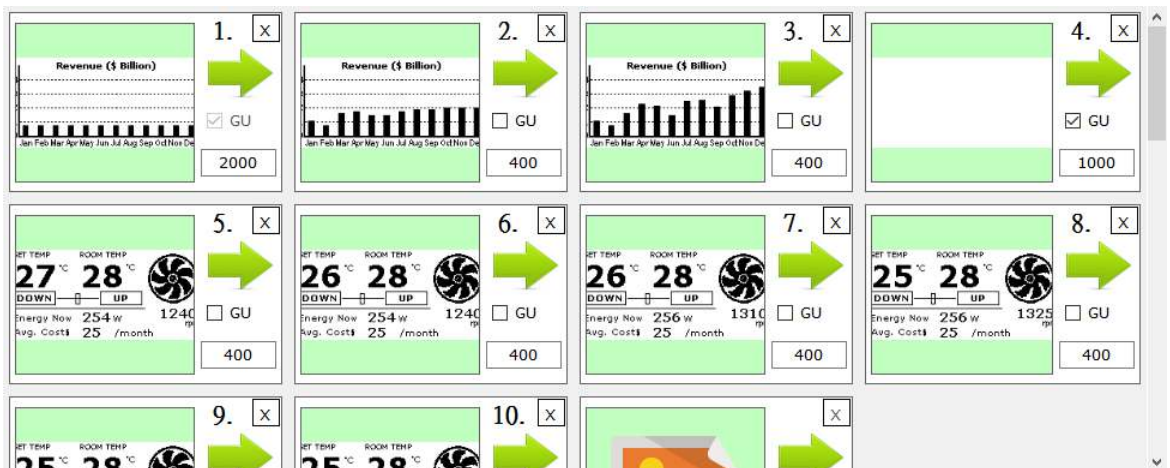

Some 2.71" demo images for fast update can be found under [My Documents\PDI Apps\images\2.71 PU] folder.

- **Upload and Run the Patterns above:**

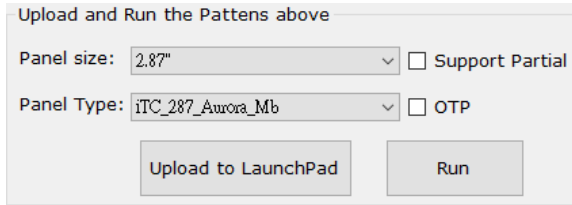

- The size of your selected images in the Image List has to match the Panel Size in this area. Please select the correct type in the second dropdown list.
- Selected with  SupportPartial to list the EPD type has supported Partial Update in the dropdown.  
If your selected EPD type hasn't supported the partial update, the connected EPD will show the images with selected GU  GU for global updates only.
- The  OTP is the same function as in previous tab to update iTC EPD by preprogrammed waveform in driver IC.
- Before you click Run button to test the arrangement, you have to upload all the images in the list to the onboard Flash memory of EXT2 board. Please click the  button to start uploading the images and you will see the progress at the bottom.
- Once completed the uploading work, click  button to see the demonstration. Every time you have changed the order, images or setting, you have to upload them again and then click Run.

- **Other Functions:**

- Set all to GU: select or deselect all  GU options in the image list
- Set all intervals to mini-seconds: set all the intervals to same defined mini-seconds in the image list.
- Clean ImageList: to clear all the images and settings in the list above.
- Save ImageList: if you would like to save the images and settings that you just created for future use, click this button to save it (as \*.pdst file).
- Load ImageList: to restore your saved image list and settings.
- Start AutoRun by Interval: after clicking this button, the images will run continuously. You can close the PDI Apps now and supply the power to LaunchPad to get the kit auto running alone with connecting with computer and PDi Apps.
- Start AutoRun by Button: after clicking this button, the image update can be controlled by the on board buttons of LaunchPad. The left button is for showing the previous image and the right button is for displaying the next image. It's also able to run this demo alone without PDi Apps and computer if you supply power to LaunchPad for demonstration.
- Stop AutoRun: to stop the auto run and disable this function.
- Download from Flash: when you want to know what images and settings had uploaded in the onboard Flash memory, this function can get back them to the list.
- Erase Flash: to erase all the data in the onboard Flash memory.

### 2.4.3 Bitmap Converter

This page is used for converting any image format to 1-bit bitmap file as image array by the resolution of selected EPD size. The output image can be saved as file to be used for our EPDs. It supports monochrome (black & white) mode and color (black, white and red) mode.

- **Input Image:**

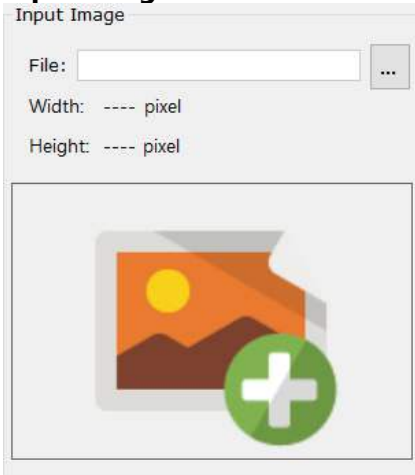

The input image supports .bmp, .jpeg, .jpg and .png image file. You will get the pixel numbers of the width and height.

- **Image Converting Type:**

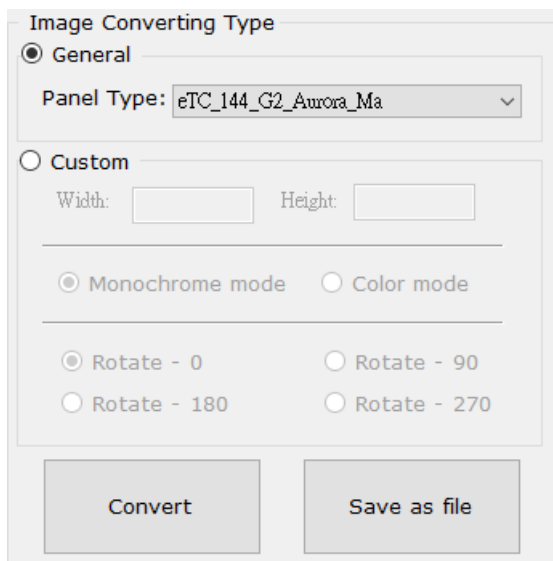

- **General:**  
 Panel Type:  to list the supported EPD type that you would like to convert from Input Image to the resolution of our standard EPDs as image array file.
- **Custom:**  
 The output resolution can be custom defined. This function will convert the Input Image to such resolution.  
 There are Monochrome mode and Color mode options to generate black/white and black/white/red image arrays.  
 You can also select the direction of rotation to turn the input image.
- **Convert:**  
 Click this button to generate the raw data at the bottom area and the output image

at the right area.

- Save as file:  
Click this button to save the raw data as image array for you to use in code for driving our EPDs.

### 3. Hardware Instructions of EXT2 Kit

From section 3 to 4, these sections are focused on more details of EXT2 hardware and software for developers to better understand how to work with EXT2 kit and further develop own products.

#### 3.1 Introduction of EXT2 board

EXT2 is the next generation of PDI’s EPD Extension kit. The EXT2 board supports driving most of the PDI’s EPD panels with different driver IC and FPC. The EXT2 board has embedded EPD driving circuit which are soldered at the backside. It also features 8M bits flash memory (U3), DIP switch (J7) and temperature sensor (U1) onboard.

Figure 3-1 EPD Extension Board Gen2 (front view)

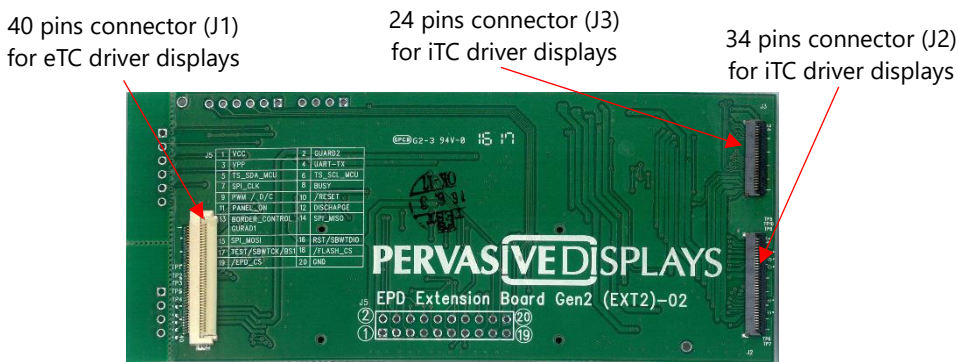
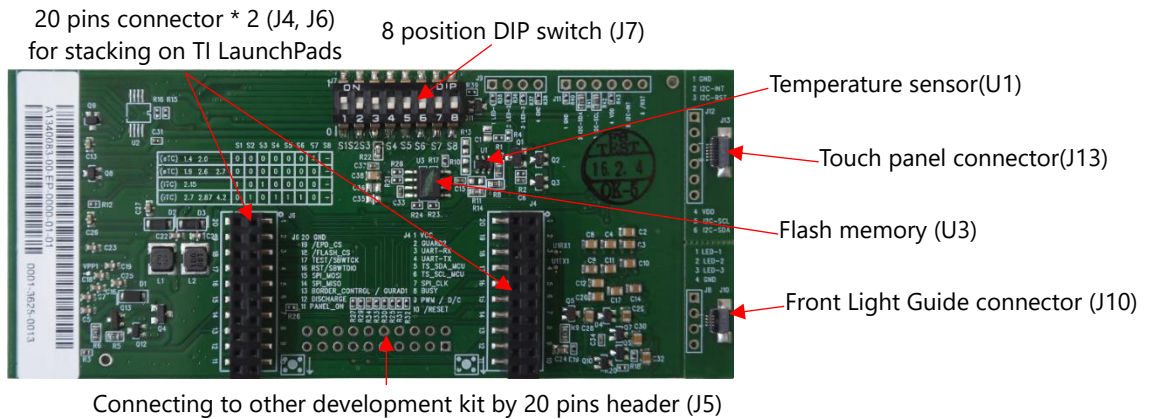

Figure 3-2 EPD Extension Board Gen2 (rear view)



There are two 20 pins connectors (J4 and J6) at the backside of EXT2 board is able to stack on TI LaunchPads. There is also 20 holes (J5) at the bottom of board for user to solder the 90 degrees 20 pins header connects with the bridging cable to any of your product or development kit working with this EXT2 board.

For further request to extend the applications, this EXT2 board has built in touch panel connector (J13) is able to control by MCU via the I<sup>2</sup>C interface. We also provide the front light guide connector (J10) to supply power if you have EPD that integrates with such function.



### 3.1.1 Headers and Connectors

- eTC EPD connector (**J1**)

This is a 40-pins 0.5mm pitch of ZIF type FPC connector to connect with PDi’s EPD that is embedded G2 COG.

For more details of the 40 pin assignment, please refer to the product specification of each size of EPD can be downloaded from PDi website.

- iTC EPD connector (**J2, J3**)

This is a **J2** 34-pins 0.5mm pitch of ZIF type FPC connector to connect with PDi’s EPD that is embedded iTC driver. The connector supports dual contact. The width of the FPC is 34-pins with 8 dummy pins.

The **J3** is a 24-pins FPC connector which is removed the pin#1~5 and pin#29~34 of J2 connector. It’s pin-to-pin (from #1 to #24) to the #6 to #29 of 34-pins connector.

For more details of the 26 pin assignment, please refer to the EPD product specification on PDi website.

- LaunchPad stacking connector (**J4 & J6**)

There are two 20-pins connectors at the backside of EXT2 board to stack on TI LaunchPad directly. We use the outer side pins only. The pin assignment is listed on the rear side of PCB.

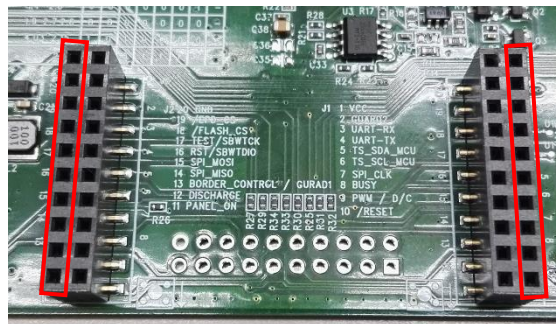

- 8 position DIP switch (**J7**)

This DIP switch is used for differentiating driver type (iTC, eTC) and different components. If you didn’t configure this switch correctly before updating the EPD, the image shows on EPD may has abnormal phenomenon like broken image, different color, wrong pixel data or ghosting.

For more details of the configuration, please refer to Table 2-1 Configuration of the DIP switch.

### 3.2 How to bridge EXT2 with other development kit

If you will use our EXT2 board to bridge with your product or other development kit, there is Bridging header (J5) which is pin-to-pin to J4 and J6. The pin assignment is listed on the front side of PCB. Please use the 90 degree 20-pins header to solder on the backside of PCB like the picture below.

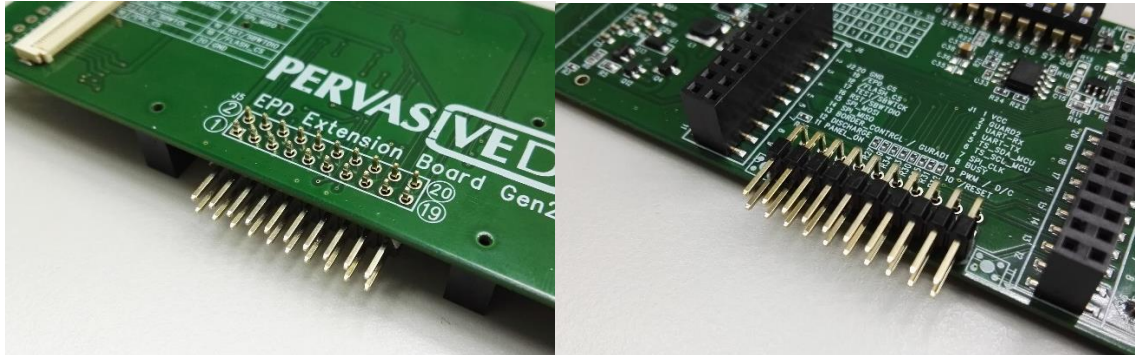

💡 We highly recommend cutting the protruding portion of the pin header in order to avoid breaking the EPD.

After soldering the header on the EXT2 board, you are able to connect the bridging cable with the pin headers of other development kit or your product.

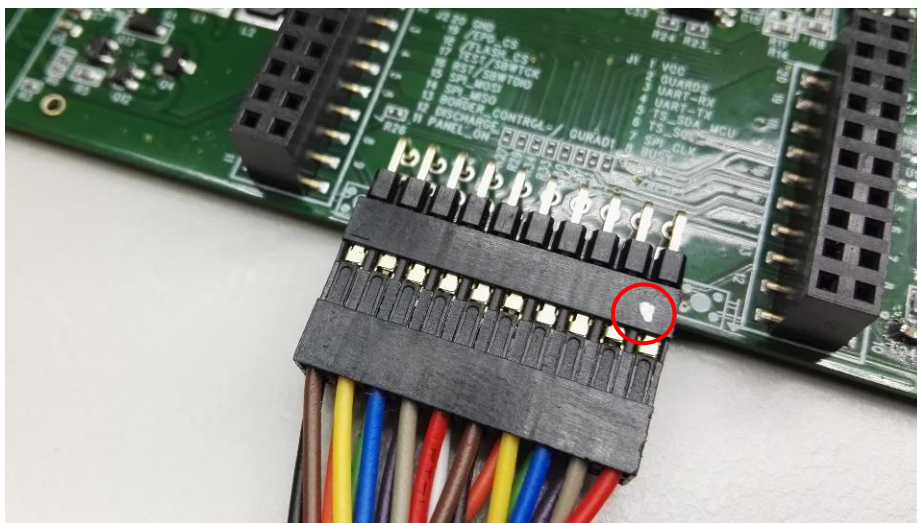
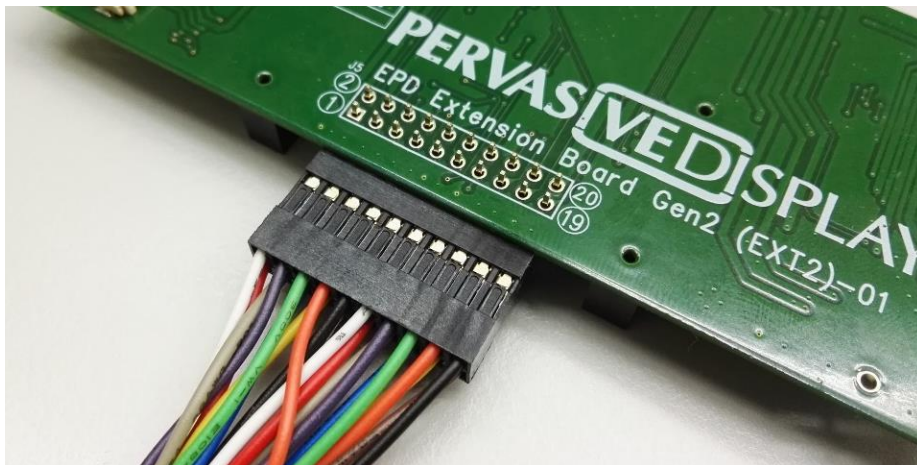

Please note there is a white dot on the connector of bridging cable indicates the pin 1.

The pin assignment is listed below.

**Table 3-1 Pin assignment of EXT2 header**

Jumper	Pin No.	Name	Description
J4, J5	1	VCC	Target supply voltage
	2	GUARD2	TFT Breakage detection (option)
	3	VPP	Power Supply for OTP Programming
	4	UART-TX	LaunchPad default pin
	5	TS_SDA_MCU	I <sup>2</sup> C data for external temperature sensor (GPIO)
	6	TS_SCL_MCU	I <sup>2</sup> C clock for external temperature sensor (GPIO)
	7	SPI_CLK	Clock for SPI
	8	BUSY	COG busy pin (GPIO)
	9	D/C	Data/Command control for iTC (GPIO)
	10	/RESET	Reset signal. Low enable (GPIO)
J5, J6	11	PANEL_ON	COG driver power control pin (GPIO)
	12	DISCHARGE	EPD discharge when EPD power off (GPIO)
	13	BORDER_CONTROL (GUARD1)	Border control pin for eTC (GPIO) Breakage detection (option)
	14	SPI_MISO	Serial output from EPD to host MCU
	15	SPI_MOSI	Serial input from host MCU to EPD
	16	RST/SBWTIO	LaunchPad default pin
	17	TEST/SBWTCK	LaunchPad default pin
	18	/FLASH_CS	On board flash chip select (GPIO)
	19	/EPD_CS	Chip Select. Low enable (GPIO)
	20	GND	Ground

### 3.3 Integration with front light guide

Light guide connector (**J8, J9, J10**).

There are V-cut lines arranged on the EXT2 board. If you will connect the EPD with front light guide to EXT2 board, you have to cut off the small PCBs and wiring by yourself.

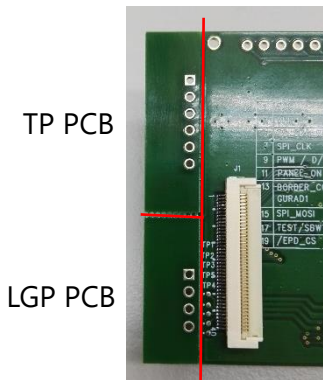

We define the upper PCB is touch panel PCB (**TP PCB**) and the lower one is light guide plate PCB (**LGP PCB**).

The defined pin-out of LGP PCB is listed below.

Pin No.	Description
1	LED-1
2	LED-2
3	LED-3
4	GND

It depends on how far of the FPC connector of the light guide on EPD to the LGP PCB. The LED-1 to 3 are supplied by 3V. Please jumper wiring the pins to EXT2 onboard like the drawing below.

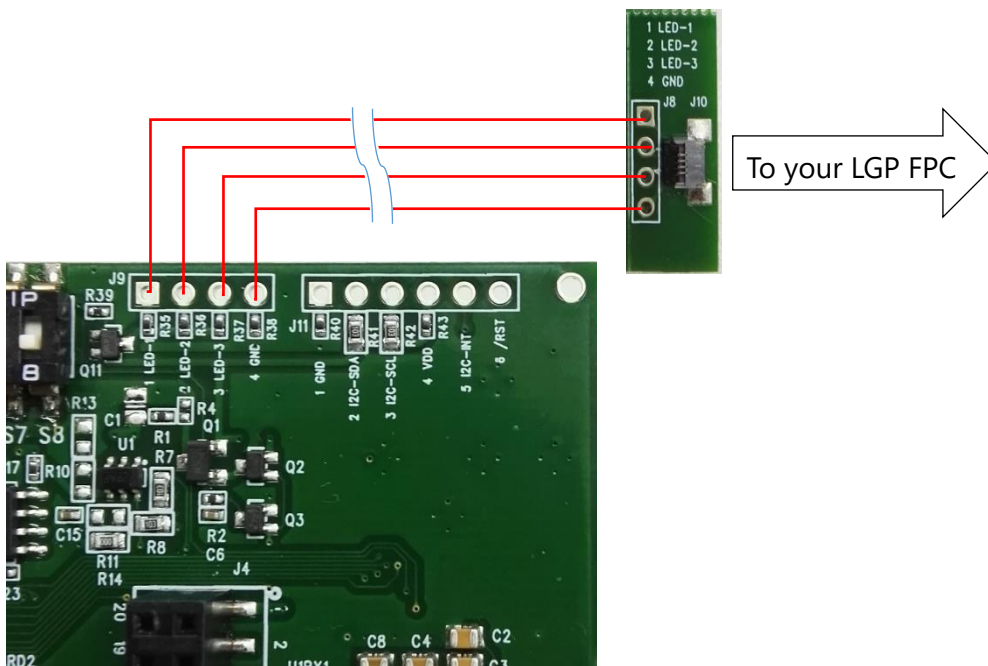

### 3.4 Integration with touch panel

Touch panel connector (J11, J12, J13)

If you will connect the EPD with touch panel to EXT2 board, you have to cut off the small PCBs and wiring by yourself. The defined pin-out of touch panel is listed below.

Pin No.	Description
1	GND
2	I <sup>2</sup> C-INT
3	/RSTN
4	VDD-3.3V
5	I <sup>2</sup> C-SCL
6	I <sup>2</sup> C-SDA

It depends on how far of the FPC connector of the touch panel on EPD to the TP PCB. Please jumper wiring the pins to EXT2 onboard like the drawing below.

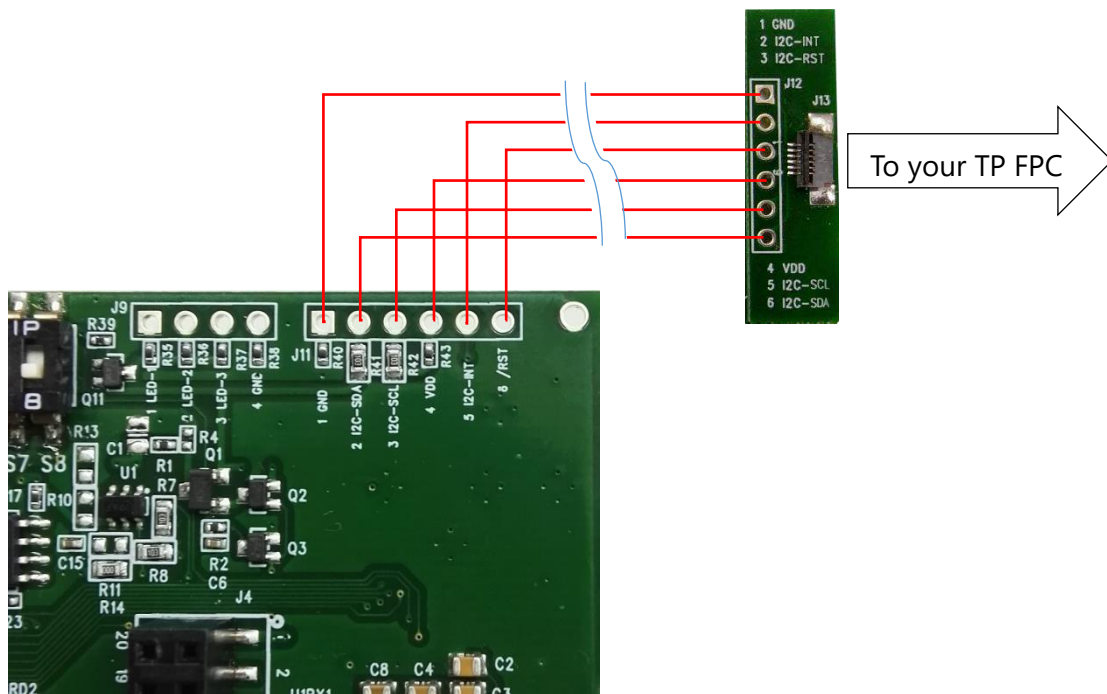

### 3.5 Integration with Large size EPD(9.7"/12")

About Large size EPD(9.7"/12"), we can offer the EPD with one FPC connection(24 pins) or 2 FPCs connection solution, please contact us if you can not find the suitable EPD from your vendor.

If we take 9.7" EPD as an example, you can find the different connection between 1 FPC and 2 FPCs from the below pictures,

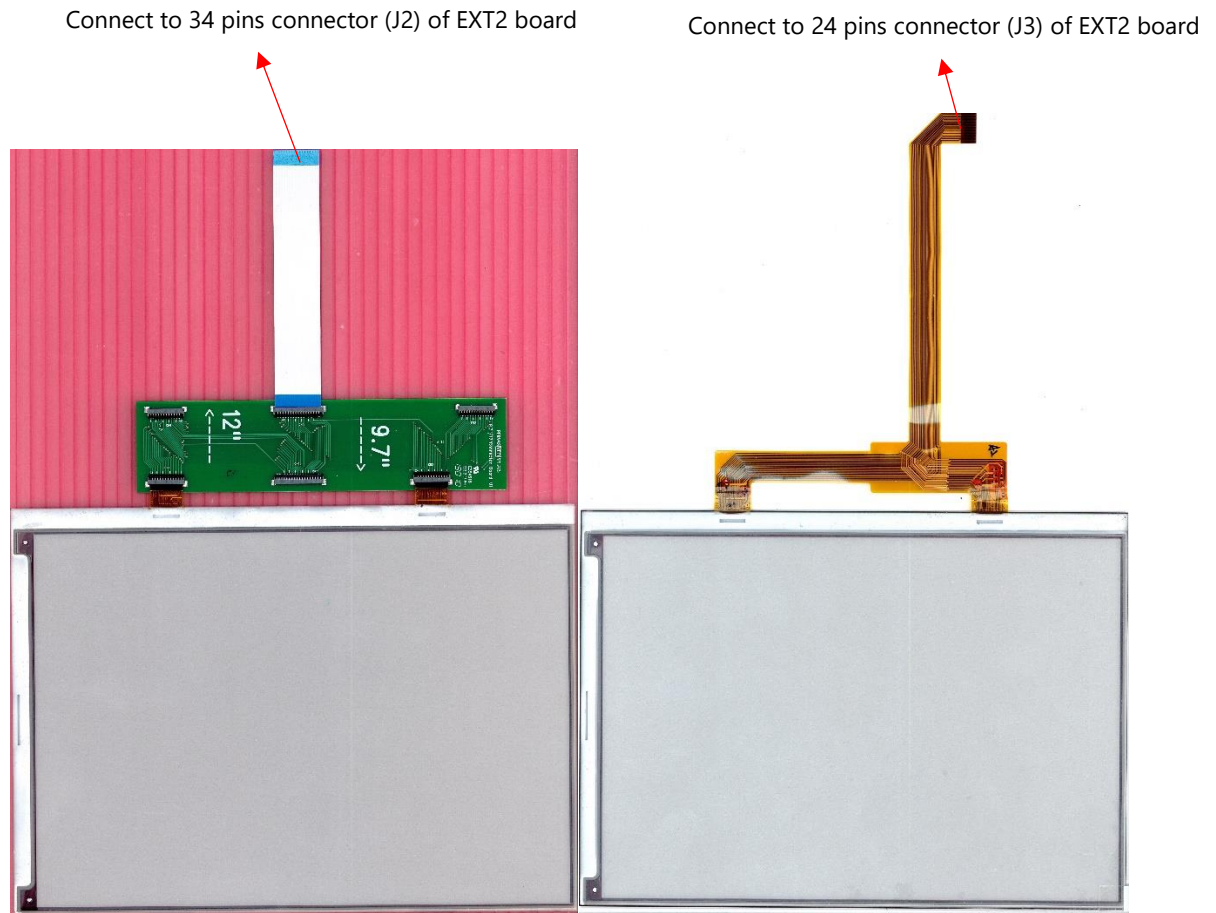

## 4. Working with TI CCS Project Code

As you can find there are many configurations in the projects which are PDi Apps and some Single drivers. The **Single driver** means it's not working with PDi Apps and will toggle between two images right away after debugging the project. It helps you to simply test the basic global update function with your connected EPD. It's also the driving waveform that you will migrate to your product using the chosen EPD.

 The descriptions in this section will focus on the single driver.

The project model in the CCS project consists of the main project "EPD\_drivers" and some supported *LaunchPad\_name* projects.

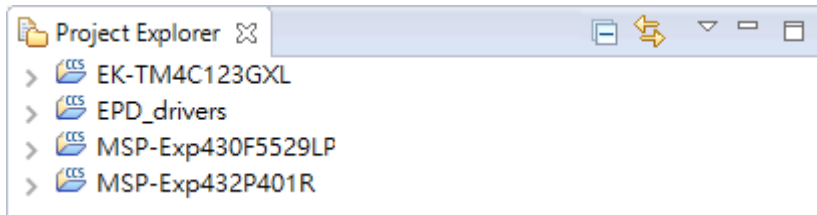

### 4.1 EPD\_drivers Project

All of the driving waveform source code of supported EPDs with different FPL and driver are placed in this project including the API (application interface).

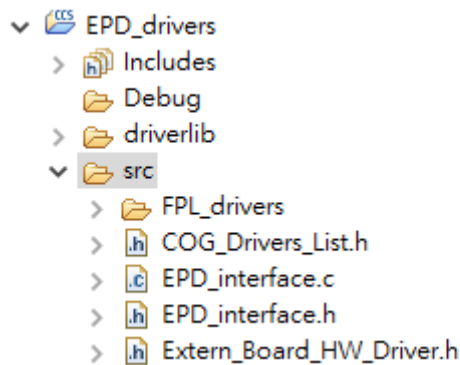

- **FPL\_drivers** folder:

You can find all the driving code under this folder for your chosen EPD. If you cannot find the model in this folder, please contact us to request the driving source code.

The more advanced version of the project, the more driving code of EPDs will be supported under this folder. You will find the file format is like the configuration that we describe before:

***DriverType\_(DriverID if eTC)\_Size\_FPL***

The captured picture below is for example. Your project code may be listed less or more than the example.

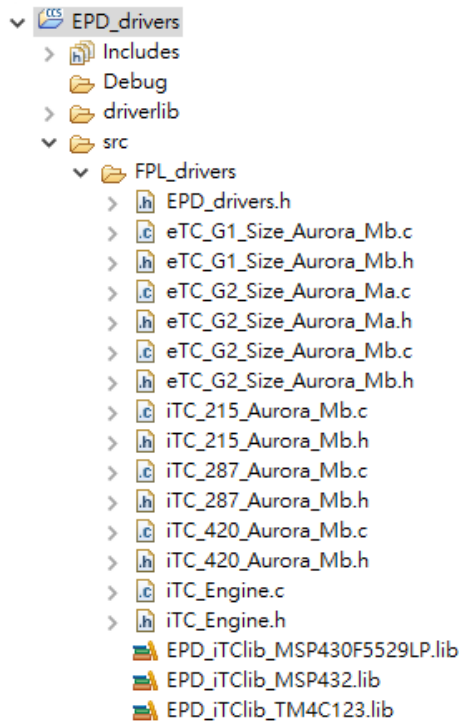

- **EPD\_drivers.h:**  
This file defines the main structures of EPD and COG type, the enumerations and the constants.
- **DriverType\_Size\_FPL.\*:**  
The most of driving source code for each supported EPD including the power on, initialization, update and power off stages. This is the waveform code you will migrate into your project for driving your chosen EPD.  
Please note the LUT for iTC EPDs are compiled in the library (.lib file) with each Launchpad. The code in the iTC\_\*.c file is for sending update command by OTP.
- **iTC\_Engine.\*:**  
This file is used for iTC EPDs. In each of iTC\_Size\_FPL.c file, the code will always call functions from this iTC\_Engine.c to extract the arrays (LUT) to get the corresponding data and set to each of predefined constant for later use.
- **COG\_Drivers\_List.h** file:  
This file defines the driver list and functions that will be supported in each of LaunchPad project.
- **EPD\_interface.\*** file:  
The main function interfaces for each project to call with.
- **Extern\_Board\_HW\_Driver.h** file:  
If you want to compile the “EPD\_drivers” project as library, you need this file to compile with together.



## 4.2 LaunchPad Name Project

In MSP-Exp430F5529LP project, we have copied the driver files in [driverlib] folder. If there is new update from F5529 LaunchPad, you can copy the driver files into this folder.

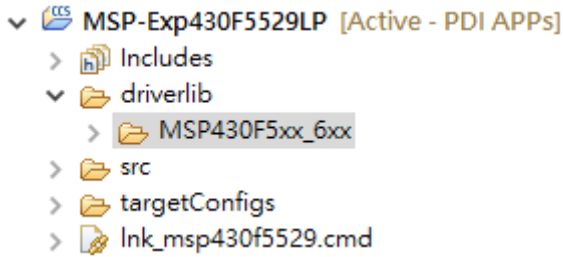

In MSP-Exp432P401R and EK-TM4C123GXL projects, we have linked the drivers with your local installed MSPWare and TivaWare folder. (Refer to section 2.2.4)

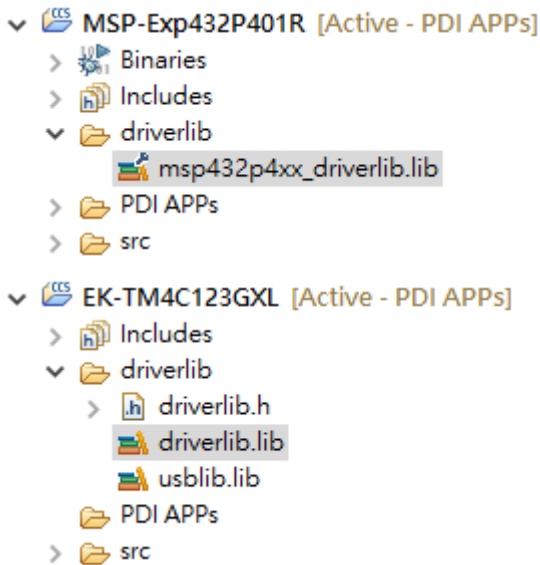

The folder structure in [src] folder of each LaunchPad project is same. The included or excluded files depends on which configuration you've set.

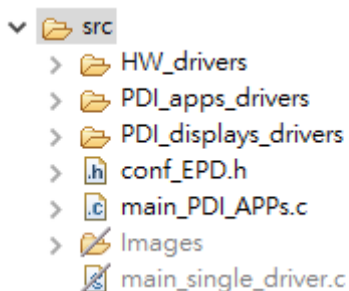

- **HW\_drivers** folder:

Under this folder, you will find the most important driver files to work with the LaunchPad. If you will bridge the EXT2 to other development kit or your product, these files are the keys to modify with.

- Board\_HW\_Driver: defining and configuring all the GPIO pins including SPI and timer.
- EPD\_Temperature\_IIC: set and get the temperature from the onboard S5851AAA sensor via I<sup>2</sup>C interface.
- Flash\_Mem\_Map: get the block and address from the onboard serial Flash memory

MX25V8005.

- Mem\_Flash: access with the onboard serial Flash memory MX25V8005.
- Ringbuf: set the ring buffer (FIFO) for transmission and reception.
- UART\_Driver: configure and control with the UART interface.
- **PDI\_apps\_drivers** folder:

The functions and modules to work with the PDi Apps utility. To understand the functionalities, you have to get the source project code of PDi Apps and understand the operating commands and data flow between PDi Apps and these files under this folder.

The source codes are linked from the physical project folder under root/PDI\_apps\_drivers.

- **PDI\_displays\_drivers** folder:

The files under this folder are linked from **EPD\_drivers** project to get synchronization for the EPD driving.

- **Conf\_EPD.h** file:

This file is used for single driver mode only (it doesn't work with PDi Apps mode).

- Once you set the Active configuration from project in CCS to "eTC\_G2\_\*" like the capture below, you will need to configure this file when in single driver mode.

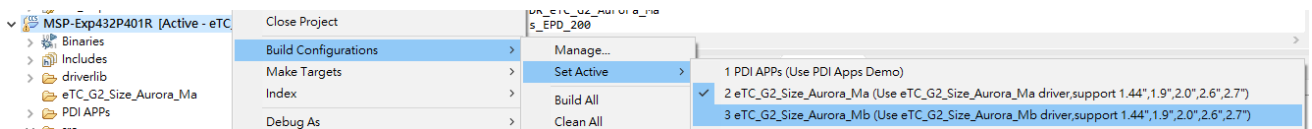

- You can skip the definition if you set the other "iTC\_\*" configuration in single driver mode.
- Check the EPD size of your connected eTC display, find the non-gray area and the "#define USE\_EPD\_SIZE s\_EPd\_200" line, change the s\_EPd\_200 to size you are connected.

```

55 #ifndef eTC_G1_Aurora_Mb
56 #define USE_COG_Driver    DR_eTC_G1_Aurora_Mb
57 #define USE_EPd_SIZE      s_EPd_200
58 #endif
59 #ifndef eTC_G2_Aurora_Ma
60 #define USE_COG_Driver    DR_eTC_G2_Aurora_Ma
61 #define USE_EPd_SIZE      s_EPd_200
62 #endif
63 #ifndef eTC_G2_Aurora_Mb
64 #define USE_COG_Driver    DR_eTC_G2_Aurora_Mb
65 #define USE_EPd_SIZE      s_EPd_200
66 #endif
    
```

Options are sEPD\_144 for 1.44", sEPD\_190 for 1.9", sEPD\_200 for 2.0", sEPD\_260 for 2.6" and sEPD\_271 for 2.71" (2.7").

- **Main\_single\_driver.c** file:

The main file for selecting single driver mode.

- **Main\_PDI\_APPS.c** file:

The main file for selecting PDi Apps mode.

## 5. Document revision history

Rev.	Date	Comment
01	31 Mar, 2016	<ul style="list-style-type: none"> <li>- First release</li> <li>- Supported driving eTC: 1.44", 1.9", 2.0", 2.6" and 2.71". iTC: 2.15"</li> </ul>
02	17 Jun, 2016	<ul style="list-style-type: none"> <li>- Added supporting 4.2" iTC</li> <li>- The PDi Apps supports 2.15" iTC and 4.2" iTC for partial update.</li> <li>- The "TIVAWAREDLIB_ROOT" of Build Variables of EK-TM4C123GXL is revised to String type at page 20.</li> </ul>
03	5 Aug, 2016	<ul style="list-style-type: none"> <li>- Added supporting 2.87" iTC</li> <li>- The PDi Apps supports 2.87" iTC for partial update.</li> <li>- List the up-to-date library version for each LaunchPads since the project code released.</li> </ul>
04	7 Oct, 2016	<ul style="list-style-type: none"> <li>- Added the description of code size limitation of MSP430 at page 20.</li> <li>- Added supporting 2.87" Spectra and 4.2" Spectra displays.</li> <li>- Added changing image by clicking the on-board buttons of LaunchPad in the [Fast Update] of PDi Apps.</li> <li>- Change the description for the checkbox of GU in the fast update.</li> </ul>
05	10 Jul, 2017	<ul style="list-style-type: none"> <li>- Changed Model name of EXT2 Kit to B3000MS034(24 pin connector supported)</li> <li>- Changed EXT2 Kit picture and instruction</li> <li>- Added EC-type EPD on Supported EPD Display Lineup</li> </ul>
06	25 Dec, 2017	<ul style="list-style-type: none"> <li>- Added 1.54"/2.13"/2.66"/2.71" iTC EPD on Supported EPD Display Lineup</li> <li>- Updated Uniflash user interface</li> <li>- Updated TivaWare library version</li> </ul>
07	15 May, 2018	<ul style="list-style-type: none"> <li>- Added 12.2" iTC EPD on Supported EPD Display Lineup</li> </ul>
08	11 Nov, 2019	<ul style="list-style-type: none"> <li>- Changed Model name of EXT2 Kit to B3000MS035</li> <li>- Added 3.7"/4.37"/5.8"/7.4"/9.7" iTC EPD on Supported EPD Display Lineup</li> <li>- Added B/W/yellow on the table</li> <li>- Added Large size(9.7"/12") connection board/24pin FFC</li> <li>- Added 3.5 Integration with Large size EPD(9.7"/12")</li> </ul>

## 6. Evaluation board/kit important notice

This evaluation board/kit is intended for use **for FURTHER ENGINEERING, DEVELOPMENT, DEMONSTRATION, OR EVALUATION PURPOSES ONLY**. It is not a finished product and may not (yet) comply with some or any technical or legal requirements that are applicable to finished products, including, without limitation, directives regarding electromagnetic compatibility, recycling (WEEE), FCC, CE or UL (except as may be otherwise noted on the board/kit). Pervasive Displays (PDi) supplied this board/kit "AS IS," without any warranties, with all faults, at the buyer's and further users' sole risk. The user assumes all responsibility and liability for proper and safe handling of the goods. Further, the user indemnifies PDi from all claims arising from the handling or use of the goods. Due to the open construction of the product, it is the user's responsibility to take any and all appropriate precautions with regard to electrostatic discharge and any other technical or legal concerns.

EXCEPT TO THE EXTENT OF THE INDEMNITY SET FORTH ABOVE, NEITHER USER NOR PDI SHALL BE LIABLE TO EACH OTHER FOR ANY INDIRECT, SPECIAL, INCIDENTAL, OR CONSEQUENTIAL DAMAGES.

No license is granted under any patent right or other intellectual property right of PDi covering or relating to any machine, process, or combination in which such PDi products or services might be or are used.



**Pervasive Displays Inc.** 4F, No. 28, Chuangye Rd., Tainan Science Park, Tainan City (74144) Taiwan (R.O.C.) T: (+886)(6) 2795399

Disclaimer: The information in this document is provided in connection with Pervasive Displays (PDi) products. No license, express or implied, by estoppel or otherwise, to any intellectual property right is granted by this document or in connection with the sale of PDi products. EXCEPT AS SET FORTH IN THE PDI TERMS AND CONDITIONS OF SALES LOCATED ON THE PDI WEBSITE, PDI ASSUMES NO LIABILITY WHATSOEVER AND DISCLAIMS ANY EXPRESS, IMPLIED OR STATUTORY WARRANTY RELATING TO ITS PRODUCTS INCLUDING, BUT NOT LIMITED TO, THE IMPLIED WARRANTY OF MERCHANTABILITY, FITNESS FOR A PARTICULAR PURPOSE, OR NON-INFRINGEMENT. IN NO EVENT SHALL PDI BE LIABLE FOR ANY DIRECT, INDIRECT, CONSEQUENTIAL, PUNITIVE, SPECIAL OR INCIDENTAL DAMAGES (INCLUDING, WITHOUT LIMITATION, DAMAGES FOR LOSS AND PROFITS, BUSINESS INTERRUPTION, OR LOSS OF INFORMATION) ARISING OUT OF THE USE OR INABILITY TO USE THIS DOCUMENT, EVEN IF PDI HAS BEEN ADVISED OF THE POSSIBILITY OF SUCH DAMAGES. PDi makes no representations or warranties with respect to the accuracy or completeness of the contents of this document and reserves the right to make changes to specifications and products descriptions at any time without notice. PDi does not make any commitment to update the information contained herein. Unless specifically provided otherwise, PDi products are not suitable for, and shall not be used in, automotive applications. PDi products are not intended, authorized, or warranted for use as components in applications intended to support or sustain life.