Title	<i>Reference Design Report for a 4.5 W Non-Dimmable, High Efficiency (>87%), Power Factor Corrected, Non-Isolated Buck LED Driver Using LYTSwitch™-1 LYT1402D</i>
Specification	90 VAC – 300 VAC Input; 48 V _{TYP} , 95 mA _{TYP} Output
Application	Candelabra (E12) Bulb
Author	Applications Engineering Department
Document Number	RDK-465
Date	August 4, 2016
Revision	1.0

Summary and Features

- Single-stage power factor corrected, PF >0.8 at 115 V and 230 V
- Accurate constant current regulation, ±5%
- Meets <30% flicker percent requirement
- Highly energy efficient, >87% at 115 V and 230 V
- Low cost and low component count for compact PCB solution
- Integrated auto-restart protection features
 - No-load / open-load output
 - Output short-circuit
 - Line surge or line overvoltage
- Thermal foldback for power reduction
- Over temperature shutdown with hysteretic automatic power recovery
- No damage during line brown-out or brown-in conditions
- Meets IEC 2.5 kV ring wave, 500 V differential surge
- Meets EN55015 conducted EMI

PATENT INFORMATION

The products and applications illustrated herein (including transformer construction and circuits external to the products) may be covered by one or more U.S. and foreign patents, or potentially by pending U.S. and foreign patent applications assigned to Power Integrations. A complete list of Power Integrations' patents may be found at www.powerint.com. Power Integrations grants its customers a license under certain patent rights as set forth at <http://www.powerint.com/ip.htm>.



Table of Contents

1	Introduction	5
2	Power Supply Specification	7
3	Schematic	8
4	Circuit Description	9
4.1	Input Stage	9
4.2	EMI Filter	9
4.3	LYTSwitch-1 Control Circuit	9
5	PCB Layout	12
6	Bill of Materials	13
7	Inductor Specification	14
7.1	Electrical Diagram	14
7.2	Electrical Specifications	14
7.3	Material List	14
7.4	Inductor Build Diagram	15
7.5	Inductor Construction	15
7.6	Winding Illustrations	16
8	Inductor Design Spreadsheet	18
9	Performance Data	20
9.1	Efficiency	20
9.2	Line Regulation	21
9.3	Power Factor	22
9.4	%ATHD	23
9.5	Individual Harmonics Content	24
10	Test Data	26
10.1	Test Data, 43 V LED Load	26
10.2	Test Data, 46 V LED Load	26
10.3	Test Data, 49 V LED Load	26
10.4	Test Data, Harmonic Content at 115 VAC, 48 V LED Load	27
10.5	Test Data, Harmonic Content at 230 VAC, 48 V LED Load	28
11	Thermal Performance	29
11.1	Thermal Performance Scan – Open Frame Unit	29
11.1.1	Thermal Scan at Normal Operation 90 VAC, 48 V LED Load	30
11.1.2	Thermal Scan at Normal Operation 115 VAC, 48 V LED Load	32
11.1.3	Thermal Scan at Normal Operation 230 VAC, 48 V LED Load	34
11.1.4	Thermal Scan at Normal Operation 300 VAC, 48 V LED Load	36
11.1.5	Thermal Scan During Output Short-Circuit at 115 VAC Input	38
11.1.6	Thermal Scan During Output Short-Circuit at 230 VAC Input	39
11.2	Thermal Performance at 85 °C Ambient	40
11.2.1	Thermal Performance at 90 VAC with a 48 V LED Load	41
11.2.2	Thermal Performance at 115 VAC with a 48 V LED Load	42
11.2.3	Thermal Performance at 230 VAC with a 48 V LED Load	44
11.2.4	Thermal Performance at 300 VAC with a 48 V LED Load	46

12	Waveforms	47
12.1	Input Voltage and Input Current Waveforms	47
12.2	Start-up Profile	48
12.3	Output Current Fall	50
12.4	Drain Voltage and Current in Normal Operation	51
12.5	Drain Voltage and Current Start-up Profile.....	53
12.6	Drain Voltage and Current During Output Short-Circuit	54
12.7	Output Diode Voltage and Current in Normal Operation	55
12.8	Output Voltage and Current – Open Output LED Load.....	56
12.9	Output Voltage and Current – Start-up at Open Output Load.....	57
12.10	Output Ripple Current.....	58
13	AC Cycling Test.....	60
14	Conducted EMI	62
14.1	Test Set-up	62
14.1.1	Equipment and Load Used	62
14.2	EMI Test Result	63
15	Line Surge	65
16	Brown-in / Brown-out Test	66
17	Revision History	67

Important Note: Although this board is designed to satisfy safety isolation requirements, the engineering prototype has not been agency approved. Therefore, all testing should be performed using an isolation transformer to provide the AC input to the prototype board.

1 Introduction

This engineering report describes a low component count, non-isolated, non-dimmable LED driver in buck topology, designed to drive a 48 V LED voltage string at 95 mA output current from an input voltage range of 90 VAC to 300 VAC. The LED driver utilizes the LYT1402D from the LYTSwitch-1 family of devices.

LYTSwitch-1 is a SO-8 package LED driver controller IC designed for non-isolated buck topology applications. The LYTSwitch-1 provides high efficiency, high power factor and accurate LED current regulation. LYTSwitch-1 incorporates a high-voltage power MOSFET and variable frequency / variable on-time, critical conduction mode control engine for tight current regulation, high power factor and proprietary MOSFET utilization for high efficiency. The controller also integrates protection features such as input and output overvoltage protection, thermal fold-back, over temperature shutdown, output short-circuit and overcurrent protection.

RDK-465 offers a compact size solution for 4.5 W LED drivers ideal for bulb applications. The key design goals were high efficiency, accurate constant current regulation and low component count.

The document contains the power supply specification, schematic, bill of materials, transformer documentation, printed circuit layout, design spreadsheet, and performance data.



Figure 1 – Populated Circuit Board.

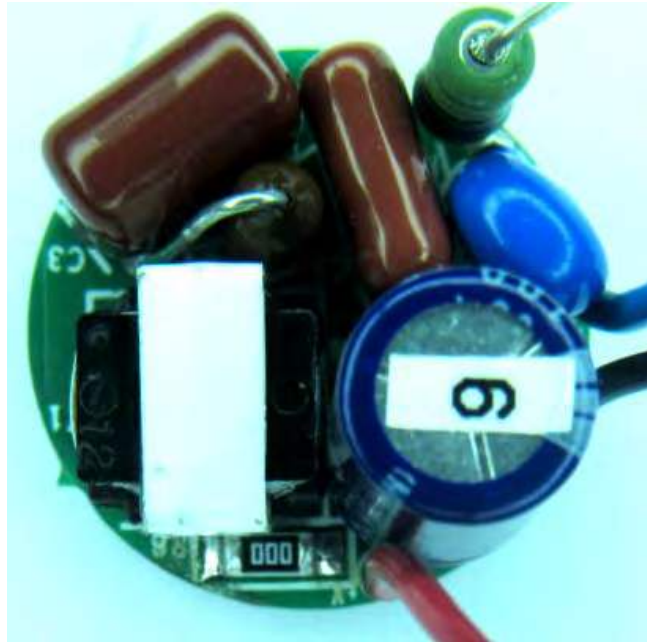

Figure 2 – Populated Circuit Board, Top View.

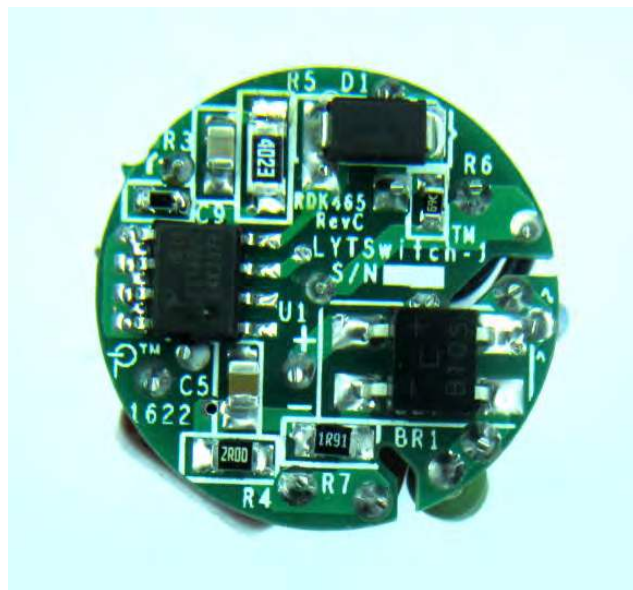

Figure 3 – Populated Circuit Board, Bottom View.

2 Power Supply Specification

The table below represents the minimum acceptable performance of the design. Actual performance is listed in the results section.

Description	Symbol	Min	Typ	Max	Units	Comment
Input Voltage	V_{IN}	90	230	300	VAC	2 Wire – no P.E.
Frequency	f_{LINE}		50		Hz	
Output Voltage	V_{OUT}		48		V	
Output Current	I_{OUT}		95		mA	
Total Output Power						
Continuous Output Power	P_{OUT}		4.5		W	
Efficiency						230 V / 50 Hz at 25 °C. 115 V / 60 Hz at 25 °C.
Full Load	η		87		%	
Environmental						
Conducted EMI						
Safety						
Ring Wave (100 kHz)			2.5		kV	
Differential Mode (L1-L2)			0.5		kV	
Power Factor			0.8			Measured at 115 VAC / 60 Hz. Measured at 230 VAC / 50 Hz.
Ambient Temperature	T_{AMB}		85		°C	Free Convection, Sea Level.

3 Schematic

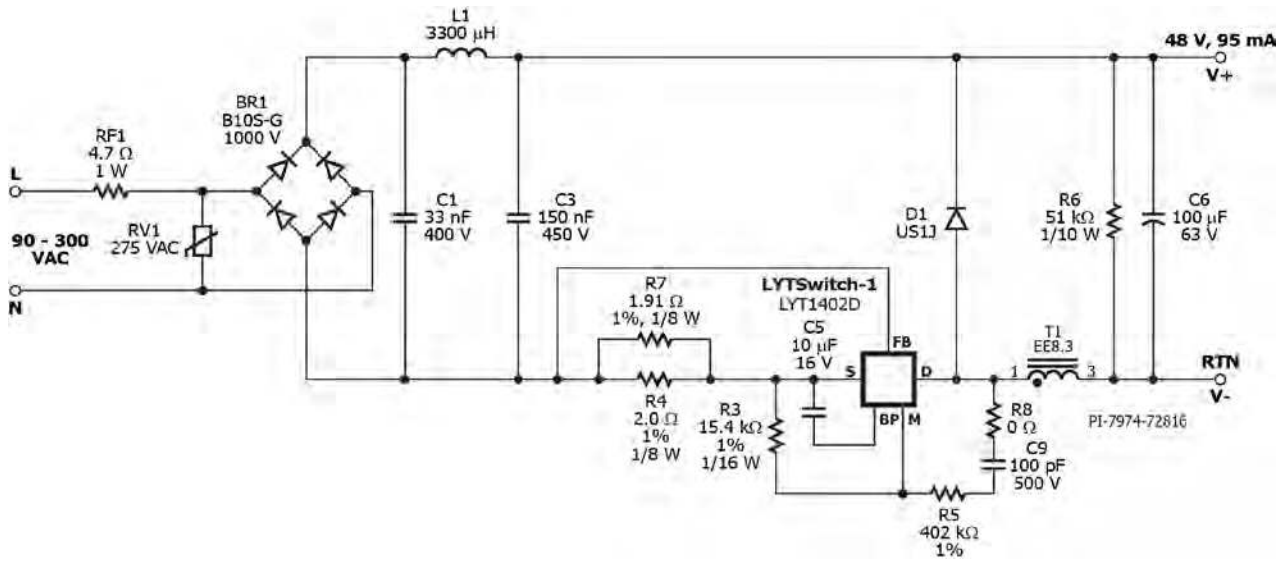

Figure 4 – Schematic.

4 Circuit Description

The LYTSwitch-1 device (U1-LYT1402D) combines a high-voltage power MOSFET and variable frequency / variable on-time, critical conduction mode controller in a single SO-8 package. LYT1402D is configured to drive a 48 V output non-isolated buck LED driver with 95 mA constant current output. The LYT1402D device was selected from the power table based on maximum output power in the datasheet.

4.1 *Input Stage*

The input fuse RF1 provides safety protection. Varistor RV1 acts as a voltage clamp that limits the voltage spike on the primary during line transient voltage surge events. The AC input voltage is full wave rectified by BR1 to achieve good power factor and low THD. For higher surge requirement such as >500 V, C1 and L1 can be placed before the bridge rectifier BR1, but a safety X-capacitor is required for C1.

4.2 *EMI Filter*

Inductor L1 serves as differential choke. Inductor L1, C1 and C3 capacitors form an EMI pi filter which works to filter differential and common mode noise. LYTSwitch-1's variable frequency/on-time states and critical conduction mode control engine limit RFI emission to significantly low levels which enables design to use simple EMI pi filter even for high power bulb and tube applications.

4.3 *LYTSwitch-1 Control Circuit*

The LED driver circuit topology is a low side buck configuration, where the MOSFET of U1 and the inductor L1 are connected to the ground rail. When the MOSFET switches ON, the current will begin to increase and will be flowing through the load via the inductor. During this time the inductor stores energy in the form of magnetic field. When the MOSFET switches OFF, the energy stored in the magnetic field around the inductor is released back into the circuit. During this time current will be flowing through the load via the inductor and the flywheel diode D1.

The output capacitor C6 provides output voltage ripple filtering to minimize the output ripple current. To avoid long ghosting effect of light output after power off, resistor R6 preload discharges the output capacitor voltage below the LED voltage.

Capacitor C5 provides local decoupling for the BYPASS (BP) pin of U1, which provides power to the IC during the switch on time. The IC internal regulator draws power from high voltage DRAIN (D) pin and charges the bypass capacitor C5 during the power switch off time. The typical BP pin voltage is 5.22 V. To keep the IC operating normally especially during the dead zone, where $V_{IN} < V_{OUT}$, the value of capacitor should be large enough to keep the BP voltage above the $V_{BP (RESET)}$ reset value of 4.5 V. Recommended minimum value for the BP capacitor is 4.7 μ F.

Constant output current regulation is achieved through the FEEDBACK (FB) pin which senses the drain current through current sense resistors (R_{FB}) R4 and R7. The voltage across the current sense resistors is then compared to a fixed internal reference voltage (V_{FB_REF}) of absolute value 280 mV typical.

$$R_{FB} = V_{FB_REF} / k \times I_{OUT}$$

Where: k is the ratio between I_{PK} and I_{OUT} ; such that k = 3 for LYT14xx, and k = 3.6 for LYT16xx)

In some cases, trimming R_{FB} is necessary to center I_{OUT} at the nominal input voltage.

The MULTIFUNCTION (M) pin monitors the line for any line overvoltage event. When the internal MOSFET is in on-state, the M pin is shorted internally to SOURCE (S) pin in order to detect the rectified input line voltage. Input line OVP can be computed from the voltage across the inductor when the MOSFET switches ON, i.e. ($V_{IN} - V_{OUT}$) and the current flowing out of the M pin via resistor R5. Thus line overvoltage detection is calculated as; where R5 is assumed to be 402 k Ω \pm 1%.

$$V_{LINE_OVP} = I_{IOV} \times R5 + V_{OUT}$$

Once the measured current exceeds the input overvoltage threshold (I_{IOV}) of 1 mA typical, the IC will inhibit switching instantaneously and initiate auto-restart to protect the internal MOSFET of the IC.

The M pin also monitors the output for any overvoltage and undervoltage event. When the internal MOSFET is in off-state, the output voltage is monitored through a coupling capacitor (C9) and divider resistors R5 and R3. When an output open-load condition occurs, the voltage at the M pin will rise abruptly and when it exceeds the threshold of 2.4 V, the IC will inhibit switching instantaneously and initiate auto-restart to limit the output voltage from further rising. The overvoltage cut-off is typically 120% of the output voltage, which is equivalent to 2 V at the M pin ($V_{OUT_OVP} = V_{OUT} \times 2.4 \text{ V} / 2 \text{ V}$). Resistors R5 and R8 are set to a total fixed value of 402 k Ω \pm 1% and R3 will determine the output overvoltage limit. Any output short circuit at the output will be detected once the M pin voltage falls below the undervoltage threshold (V_{OUV}) of 1 V typical, then the IC will inhibit switching instantaneously and initiate auto-restart to limit the average input less than 1 W, preventing any components from overheating.

Resistor R3 can be calculated as follows:

$R3 = 2 \text{ V} \times R5 / (V_{OUT} - 2 \text{ V})$; this is applicable only to low-side configuration buck.



Another function of the M pin is for zero current detection (ZCD). This is to ensure operation in critical conduction mode. The inductor demagnetization is sensed when the voltage across the inductor begins to collapse towards zero as flywheel diode (D1) conduction expires.



5 PCB Layout

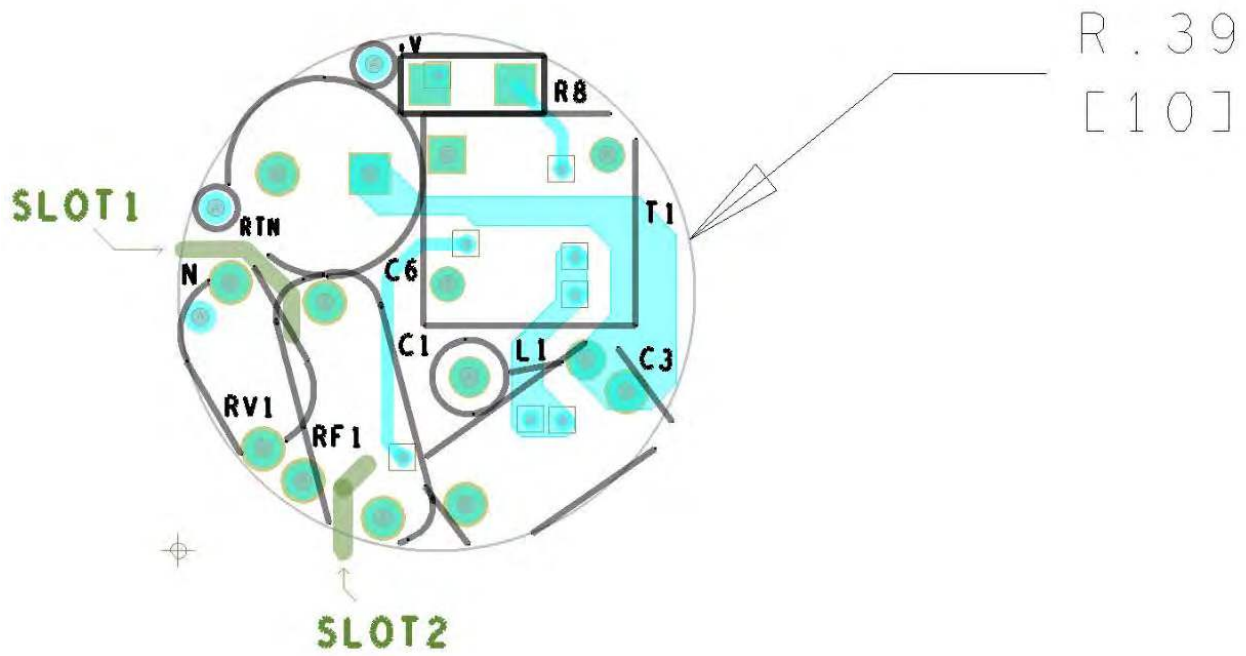

Figure 5 – Top Side.

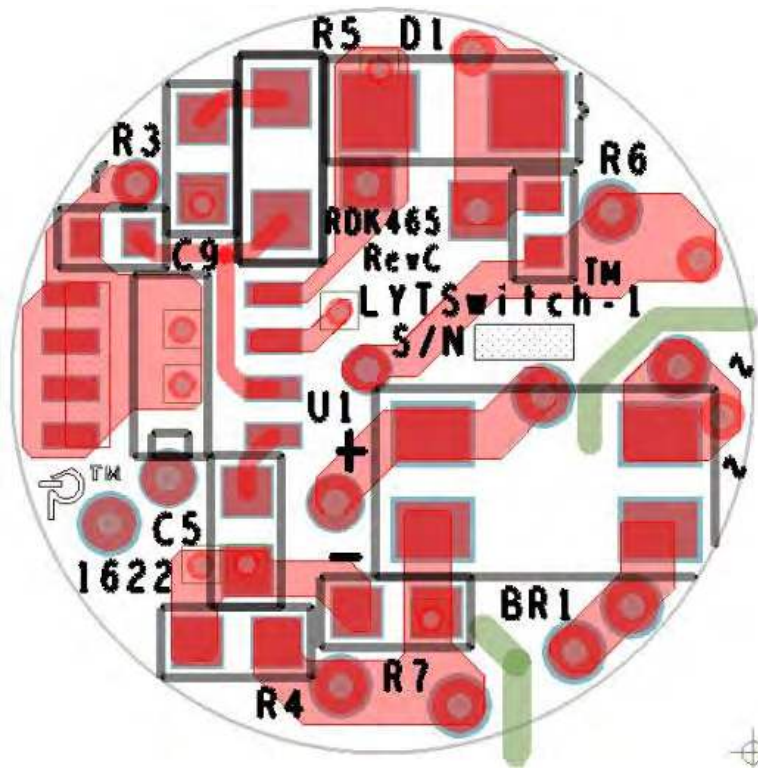

Figure 6 – Bottom Side.

6 Bill of Materials

Item	Ref Des	Qty	Description	Mfg Part Number	Manufacturer
1	BR1	1	1000 V, 0.8 A, Bridge Rectifier, SMD, MBS-1, 4-SOIC	B10S-G	Comchip
2	C1	1	33 nF, 400 V, Film	ECQ-E4333KF	Panasonic
3	C3	1	150 nF, 450 V, 10%, Polypropylene Metalized	C222S154K30	Faratronic
4	C5	1	10 μ F, \pm 10%, 16 V, X7R, Ceramic Capacitor, -55°C ~ 125°C, Surface Mount, MLCC 0805 (2012 Metric), 0.079" L x 0.049" W (2.00mm x 1.25mm)	CL21B106KOQNNNG	Samsung
5	C6	1	100 μ F, 63, Electrolytic, Low ESR, 270 m Ω , (8 x 15)	ELXZ630ELL101MH15D	Nippon Chemi-Con
6	C9	1	100 pF, 500 V, Ceramic, NPO, 0805	501R15N101KV4T	Johanson Dielectrics
7	D1	1	Diode Ultrafast, SW 600 V, 1 A, SMA	US1J-13-F	Diodes, Inc.
8	L1	1	3300 μ H, 62 mA, 59.5 Ω , Axial Ferrite Inductor	B78108S1335J	Epcos
9	R3	1	RES, 15.4 k Ω , 1%, 1/16 W, Thick Film, 0603	ERJ-3EKF1542V	Panasonic
10	R4	1	RES, 2.00 Ω , 1%, 1/8 W, Thick Film, 0805	RC0805FR-072RL	Yageo
11	R5	1	RES, 402 k Ω , 1%, 1/4 W, Thick Film, 1206	ERJ-8ENF4023V	Panasonic
12	R6	1	RES, 51 k Ω , 5%, 1/10 W, Thick Film, 0603	ERJ-3GEYJ513V	Panasonic
13	R7	1	RES, 1.91 Ω , 1%, 1/8 W, Thick Film, 0805	RC0805FR-071R91L	Yageo
14	R8	1	RES, 0 R, 5%, 1/4 W, Thick Film, 1206	ERJ-8GEY0R00V	Panasonic
15	RF1	1	RES, 4.7 Ω , 1 W, Fusible/Flame Proof Wire Wound	FKN1WSJR-52-4R7	Yago
16	RV1	1	275 V, 8.6 J, 5 mm, RADIAL	S05K275	Epcos
17	T1	1	Bobbin, EE8.3, Vertical, 6 pins (8.2 mm W x 8.2 mm L x 6.9 mm H)	EE-0802	Zhenhui
18	U1	1	LYTSwitch-1, Wide Range, 4W, 25V-50V, SO-8	LYT1402D	Power Integrations

Miscellaneous

19	WIRE24A WG_INS1	1	Wire, UL1007, #24 AWG, Wht, PVC, 40 mm	1007-24/7-9	Anixter
20	WIRE24A WG_INS2	1	Wire, UL1007, #24 AWG, Red, PVC, 40 mm	1007-24/7-2	Anixter
21	WIRE24A WG_INS3	1	Wire, UL1007, #24 AWG, Blk, PVC, 40 mm	1007-24/7-0	Anixter

7 Inductor Specification

7.1 Electrical Diagram

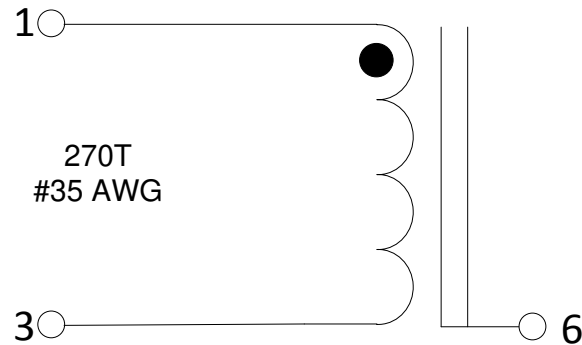

Figure 7 – Inductor Electrical Diagram.

7.2 Electrical Specifications

Parameter	Condition	Spec.
Nominal Primary Inductance	Measured at 1 V _{PK-PK} , 100 kHz switching frequency, between pin 1 and pin 3, with all other windings open.	1500 μ H
Tolerance	Tolerance of Primary Inductance.	\pm 5%

7.3 Material List

Item	Description
[1]	Core: EE8.3 Note: Use EE8.3D P4 Material from ACME for high ambient temperature application.
[2]	Bobbin, EE8.3, Vertical, 6 pins
[3]	Magnet Wire: #35 AWG.
[4]	Transformer Tape: 4.5 mm.
[5]	Tin Wire (Bare).
[6]	Transformer Tape: 3.5 mm.

7.4 Inductor Build Diagram

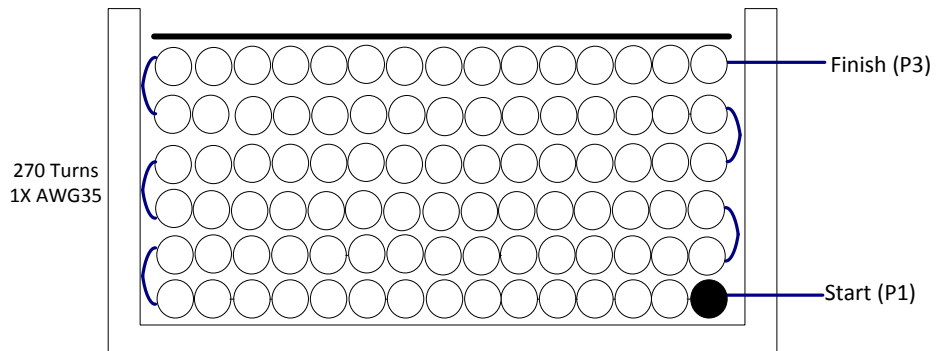
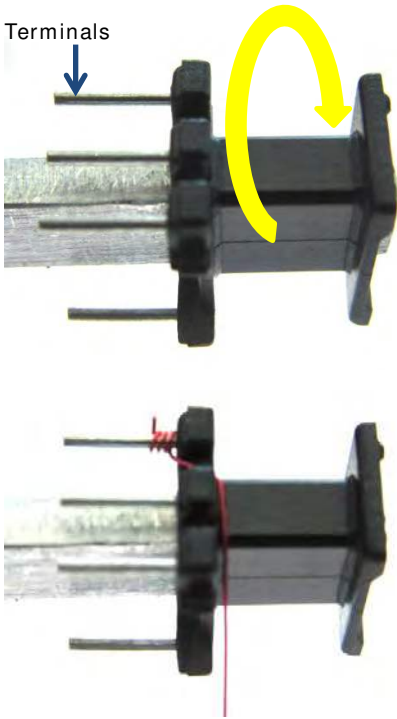
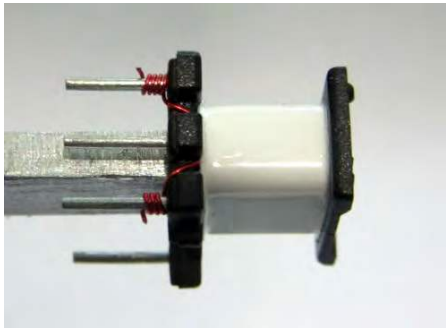

Figure 8 – Transformer Build Diagram.

7.5 Inductor Construction

Winding Directions	Bobbin is oriented on winder jig such that terminal pins are in the right side. The winding direction is clockwise.
Winding 1	Use wire item [3], start at pin 1 and wind 270 turns in 8 layers, then finish the winding on pin 3.
Insulation	Add 2 layers of tape, item [4], for insulation.
Core Grinding	Grind the center leg of one core until it meets the nominal inductance of 1500 μ H.
Assemble Core	Assemble the 2 cores on the bobbin.
Core Wire	Use wire item [5], two turns on the core, terminate on pin 6 and wrap with 2 layers of tape, Item (6).
Pins	Pull out Terminal pin no. 2, 4 and 5
Finish	Dip the transformer assembly in varnish.

7.6 Winding Illustrations

<p>Winding Directions</p> <p>Bobbin is oriented on winder jig such that terminal pin 1-6 is in the Left side. The winding direction is clockwise as shown in the figure.</p> <p>Winding 1</p> <p>Use wire item [3], start at pin 1 and wind 270 turns, then finish the winding on pin 3.</p>	
<p>Insulation</p> <p>Add 2 layers of tape, item [4], for insulation.</p>	

Core Grinding

Grind the center leg of one core until it meets the nominal inductance of 1500 μ H.

Core Assembly

Assemble the 2 cores on the bobbin. Use wire item [5], 2 turns around the cores as shown. Terminate the wire on pin6.

Wrap the 2 cores with polyester tape Item [6]. See figure on the right side.

Finish

Dip the transformer assembly in 2:1 thinner and Varnish solution.

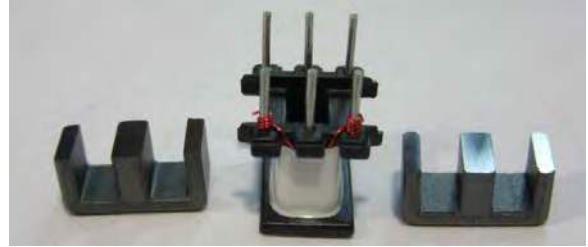

8 Inductor Design Spreadsheet

ACDC_LYTSwitch1_Buck_031816; Rev.0.1; Copyright Power Integrations 2016	INPUT	INFO	OUTPUT	UNIT	LYTSwitch-1 Buck Design Spreadsheet
ENTER APPLICATION VARIABLES					
LINE VOLTAGE RANGE			Universal		AC line voltage range
VACMIN	90.00		90.00	Volts AC	Minimum AC line voltage
VACTYP	230.00		230.00	Volts AC	Typical AC line voltage
VACMAX	300.00		300.00	Volts AC	Maximum AC line voltage
fL	50.00		50.00	Hz	AC mains frequency
VO	48.00		48.00	Volts DC	Worst case normal operating output voltage
IO	0.095		0.095	Amperes	Average output current specification
EFFICIENCY	0.87		0.87		Efficiency estimate
PO			4.56	Watts	Continuous output power
VD			0.70	Volts DC	Output diode forward voltage drop
OPTIMIZATION PARAMETER	BOM		BOM		Parameter to be optimized
ENTER LYTSWITCH-1 VARIABLES					
DEVICE BREAKDOWN VOLTAGE	725		725	Volts DC	Choose between 650V and 725V
GENERIC DEVICE	Auto		LYT1XX2D		Generic LYTSwitch-1 device based on power
DEVICE CODE			LYT1402D		Actual LYTSwitch-1 device code
ILIMITMIN			0.59	Amperes	Minimum Current Limit
ILIMITTYP			0.64	Amperes	Typical Current Limit
ILIMITMAX			0.68	Amperes	Maximum Current Limit
TON			1.83	us	On-time during the fixed on-time region at VACTYP
FSW			95.71	kHz	Maximum switching frequency in the fixed current limit region at VACTYP
DMAX			0.52		Maximum duty cycle possible in the fixed on-time region
ENTER INDUCTOR CORE/ CONSTRUCTION VARIABLES					
CORE	EE8.3		EE8.3		Enter Transformer Core
CUSTOM CORE NAME					If custom core is used - Enter part number here
AE			7.00	mm ²	Core effective cross sectional area
LE			19.20	mm	Core effective path length
AL			610.00	nH/turn ²	Core ungapped effective inductance
AW			14.00	mm ²	Window Area of the bobbin
BW			4.80	mm	Bobbin physical winding width
MARGIN			0.00	mm	Safety Margin Width (Half the Primary to Secondary Creepage Distance)
LAYERS			8		Number of Layers
INDUCTOR DESIGN PARAMETERS					
LP_MIN_ABSOLUTE			1294	uH	Absolute minimum design inductance
LP_TYP	1500		1500	uH	Typical design inductance
LP_TOLERANCE	5		5	%	Tolerance of the design inductance
LP_MAX			2195	uH	Absolute maximum design inductance
URNS	270		270	Turns	Number of inductor turns
ALG			20.58	nH/turn ²	Inductance per turns squared
BMAX			3700	Gauss	Operating maximum flux density in the fixed peak current region
BMAX_ACTUAL			2850	Gauss	Actual saturation flux density in the fixed peak current region
BAC			1850	Gauss	AC flux density in the fixed peak current region
LG			0.413	mm	Core air gap
BWE			38.40	mm	Effective bobbin width
OD			0.142	mm	Outer diameter of the wire with insulation
INS			0.033	mm	Wire insulation
DIA			0.109	mm	Outer diameter of the wire without insulation
AWG			35		AWG of the bare wire.



CM			32	Cmils	Bare wire circular mils
CMA			256.6	Cmils/A	Bare wire circular mils per ampere
CURRENT DENSITY			7.8	A/mm ²	Bare wire current density
BOBBIN FILL FACTOR			39.01%		Decrease the number of layers to ensure that the wire fits in the bobbin.
CURRENT WAVEFORM SHAPE PARAMETERS					
I AVERAGE_INDUCTOR			0.093	Amperes	Average inductor current at VACTYP obtained from half-line cycle emulation
I PEAK_MOSFET			0.285	Amperes	MOSFET peak current at VACTYP when operating in the current limit region
I RMS_MOSFET			0.053	Amperes	MOSFET RMS current at VACTYP obtained from half-line cycle emulation
I RMS_DIODE			0.113	Amperes	Diode RMS current at VACTYP obtained from half-line cycle emulation
I RMS_INDUCTOR			0.125	Amperes	Inductor RMS current at VACTYP obtained from half-line cycle emulation
LYT SWITCH EXTERNAL COMPONENTS					
FB Pin Resistor					
RFB (Non standard value)			1.053	Ohms	Non standard value of the feedback pin sense resistor
RFB (Standard 1% Value)			1.050	Ohms	Standard 1% value of the feedback pin sense resistor
M Pin Resistor					
R UPPER (Standard 1% Value)			400.00	kOhms	Standard 1% value of the upper (fixed) resistor on the M-pin divider network
R LOWER (Non standard value)			17.39	kOhms	Non standard value of the lower resistor on the M-pin divider network
R LOWER (Standard 1% Value)	15.40		15.40	kOhms	Standard 1% value of the lower resistor on the M-pin divider network
LOAD OVERVOLTAGE THRESHOLD			64.738	Volts DC	Load overvoltage threshold
LINE OVERVOLTAGE THRESHOLD			448.00	Volts DC	Line overvoltage threshold
VOLTAGE STRESS PARAMETERS					
VDRAIN			424.26	Volts DC	Estimated worst case drain voltage
PIVD			424.26	Volts DC	Output Rectifier Maximum Peak Inverse Voltage

9 Performance Data

All measurements were performed at room temperature using LED load string. 1 minute soak time was applied before measurement with AC source turned-off for 5 seconds every succeeding input line measurement.

9.1 Efficiency

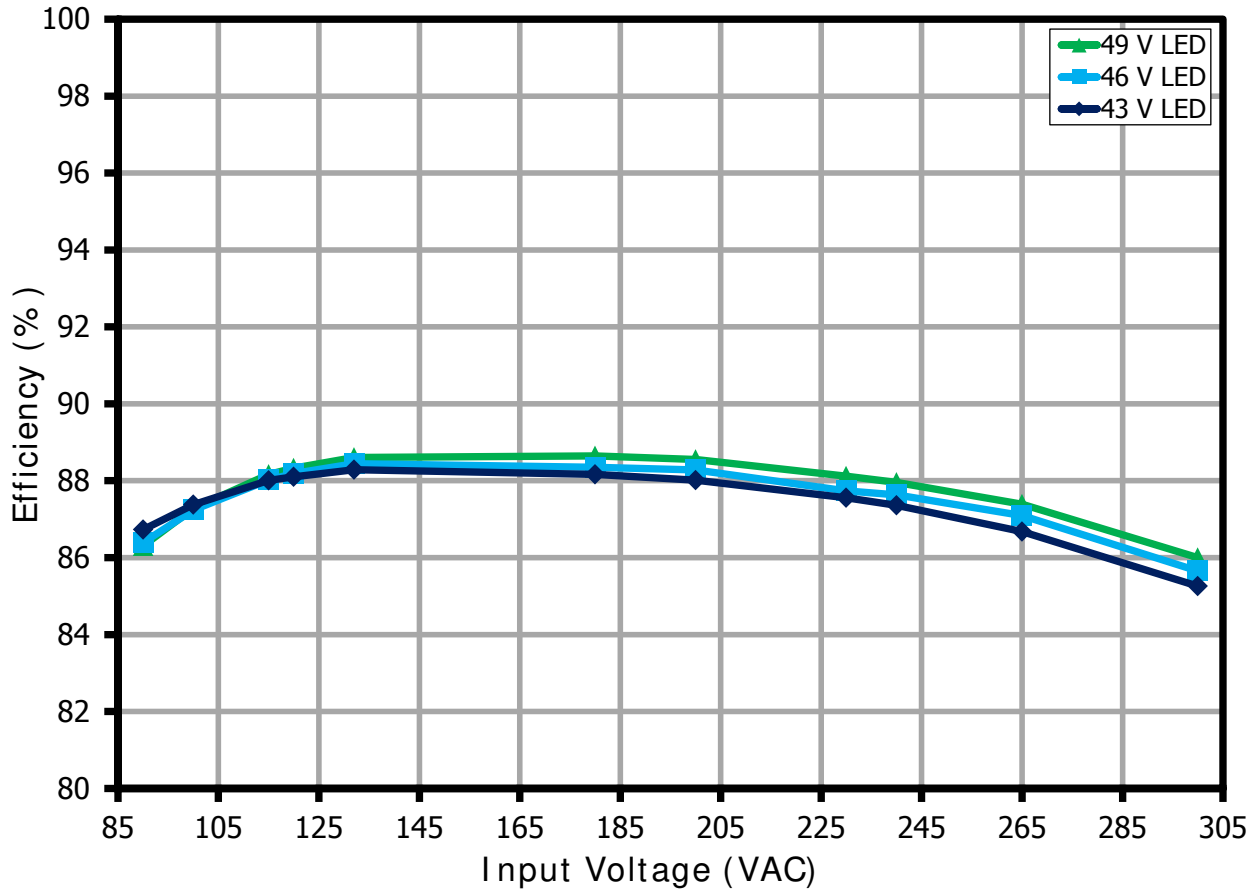

Figure 9 – Efficiency vs. Line and LED Load.

9.2 Line Regulation

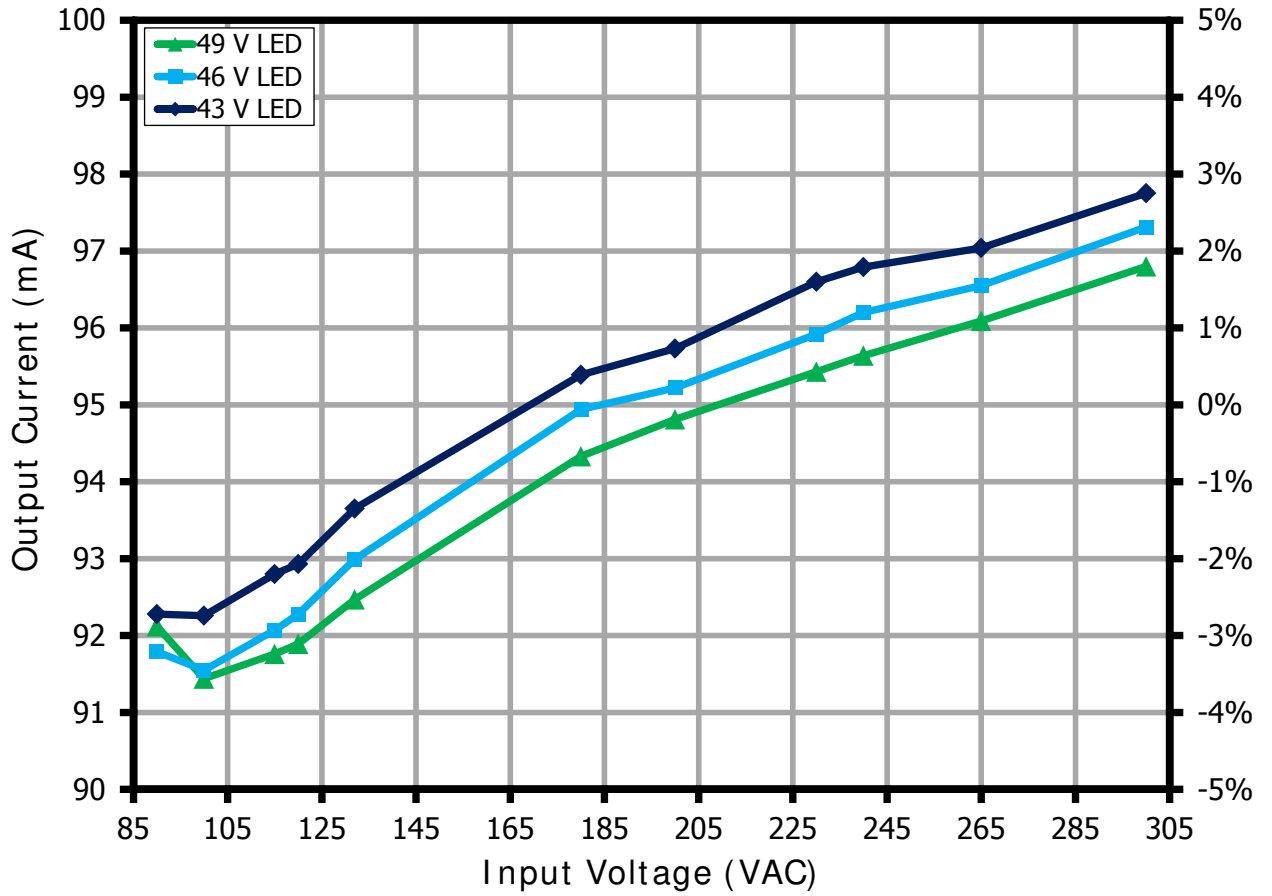

Figure 10 – Regulation vs. Line and LED Load.



9.3 Power Factor

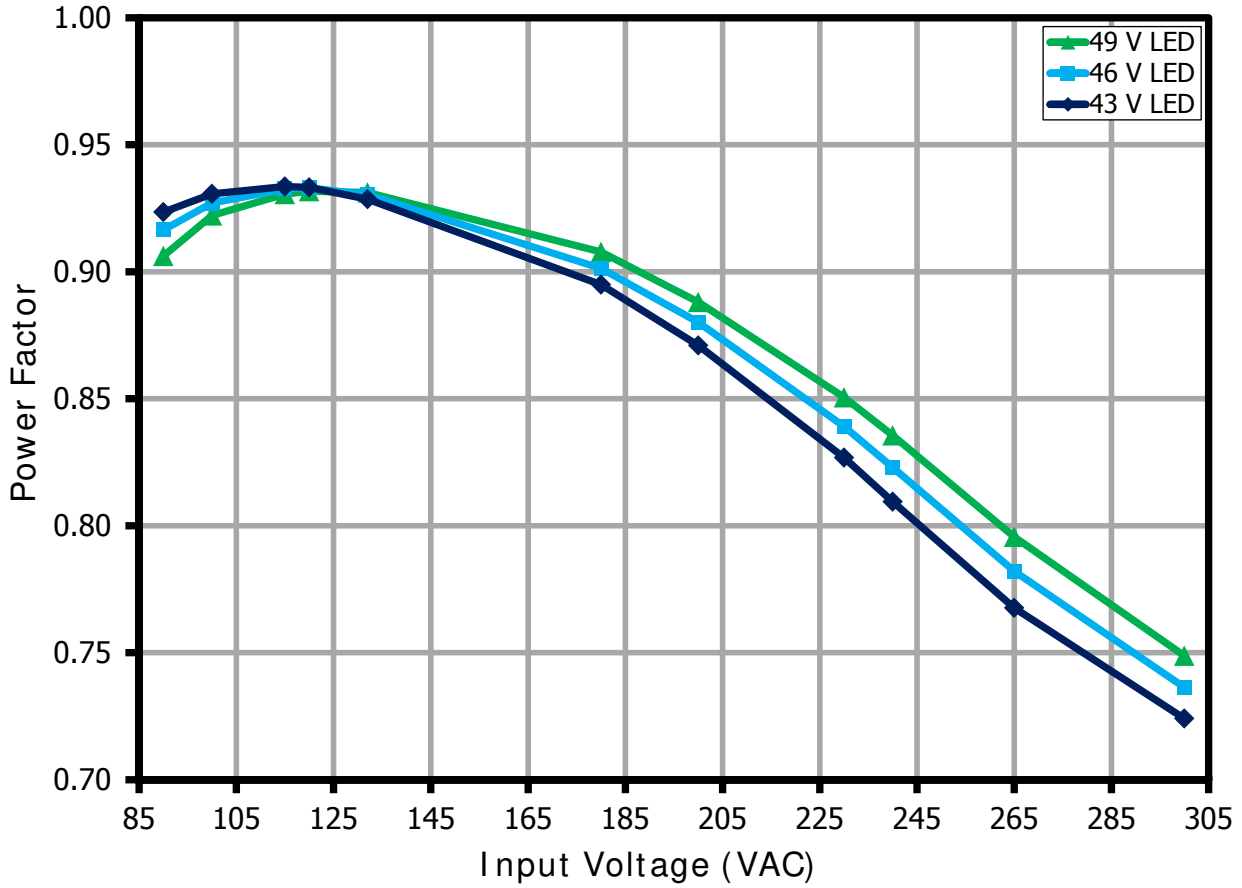

Figure 11 – Power Factor vs. Line and LED Load.

9.4 %ATHD

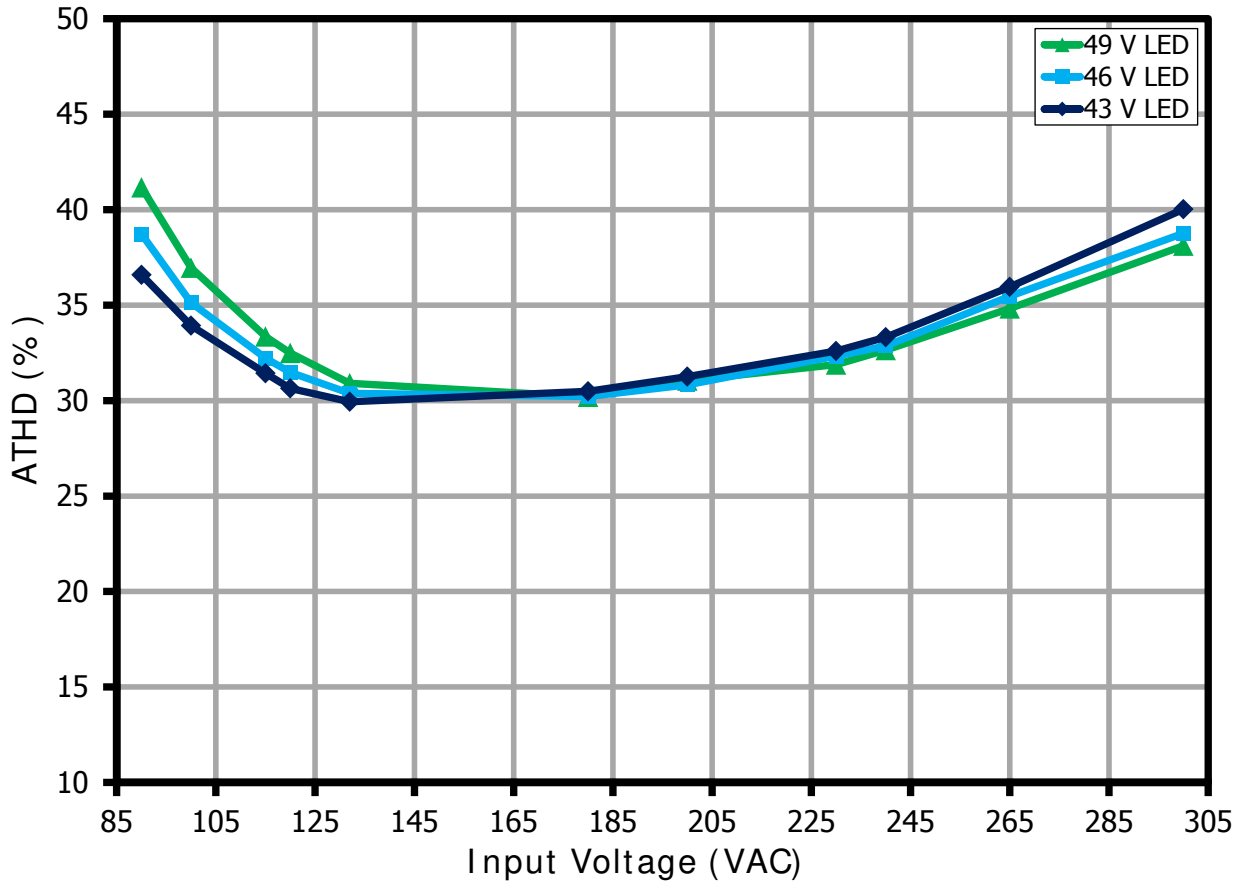

Figure 12 – %ATHD vs. Line and LED Load.



9.5 Individual Harmonics Content

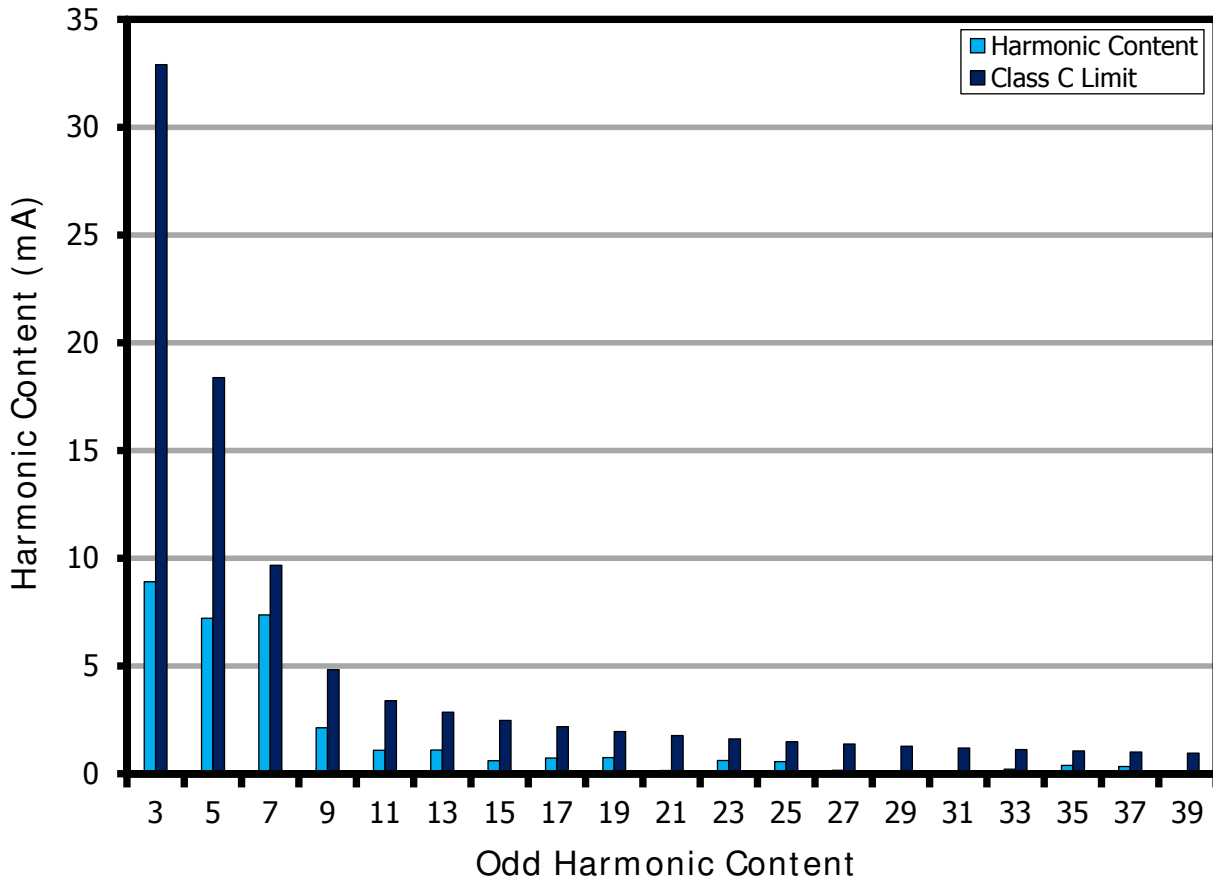

Figure 13 – 48 V LED Load Input Current Harmonics at 115 VAC, 60 Hz.

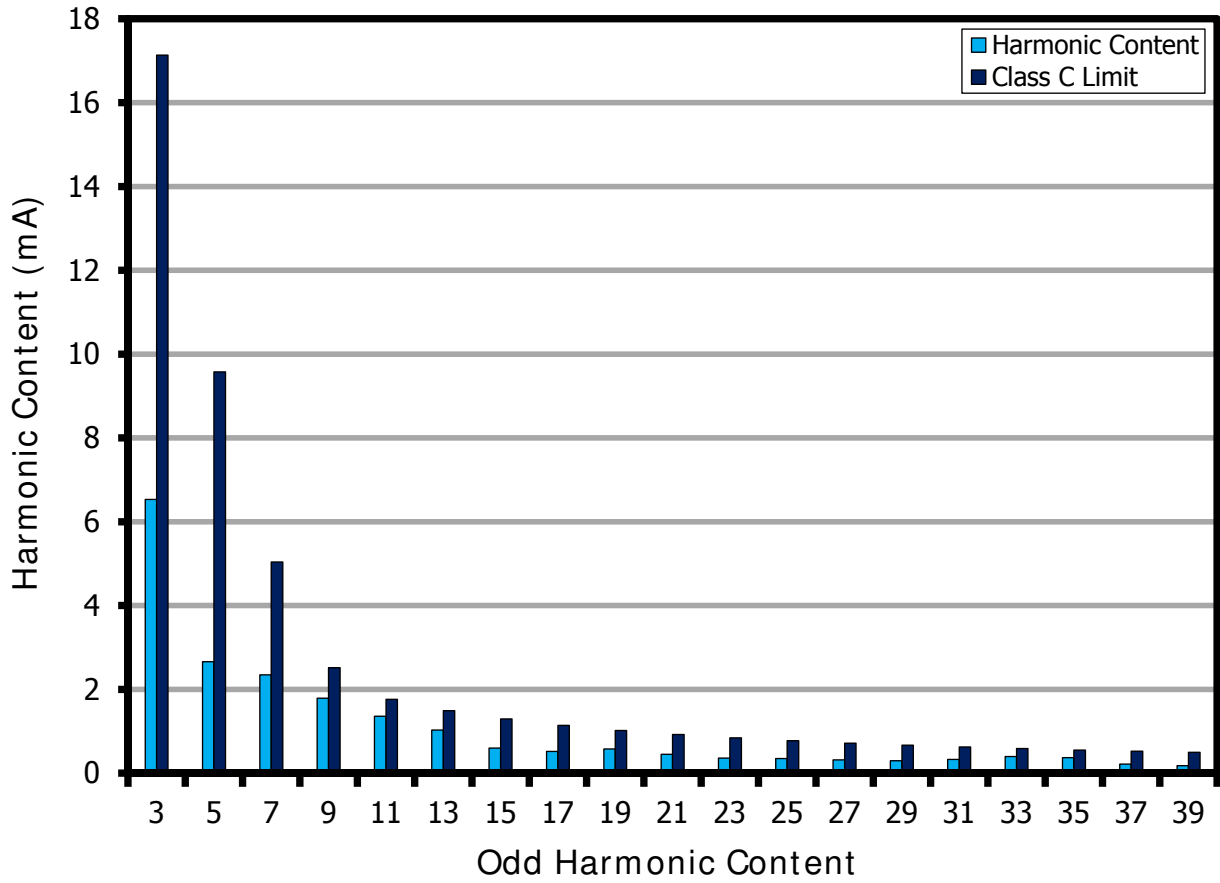

Figure 14 – 48 V LED Load Input Current Harmonics at 230 VAC, 50 Hz.



10 Test Data

10.1 Test Data, 43 V LED Load

Input		Input Measurement					LED Load Measurement			Efficiency (%)
VAC (V _{RMS})	Freq (Hz)	V _{IN} (V _{RMS})	I _{IN} (mA _{RMS})	P _{IN} (W)	PF	% ATHD	V _{OUT} (V _{DC})	I _{OUT} (mA _{DC})	P _{OUT} (W)	
90	60	90.00	56.20	4.67	0.924	36.58	43.79	92.28	4.05	86.73
100	60	99.94	49.69	4.62	0.931	33.92	43.67	92.26	4.04	87.38
115	60	115.01	42.95	4.61	0.934	31.43	43.63	92.80	4.06	88.01
120	60	119.98	41.17	4.61	0.933	30.64	43.60	92.93	4.06	88.10
132	60	131.95	37.84	4.64	0.929	29.93	43.60	93.65	4.09	88.29
180	50	179.97	29.40	4.74	0.895	30.49	43.64	95.39	4.18	88.17
200	50	200.00	27.32	4.76	0.871	31.25	43.64	95.73	4.19	88.01
230	50	229.96	25.41	4.83	0.827	32.59	43.66	96.60	4.23	87.56
240	50	239.98	24.98	4.85	0.810	33.31	43.66	96.79	4.24	87.36
265	50	265.00	24.06	4.90	0.768	35.96	43.66	97.04	4.25	86.68
300	50	300.02	23.09	5.02	0.724	40.03	43.68	97.75	4.28	85.26

10.2 Test Data, 46 V LED Load

Input		Input Measurement					LED Load Measurement			Efficiency (%)
VAC (V _{RMS})	Freq (Hz)	V _{IN} (V _{RMS})	I _{IN} (mA _{RMS})	P _{IN} (W)	PF	% ATHD	V _{OUT} (V _{DC})	I _{OUT} (mA _{DC})	P _{OUT} (W)	
90	60	90.01	60.14	4.96	0.917	38.72	46.60	91.79	4.29	86.40
100	60	99.94	52.78	4.89	0.927	35.13	46.50	91.55	4.27	87.24
115	60	115.01	45.43	4.87	0.933	32.22	46.48	92.07	4.29	88.02
120	60	119.98	43.51	4.87	0.933	31.48	46.45	92.28	4.30	88.19
132	60	131.95	39.88	4.90	0.930	30.38	46.46	92.99	4.33	88.44
180	50	179.98	30.90	5.01	0.901	30.22	46.52	94.94	4.43	88.35
200	50	200.01	28.58	5.03	0.880	30.83	46.52	95.22	4.44	88.28
230	50	229.97	26.40	5.10	0.839	32.33	46.53	95.92	4.48	87.74
240	50	239.99	25.93	5.12	0.823	32.86	46.53	96.20	4.49	87.63
265	50	265.00	24.94	5.17	0.782	35.46	46.53	96.55	4.50	87.09
300	50	300.03	23.99	5.30	0.736	38.76	46.55	97.31	4.54	85.65

10.3 Test Data, 49 V LED Load

Input		Input Measurement					LED Load Measurement			Efficiency (%)
VAC (V _{RMS})	Freq (Hz)	V _{IN} (V _{RMS})	I _{IN} (mA _{RMS})	P _{IN} (W)	PF	% ATHD	V _{OUT} (V _{DC})	I _{OUT} (mA _{DC})	P _{OUT} (W)	
90	60	90.00	65.27	5.32	0.906	41.17	49.78	92.12	4.60	86.31
100	60	99.94	56.47	5.21	0.922	36.96	49.59	91.44	4.54	87.28
115	60	115.01	48.25	5.16	0.931	33.36	49.52	91.76	4.55	88.16
120	60	119.98	46.13	5.16	0.932	32.50	49.47	91.89	4.55	88.32
132	60	131.95	42.08	5.17	0.931	30.91	49.45	92.47	4.58	88.61
180	50	179.97	32.32	5.28	0.908	30.20	49.49	94.33	4.68	88.64
200	50	200.01	29.90	5.31	0.888	31.05	49.48	94.81	4.70	88.55
230	50	229.96	27.46	5.37	0.851	31.88	49.47	95.43	4.73	88.12
240	50	239.99	26.90	5.39	0.836	32.64	49.46	95.64	4.74	87.96
265	50	265.00	25.85	5.45	0.796	34.83	49.46	96.09	4.76	87.39
300	50	300.02	24.84	5.58	0.749	38.11	49.47	96.80	4.80	86.00

10.4 *Test Data, Harmonic Content at 115 VAC, 48 V LED Load*

V_{IN} (V_{RMS})	Freq	I_{IN} (mA_{RMS})	P_{IN} (W)	% THD
115	60	45.43	4.872	32.22%
nth Order	mA Content	% Content	mA Limit < 25 W	Remarks
1	42.30			
2	0.06	0.14%		
3	8.91	21.06%	32.90	Pass
5	7.22	17.07%	18.38	Pass
7	7.37	17.42%	9.68	Pass
9	2.14	5.06%	4.84	Pass
11	1.09	2.58%	3.39	Pass
13	1.10	2.60%	2.87	Pass
15	0.61	1.44%	2.48	Pass
17	0.73	1.73%	2.19	Pass
19	0.75	1.77%	1.96	Pass
21	0.15	0.35%	1.77	Pass
23	0.62	1.47%	1.62	Pass
25	0.57	1.35%	1.49	Pass
27	0.16	0.38%	1.38	Pass
29	0.07	0.17%	1.28	Pass
31	0.07	0.17%	1.20	Pass
33	0.22	0.52%	1.13	Pass
35	0.39	0.92%	1.06	Pass
37	0.34	0.80%	1.01	Pass
39	0.08	0.19%	0.96	Pass

10.5 *Test Data, Harmonic Content at 230 VAC, 48 V LED Load*

V_{IN} (V_{RMS})	Freq	I_{IN} (mA_{RMS})	P_{IN} (W)	% THD
230	50	26.4	5.100	32.33%
nth Order	mA Content	% Content	mA Limit < 25 W	Remarks
1	24.03			
2	0.02	0.08%		
3	6.53	27.17%	17.14	Pass
5	2.66	11.07%	9.58	Pass
7	2.35	9.78%	5.04	Pass
9	1.79	7.45%	2.52	Pass
11	1.36	5.66%	1.76	Pass
13	1.03	4.29%	1.49	Pass
15	0.60	2.50%	1.29	Pass
17	0.52	2.16%	1.14	Pass
19	0.58	2.41%	1.02	Pass
21	0.45	1.87%	0.92	Pass
23	0.36	1.50%	0.84	Pass
25	0.35	1.46%	0.78	Pass
27	0.32	1.33%	0.72	Pass
29	0.30	1.25%	0.67	Pass
31	0.33	1.37%	0.63	Pass
33	0.40	1.66%	0.59	Pass
35	0.37	1.54%	0.55	Pass
37	0.22	0.92%	0.52	Pass
39	0.18	0.75%	0.50	Pass

11 Thermal Performance

11.1 Thermal Performance Scan – Open Frame Unit

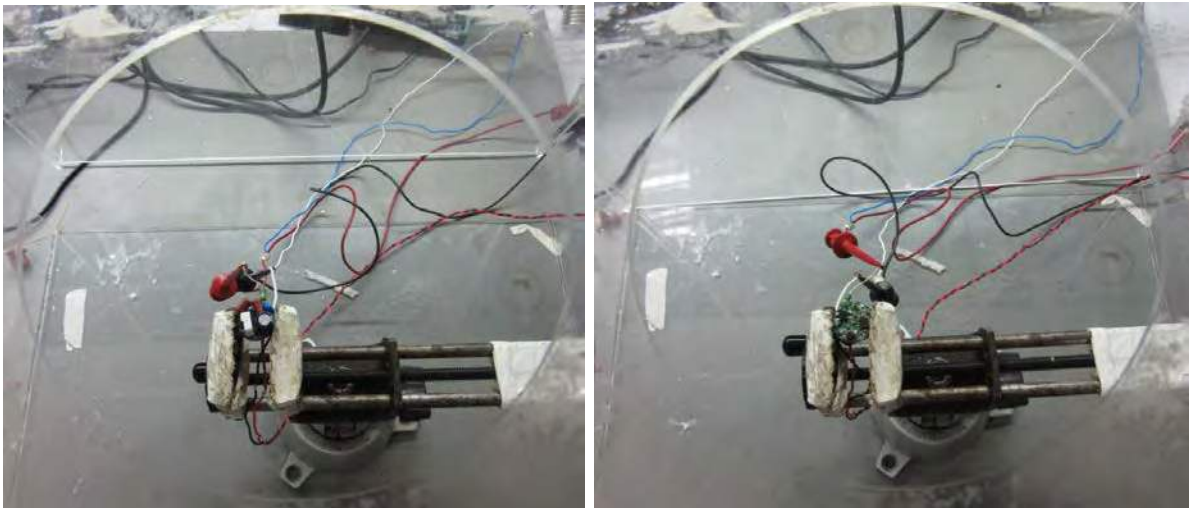

Figure 15 – Test Set-up Picture - Open Frame.

Unit in open frame was placed inside the acrylic enclosure to prevent airflow that might affect the thermal measurements. Temperature was measured using FLIR thermal camera. The ambient temperature is 25 °C.

11.1.1 Thermal Scan at Normal Operation 90 VAC, 48 V LED Load

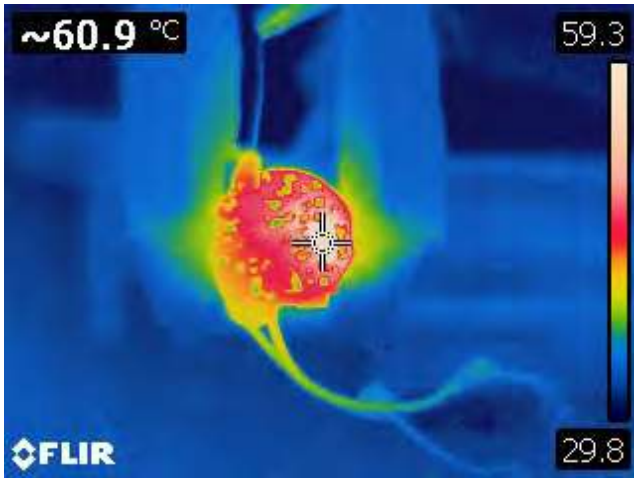

Figure 16 – 90 VAC, 48 V LED Load.
Spot 1: LYT1402D (U1): 60.9 °C.

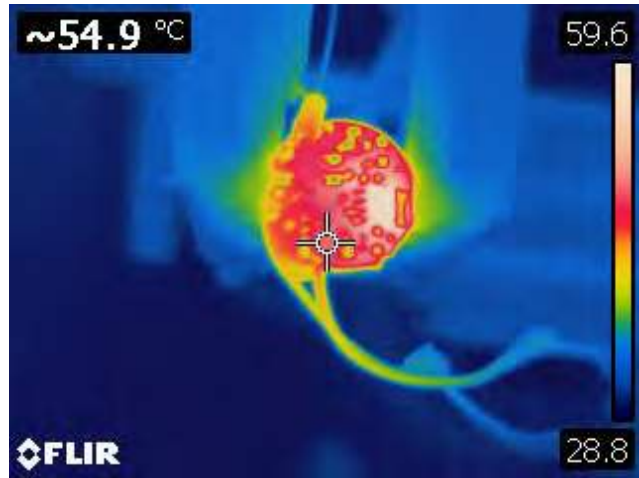

Figure 17 – 90 VAC, 48 V LED Load.
Spot 1: Flywheel Diode (D1): 54.9 °C.

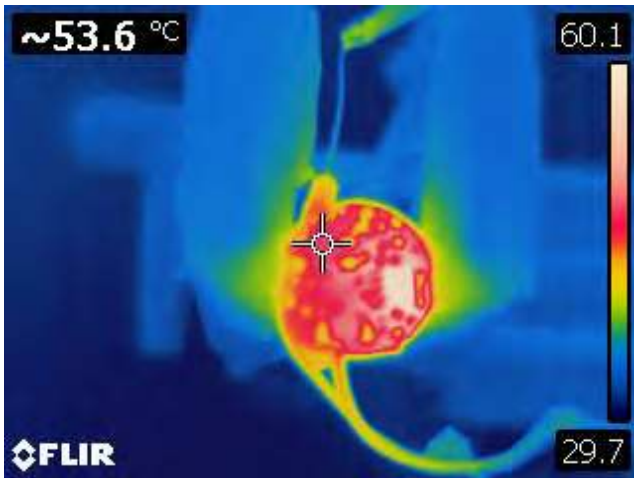

Figure 18 – 90 VAC, 48 V LED Load.
Spot 1: Bridge Diode (BR1): 53.6 °C.

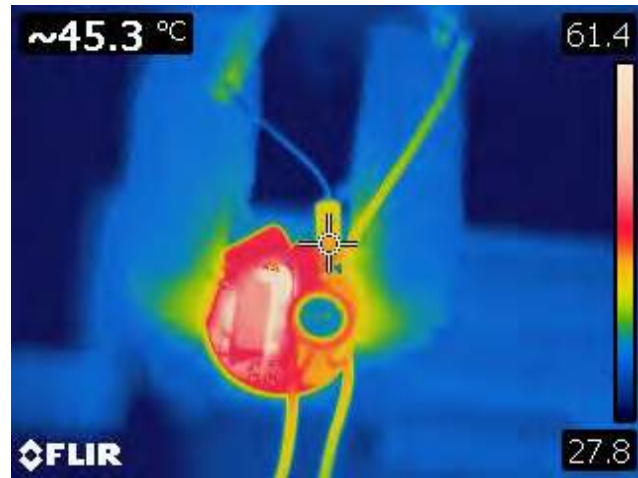

Figure 19 – 90 VAC, 48 V LED Load.
Spot 1: Fusible Resistor (RF1): 45.3 °C.

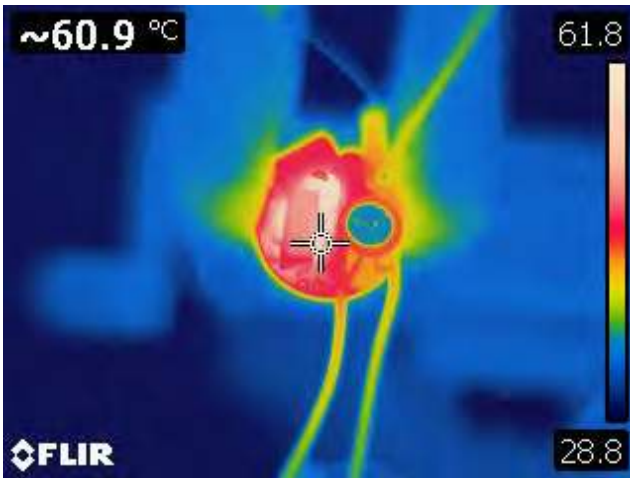

Figure 20 – 90 VAC, 48 V LED Load.
Spot 1: Inductor (T1): 60.9 °C.

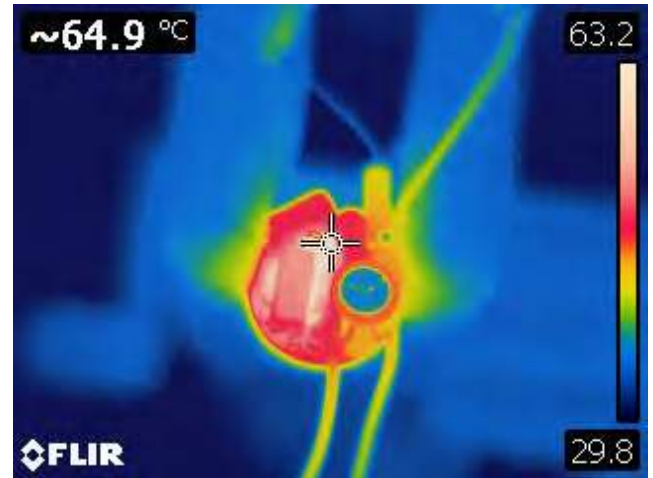

Figure 21 – 90 VAC, 48 V LED Load.
Spot 1: EMI Inductor (L1): 64.9 °C.

11.1.2 Thermal Scan at Normal Operation 115 VAC, 48 V LED Load

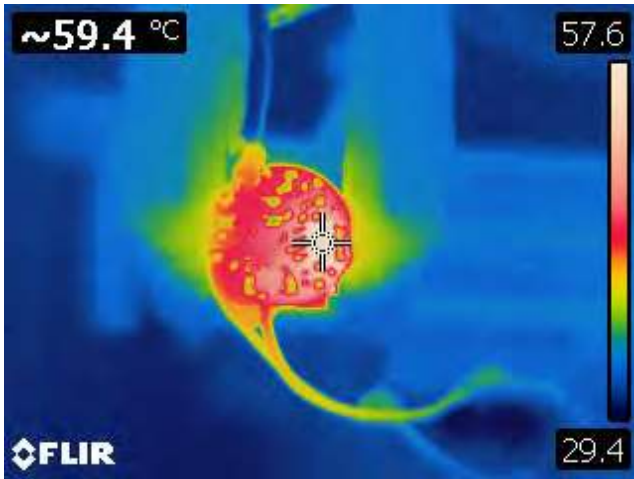

Figure 22 – 115 VAC, 48 V LED Load.
Spot 1: LYT1402D (U1): 59.4 °C.

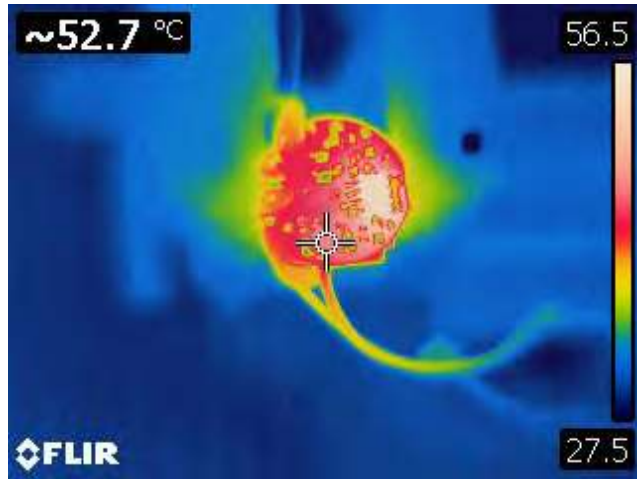

Figure 23 – 115 VAC, 48 V LED Load.
Spot 1: Flywheel Diode (D1): 52.7 °C.

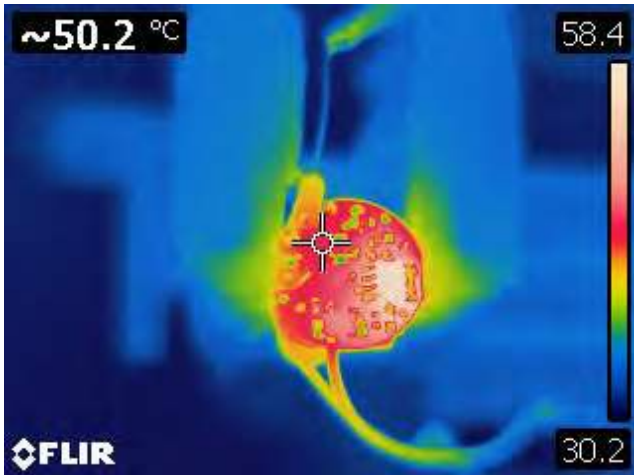

Figure 24 – 115 VAC, 48 V LED Load.
Spot 1: Bridge Diode (BR1): 50.2 °C.

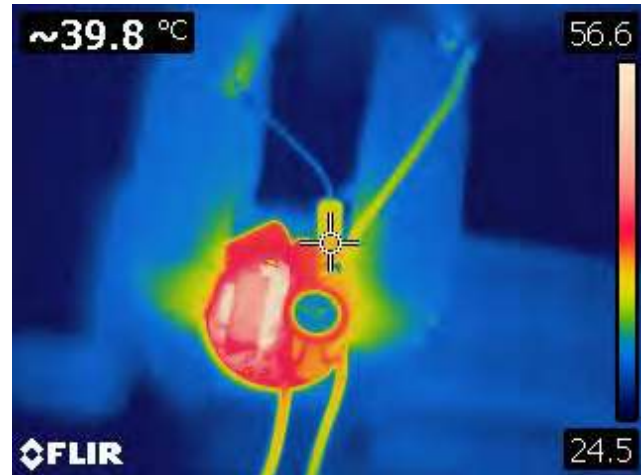

Figure 25 – 115 VAC, 48 V LED Load.
Spot 1: Fusible Resistor (RF1): 39.8 °C.

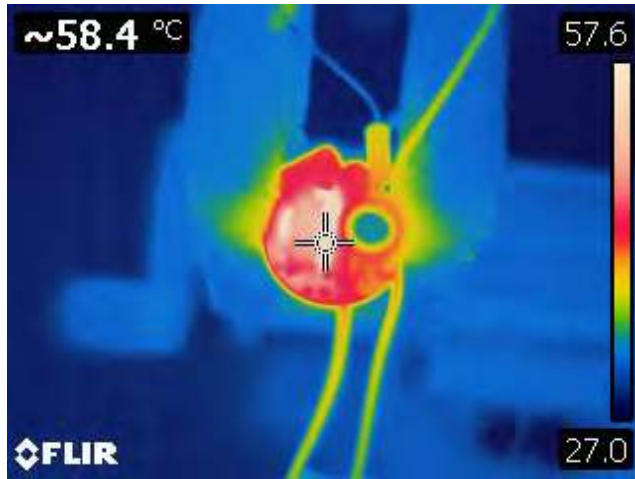

Figure 26 – 115 VAC, 48 V LED Load.
Spot 1: Inductor (T1): 58.4 °C.

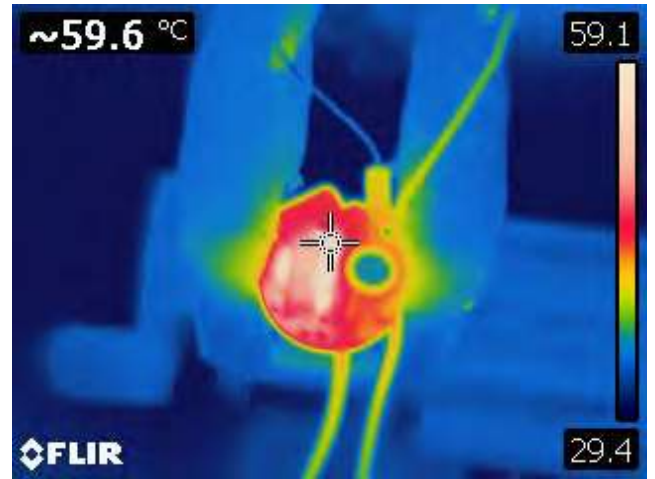

Figure 27 – 115 VAC, 48 V LED Load.
Spot 1: EMI Inductor (L1): 59.6 °C.

11.1.3 Thermal Scan at Normal Operation 230 VAC, 48 V LED Load

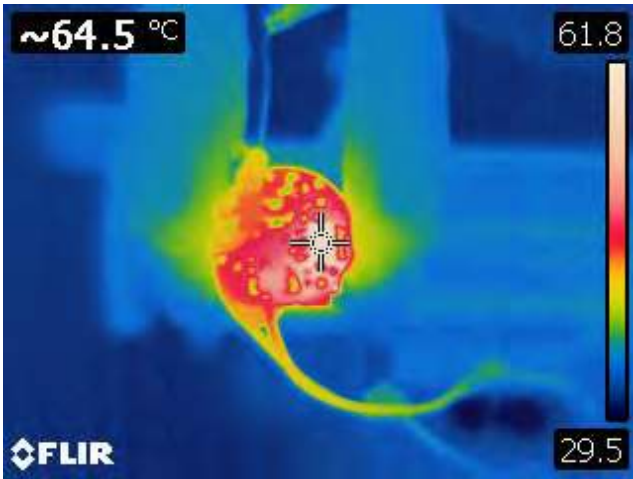

Figure 28 – 230 VAC, 48 V LED Load.
Spot 1: LYT1402D (U1): 64.5 °C.

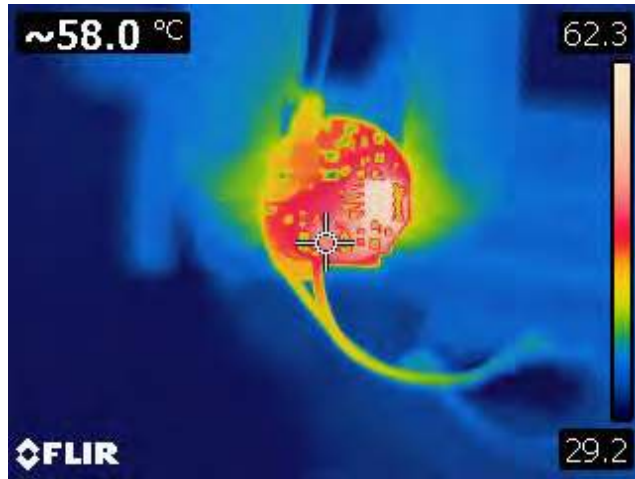

Figure 29 – 230 VAC, 48 V LED Load.
Spot 1: Flywheel Diode (D1): 58 °C.

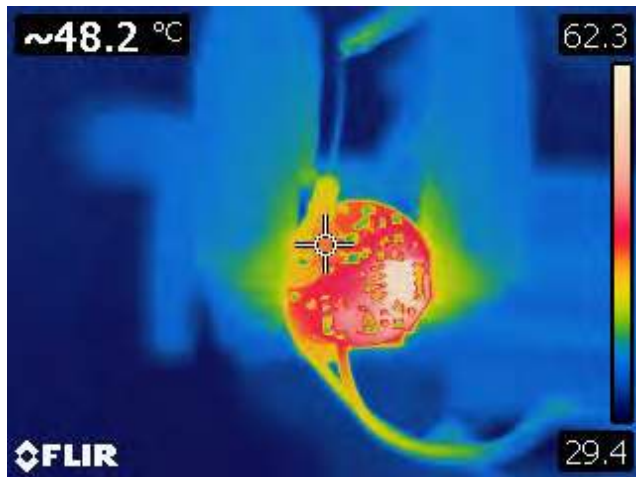

Figure 30 – 230 VAC, 48 V LED Load.
Spot 1: Bridge Diode (BR1): 48.2 °C.

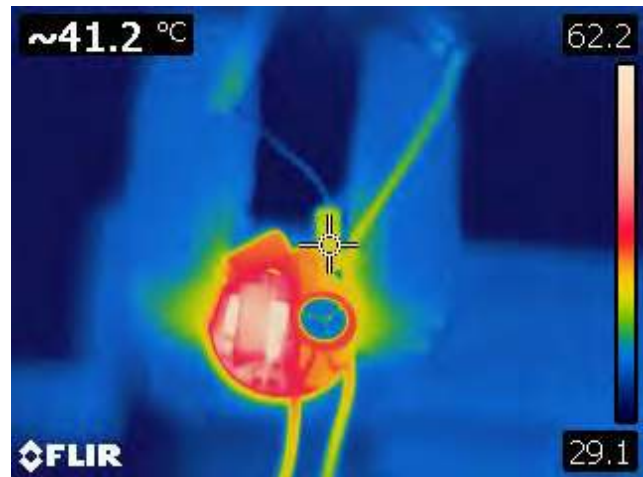

Figure 31 – 230 VAC, 48 V LED Load.
Spot 1: Fusible Resistor (RF1): 41.2 °C.

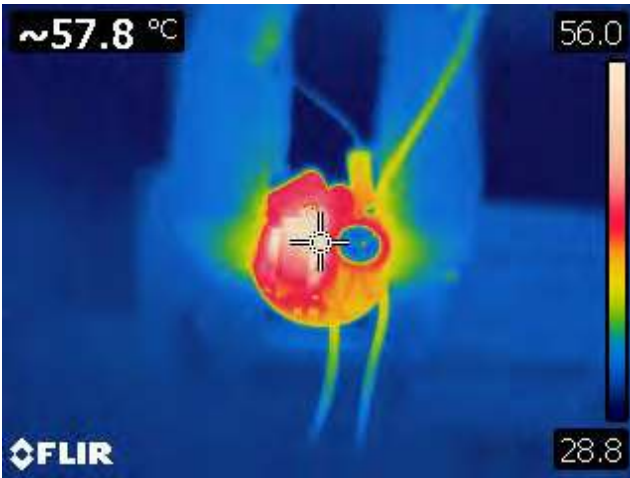

Figure 32 – 230 VAC, 48 V LED Load.
Spot 1: Inductor (T1): 57.8 °C.

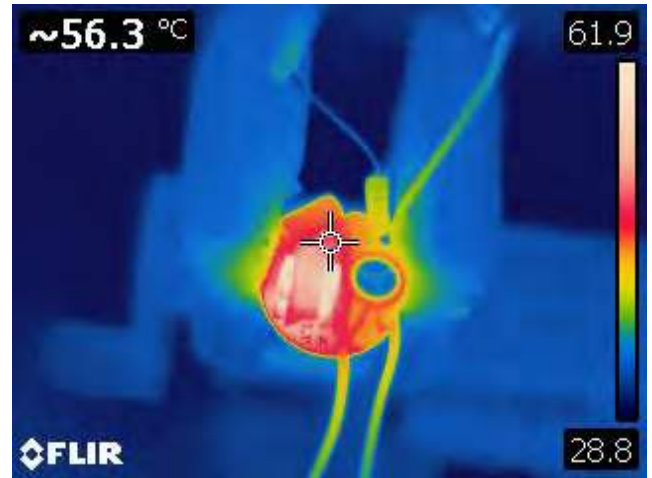

Figure 33 – 230 VAC, 48 V LED Load.
Spot 1: EMI Inductor (L1): 56.3 °C.

11.1.4 Thermal Scan at Normal Operation 300 VAC, 48 V LED Load

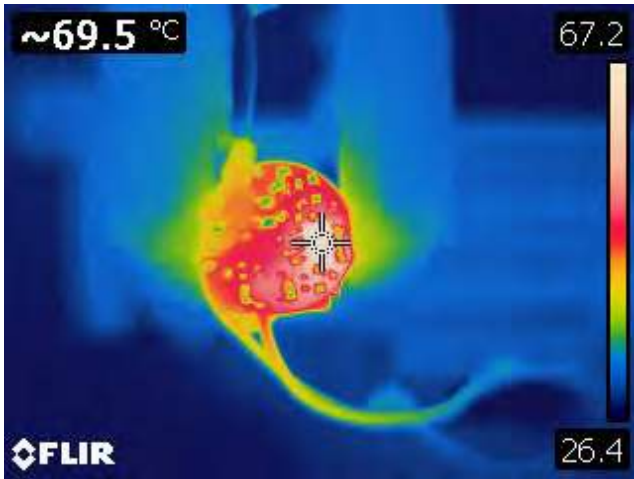

Figure 34 – 300 VAC, 48 V LED Load.
Spot 1: LYT1402D (U1): 69.5 °C.



Figure 35 – 300 VAC, 48 V LED Load.
Spot 1: Flywheel Diode (D1): 62.7 °C.

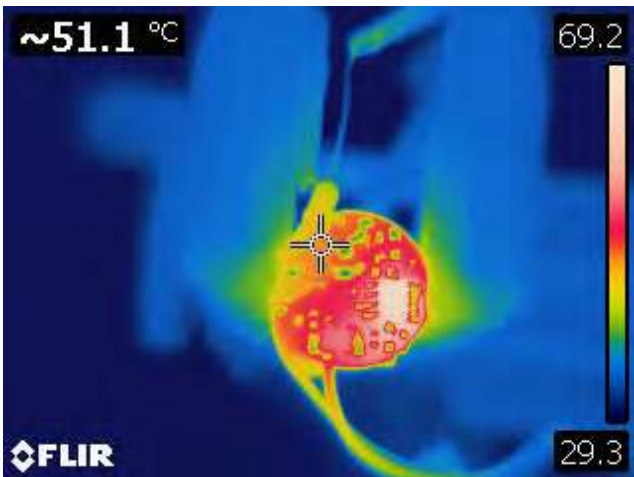

Figure 36 – 300 VAC, 48 V LED Load.
Spot 1: Bridge Diode (BR1): 51.1 °C.



Figure 37 – 300 VAC, 48 V LED Load.
Spot 1: Fusible Resistor (RF1): 41.9 °C.

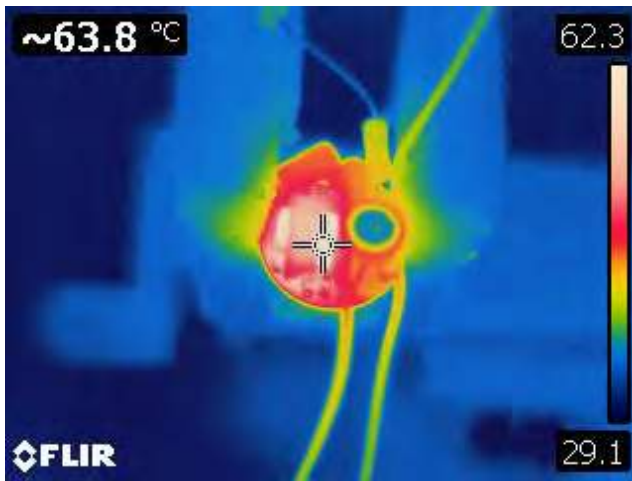

Figure 38 – 300 VAC, 48 V LED Load.
Spot 1: Inductor (T1): 63.8 °C.



Figure 39 – 300 VAC, 48 V LED Load.
Spot 1: EMI Inductor (L1): 60.1 °C.

11.1.5 Thermal Scan During Output Short-Circuit at 115 VAC Input

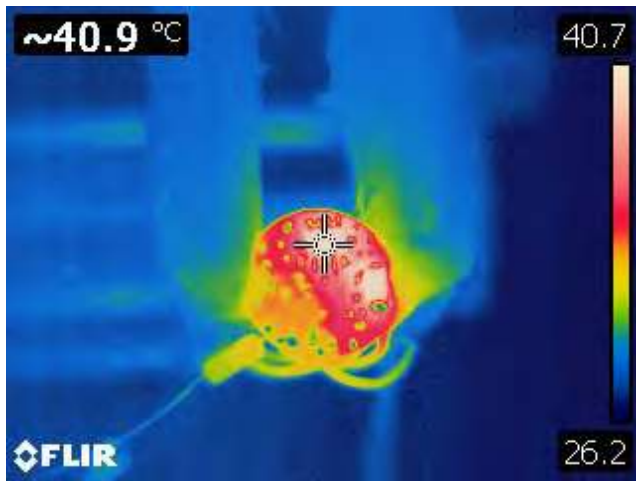

Figure 40 – 115 VAC, Output Short.
Spot 1: LYT1402 (U1): 40.9 °C.



Figure 41 – 115 VAC, 67 V LED Load.
Spot 1: Inductor (T1): 74.2 °C.

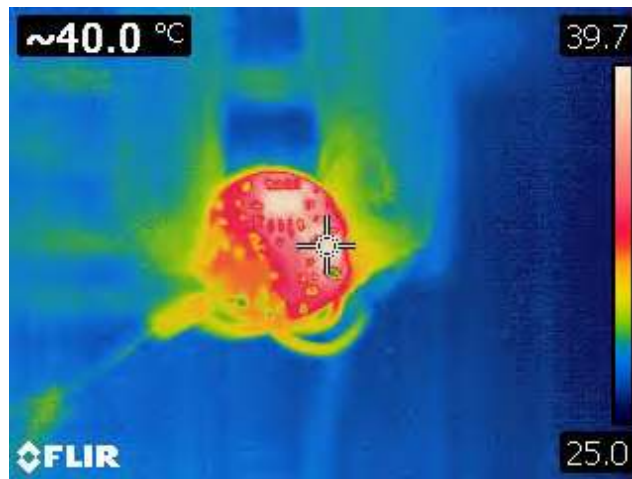

Figure 42 – 115 VAC, Output Short.
Spot 1: Flywheel Diode (D1): 40 °C.

11.1.6 Thermal Scan During Output Short-Circuit at 230 VAC Input

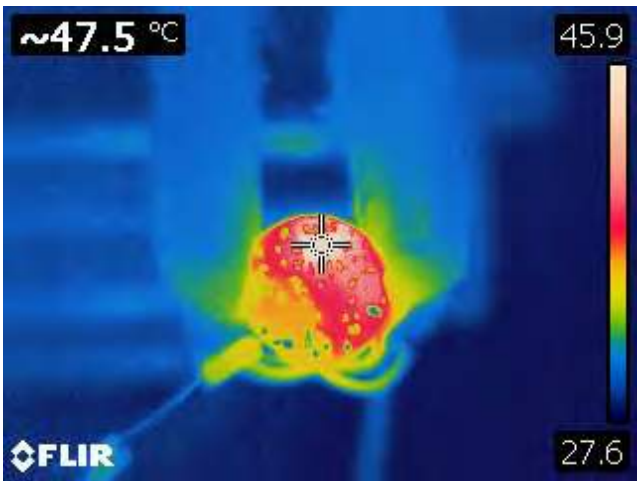

Figure 43 – 230 VAC, Output Short.
Spot 1: LYT1402 (U1): 47.5 °C.

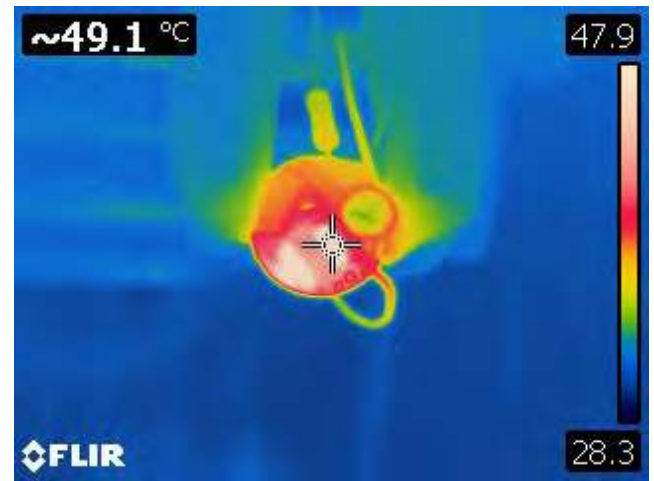

Figure 44 – 230 VAC, Output Short.
Spot 1: Inductor (T1): 49.1 °C.



Figure 45 – 230 VAC, Output Short.
Spot 1: Flywheel Diode (D1): 44.7 °C.

11.2 Thermal Performance at 85 °C Ambient

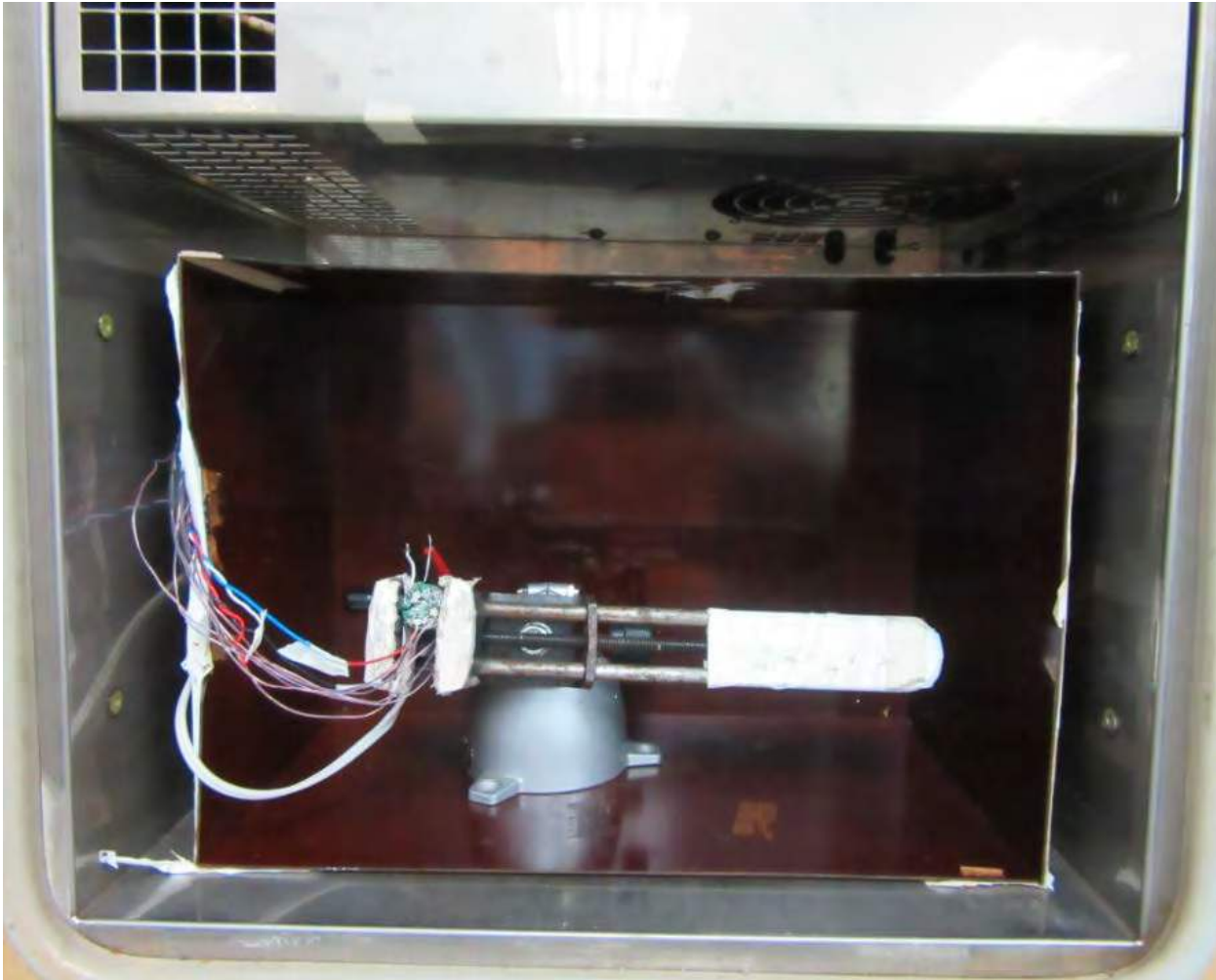

Figure 46 – Test Set-up Picture Thermal at 85 °C Ambient - Open Frame.

Unit in open frame was placed inside the enclosure to prevent airflow that might affect the thermal measurements. Ambient temperature inside enclosure is 85 °C. Temperature was measured using type T thermocouple.

11.2.1 Thermal Performance at 90 VAC with a 48 V LED Load

Measurement	Ambient	LYTSwitch-1	BR1	D1	L1	T1	RF1
Maximum (°C)	85.5	115.3	96.5	106.8	122.5	117.2	105.5
Final (°C)	85.5	115.3	96.5	106.8	122.5	117.2	105.5

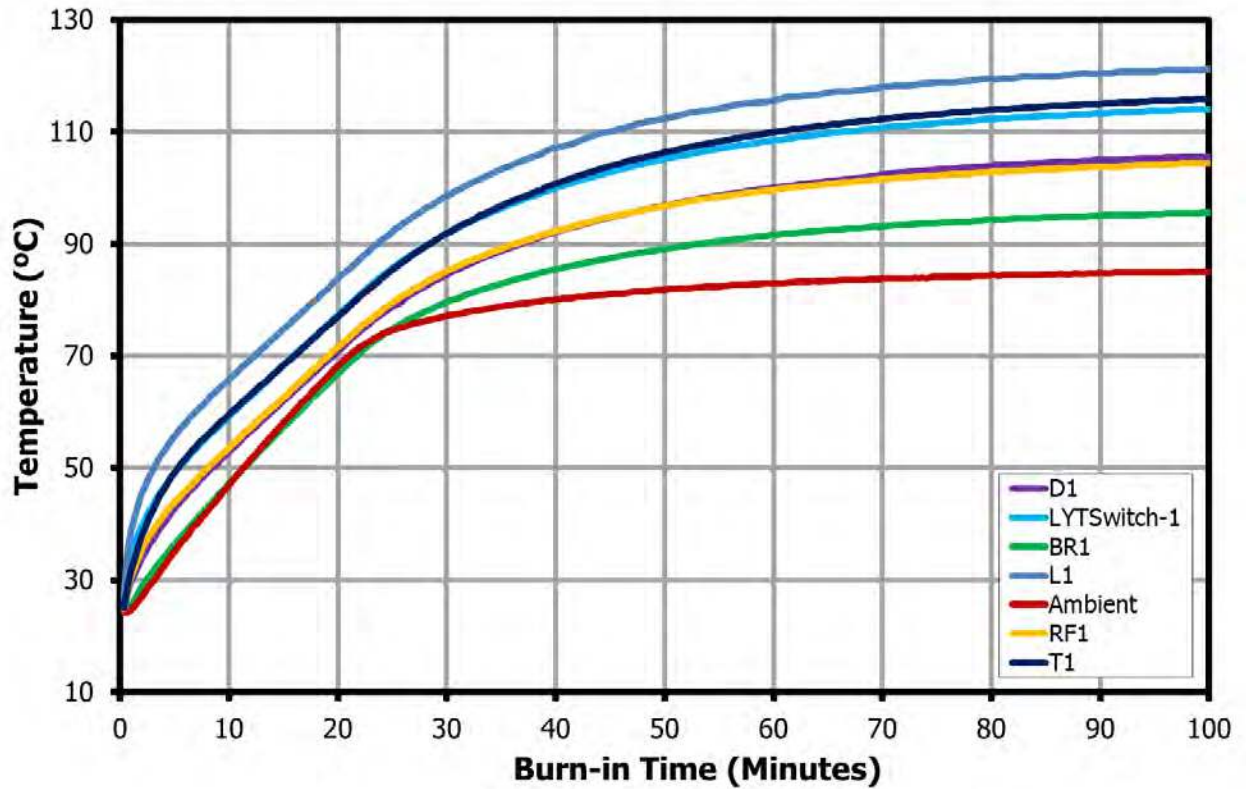

Figure 47 – Component Temperature at 90 VAC, 48 V LED Load, 85 °C Ambient.



11.2.2 Thermal Performance at 115 VAC with a 48 V LED Load

Measurement	Ambient	LYTswitch-1	BR1	D1	L1	T1	RF1
Maximum (°C)	85.6	109.3	93.4	103.6	110.0	109.4	99.8
Final (°C)	85.6	109.2	93.4	103.6	109.9	109.4	99.8

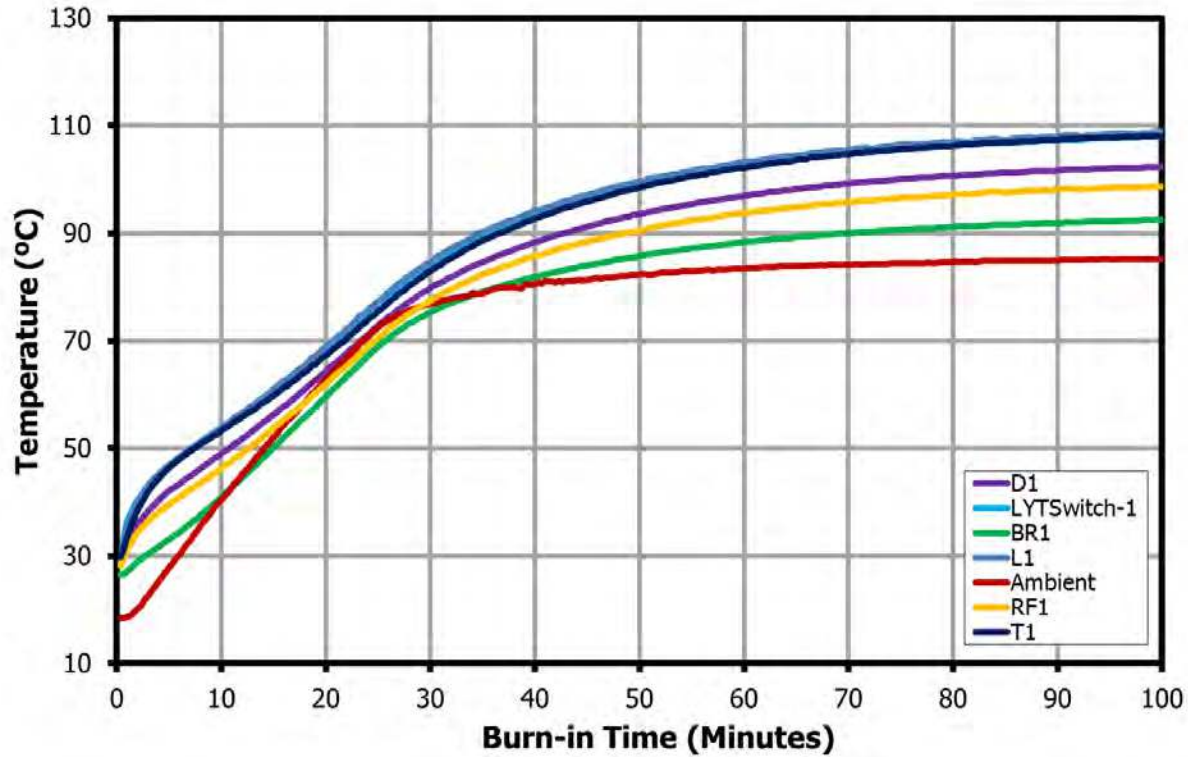

Figure 48 – Component Temperature at 115 VAC, 48 V LED Load, 85 °C Ambient.

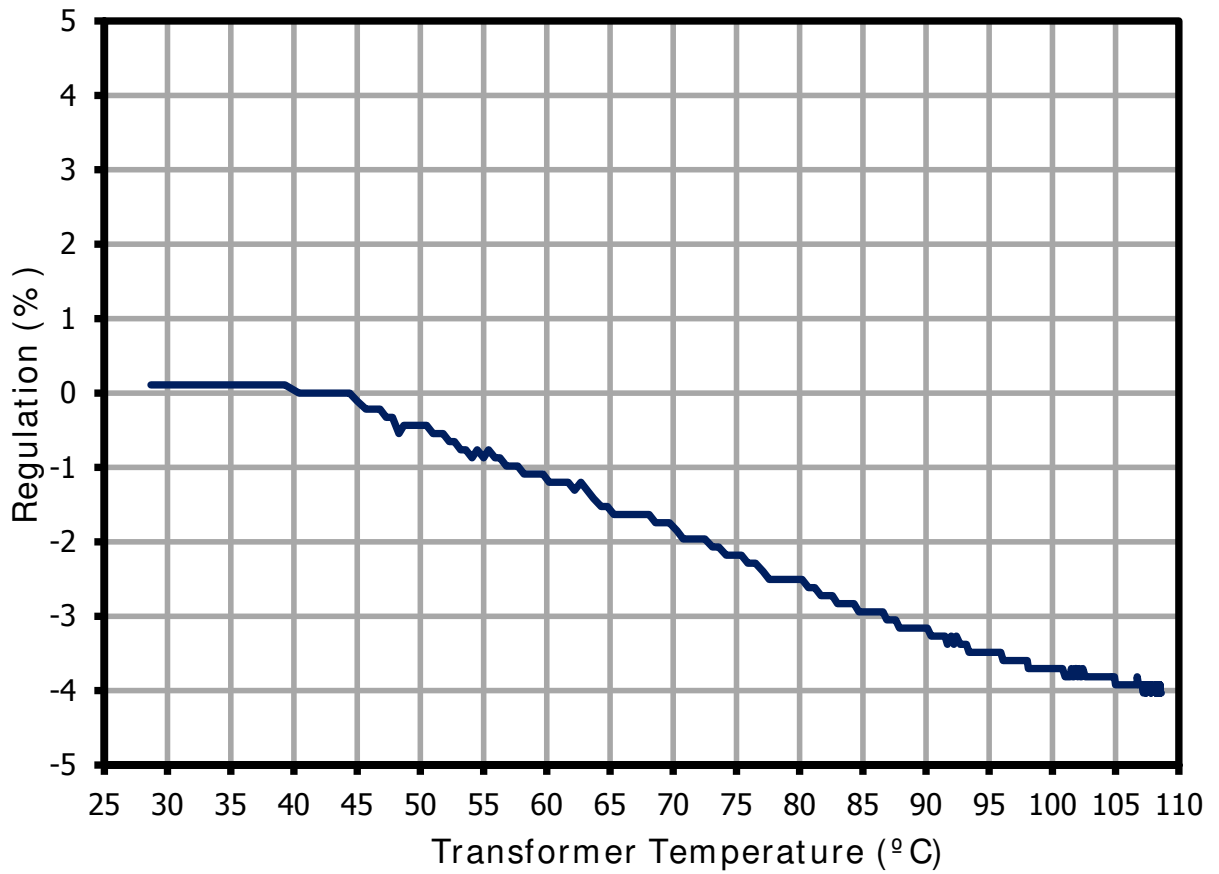

Figure 49 – Output Current Percent Regulation vs IC Temperature, 115 VAC, 48 V LED Load, 85 °C Ambient.



11.2.3 Thermal Performance at 230 VAC with a 48 V LED Load

Measurement	Ambient	LYTSwitch-1	BR1	D1	L1	T1	RF1
Maximum (°C)	85.5	111.9	92.4	107.4	105.4	113.9	97.8
Final (°C)	85.3	111.8	92.3	106.9	105.4	105.9	97.2

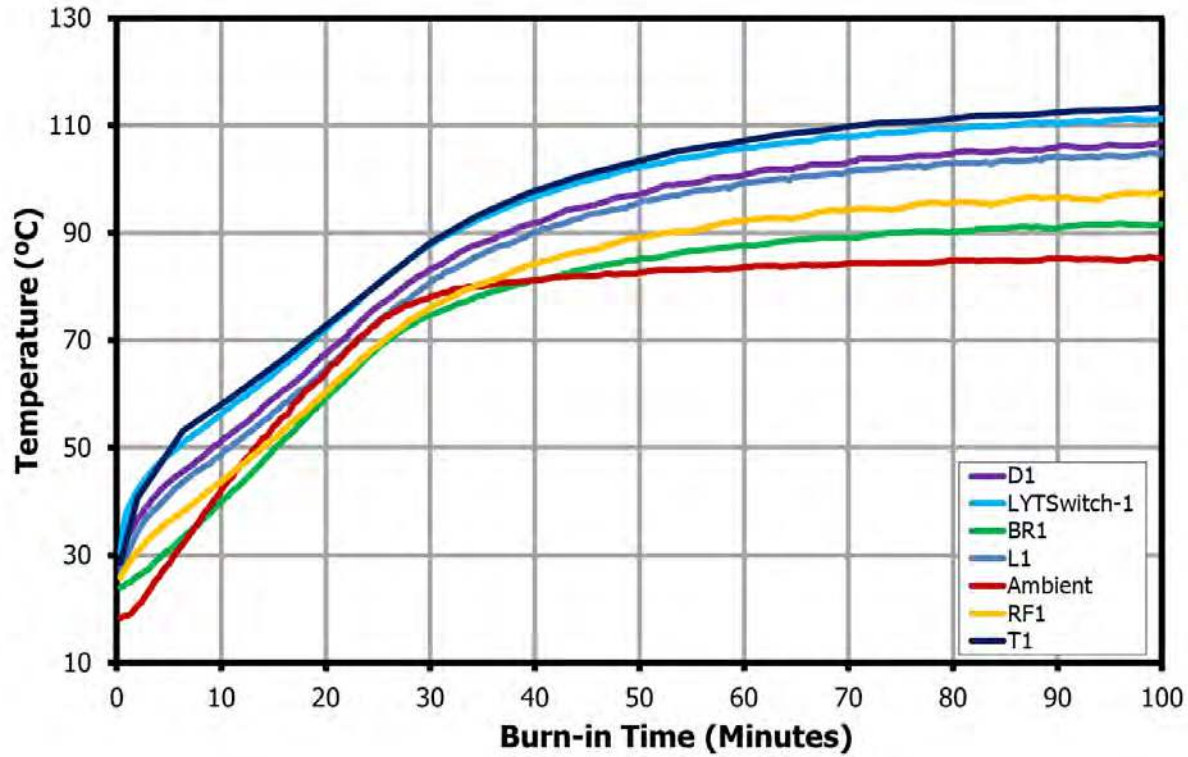

Figure 50 – Component Temperature at 230 VAC, 48 V LED Load, 85 °C Ambient.

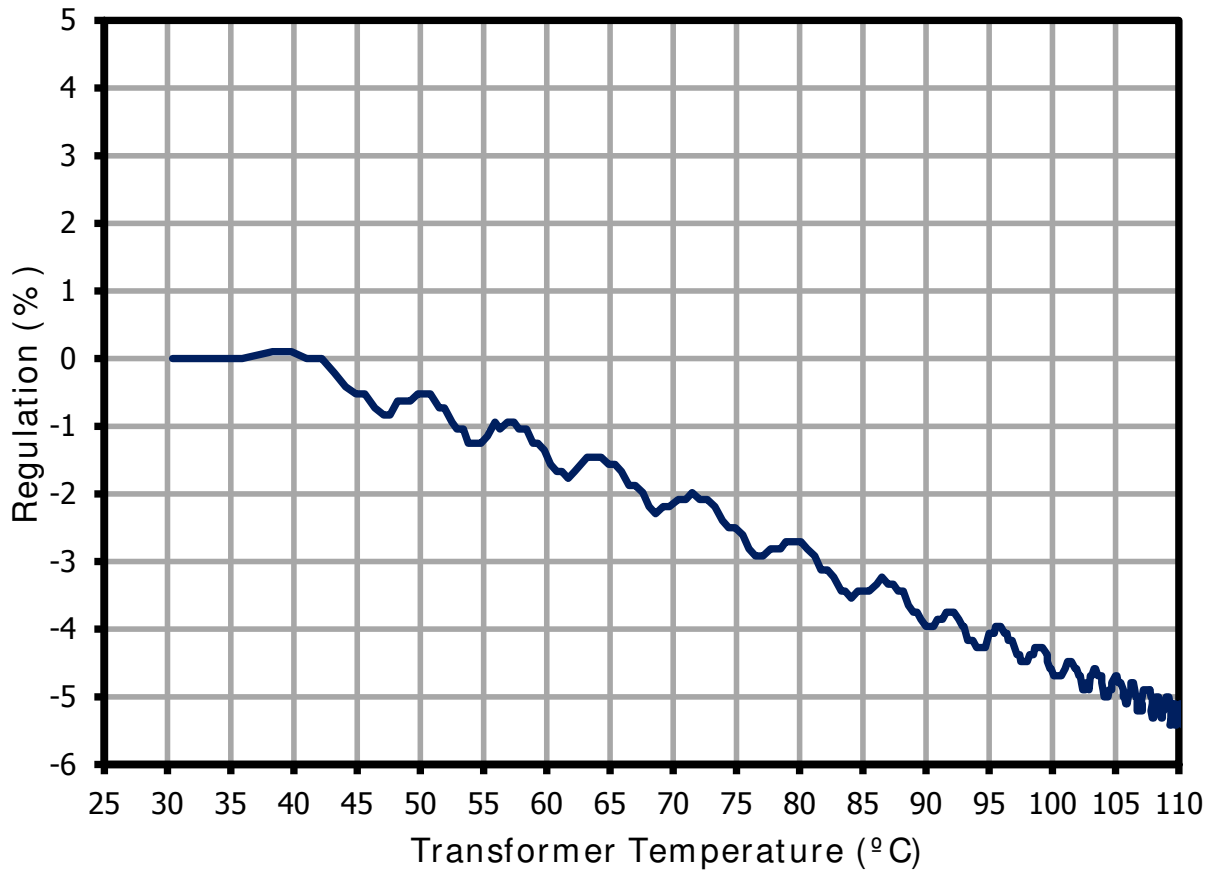

Figure 51 – Output Current Regulation vs. IC Temperature, 230 VAC, 48 V LED Load, 85 °C Ambient.



11.2.4 Thermal Performance at 300 VAC with a 48 V LED Load

Measurement	Ambient	LYT1	BR1	D1	L1	T1	RF1
Maximum	85.2	116.8	93.5	112.0	108.2	118.3	99.5
Final	84.9	116.6	93.4	112.0	108.0	114.5	99.5

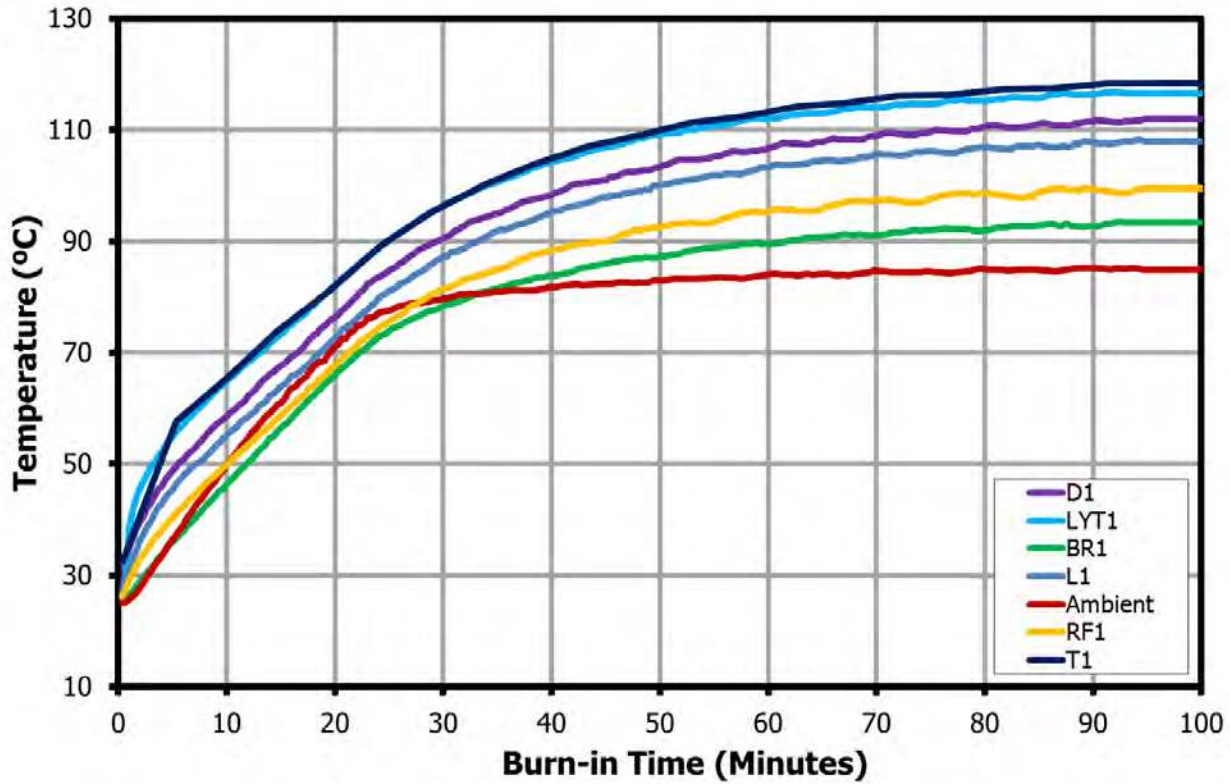

Figure 52 – Component Temperature at 300 VAC, 48 V LED Load, 85 °C Ambient.

12 Waveforms

12.1 *Input Voltage and Input Current Waveforms*

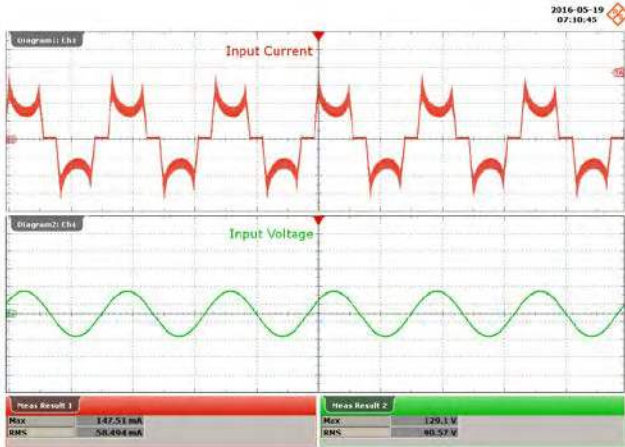

Figure 53 – 90 VAC, 48 V LED Load.
Upper: I_{IN} , 40 mA / div.
Lower: V_{IN} , 100 V / div., 10 ms / div.

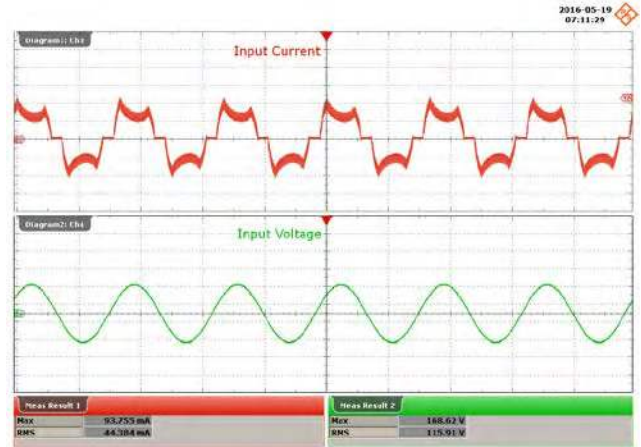

Figure 54 – 115 VAC, 48 V LED Load.
Upper: I_{IN} , 40 mA / div.
Lower: V_{IN} , 100 V / div., 10 ms / div.

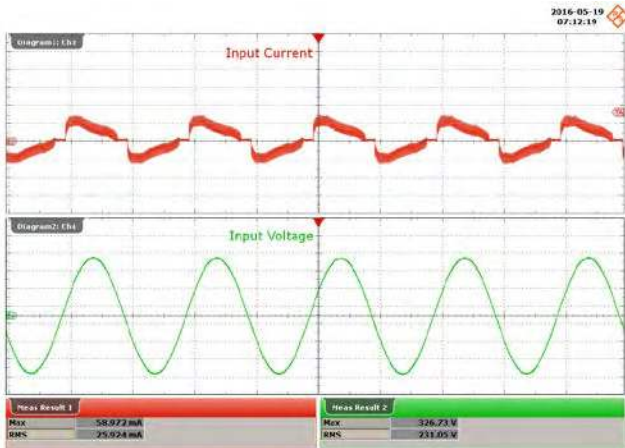

Figure 55 – 230 VAC, 48 V LED Load.
Upper: I_{IN} , 40 mA / div.
Lower: V_{IN} , 100 V / div., 10 ms / div.

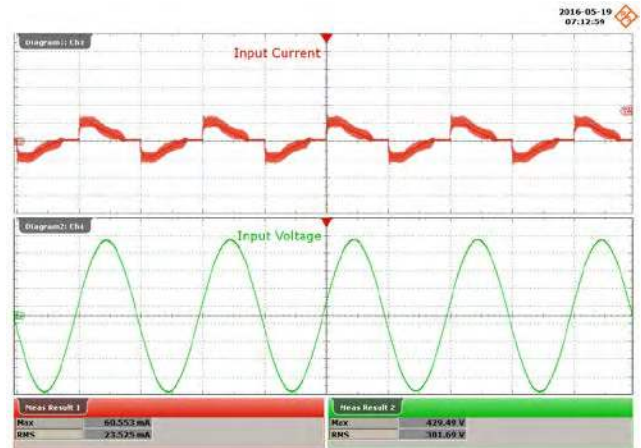

Figure 56 – 300 VAC, 48 V LED Load.
Upper: I_{IN} , 40 mA / div.
Lower: V_{IN} , 100 V / div., 10 ms / div.

12.2 Start-up Profile

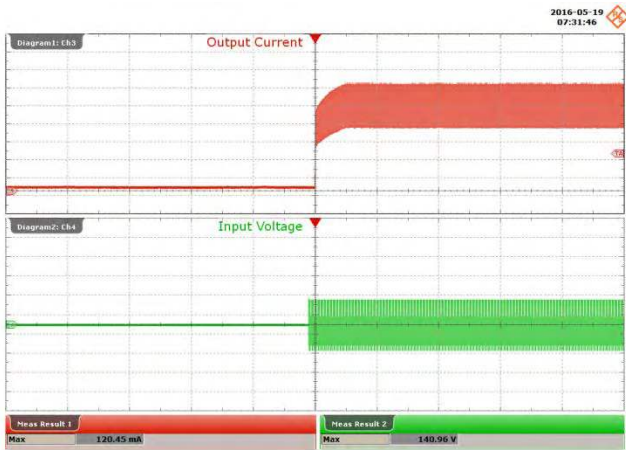

Figure 57 – 90 VAC, 48 V LED, Output Rise.
Upper: I_{OUT} , 40 mA / div.
Lower: V_{IN} , 100 V / div., 1 s / div.

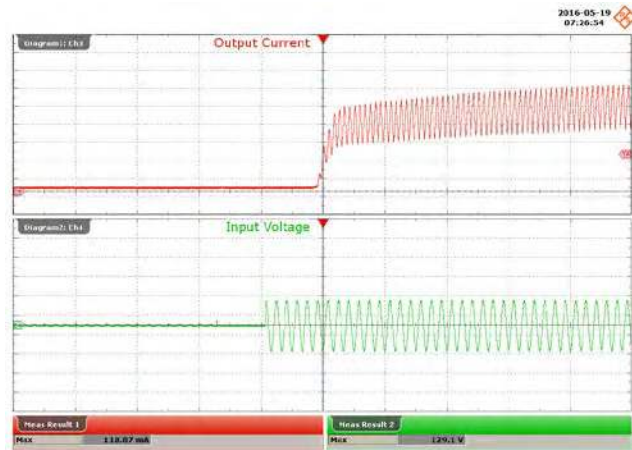

Figure 58 – 90 VAC, 48 V LED, Output Rise.
Upper: I_{OUT} , 40 mA / div.
Lower: V_{IN} , 100 V / div., 100 ms / div.

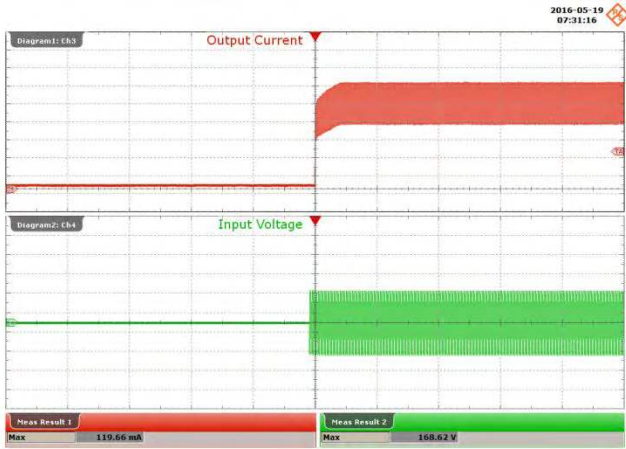

Figure 59 – 115 VAC, 48 V LED, Output Rise.
Upper: I_{OUT} , 40 mA / div.
Lower: V_{IN} , 100 V / div., 1 s / div.

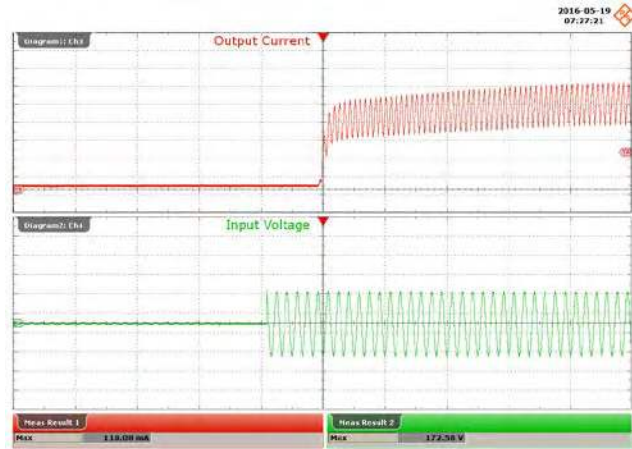

Figure 60 – 115 VAC, 48 V LED, Output Rise.
Upper: I_{OUT} , 40 mA / div.
Lower: V_{IN} , 100 V / div., 100 ms / div.

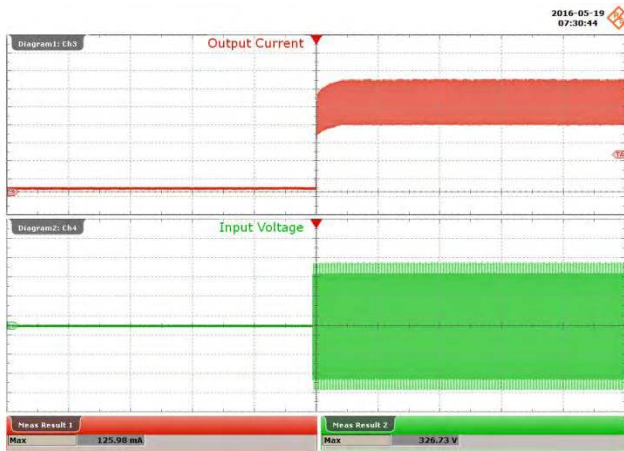

Figure 61 – 230 VAC, 48 V LED, Output Rise.
 Upper: I_{OUT} , 40 mA / div.
 Lower: V_{IN} , 100 V / div., 1 s / div.



Figure 62 – 230 VAC, 48 V LED, Output Rise.
 Upper: I_{OUT} , 40 mA / div.
 Lower: V_{IN} , 100 V / div., 100 ms / div.

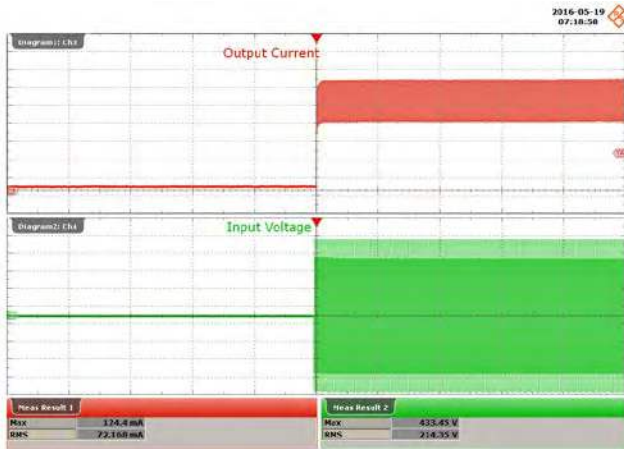

Figure 63 – 30 VAC, 48 V LED, Output Rise.
 Upper: I_{OUT} , 40 mA / div.
 Lower: V_{IN} , 100 V / div., 1 s / div.

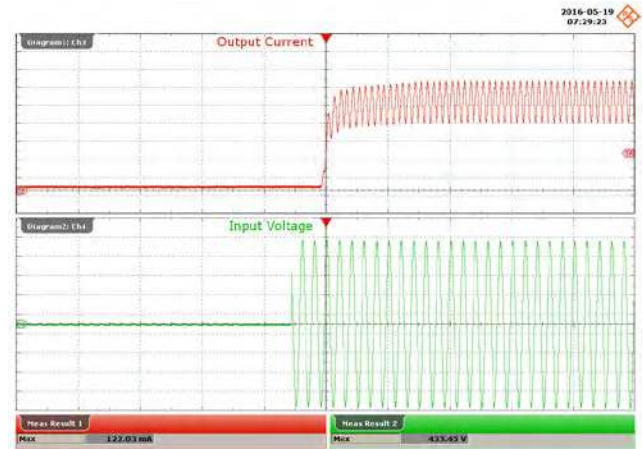

Figure 64 – 300 VAC, 48 V LED Load, Output Rise.
 Upper: I_{OUT} , 40 mA / div.
 Lower: V_{IN} , 100 V / div., 100 ms / div.

12.3 Output Current Fall

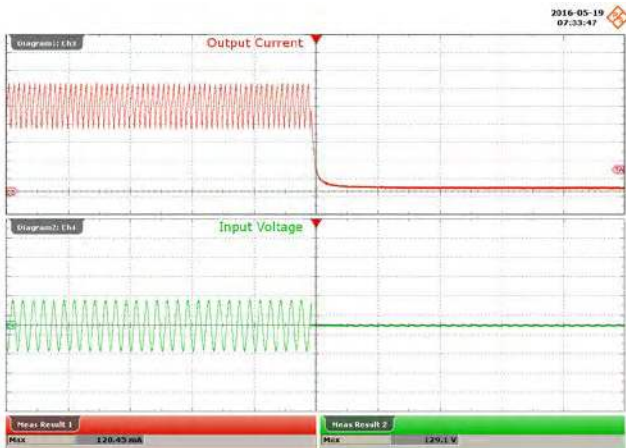

Figure 65 – 90 VAC, 48 V LED, Output Fall.
 Upper: I_{OUT} , 40 mA / div.
 Lower: V_{IN} , 100 V / div., 100 ms / div.

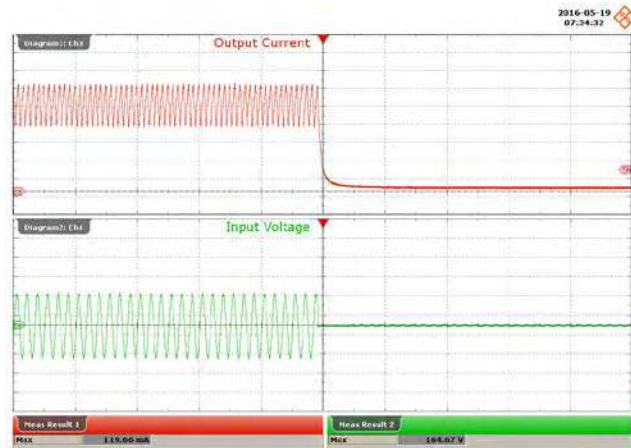

Figure 66 – 115 VAC, 48 V LED, Output Fall.
 Upper: I_{OUT} , 40 mA / div.
 Lower: V_{IN} , 100 V / div., 100 ms / div.

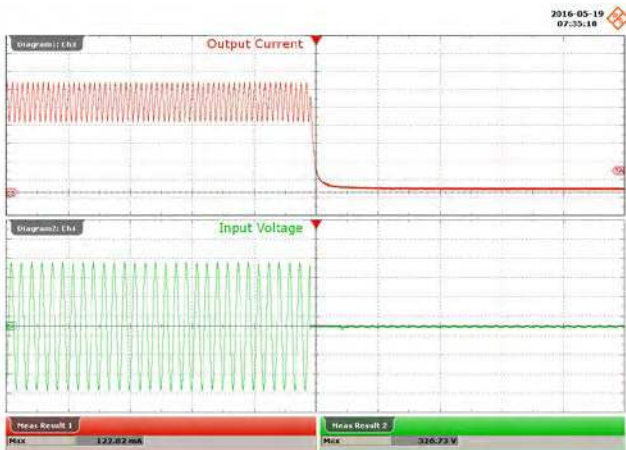

Figure 67 – 230 VAC, 48 V LED, Output Fall.
 Upper: I_{OUT} , 40 mA / div.
 Lower: V_{IN} , 100 V / div., 100 ms / div.

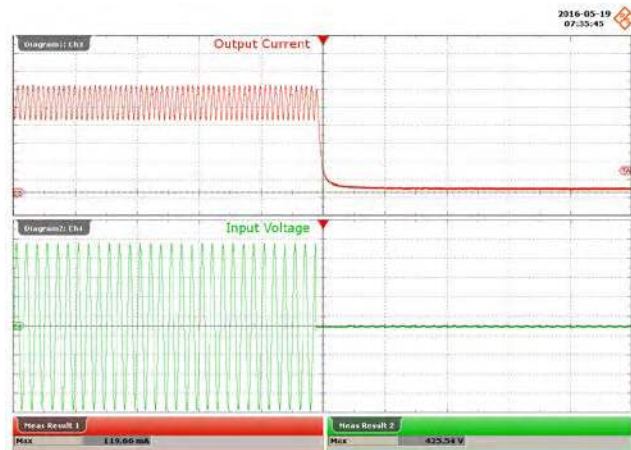

Figure 68 – 230 VAC, 48 V LED, Output Fall.
 Upper: I_{OUT} , 40 mA / div.
 Lower: V_{IN} , 100 V / div., 100 ms / div.

12.4 Drain Voltage and Current in Normal Operation

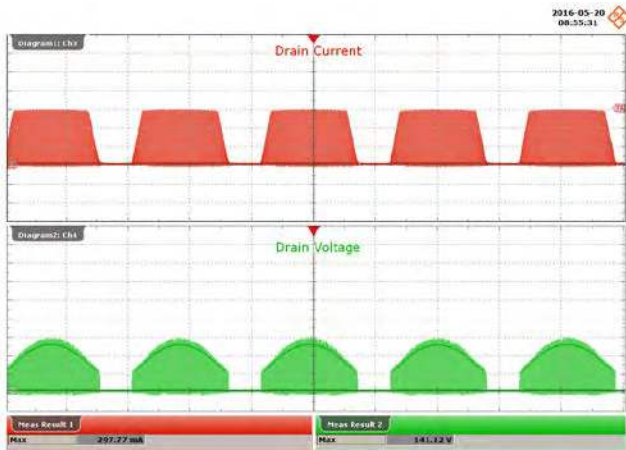

Figure 69 – 90 VAC, 48 V LED Load.
 Upper: I_{DRAIN} , 100 mA / div.
 Lower: V_{DRAIN} , 50 V / div., 4 ms / div.



Figure 70 – 90 VAC, 48 V LED Load.
 Upper: I_{DRAIN} , 100 mA / div.
 Lower: V_{DRAIN} , 50 V / div., 5 μ s / div.

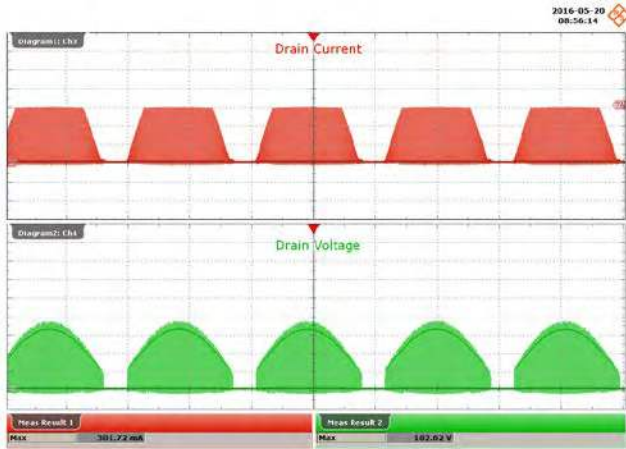

Figure 71 – 115 VAC, 48 V LED Load.
 Upper: I_{DRAIN} , 100 mA / div.
 Lower: V_{DRAIN} , 50 V / div., 4 ms / div.



Figure 72 – 115 VAC, 48 V LED Load.
 Upper: I_{DRAIN} , 100 mA / div.
 Lower: V_{DRAIN} , 50 V / div., 5 μ s / div.



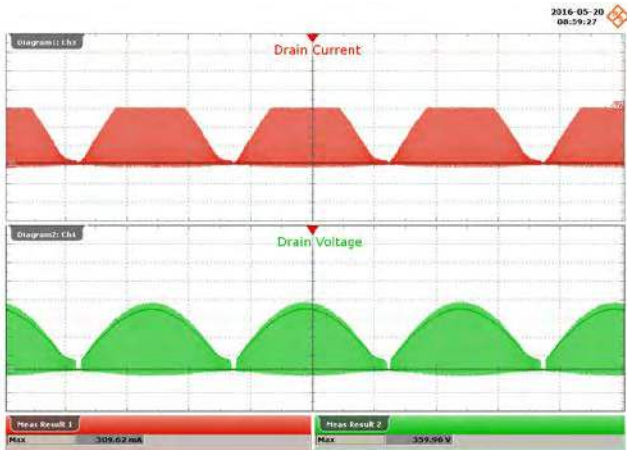

Figure 73 – 230 VAC, 48 V LED Load.
 Upper: I_{DRAIN} , 100 mA / div.
 Lower: V_{DRAIN} , 100 V / div., 4 ms / div.



Figure 74 – 230 VAC, 48 V LED Load.
 Upper: I_{DRAIN} , 100 mA / div.
 Lower: V_{DRAIN} , 100 V / div., 5 μ s / div.

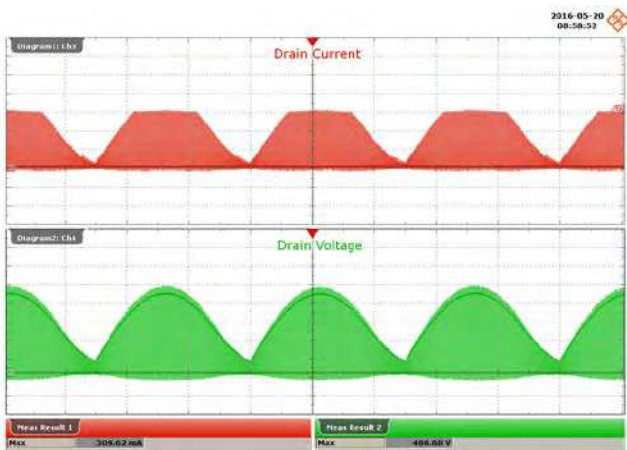

Figure 75 – 300 VAC, 48 V LED Load.
 Upper: I_{DRAIN} , 100 mA / div.
 Lower: V_{DRAIN} , 100 V / div., 4 ms / div.



Figure 76 – 300 VAC, 48 V LED Load.
 Upper: I_{DRAIN} , 100 mA / div.
 Lower: V_{DRAIN} , 100 V / div., 5 μ s / div.

12.5 Drain Voltage and Current Start-up Profile



Figure 77 – 90 VAC, 48 V LED Load.
 Upper: I_{DRAIN} , 100 mA / div.
 Lower: V_{DRAIN} , 50 V / div., 20 ms / div.

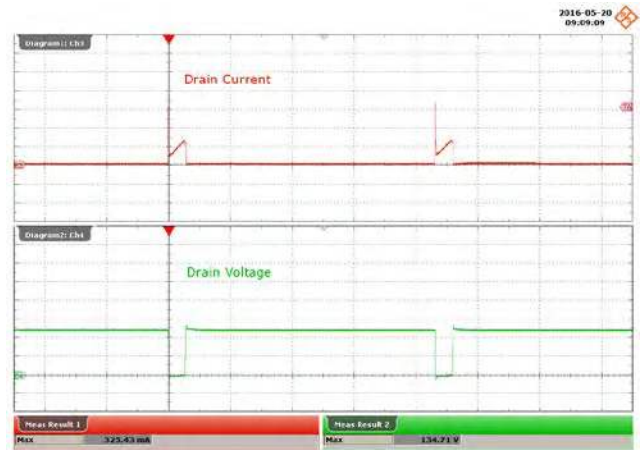

Figure 78 – 90 VAC, 48 V LED Load.
 Upper: I_{DRAIN} , 100 mA / div.
 Lower: V_{DRAIN} , 50 V / div., 4 μ s / div.



Figure 79 – 300 VAC, 48 V LED Load.
 Upper: I_{DRAIN} , 100 mA / div.
 Lower: V_{DRAIN} , 100 V / div., 20 ms / div.

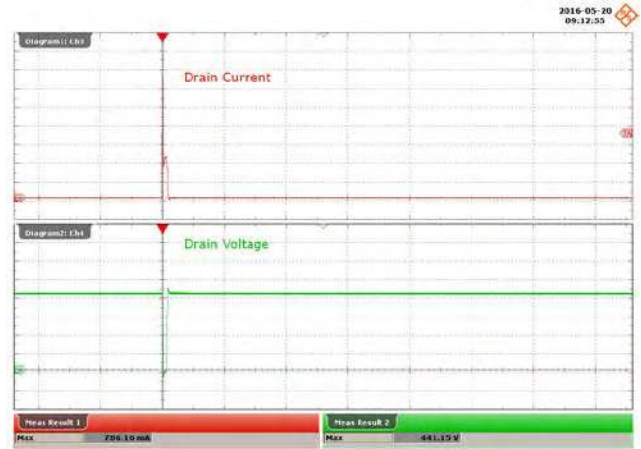

Figure 80 – 300 VAC, 48 V LED Load.
 Upper: I_{DRAIN} , 100 mA / div.
 Lower: V_{DRAIN} , 100 V / div., 4 μ s / div.



12.6 Drain Voltage and Current During Output Short-Circuit

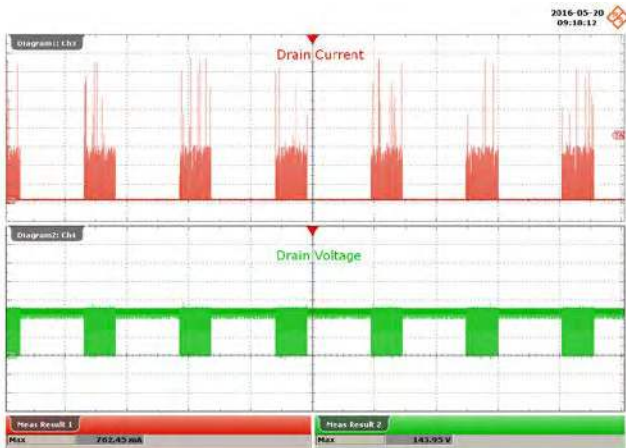

Figure 81 – 90 VAC, Output Short-Circuit.
 Upper: I_{DRAIN} , 100 mA / div.
 Lower: V_{DRAIN} , 50 V / div., 1 s / div.

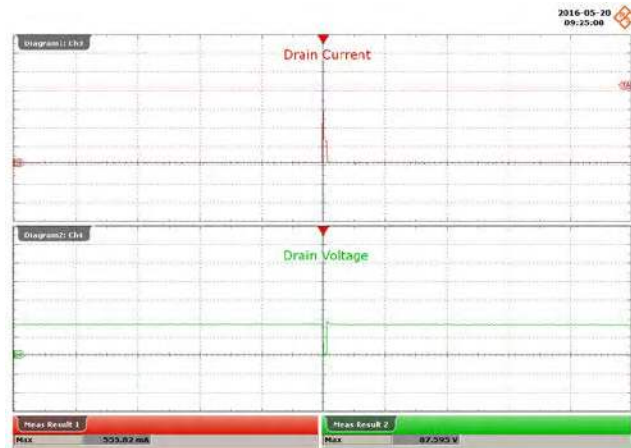

Figure 82 – 90 VAC, Output Short-Circuit.
 Upper: I_{DRAIN} , 100 mA / div.
 Lower: V_{DRAIN} , 50 V / div., 2 μ s / div.

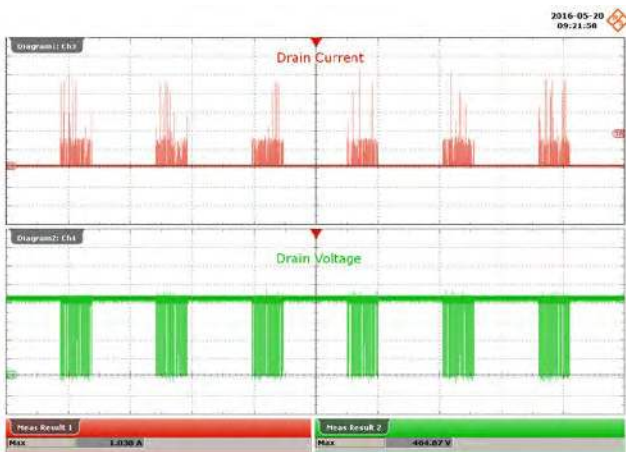

Figure 83 – 300 VAC, 48 V LED Load.
 Upper: I_{DRAIN} , 200 mA / div.
 Lower: V_{DRAIN} , 100 V / div., 20 ms / div.

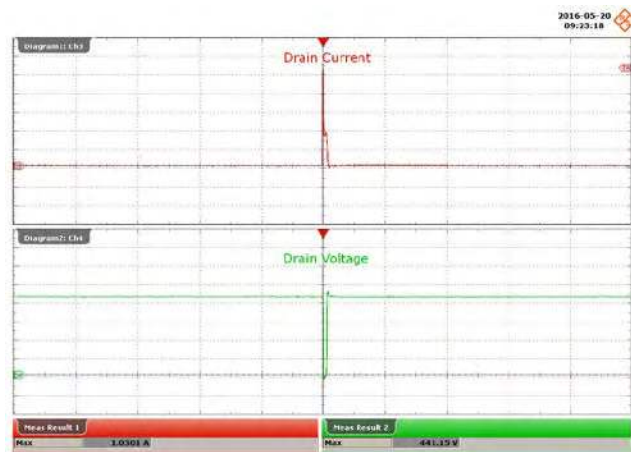

Figure 84 – 300 VAC, 48 V LED Load.
 Upper: I_{DRAIN} , 200 mA / div.
 Lower: V_{DRAIN} , 100 V / div., 4 μ s / div.

12.7 Output Diode Voltage and Current in Normal Operation

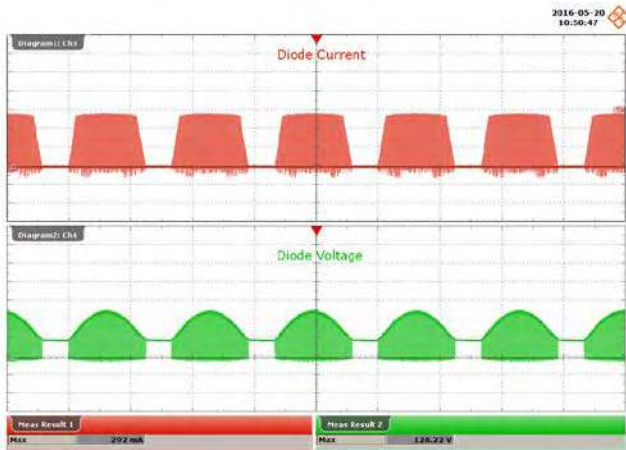

Figure 85 – 90 VAC, 48 V LED Load.
 Upper: I_{D1} , 100 mA / div.
 Lower: V_{D1} , 50 V / div., 4 ms / div.

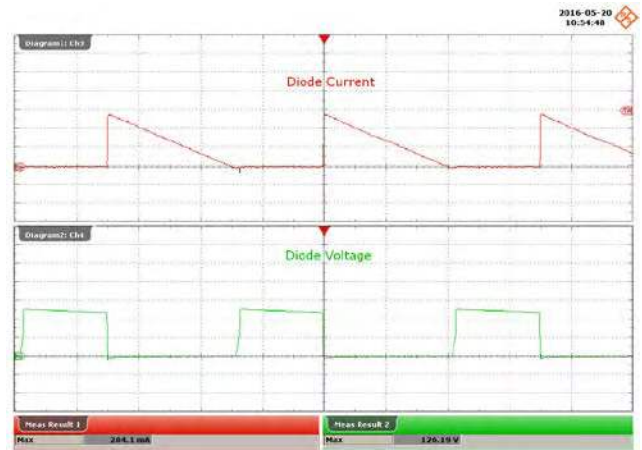

Figure 86 – 90 VAC, 48 V LED Load.
 Upper: I_{D1} , 100 mA / div.
 Lower: V_{D1} , 50 V / div., 4 μ s / div.

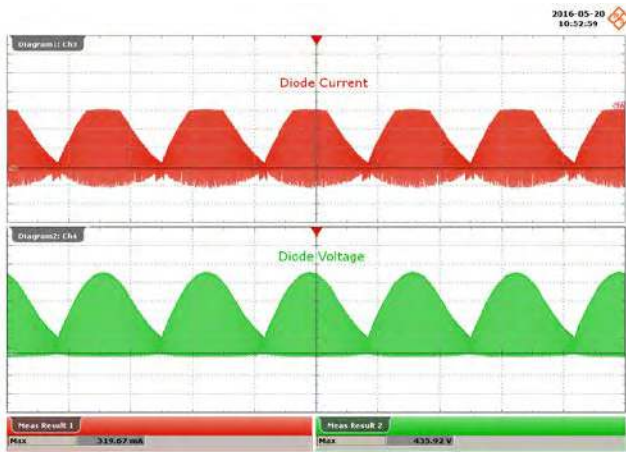

Figure 87 – 300 VAC, 48 V LED Load.
 Upper: I_{D1} , 100 mA / div.
 Lower: V_{D1} , 100 V / div., 4 ms / div.

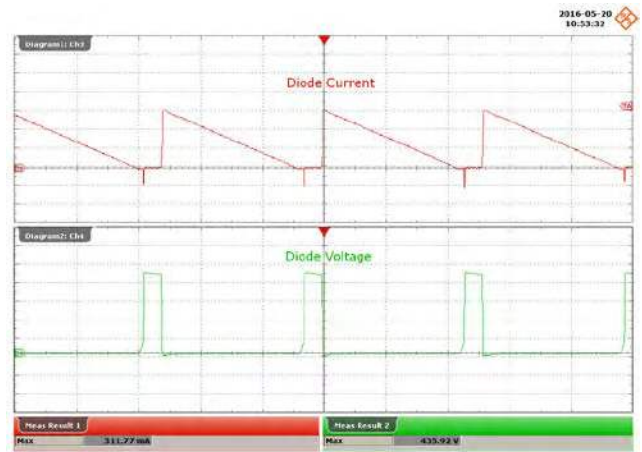

Figure 88 – 300 VAC, 48 V LED Load.
 Upper: I_{D1} , 100 mA / div.
 Lower: V_{D1} , 100 V / div., 4 μ s / div.



12.8 Output Voltage and Current – Open Output LED Load

Maximum measured no-load output voltage is below the surge voltage rating of the output capacitor.

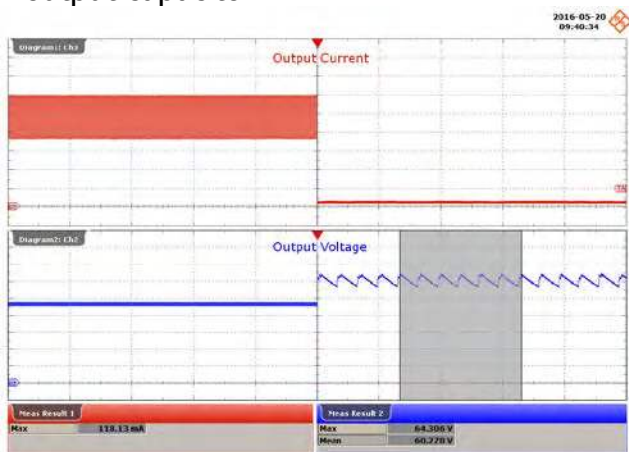

Figure 89 – 90 VAC, 48 V LED Load.
Running Open Load.
Upper: I_{OUT}, 20 mA / div.
Lower: V_{OUT}, 10 V / div., 4 s / div.

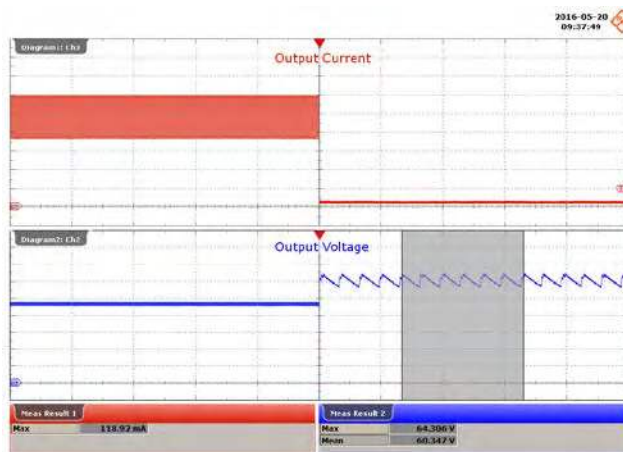

Figure 90 – 115 VAC, 48 V LED Load.
Running Open Load.
Upper: I_{OUT}, 20 mA / div.
Lower: V_{OUT}, 10 V / div., 4 s / div.

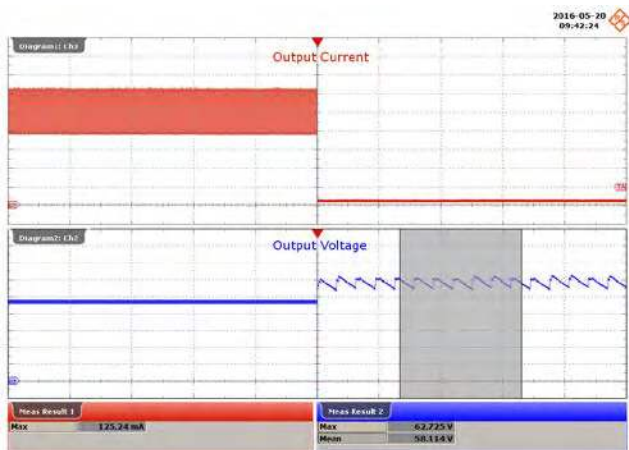

Figure 91 – 230 VAC, Open Load.
Running Open Load.
Upper: I_{OUT}, 20 mA / div.
Lower: V_{OUT}, 10 V / div., 4 s / div.

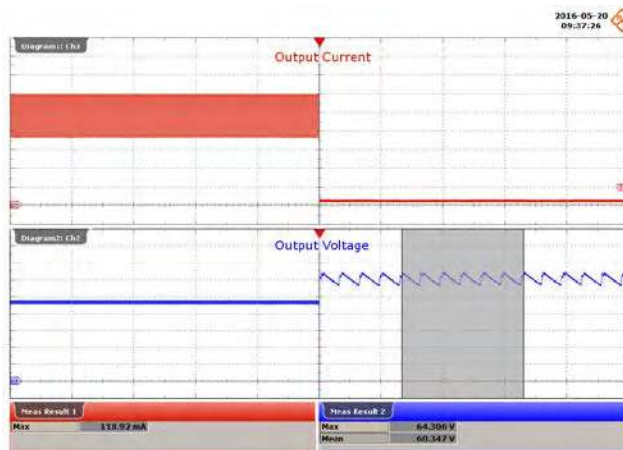

Figure 92 – 300 VAC, Open Load.
Running Open Load.
Upper: I_{OUT}, 20 mA / div.
Lower: V_{OUT}, 10 V / div., 4 s / div.

12.9 Output Voltage and Current – Start-up at Open Output Load

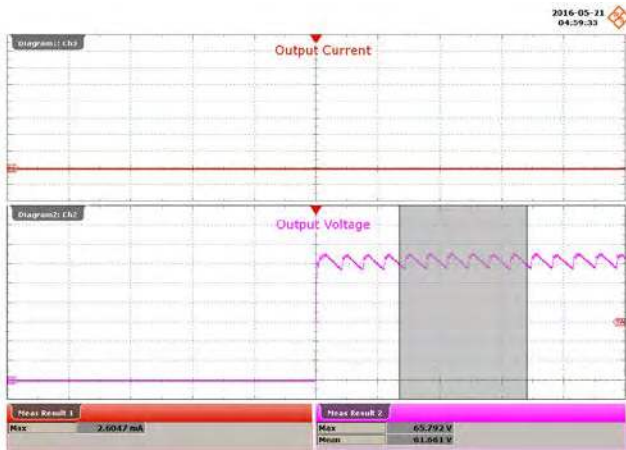

Figure 93 – 230 VAC, Open Load.
 Open Load Start-up.
 Upper: I_{OUT} , 40 mA / div.
 Lower: V_{OUT} , 10 V / div., 4 s / div.

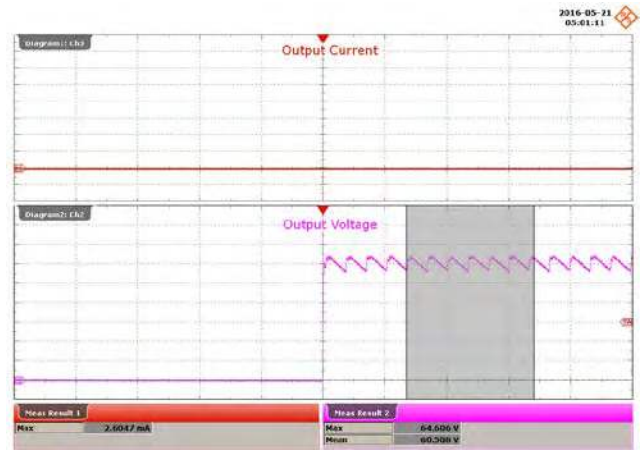

Figure 94 – 300 VAC, Open Load.
 Open Load Start-up.
 Upper: I_{OUT} , 40 mA / div.
 Lower: V_{OUT} , 10 V / div., 4 s / div.

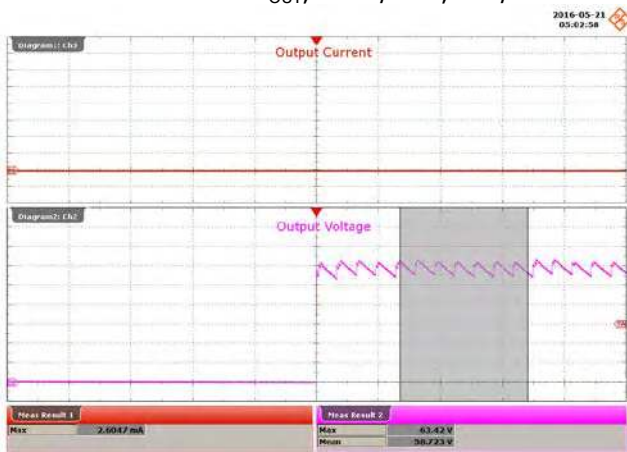

Figure 95 – 230 VAC, Open Load.
 Open Load Start-up.
 Upper: I_{OUT} , 40 mA / div.
 Lower: V_{OUT} , 10 V / div., 4 s / div.



Figure 96 – 300 VAC, Open Load.
 Open Load Start-up.
 Upper: I_{OUT} , 40 mA / div.
 Lower: V_{OUT} , 10 V / div., 4 s / div.



12.10 *Output Ripple Current*

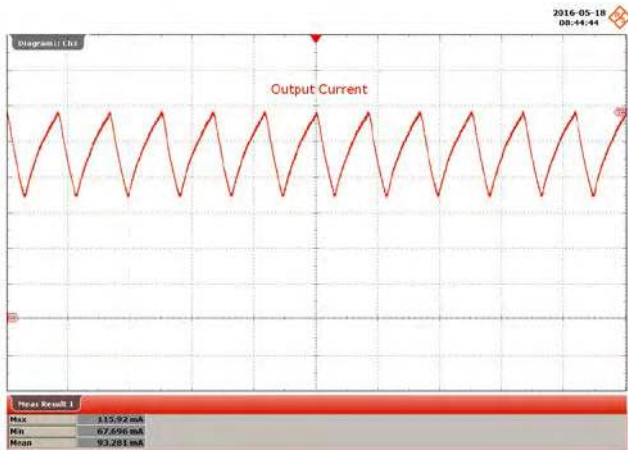

Figure 97 – 90 VAC, 60 Hz, 48 V LED Load.
Upper: I_{OUT} , 20 mA / div., 10 ms / div.

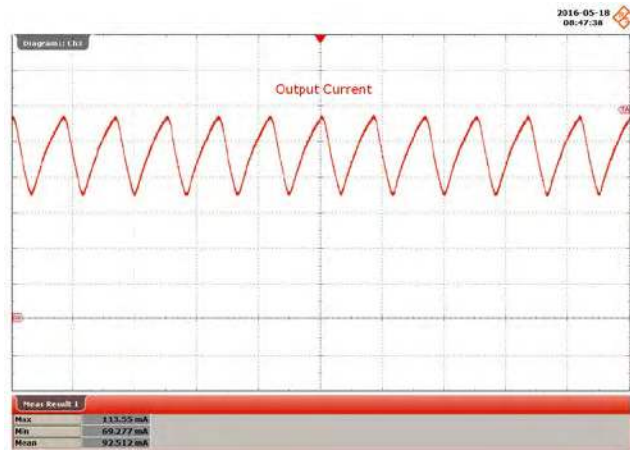

Figure 98 – 115 VAC, 60 Hz, 48 V LED Load.
Upper: I_{OUT} , 20 mA / div., 10 ms / div.

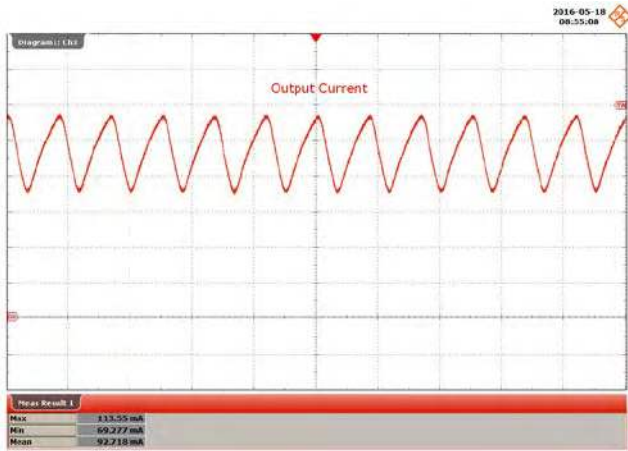

Figure 99 – 132 VAC, 60 Hz, 48 V LED Load.
Upper: I_{OUT} , 50 mA / div., 10 ms / div.

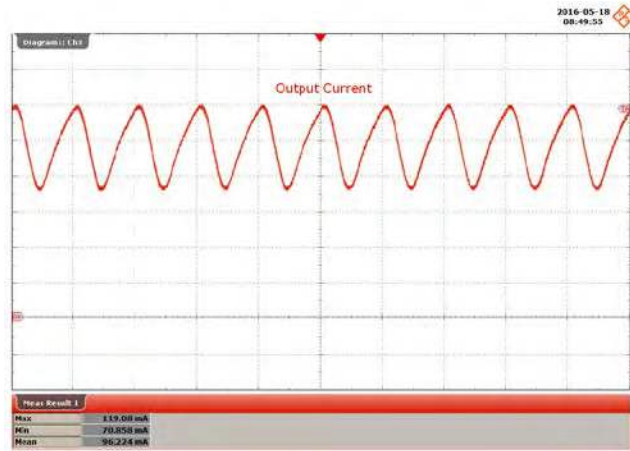

Figure 100 – 300 VAC, 60 Hz, 48 V LED Load.
Upper: I_{OUT} , 50 mA / div., 10 ms / div.

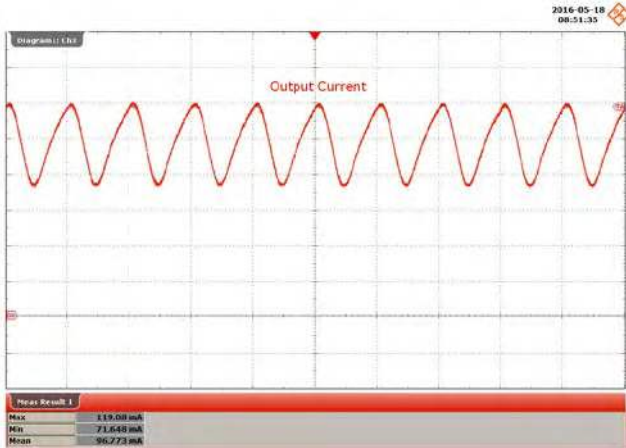

Figure 101 – 230 VAC, 60 Hz, 48 V LED Load.
Upper: I_{OUT} , 50 mA / div., 10 ms / div.

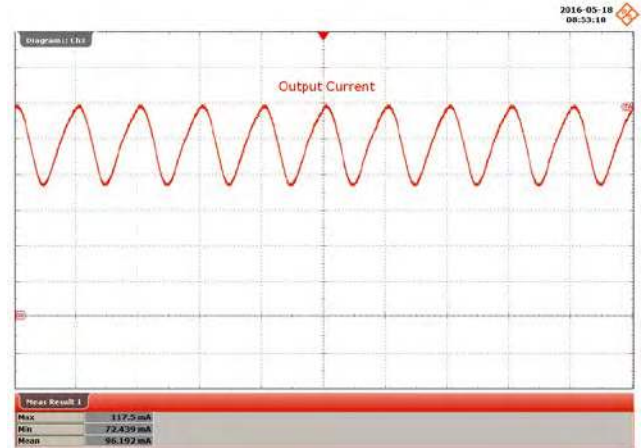

Figure 102 – 300 VAC, 60 Hz, 48 V LED Load.
Upper: I_{OUT} , 50 mA / div., 10 ms / div.

V_{IN} (VAC)	$I_{OUT(MAX)}$ (mA)	$I_{OUT(MIN)}$ (mA)	I_{MEAN}	Ripple Ratio (I_{RP-P} / I_{MEAN})	% Flicker $100 \times (I_{RP-P} / I_{O(MAX)} + I_{O(MIN)})$
90	115.92	67.69	93.28	0.52	26.26
115	113.55	69.27	92.51	0.48	24.22
132	113.55	69.27	92.71	0.48	24.22
230	119.08	70.85	96.22	0.50	25.39
265	119.08	71.64	96.77	0.49	24.87
300	117.50	72.43	96.19	0.47	23.72

13 AC Cycling Test

No output current overshoot was observed during on - off cycling.

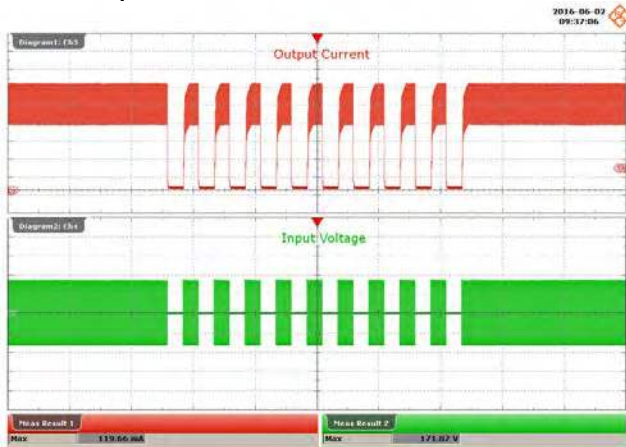

Figure 103 – 115 VAC, 48 V LED Load.
 1 s On – 1 s Off.
 Upper: I_{OUT} , 20 mA / div.
 Lower: V_{IN} , 100 V / div., 4 s / div.

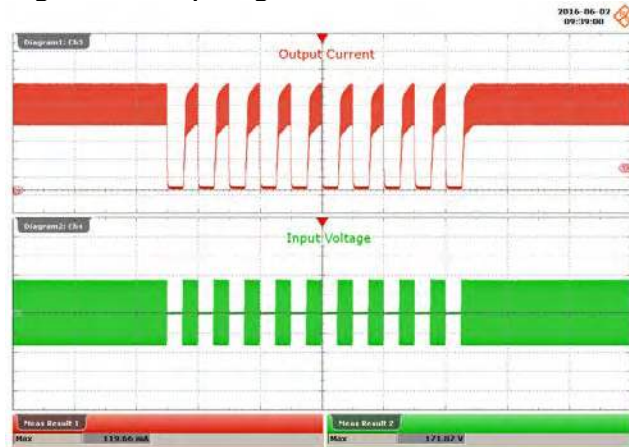

Figure 104 – 115 VAC, 48 V LED Load.
 0.5 s On – 0.5 s Off.
 Upper: I_{OUT} , 20 mA / div.
 Lower: V_{IN} , 100 V / div., 2 s / div.

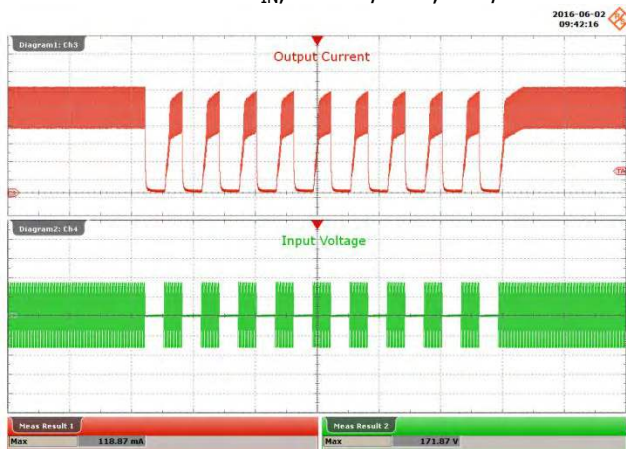

Figure 105 – 115 VAC, 48 V LED Load.
 300 ms On – 300 ms Off.
 Upper: I_{OUT} , 20 mA / div.
 Lower: V_{IN} , 100 V / div., 1 s / div.

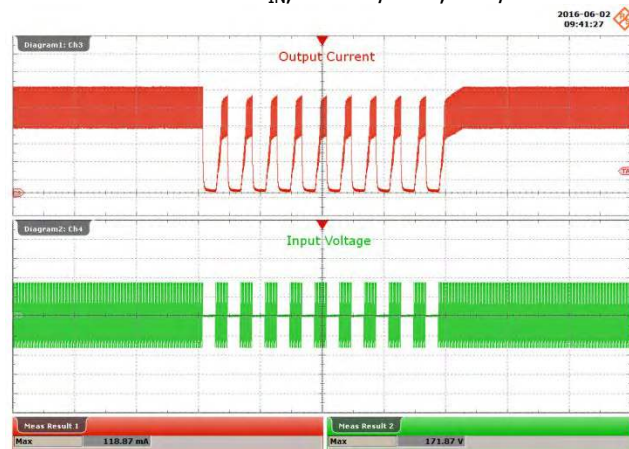

Figure 106 – 115 VAC, 48 V LED Load.
 200 ms On – 200 ms Off.
 Upper: I_{OUT} , 20 mA / div.
 Lower: V_{IN} , 100 V / div., 1 s / div.

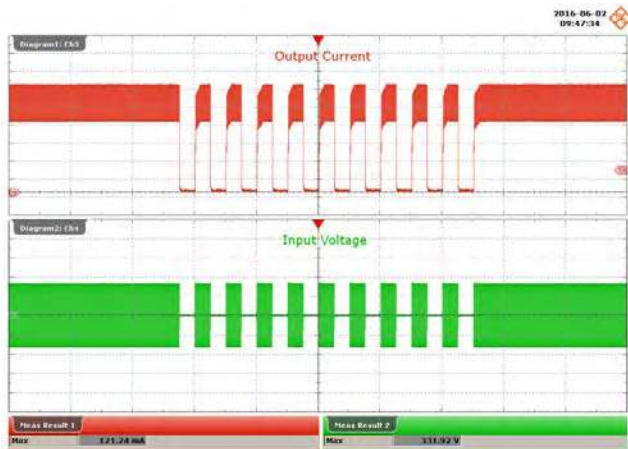

Figure 107 – 230 VAC, 48 V LED Load.
 1 s On – 1 s Off.
 Upper: I_{OUT} , 20 mA / div.
 Lower: V_{IN} , 200 V / div., 4 s / div.

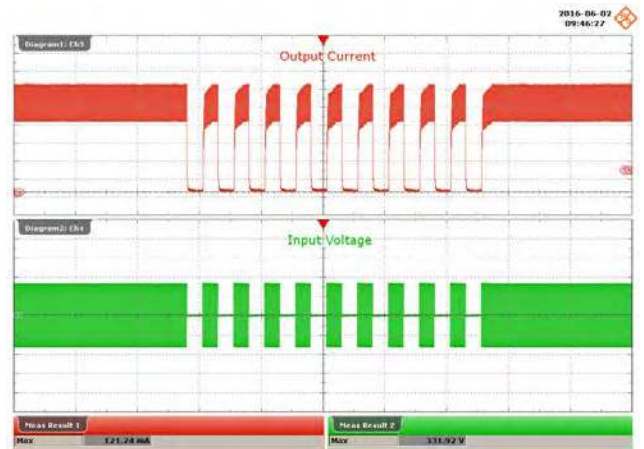

Figure 108 – 230 VAC, 48 V LED Load.
 0.5 s On – 0.5 s Off.
 Upper: I_{OUT} , 20 mA / div.
 Lower: V_{IN} , 200 V / div., 2 s / div.

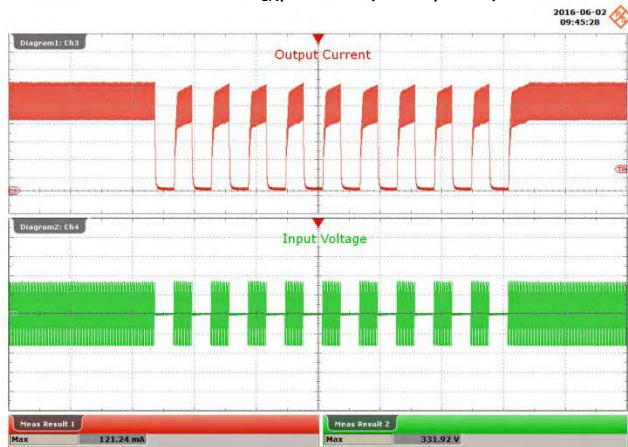

Figure 109 – 230 VAC, 48 V LED Load.
 300 ms On – 300 ms Off.
 Upper: I_{OUT} , 20 mA / div.
 Lower: V_{IN} , 200 V / div., 1 s / div.

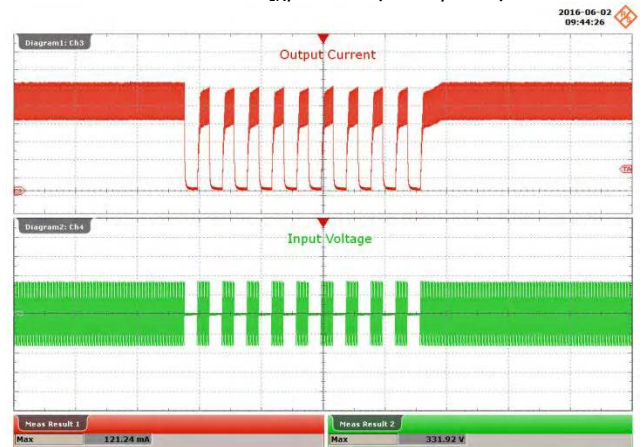

Figure 110 – 230 VAC, 48 V LED Load.
 200 ms On – 200 ms Off.
 Upper: I_{OUT} , 20 mA / div.
 Lower: V_{IN} , 200 V / div., 1 s / div.



14 Conducted EMI

14.1 *Test Set-up*

14.1.1 Equipment and Load Used

1. Rohde and Schwarz ENV216 two line V-network.
2. Rohde and Schwarz ESRP EMI test receiver.
3. Hioki 3322 power hitester.
4. Chroma measurement test fixture.
5. 48 V LED load with input voltage set at 115 VAC and 230 VAC.

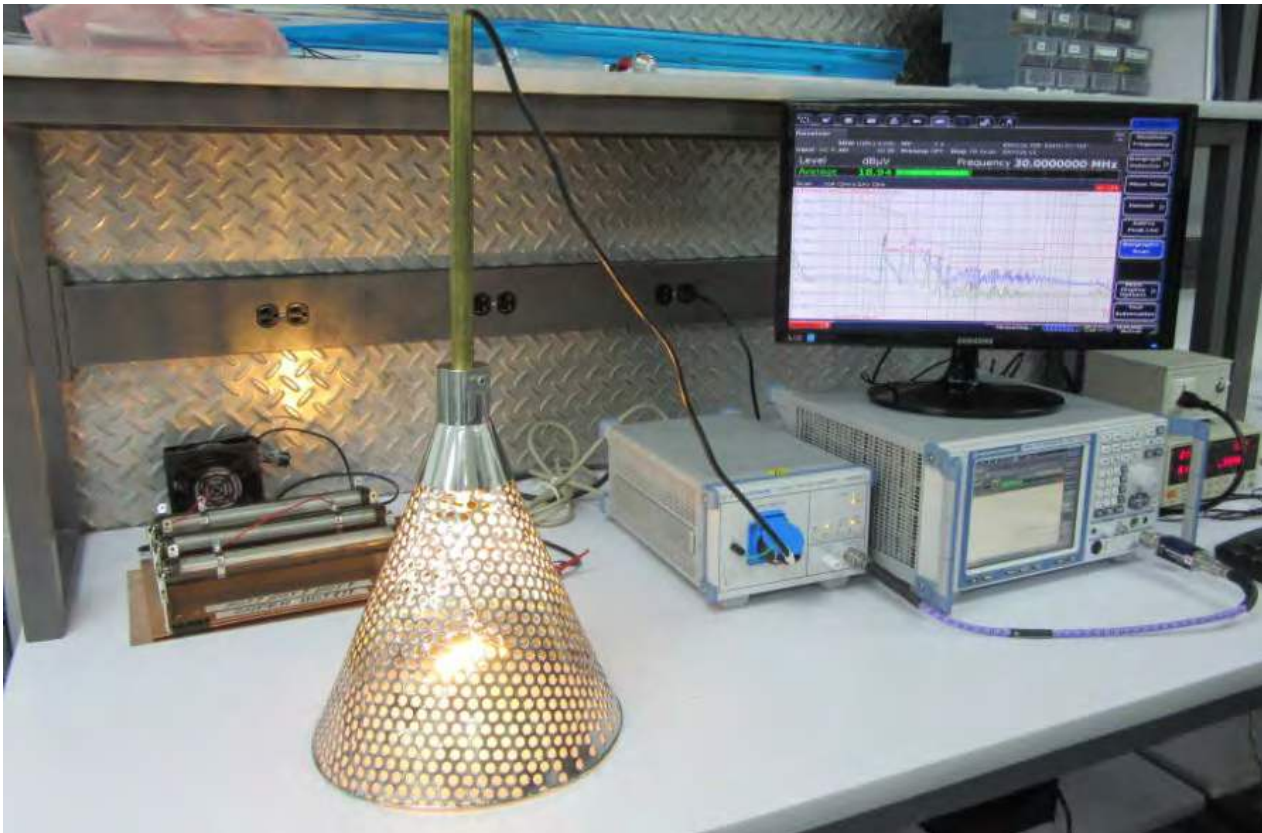

Figure 111 – Conducted EMI Test Set-up.

14.2 EMI Test Result

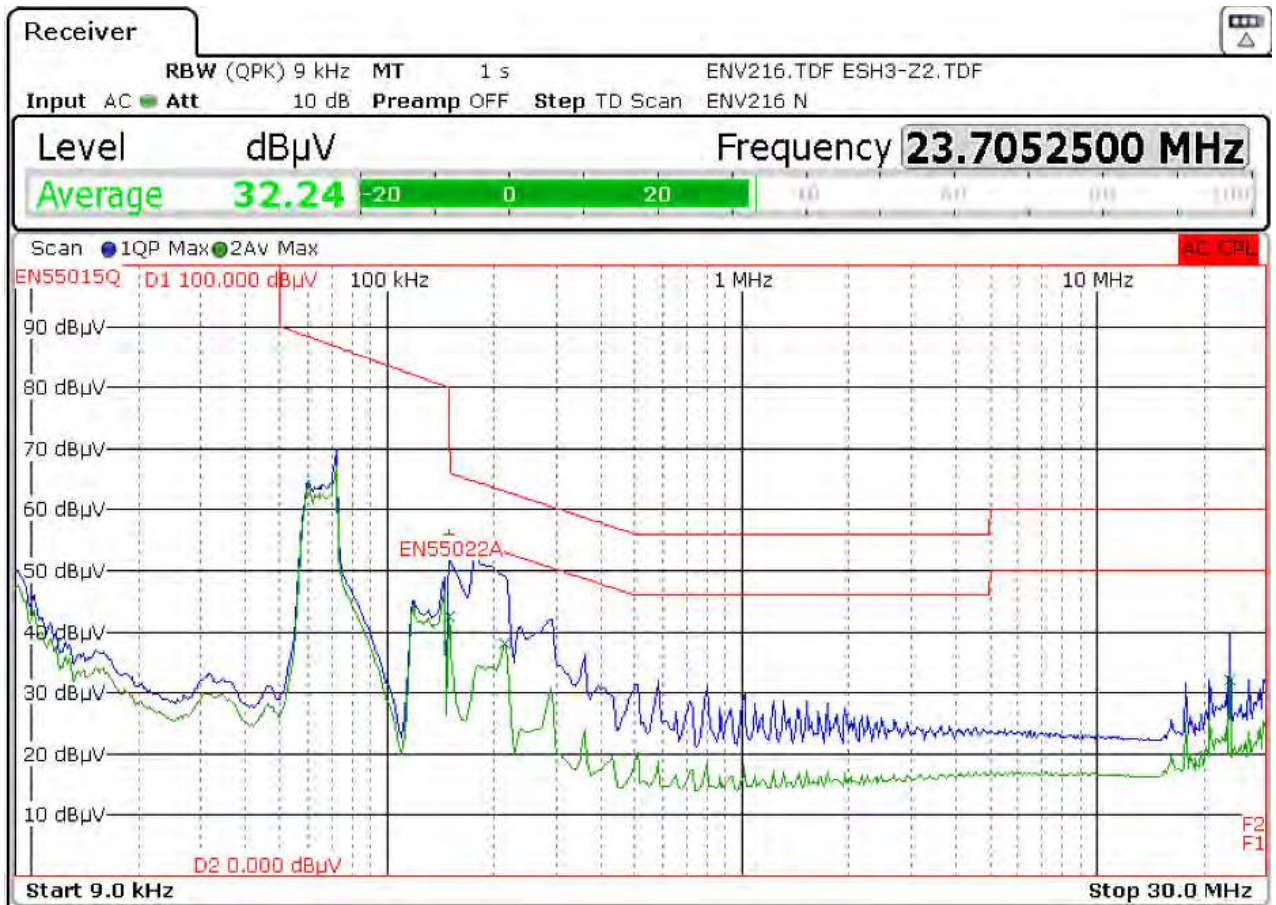

Figure 112 – Conducted EMI QP Scan at 48 V LED Load, 115 VAC, 60 Hz, and EN55015 B Limits.

Trace/Detector	Frequency	Level dBµV	DeltaLimit
1 Quasi Peak	150.0000 kHz	55.92 N	-10.08 dB
2 Average	150.0000 kHz	42.47 N	-13.53 dB
1 Quasi Peak	177.0000 kHz	52.54 L1	-12.09 dB
2 Average	215.2500 kHz	38.16 N	-14.84 dB
2 Average	23.7053 MHz	32.20 N	-17.80 dB

Figure 113 – Conducted EMI Data at 115 VAC, 48 V LED Load.

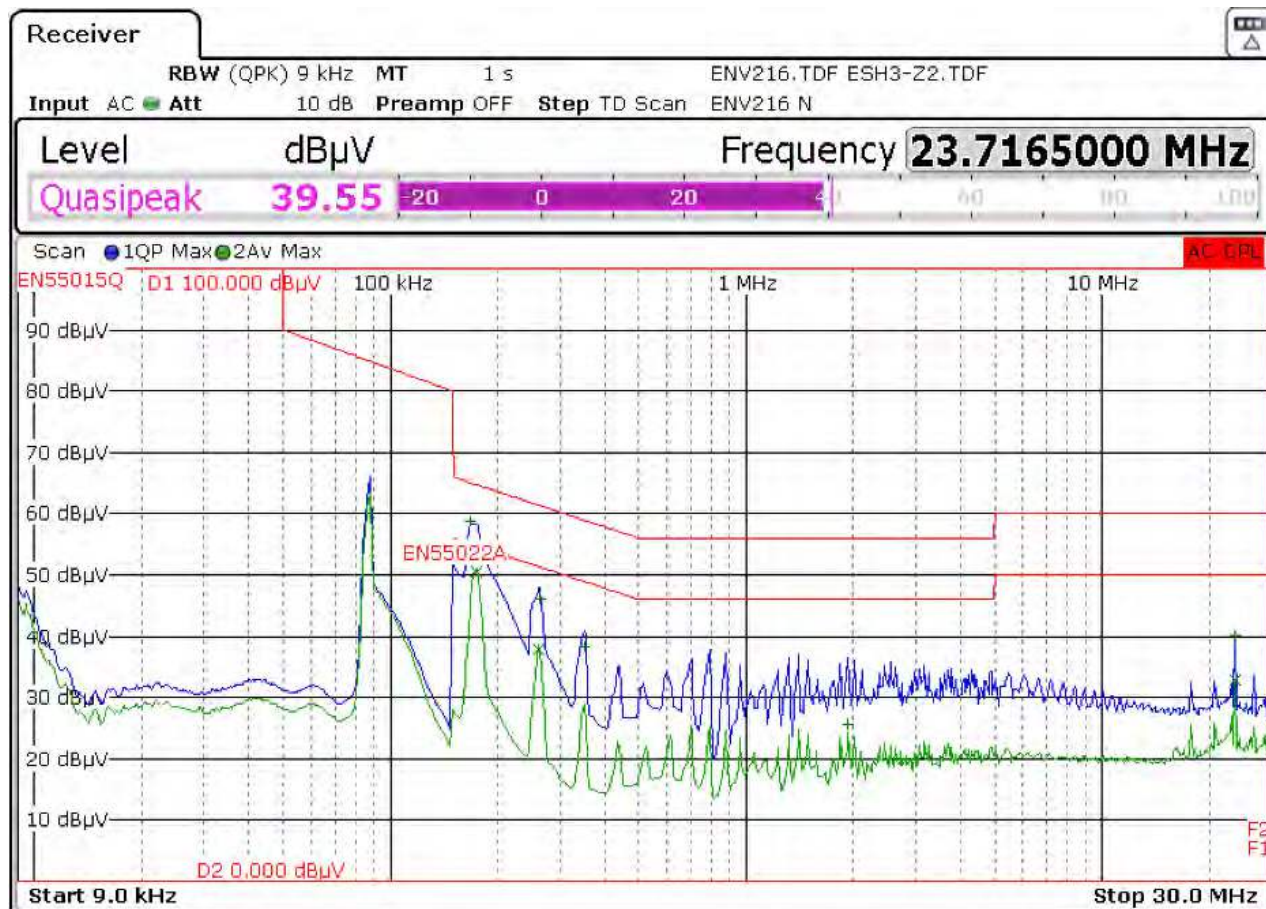

Figure 114 – Conducted EMI QP Scan at 48 V LED Load, 230 VAC, 50 Hz, and EN55015 B Limits.

Trace/Detector	Frequency	Level dBµV	DeltaLimit
1 Quasi Peak	168.0000 kHz	58.77 N	-6.29 dB
2 Average	174.7500 kHz	50.58 L1	-4.15 dB
2 Average	262.5000 kHz	37.71 L1	-13.64 dB
1 Quasi Peak	264.7500 kHz	46.08 L1	-15.20 dB
1 Quasi Peak	352.5000 kHz	38.42 N	-20.48 dB
1 Quasi Peak	1.9343 MHz	25.61 L1	-30.39 dB
2 Average	23.7075 MHz	32.92 N	-17.08 dB
1 Quasi Peak	23.7165 MHz	40.26 N	-19.74 dB

Figure 115 – Conducted EMI Data at 230 VAC, 48 V LED Load.

15 Line Surge

The unit was subjected to ± 2500 V, 100 kHz ring wave and ± 500 V differential surge using 10 strikes at each condition. A test failure was defined as a non-recoverable interruption of output requiring repair or recycling of input voltage.

Surge Level (V)	Input Voltage (VAC)	Injection Location	Injection Phase ($^{\circ}$)	Test Result (Pass/ Fail)
+500	240	L to N	0	Pass
-500	240	L to N	0	Pass
+500	240	L to N	90	Pass
-500	240	L to N	90	Pass

Surge Level (V)	Input Voltage (VAC)	Injection Location	Injection Phase ($^{\circ}$)	Test Result (Pass/ Fail)
+2500	240	L to N	0	Pass
-2500	240	L to N	0	Pass
+2500	240	L to N	90	Pass
-2500	240	L to N	90	Pass

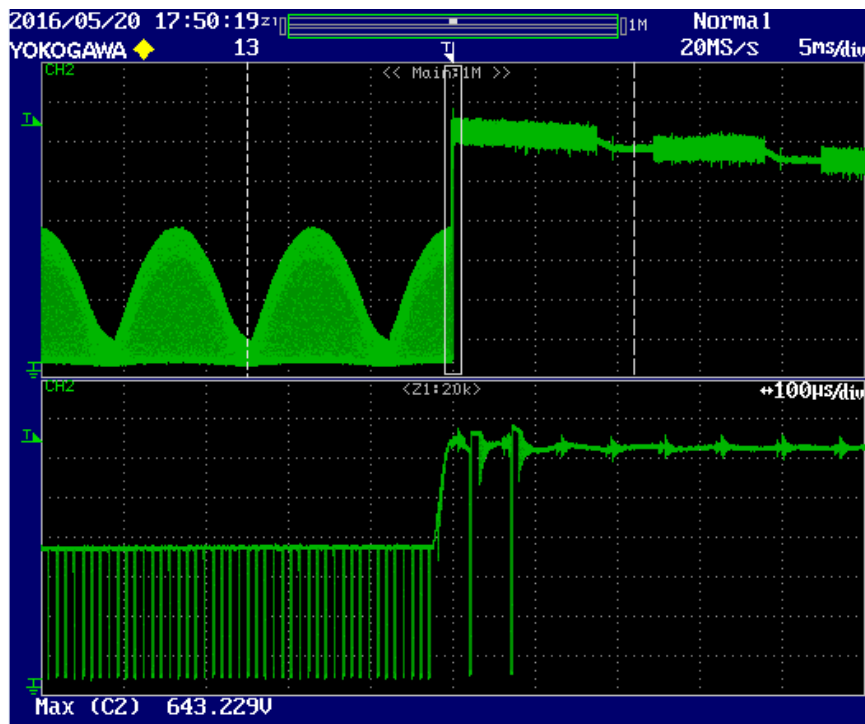

Figure 116 – +500 V Differential Surge, 90 $^{\circ}$ Phase Angle.
 V_{DRAIN} , 100 V / div., 5 m / div.
 Peak V_{DRAIN} : 643.2 V.



16 Brown-in / Brown-out Test

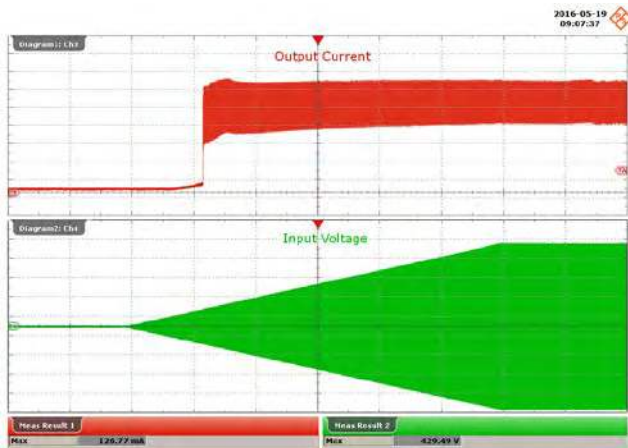

Figure 117 – Brown-in Test at 1 V / s.
 Ch1: I_{OUT} , 20 mA / div.
 Ch2: V_{IN} , 100 V / div.
 Time Scale: 50 s / div.



Figure 118 – Brown-out Test at 1 V / s.
 Ch1: I_{OUT} , 20 mA / div.
 Ch2: V_{IN} , 100 V / div.
 Time Scale: 50 s / div.

17 Revision History

Date	Author	Revision	Description and Changes	Reviewed
04-Aug-16	IB	1.0	Initial release	Apps & Mktg



For the latest updates, visit our website: www.power.com

Power Integrations reserves the right to make changes to its products at any time to improve reliability or manufacturability. Power Integrations does not assume any liability arising from the use of any device or circuit described herein. POWER INTEGRATIONS MAKES NO WARRANTY HEREIN AND SPECIFICALLY DISCLAIMS ALL WARRANTIES INCLUDING, WITHOUT LIMITATION, THE IMPLIED WARRANTIES OF MERCHANTABILITY, FITNESS FOR A PARTICULAR PURPOSE, AND NON-INFRINGEMENT OF THIRD PARTY RIGHTS.

Patent Information

The products and applications illustrated herein (including transformer construction and circuits' external to the products) may be covered by one or more U.S. and foreign patents, or potentially by pending U.S. and foreign patent applications assigned to Power Integrations. A complete list of Power Integrations' patents may be found at www.power.com. Power Integrations grants its customers a license under certain patent rights as set forth at <http://www.power.com/ip.htm>.

The PI Logo, TOPSwitch, TinySwitch, LinkSwitch, LYTSwitch, InnoSwitch, DPA-Switch, PeakSwitch, CAPZero, SENZero, LinkZero, HiperPFS, HiperTFS, HiperLCS, Qspeed, EcoSmart, Clampless, E-Shield, Filterfuse, FluxLink, StackFET, PI Expert and PI FACTS are trademarks of Power Integrations, Inc. Other trademarks are property of their respective companies. ©Copyright 2015 Power Integrations, Inc.

Power Integrations Worldwide Sales Support Locations

WORLD HEADQUARTERS

5245 Hellyer Avenue
San Jose, CA 95138, USA.
Main: +1-408-414-9200
Customer Service:
Phone: +1-408-414-9665
Fax: +1-408-414-9765
e-mail: usasales@power.com

GERMANY

Lindwurmstrasse 114
80337, Munich
Germany
Phone: +49-895-527-39110
Fax: +49-895-527-39200
e-mail: eurosales@power.com

JAPAN

Kosei Dai-3 Building
2-12-11, Shin-Yokohama,
Kohoku-ku, Yokohama-shi,
Kanagawa 222-0033
Japan
Phone: +81-45-471-1021
Fax: +81-45-471-3717
e-mail: japansales@power.com

TAI WAN

5F, No. 318, Nei Hu Rd.,
Sec. 1
Nei Hu District
Taipei 11493, Taiwan R.O.C.
Phone: +886-2-2659-4570
Fax: +886-2-2659-4550
e-mail: taiwansales@power.com

CHINA (SHANGHAI)

Rm 2410, Charity Plaza, No. 88,
North Caoxi Road,
Shanghai, PRC 200030
Phone: +86-21-6354-6323
Fax: +86-21-6354-6325
e-mail: chinasales@power.com

INDIA

#1, 14th Main Road
Vasanthanagar
Bangalore-560052
India
Phone: +91-80-4113-8020
Fax: +91-80-4113-8023
e-mail: indiasales@power.com

KOREA

RM 602, 6FL
Korea City Air Terminal B/D,
159-6
Samsung-Dong, Kangnam-Gu,
Seoul, 135-728 Korea
Phone: +82-2-2016-6610
Fax: +82-2-2016-6630
e-mail: koreasales@power.com

UK

Cambridge Semiconductor,
a Power Integrations company
Westbrook Centre, Block 5,
2nd Floor
Milton Road
Cambridge CB4 1YG
Phone: +44 (0) 1223-446483
e-mail: eurosales@power.com

CHINA (SHENZHEN)

17/F, Hivac Building, No. 2, Keji
Nan 8th Road, Nanshan District,
Shenzhen, China, 518057
Phone: +86-755-8672-8689
Fax: +86-755-8672-8690
e-mail: chinasales@power.com

ITALY

Via Milanese 20, 3rd. Fl.
20099 Sesto San Giovanni (MI)
Italy
Phone: +39-024-550-8701
Fax: +39-028-928-6009
e-mail: eurosales@power.com

SINGAPORE

51 Newton Road,
#19-01/05 Goldhill Plaza
Singapore, 308900
Phone: +65-6358-2160
Fax: +65-6358-2015
e-mail: singaporesales@power.com

