

# DIPLEXERS FOR CABLE MODEMS, SET TOP BOXES & HFC EQUIPMENT



- Small surface mount component
- 42/54 frequency split<sup>1</sup>
- Good isolation port to port
- No tuning required
- 75Ω Impedance

Electrical Specifications @ 25°C — Operating Temperature -40°C to +85°C									
Part Number	Low Pass Filter			High Pass Filter				Isolation (Port to Port)	
	Passband (Insertion Loss)		Return Loss	Passband (Insertion Loss)		Return Loss		@ 5-42 MHz	@ 54-864 MHz
	@ 5-38 MHz	@ 42 MHz	@ 5-42 MHz	@ 54 MHz	@ 80-864 MHz	@ 54-200 MHz	@ 200-864 MHz		
CX6020NL	<1dB <sup>2</sup>	<1.5dB	≥14dB	<2dB	<1dB	≥12dB	≥9dB	50 dB MIN	30 dB MIN

**NOTES:**

1. Additional frequencies are supported on request. Contact Pulse Applications Engineering.
2. Including ripple.

## Mechanical

## Schematic

### CX6020NL

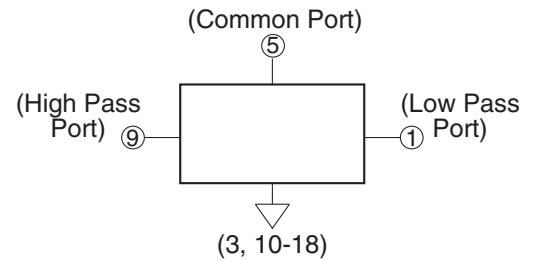
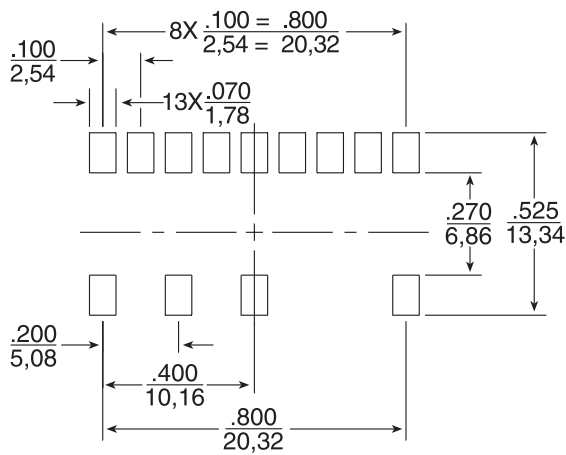
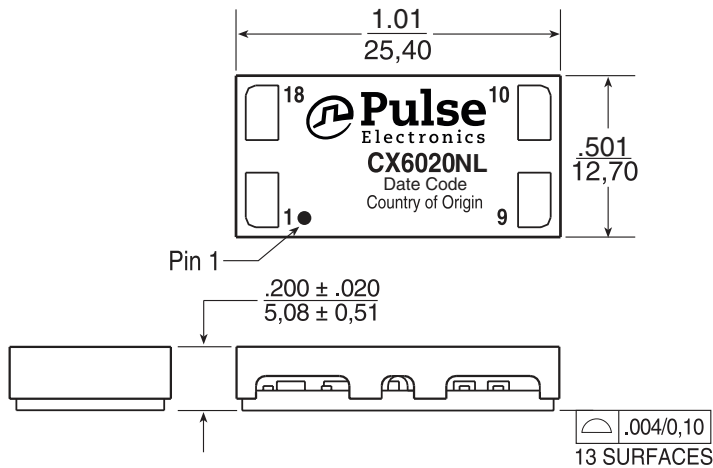

Weight ..... 3.5 grams  
Tape & Reel ..... 500/reel  
Tube ..... .20/tube

Dimensions:  $\frac{\text{Inches}}{\text{mm}}$   
Unless otherwise specified,  
all tolerances are  $\pm \frac{.010}{0,25}$

# DIPLEXERS FOR CABLE MODEMS, SET TOP BOXES & HFC EQUIPMENT

Typical Performance @ 25°C  
CX6020NL

**Low Pass Insertion Loss (TYP)**

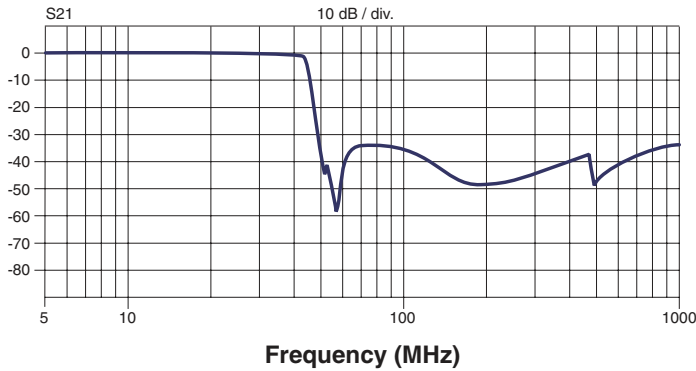

**High Pass Insertion Loss (TYP)**

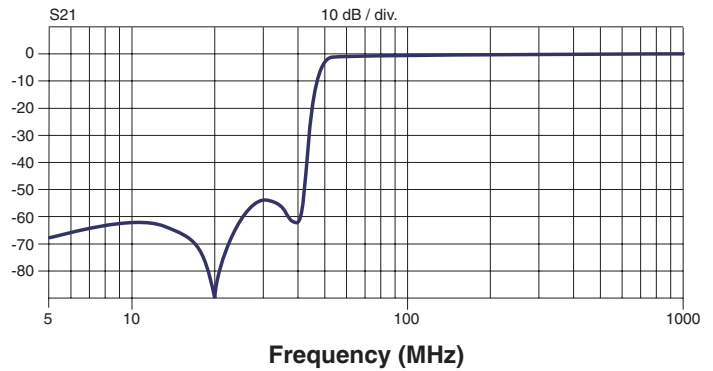

**Isolation (TYP)**

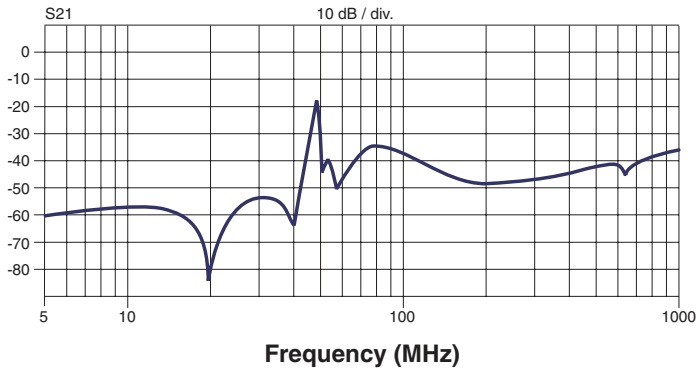

**Passband Return Loss (TYP)**

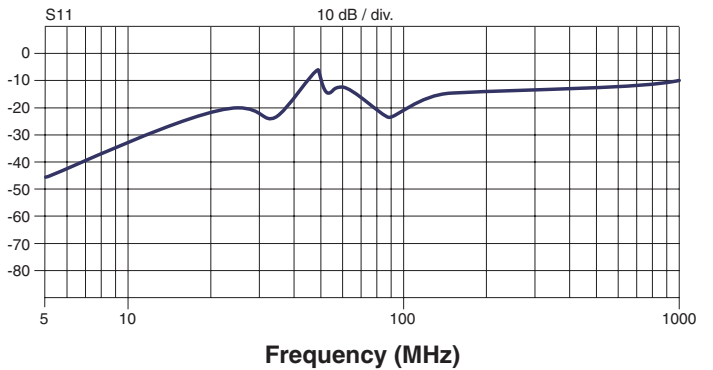

## For More Information

**Pulse Worldwide  
Headquarters**

12220 World Trade Drive  
San Diego, CA 92128  
U.S.A.

Tel: 858 674 8100  
Fax: 858 674 8262

**Pulse Europe**

Einsteinstrasse 1  
D-71083 Herrenberg  
Germany

Tel: 49 7032 7806 0  
Fax: 49 7032 7806 135

**Pulse China Headquarters**

B402, Shenzhen Academy of  
Aerospace Technology Bldg.  
10th Kejinan Road  
High-Tech Zone  
Nanshan District  
Shenzhen, PR China 518057  
Tel: 86 755 33966678  
Fax: 86 755 33966700

**Pulse North China**

Room 2704/2705  
Super Ocean Finance Ctr.  
2067 Yan An Road West  
Shanghai 200336  
China

Tel: 86 21 62787060  
Fax: 86 2162786973

**Pulse South Asia**

135 Joo Seng Road  
#03-02  
PM Industrial Bldg.  
Singapore 368363

Tel: 65 6287 8998  
Fax: 65 6287 8998

**Pulse North Asia**

3F, No. 198  
Zhongyuan Road  
Zhongli City  
Taoyuan County 320  
Taiwan R. O. C.

Tel: 886 3 4356768  
Fax: 886 3 4356823 (Pulse)  
Fax: 886 3 4356820 (FRE)

Performance warranty of products offered on this data sheet is limited to the parameters specified. Data is subject to change without notice. Other brand and product names mentioned herein may be trademarks or registered trademarks of their respective owners. © Copyright, 2011. Pulse Electronics, Inc. All rights reserved.