

RECOMMENDED PCB LAYOUT

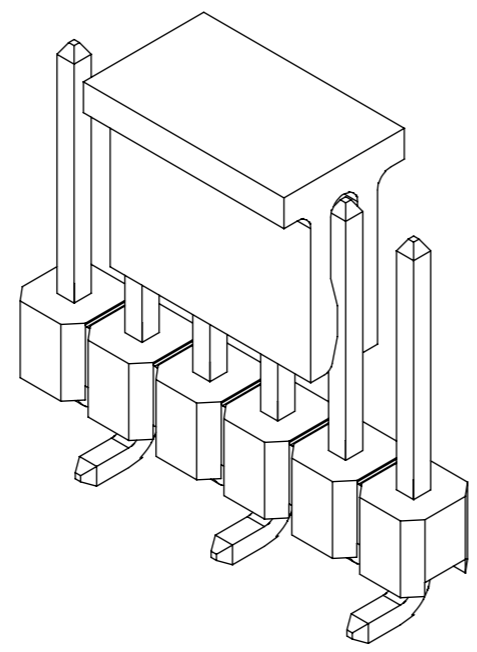
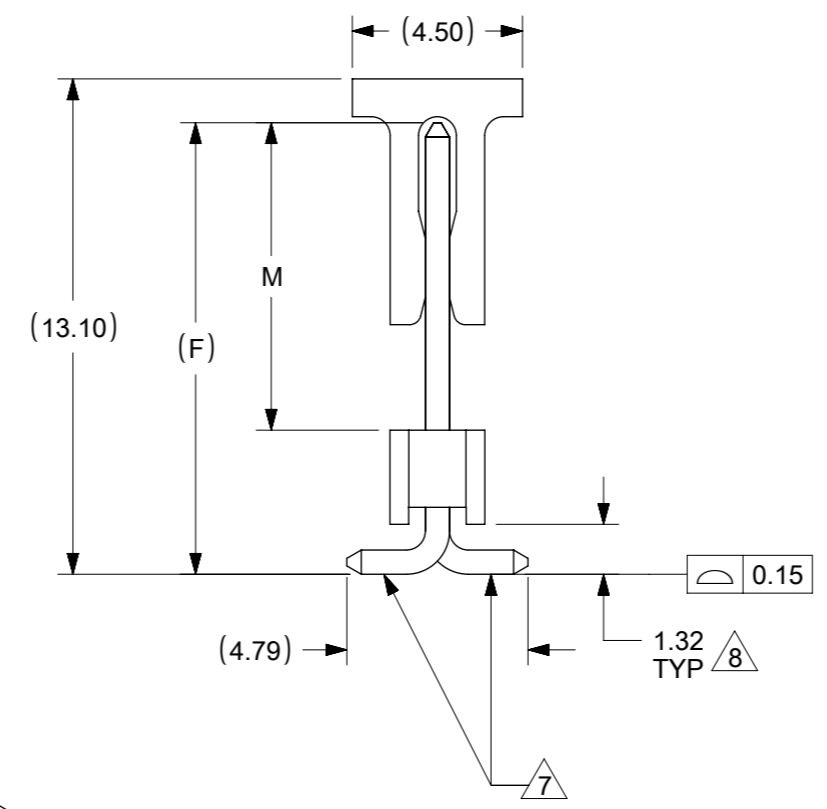
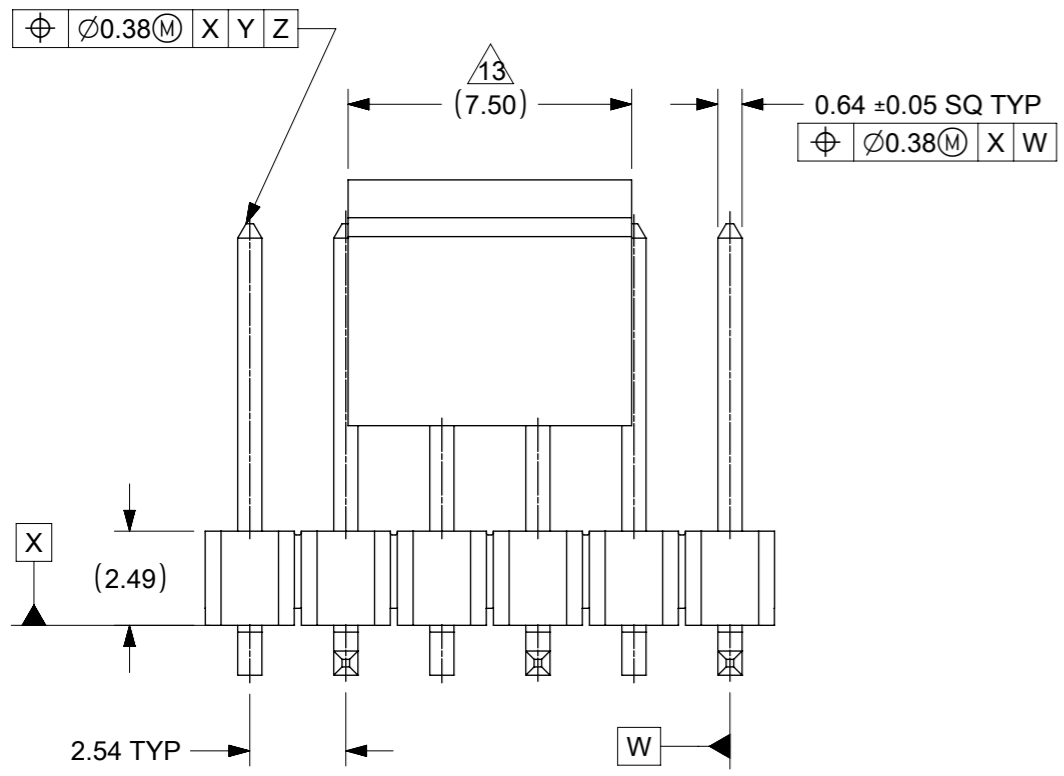

NOTES:

1. MATERIAL:
HSG: NYLON, GLASS-FILLED, UL94V-0, COLOR: BLACK
PIN: 0.64MM SQ, COPPER ALLOY
2. PLATING TYPE:
 - (1) GOLD FLASH OVER
1.25µm MIN. NICKEL OVERALL.
 - (2) GOLD FLASH ON CONTACT AND
2.50µm MIN. TIN ON SOLDER TAIL OVER
1.25µm MIN. NICKEL OVERALL.
 - (4) 0.38µm MIN. GOLD PLATE ON CONTACT AND
2.00µm MIN. TIN ON SOLDER TAIL OVER
1.25µm MIN. NICKEL OVERALL.
 - (5) 0.75µm MIN. GOLD PLATE ON CONTACT AND
2.00µm MIN. TIN ON SOLDER TAIL OVER
1.25µm MIN. NICKEL OVERALL.
 - (6) 2.50µm MIN. TIN OVERALL
1.25µm MIN. NICKEL OVERALL
3. PRODUCT SPECIFICATION: PS-87920-019
4. PACKAGING TYPE: SEE TABLE
5. PACKAGING SPEC: PK-89990-545(TUBE), PK-89990-486(T&R) & PK-87898-400 (T&R)
6. WAFER TO BE FLAT WITHIN 0.003 mm/mm
7. BEND DEPRESSION IS ACCEPTED SO LONG AS IT DOES NOT AFFECT THE OVERALL COPLANARITY OF TAIL
8. COPLANARITY IS TO BE MEASURED BY RESTING THE SOLDER TAIL ON A FLAT SURFACE
9. IRREGULAR CIRCUIT CUTOFF WITHIN BREAKAWAY SECTION IS PERMISSIBLE. CUTTING OR CHIPPING OF THE MAIN BODY IS NOT ACCEPTABLE
10. TUBE LENGTH AS PER STANDARD 560mm
11. RECOMMENDED PCB THICKNESS IS 1.60mm±0.10
12. THE ABOVE CKT 6 IS FOR ILLUSTRATION PURPOSE ONLY
13. CAP LOCATION IS CENTERED ALONG THE MATING ENDS AS SHOWN. TOP SURFACE OF CAP TO BE FLAT FOR THE PURPOSE OF PICK & PLACE BY VACUUM SUCTION NOZZLE.

THIS DRAWING CONTAINS INFORMATION THAT IS PROPRIETARY TO MOLEX ELECTRONIC TECHNOLOGIES, LLC AND SHOULD NOT BE USED WITHOUT WRITTEN PERMISSION											
DIMENSION UNITS		SCALE		CURRENT REV DESC:						molex	
mm		NTS									
GENERAL TOLERANCES (UNLESS SPECIFIED)				EC NO: 698212		DRWN: DANUSA		2022/03/03		CUSTOM HEADER	
				CHK'D: DANUSA		2022/03/04		2.54MM PITCH SINGLE ROW SINGLE WAFER SMT		HEADER	
4 PLACES ±				APPR: MRAMAKRISHNA		2022/03/04		PRODUCT CUSTOMER DRAWING			
3 PLACES ±				INITIAL REVISION:		DRWN: SKLIM01		2005/10/26		DOCUMENT NUMBER	
2 PLACES ± 0.2				APPR: PTLIM		2005/11/07		SD-87898-003		DOC TYPE DOC PART REVISION	
1 PLACE ±				DRAFT WHERE APPLICABLE MUST REMAIN WITHIN DIMENSIONS		THIRD ANGLE PROJECTION		DRAWING		SERIES	
0 PLACES ±				A3-SIZE		87898		MATERIAL NUMBER		CUSTOMER	
ANGULAR TOL ± 3.0°				SEE TABLE		GENERAL MARKET		SHEET NUMBER		1 OF 17	

9 8 7 6 5 4 3 2 1

E
D
C
B
A

PART WITHOUT CAP
IN TUBE
ORIENTATION

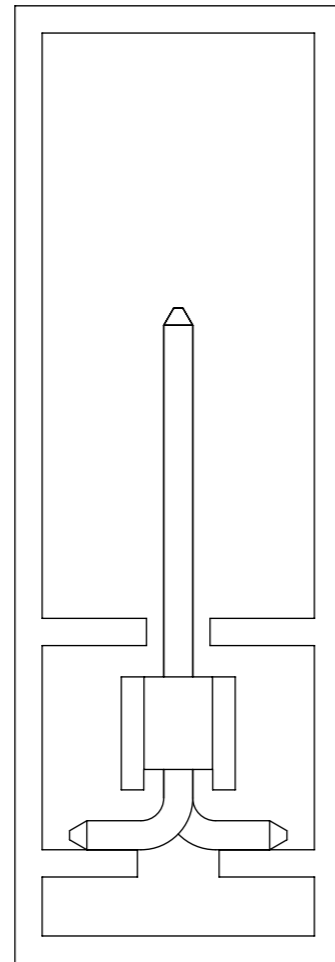

PART WITH CAP
IN TUBE
ORIENTATION

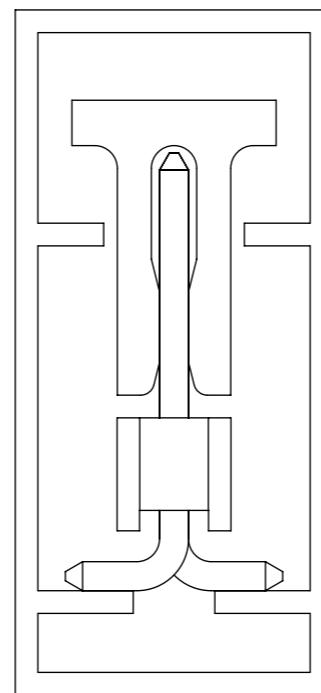

THIS DRAWING CONTAINS INFORMATION THAT IS PROPRIETARY TO MOLEX ELECTRONIC TECHNOLOGIES, LLC AND SHOULD NOT BE USED WITHOUT WRITTEN PERMISSION									
DIMENSION UNITS		SCALE		CURRENT REV DESC:				molex	
mm		NTS							
GENERAL TOLERANCES (UNLESS SPECIFIED)				EC NO: 698212				CUSTOM HEADER	
				DRWN: DANUSA 2022/03/03				2.54MM PITCH SINGLE ROW SINGLE WAFER SMT	
				CHK'D: DANUSA 2022/03/04				HEADER	
				APPR: MRAMAKRISHNA 2022/03/04				PRODUCT CUSTOMER DRAWING	
4 PLACES ±				INITIAL REVISION:				DOCUMENT NUMBER	
3 PLACES ±				DRWN: SKLIM01 2005/10/26				SD-87898-003	
2 PLACES ± 0.2				APPR: PTLIM 2005/11/07				DOC TYPE	
1 PLACE ±								PSD	
0 PLACES ±								DOC PART	
ANGULAR TOL ± 3.0°								001	
DRAFT WHERE APPLICABLE MUST REMAIN WITHIN DIMENSIONS				THIRD ANGLE PROJECTION		DRAWING		SERIES	
				A3-SIZE		87898		MATERIAL NUMBER	
				SEE TABLE		CUSTOMER		SHEET NUMBER	
				GENERAL MARKET		2 OF 17			

DOCUMENT STATUS	P1	RELEASE DATE	2022/03/04	09:00:56
-----------------	----	--------------	------------	----------

9 8 7 6 5 4 3 2 1

FORMAT: Mef-lega-master-ib-prod-A3
REVISION: D
DATE: 2018/01/18

CKT	DIMENSION						QTY/REEL
	Bo	Ao	Ko	F	So	W	
3	8.02	5.20	13.60	11.50	--	24.00	320
4	10.51	5.79	15.05	14.20	28.40	32.00	250
5	13.10	5.20	13.60	11.50	---	24.00	320

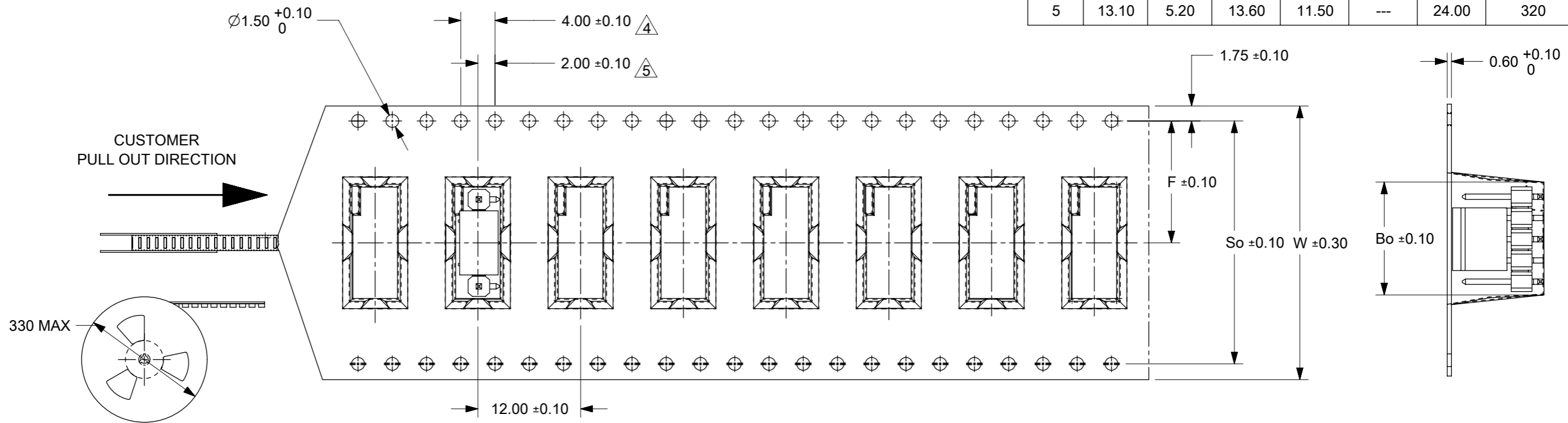

NOTES:

1. LEADER AND TRAILER TAPE

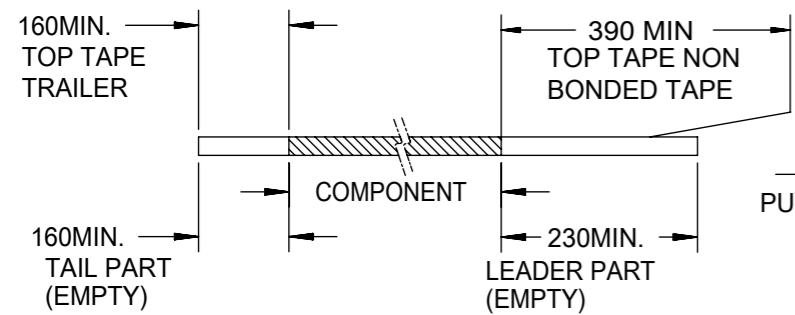

2. PEELING OFF FORCE OF THE TOP TAPE: 20 - 80gf. (PEELING DIRECTION AS SHOWN IN FOLLOWING FIGURE)

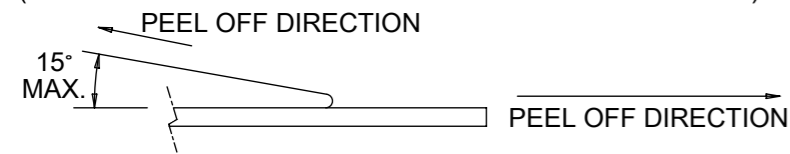

- 3. MATERIAL: BLACK P.S CONDUCTIVE, BLACK
- 4. MEASURED FROM CENTRELINE OF SPROCKET HOLE TO CENTRELINE OF POCKET
- 5. CUMULATIVE TOLERANCE OF 10 SPROCKET HOLE IS $\pm 0.20\text{mm}$
- 6. A0 AND B0 ARE MEASURE FROM ABOVE POCKET BASE 0.30mm
- 7. TAPE AND REEL SPECIFICATION IS AS PER EIA-481.
- 8. THE TAPE IS TREATED FOR ANTI-STATIC.
- 9. ALL RADIUS ARE 0.30MM UNLESS SPECIFY
- 10. SURFACE RESISTIVITY 10^3 TO 10 OHMS.

THIS DRAWING CONTAINS INFORMATION THAT IS PROPRIETARY TO MOLEX ELECTRONIC TECHNOLOGIES, LLC AND SHOULD NOT BE USED WITHOUT WRITTEN PERMISSION

DIMENSION UNITS	SCALE	CURRENT REV DESC:		molex	
mm	NTS				
GENERAL TOLERANCES (UNLESS SPECIFIED)		EC NO: 698212		CUSTOMER	
		DRWN: DANUSA 2022/03/03		2.54MM PITCH SINGLE ROW SINGLE WAFER SMT HEADER	
		CHK'D: DANUSA 2022/03/04		PRODUCT CUSTOMER DRAWING	
		APPR: MRAMAKRISHNA 2022/03/04			
		INITIAL REVISION:		DOCUMENT NUMBER	
		DRWN: SKLIM01 2005/10/26		SD-87898-003	
		APPR: PTLIM 2005/11/07		DOC TYPE DOC PART REVISION	
				PSD 001 C1	
DRAFT WHERE APPLICABLE MUST REMAIN WITHIN DIMENSIONS		THIRD ANGLE PROJECTION	DRAWING	SERIES	MATERIAL NUMBER
			A3-SIZE	87898	SEE TABLE
		CUSTOMER		SHEET NUMBER	
		GENERAL MARKET		3 OF 17	

9 8 7 6 5 4 3 2 1

PACKAGING OPTION PART NO.						CKT SIZE	VOID POSITION	PLATING TYPE	DIMENSION			
TRAY WITHOUT CAP	TRAY WITH CAP	TUBE WITHOUT CAP	TUBE WITH CAP	TAPE & REEL WITHOUT CAP	TAPE & REEL WITH CAP				A	B	F	M
-----	(C) 87898-0361	-----	-----	-----	-----	3	----	1	7.62	5.08	11.94	8.13
-----	(C) 87898-0362	-----	-----	-----	-----	3	----	2	7.62	5.08	11.94	8.13
-----	(C) 87898-0364	-----	-----	-----	87898-0369	3	----	4	7.62	5.08	11.94	8.13
-----	(C) 87898-0365	-----	-----	-----	-----	3	----	5	7.62	5.08	11.94	8.13
-----	(C) 87898-0366	-----	87898-0367	-----	87898-0368	3	----	6	7.62	5.08	11.94	8.13

E

E

D

D

C

C

B

B

A

A

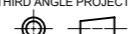
THIS DRAWING CONTAINS INFORMATION THAT IS PROPRIETARY TO MOLEX ELECTRONIC TECHNOLOGIES, LLC AND SHOULD NOT BE USED WITHOUT WRITTEN PERMISSION											
DIMENSION UNITS		SCALE		CURRENT REV DESC:							
mm		NTS									
GENERAL TOLERANCES (UNLESS SPECIFIED)				EC NO: 698212 DRWN: DANUSA 2022/03/03 CHK'D: DANUSA 2022/03/04 APPR: MRAMAKRISHNA 2022/03/04 INITIAL REVISION: DRWN: SKLIM01 2005/10/26 APPR: PTLIM 2005/11/07				CUSTOMER DRAWING			
								2.54MM PITCH SINGLE ROW SINGLE WAFER SMT HEADER			
4 PLACES ±		±						PRODUCT CUSTOMER DRAWING			
3 PLACES ±		±						DOCUMENT NUMBER			
2 PLACES ±		0.2 ±						SD-87898-003			
1 PLACE ±		±		DOC TYPE							
0 PLACES ±		±		PSD							
ANGULAR TOL ±		3.0°		DOC PART							
				001							
DRAFT WHERE APPLICABLE MUST REMAIN WITHIN DIMENSIONS		THIRD ANGLE PROJECTION		REVISION							
				C1							
		DRAWING		SHEET NUMBER							
		A3-SIZE		4 OF 17							
		SERIES		CUSTOMER							
		87898		GENERAL MARKET							
		MATERIAL NUMBER		SEE TABLE							

DOCUMENT STATUS	P1	RELEASE DATE	2022/03/04	09:00:56
-----------------	----	--------------	------------	----------

9 8 7 6 5 4 3 2 1

FORMAT: Mel-lega-master-ib-prod-A3
 REVISION: D
 DATE: 2018/01/18

PACKAGING OPTION PART NO.						CKT SIZE	PEG	VOID POSITION	PLATING TYPE	DIMENSION			
TRAY WITHOUT CAP	TRAY WITH CAP	TUBE WITHOUT CAP	TUBE WITH CAP	TAPE & REEL WITHOUT CAP	TAPE & REEL WITH CAP					A	B	F	M
-----	-----	87898-0461	-----	-----	-----	4	---	----	1	10.16	7.62	11.94	8.13
-----	-----	87898-0462	-----	-----	-----	4	---	----	2	10.16	7.62	11.94	8.13
-----	-----	87898-0464	-----	-----	-----	4	---	----	4	10.16	7.62	11.94	8.13
-----	-----	87898-0465	-----	-----	-----	4	---	----	5	10.16	7.62	11.94	8.13
-----	-----	87898-0466	-----	-----	87898-0467	4	---	----	6	10.16	7.62	11.94	8.13
-----	-----	-----	-----	-----	87898-0468	4	Y	----	6	10.16	7.62	11.94	8.13
-----	-----	-----	-----	87898-0489	-----	4	Y	----	5	10.16	7.62	16.74	12.93
-----	-----	87898-0561	-----	-----	-----	5	---	----	1	12.70	10.16	11.94	8.13
-----	-----	87898-0562	-----	-----	-----	5	---	----	2	12.70	10.16	11.94	8.13
-----	-----	87898-0564	-----	-----	-----	5	---	----	4	12.70	10.16	11.94	8.13
-----	-----	87898-0565	-----	-----	-----	5	---	----	5	12.70	10.16	11.94	8.13
-----	-----	87898-0566	87898-0567	-----	87898-0568	5	---	----	6	12.70	10.16	11.94	8.13
-----	-----	87898-0661	-----	-----	-----	6	---	----	1	15.24	12.70	11.94	8.13
-----	-----	87898-0662	-----	-----	-----	6	---	----	2	15.24	12.70	11.94	8.13
-----	-----	87898-0664	-----	-----	-----	6	---	----	4	15.24	12.70	11.94	8.13
-----	-----	87898-0665	-----	-----	(C) -----	6	---	----	5	15.24	12.70	11.94	8.13
-----	-----	87898-0666	-----	-----	87898-0605	6	---	----	6	15.24	12.70	11.94	8.13

4 CKT WITH PEG FOR ILLUSTRATION ONLY

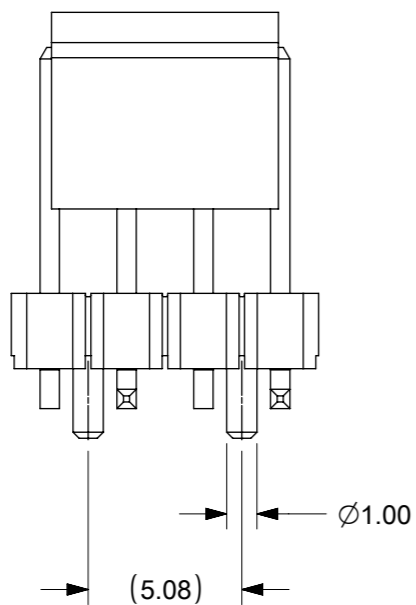

THIS DRAWING CONTAINS INFORMATION THAT IS PROPRIETARY TO MOLEX ELECTRONIC TECHNOLOGIES, LLC AND SHOULD NOT BE USED WITHOUT WRITTEN PERMISSION											
DIMENSION UNITS		SCALE		CURRENT REV DESC:							
mm		NTS									
GENERAL TOLERANCES (UNLESS SPECIFIED)				EC NO: 698212		DRWN: DANUSA		2022/03/03		CUSTOM HEADER 2.54MM PITCH SINGLE ROW SINGLE WAFER SMT HEADER	
				CHK'D: DANUSA		2022/03/04					
4 PLACES ±				APPR: MRAMAKRISHNA		2022/03/04		PRODUCT CUSTOMER DRAWING			
3 PLACES ±				INITIAL REVISION:		DRWN: SKLIM01		2005/10/26		DOCUMENT NUMBER	
2 PLACES ± 0.2				APPR: PTLIM		2005/11/07		SD-87898-003		DOC TYPE DOC PART REVISION	
1 PLACE ±				THIRD ANGLE PROJECTION		DRAWING		SERIES		MATERIAL NUMBER	
0 PLACES ±				DRAFT WHERE APPLICABLE MUST REMAIN WITHIN DIMENSIONS		A3-SIZE		87898		CUSTOMER	
ANGULAR TOL ± 3.0°								SEE TABLE		GENERAL MARKET	
SHEET NUMBER				5 OF 17							

PACKAGING OPTION PART NO.						CKT SIZE	VOID POSITION	PLATING TYPE	DIMENSION			
TRAY WITHOUT CAP	TRAY WITH CAP	TUBE WITHOUT CAP	TUBE WITH CAP	TAPE & REEL WITHOUT CAP	TAPE & REEL WITH CAP				A	B	F	M
-----	-----	87898-0761	-----	-----	-----	7	----	1	17.78	15.24	11.94	8.13
-----	-----	87898-0762	-----	-----	-----	7	----	2	17.78	15.24	11.94	8.13
-----	-----	87898-0764	-----	-----	-----	7	----	4	17.78	15.24	11.94	8.13
-----	-----	87898-0765	-----	-----	-----	7	----	5	17.78	15.24	11.94	8.13
-----	-----	87898-0766	-----	-----	-----	7	----	6	17.78	15.24	11.94	8.13
-----	-----	87898-0861	-----	-----	-----	8	----	1	20.32	17.78	11.94	8.13
-----	-----	87898-0862	-----	-----	-----	8	----	2	20.32	17.78	11.94	8.13
-----	-----	87898-0864	-----	-----	-----	8	----	4	20.32	17.78	11.94	8.13
-----	-----	87898-0865	-----	-----	-----	8	----	5	20.32	17.78	11.94	8.13
-----	-----	87898-0866	-----	-----	-----	8	----	6	20.32	17.78	11.94	8.13
-----	-----	87898-0961	-----	-----	-----	9	----	1	22.86	20.32	11.94	8.13
-----	-----	87898-0962	-----	-----	-----	9	----	2	22.86	20.32	11.94	8.13
-----	-----	87898-0964	-----	-----	-----	9	----	4	22.86	20.32	11.94	8.13
-----	-----	87898-0965	-----	-----	-----	9	----	5	22.86	20.32	11.94	8.13
-----	-----	87898-0966	-----	-----	-----	9	----	6	22.86	20.32	11.94	8.13

THIS DRAWING CONTAINS INFORMATION THAT IS PROPRIETARY TO MOLEX ELECTRONIC TECHNOLOGIES, LLC AND SHOULD NOT BE USED WITHOUT WRITTEN PERMISSION

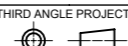
DIMENSION UNITS		SCALE		CURRENT REV DESC:								
mm		NTS										
GENERAL TOLERANCES (UNLESS SPECIFIED)				EC NO: 698212 DRWN: DANUSA 2022/03/03 CHK'D: DANUSA 2022/03/04 APPR: MRAMAKRISHNA 2022/03/04 INITIAL REVISION: DRWN: SKLIM01 2005/10/26 APPR: PTLIM 2005/11/07				CUSTOMER				
								2.54MM PITCH SINGLE ROW SINGLE WAFER SMT HEADER				
								PRODUCT CUSTOMER DRAWING				
								DOCUMENT NUMBER		DOC TYPE	DOC PART	REVISION
								SD-87898-003		PSD	001	C1
								MATERIAL NUMBER		CUSTOMER		SHEET NUMBER
DRAFT WHERE APPLICABLE MUST REMAIN WITHIN DIMENSIONS				THIRD ANGLE PROJECTION		DRAWING	SERIES					
						A3-SIZE	87898	SEE TABLE	GENERAL MARKET	6 OF 17		

PACKAGING OPTION PART NO.						CKT SIZE	VOID POSITION	PLATING TYPE	DIMENSION			
TRAY WITHOUT CAP	TRAY WITH CAP	TUBE WITHOUT CAP	TUBE WITH CAP	TAPE & REEL WITHOUT CAP	TAPE & REEL WITH CAP				A	B	F	M
-----	-----	87898-1061	-----	-----	-----	10	----	1	25.40	22.86	11.94	8.13
-----	-----	87898-1062	-----	-----	-----	10	----	2	25.40	22.86	11.94	8.13
-----	-----	87898-1064	-----	-----	-----	10	----	4	25.40	22.86	11.94	8.13
-----	-----	87898-1065	-----	-----	-----	10	----	5	25.40	22.86	11.94	8.13
-----	-----	87898-1066	-----	-----	-----	10	----	6	25.40	22.86	11.94	8.13
-----	-----	87898-1161	-----	-----	-----	11	----	1	27.94	25.40	11.94	8.13
-----	-----	87898-1162	-----	-----	-----	11	----	2	27.94	25.40	11.94	8.13
-----	-----	87898-1164	-----	-----	-----	11	----	4	27.94	25.40	11.94	8.13
-----	-----	87898-1165	-----	-----	-----	11	----	5	27.94	25.40	11.94	8.13
-----	-----	87898-1166	-----	-----	-----	11	----	6	27.94	25.40	11.94	8.13
-----	-----	87898-1261	-----	-----	-----	12	----	1	30.48	27.94	11.94	8.13
-----	-----	87898-1262	-----	-----	-----	12	----	2	30.48	27.94	11.94	8.13
-----	-----	87898-1264	-----	-----	-----	12	----	4	30.48	27.94	11.94	8.13
-----	-----	87898-1265	-----	-----	-----	12	----	5	30.48	27.94	11.94	8.13
-----	-----	87898-1266	-----	-----	-----	12	----	6	30.48	27.94	11.94	8.13

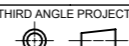
THIS DRAWING CONTAINS INFORMATION THAT IS PROPRIETARY TO MOLEX ELECTRONIC TECHNOLOGIES, LLC AND SHOULD NOT BE USED WITHOUT WRITTEN PERMISSION																					
DIMENSION UNITS		SCALE		CURRENT REV DESC:																	
mm		NTS																			
GENERAL TOLERANCES (UNLESS SPECIFIED)				EC NO: 698212 DRWN: DANUSA 2022/03/03 CHK'D: DANUSA 2022/03/04 APPR: MRAMAKRISHNA 2022/03/04						CUSTOM HEADER 2.54MM PITCH SINGLE ROW SINGLE WAFER SMT HEADER											
4 PLACES ±				INITIAL REVISION: DRWN: SKLIM01 2005/10/26 APPR: PTLIM 2005/11/07						PRODUCT CUSTOMER DRAWING											
3 PLACES ±																					
2 PLACES ± 0.2				DOCUMENT NUMBER SD-87898-003						DOC TYPE PSD		DOC PART 001		REVISION C1							
1 PLACE ±																					
0 PLACES ±				DRAFT WHERE APPLICABLE MUST REMAIN WITHIN DIMENSIONS						THIRD ANGLE PROJECTION 		DRAWING A3-SIZE		SERIES 87898		MATERIAL NUMBER SEE TABLE		CUSTOMER GENERAL MARKET		SHEET NUMBER 7 OF 17	
ANGULAR TOL ± 3.0°																					

PACKAGING OPTION PART NO.						CKT SIZE	VOID POSITION	PLATING TYPE	DIMENSION			
TRAY WITHOUT CAP	TRAY WITH CAP	TUBE WITHOUT CAP	TUBE WITH CAP	TAPE & REEL WITHOUT CAP	TAPE & REEL WITH CAP				A	B	F	M
-----	-----	87898-1361	-----	-----	-----	13	----	1	33.02	30.48	11.94	8.13
-----	-----	87898-1362	-----	-----	-----	13	----	2	33.02	30.48	11.94	8.13
-----	-----	87898-1364	-----	-----	-----	13	----	4	33.02	30.48	11.94	8.13
-----	-----	87898-1365	-----	-----	-----	13	----	5	33.02	30.48	11.94	8.13
-----	-----	87898-1366	-----	-----	-----	13	----	6	33.02	30.48	11.94	8.13
-----	-----	87898-1461	-----	-----	-----	14	----	1	35.56	33.02	11.94	8.13
-----	-----	87898-1462	-----	-----	-----	14	----	2	35.56	33.02	11.94	8.13
-----	-----	87898-1464	-----	-----	-----	14	----	4	35.56	33.02	11.94	8.13
-----	-----	87898-1465	-----	-----	-----	14	----	5	35.56	33.02	11.94	8.13
-----	-----	87898-1466	-----	-----	-----	14	----	6	35.56	33.02	11.94	8.13
-----	-----	87898-1561	-----	-----	-----	15	----	1	38.10	35.56	11.94	8.13
-----	-----	87898-1562	-----	-----	-----	15	----	2	38.10	35.56	11.94	8.13
-----	-----	87898-1564	-----	-----	-----	15	----	4	38.10	35.56	11.94	8.13
-----	-----	87898-1565	-----	-----	-----	15	----	5	38.10	35.56	11.94	8.13
-----	-----	87898-1566	-----	-----	-----	15	----	6	38.10	35.56	11.94	8.13

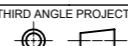
THIS DRAWING CONTAINS INFORMATION THAT IS PROPRIETARY TO MOLEX ELECTRONIC TECHNOLOGIES, LLC AND SHOULD NOT BE USED WITHOUT WRITTEN PERMISSION													
DIMENSION UNITS		SCALE		CURRENT REV DESC:									
mm		NTS											
GENERAL TOLERANCES (UNLESS SPECIFIED)				EC NO: 698212 DRWN: DANUSA 2022/03/03 CHK'D: DANUSA 2022/03/04 APPR: MRAMAKRISHNA 2022/03/04						CUSTOM HEADER 2.54MM PITCH SINGLE ROW SINGLE WAFER SMT HEADER			
		MM	INCH										
4 PLACES		±	±	INITIAL REVISION: DRWN: SKLIM01 2005/10/26 APPR: PTLIM 2005/11/07						PRODUCT CUSTOMER DRAWING DOCUMENT NUMBER: SD-87898-003 DOC TYPE: PSD DOC PART: 001 REVISION: C1			
3 PLACES		±	±										
2 PLACES		± 0.2	±	DRAFT WHERE APPLICABLE MUST REMAIN WITHIN DIMENSIONS						THIRD ANGLE PROJECTION 			
1 PLACE		±	±										
0 PLACES		±	±	DRAWING		SERIES		MATERIAL NUMBER		CUSTOMER		SHEET NUMBER	
ANGULAR TOL		± 3.0°		A3-SIZE		87898		SEE TABLE		GENERAL MARKET		8 OF 17	

PACKAGING OPTION PART NO.						CKT SIZE	VOID POSITION	PLATING TYPE	DIMENSION			
TRAY WITHOUT CAP	TRAY WITH CAP	TUBE WITHOUT CAP	TUBE WITH CAP	TAPE & REEL WITHOUT CAP	TAPE & REEL WITH CAP				A	B	F	M
-----	-----	87898-1661	-----	-----	-----	16	----	1	40.64	38.10	11.94	8.13
-----	-----	87898-1662	-----	-----	-----	16	----	2	40.64	38.10	11.94	8.13
-----	-----	87898-1664	-----	-----	-----	16	----	4	40.64	38.10	11.94	8.13
-----	-----	87898-1665	-----	-----	-----	16	----	5	40.64	38.10	11.94	8.13
-----	-----	87898-1666	-----	-----	-----	16	----	6	40.64	38.10	11.94	8.13
-----	-----	87898-1761	-----	-----	-----	17	----	1	43.18	40.64	11.94	8.13
-----	-----	87898-1762	-----	-----	-----	17	----	2	43.18	40.64	11.94	8.13
-----	-----	87898-1764	-----	-----	-----	17	----	4	43.18	40.64	11.94	8.13
-----	-----	87898-1765	-----	-----	-----	17	----	5	43.18	40.64	11.94	8.13
-----	-----	87898-1766	-----	-----	-----	17	----	6	43.18	40.64	11.94	8.13
-----	-----	87898-1861	-----	-----	-----	18	----	1	45.72	43.18	11.94	8.13
-----	-----	87898-1862	-----	-----	-----	18	----	2	45.72	43.18	11.94	8.13
-----	-----	87898-1864	-----	-----	-----	18	----	4	45.72	43.18	11.94	8.13
-----	-----	87898-1865	-----	-----	-----	18	----	5	45.72	43.18	11.94	8.13
-----	-----	87898-1866	-----	-----	-----	18	----	6	45.72	43.18	11.94	8.13

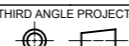
THIS DRAWING CONTAINS INFORMATION THAT IS PROPRIETARY TO MOLEX ELECTRONIC TECHNOLOGIES, LLC AND SHOULD NOT BE USED WITHOUT WRITTEN PERMISSION												
DIMENSION UNITS		SCALE		CURRENT REV DESC:								
mm		NTS										
GENERAL TOLERANCES (UNLESS SPECIFIED)				EC NO: 698212 DRWN: DANUSA 2022/03/03 CHK'D: DANUSA 2022/03/04 APPR: MRAMAKRISHNA 2022/03/04				CUSTOM HEADER 2.54MM PITCH SINGLE ROW SINGLE WAFER SMT HEADER				
		MM	INCH									
4 PLACES	±		±	INITIAL REVISION: DRWN: SKLIM01 2005/10/26 APPR: PTLIM 2005/11/07				DOCUMENT NUMBER		DOC TYPE	DOC PART	REVISION
3 PLACES	±		±					SD-87898-003		PSD	001	C1
2 PLACES	±	0.2	±	DRAFT WHERE APPLICABLE MUST REMAIN WITHIN DIMENSIONS				MATERIAL NUMBER		CUSTOMER		SHEET NUMBER
1 PLACE	±		±					SEE TABLE		GENERAL MARKET		9 OF 17
0 PLACES	±		±	THIRD ANGLE PROJECTION		DRAWING	SERIES	CUSTOMER		SHEET NUMBER		
ANGULAR TOL		± 3.0°				A3-SIZE	87898	GENERAL MARKET		9 OF 17		

PACKAGING OPTION PART NO.						CKT SIZE	VOID POSITION	PLATING TYPE	DIMENSION			
TRAY WITHOUT CAP	TRAY WITH CAP	TUBE WITHOUT CAP	TUBE WITH CAP	TAPE & REEL WITHOUT CAP	TAPE & REEL WITH CAP				A	B	F	M
-----	-----	87898-1961	-----	-----	-----	19	----	1	48.26	45.72	11.94	8.13
-----	-----	87898-1962	-----	-----	-----	19	----	2	48.26	45.72	11.94	8.13
-----	-----	87898-1964	-----	-----	-----	19	----	4	48.26	45.72	11.94	8.13
-----	-----	87898-1965	-----	-----	-----	19	----	5	48.26	45.72	11.94	8.13
-----	-----	87898-1966	-----	-----	-----	19	----	6	48.26	45.72	11.94	8.13
-----	-----	87898-2061	-----	-----	-----	20	----	1	50.80	48.26	11.94	8.13
-----	-----	87898-2062	-----	-----	-----	20	----	2	50.80	48.26	11.94	8.13
-----	-----	87898-2064	-----	-----	-----	20	----	4	50.80	48.26	11.94	8.13
-----	-----	87898-2065	-----	-----	-----	20	----	5	50.80	48.26	11.94	8.13
-----	-----	87898-2066	-----	-----	-----	20	----	6	50.80	48.26	11.94	8.13
-----	-----	87898-2161	-----	-----	-----	21	----	1	53.34	50.80	11.94	8.13
-----	-----	87898-2162	-----	-----	-----	21	----	2	53.34	50.80	11.94	8.13
-----	-----	87898-2164	-----	-----	-----	21	----	4	53.34	50.80	11.94	8.13
-----	-----	87898-2165	-----	-----	-----	21	----	5	53.34	50.80	11.94	8.13
-----	-----	87898-2166	-----	-----	-----	21	----	6	53.34	50.80	11.94	8.13

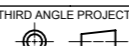
THIS DRAWING CONTAINS INFORMATION THAT IS PROPRIETARY TO MOLEX ELECTRONIC TECHNOLOGIES, LLC AND SHOULD NOT BE USED WITHOUT WRITTEN PERMISSION												
DIMENSION UNITS		SCALE		CURRENT REV DESC:								
mm		NTS										
GENERAL TOLERANCES (UNLESS SPECIFIED)				EC NO: 698212 DRWN: DANUSA 2022/03/03 CHK'D: DANUSA 2022/03/04 APPR: MRAMAKRISHNA 2022/03/04				CUSTOM HEADER 2.54MM PITCH SINGLE ROW SINGLE WAFER SMT HEADER				
		MM	INCH									
4 PLACES	±		±	INITIAL REVISION: DRWN: SKLIM01 2005/10/26 APPR: PTLIM 2005/11/07				DOCUMENT NUMBER		DOC TYPE	DOC PART	REVISION
3 PLACES	±		±					SD-87898-003		PSD	001	C1
2 PLACES	±	0.2	±	DRAFT WHERE APPLICABLE MUST REMAIN WITHIN DIMENSIONS				MATERIAL NUMBER		CUSTOMER		SHEET NUMBER
1 PLACE	±		±					SEE TABLE		GENERAL MARKET		10 OF 17
0 PLACES	±		±	THIRD ANGLE PROJECTION		DRAWING	SERIES	CUSTOMER		SHEET NUMBER		
ANGULAR TOL		± 3.0°				A3-SIZE	87898	GENERAL MARKET		10 OF 17		

PACKAGING OPTION PART NO.						CKT SIZE	VOID POSITION	PLATING TYPE	DIMENSION			
TRAY WITHOUT CAP	TRAY WITH CAP	TUBE WITHOUT CAP	TUBE WITH CAP	TAPE & REEL WITHOUT CAP	TAPE & REEL WITH CAP				A	B	F	M
-----	-----	87898-2261	-----	-----	-----	22	----	1	55.88	53.34	11.94	8.13
-----	-----	87898-2262	-----	-----	-----	22	----	2	55.88	53.34	11.94	8.13
-----	-----	87898-2264	-----	-----	-----	22	----	4	55.88	53.34	11.94	8.13
-----	-----	87898-2265	-----	-----	-----	22	----	5	55.88	53.34	11.94	8.13
-----	-----	87898-2266	-----	-----	-----	22	----	6	55.88	53.34	11.94	8.13
-----	-----	87898-2361	-----	-----	-----	23	----	1	58.42	55.88	11.94	8.13
-----	-----	87898-2362	-----	-----	-----	23	----	2	58.42	55.88	11.94	8.13
-----	-----	87898-2364	-----	-----	-----	23	----	4	58.42	55.88	11.94	8.13
-----	-----	87898-2365	-----	-----	-----	23	----	5	58.42	55.88	11.94	8.13
-----	-----	87898-2366	-----	-----	-----	23	----	6	58.42	55.88	11.94	8.13
-----	-----	87898-2461	-----	-----	-----	24	----	1	60.96	58.42	11.94	8.13
-----	-----	87898-2462	-----	-----	-----	24	----	2	60.96	58.42	11.94	8.13
-----	-----	87898-2464	-----	-----	-----	24	----	4	60.96	58.42	11.94	8.13
-----	-----	87898-2465	-----	-----	-----	24	----	5	60.96	58.42	11.94	8.13
-----	-----	87898-2466	-----	-----	-----	24	----	6	60.96	58.42	11.94	8.13

THIS DRAWING CONTAINS INFORMATION THAT IS PROPRIETARY TO MOLEX ELECTRONIC TECHNOLOGIES, LLC AND SHOULD NOT BE USED WITHOUT WRITTEN PERMISSION												
DIMENSION UNITS		SCALE		CURRENT REV DESC:								
mm		NTS		EC NO: 698212								
GENERAL TOLERANCES (UNLESS SPECIFIED)				DRWN: DANUSA 2022/03/03				CUSTOM HEADER 2.54MM PITCH SINGLE ROW SINGLE WAFER SMT HEADER				
				CHK'D: DANUSA 2022/03/04								
				APPR: MRAMAKRISHNA 2022/03/04				PRODUCT CUSTOMER DRAWING				
				INITIAL REVISION:				DOCUMENT NUMBER		DOC TYPE	DOC PART	REVISION
4 PLACES ±				DRWN: SKLIM01 2005/10/26				SD-87898-003		PSD	001	C1
3 PLACES ±				APPR: PTLIM 2005/11/07								
2 PLACES ± 0.2												
1 PLACE ±												
0 PLACES ±												
ANGULAR TOL ± 3.0°				DRAFT WHERE APPLICABLE MUST REMAIN WITHIN DIMENSIONS				THIRD ANGLE PROJECTION	DRAWING	SERIES	MATERIAL NUMBER	CUSTOMER
				A3-SIZE	87898	SEE TABLE	GENERAL MARKET	SHEET NUMBER				
											11 OF 17	

PACKAGING OPTION PART NO.						CKT SIZE	VOID POSITION	PLATING TYPE	DIMENSION			
TRAY WITHOUT CAP	TRAY WITH CAP	TUBE WITHOUT CAP	TUBE WITH CAP	TAPE & REEL WITHOUT CAP	TAPE & REEL WITH CAP				A	B	F	M
-----	-----	87898-2561	-----	-----	-----	25	----	1	63.50	60.96	11.94	8.13
-----	-----	87898-2562	-----	-----	-----	25	----	2	63.50	60.96	11.94	8.13
-----	-----	87898-2564	-----	-----	-----	25	----	4	63.50	60.96	11.94	8.13
-----	-----	87898-2565	-----	-----	-----	25	----	5	63.50	60.96	11.94	8.13
-----	-----	87898-2566	-----	-----	-----	25	----	6	63.50	60.96	11.94	8.13
-----	-----	87898-2661	-----	-----	-----	26	----	1	66.04	63.50	11.94	8.13
-----	-----	87898-2662	-----	-----	-----	26	----	2	66.04	63.50	11.94	8.13
-----	-----	87898-2664	-----	-----	-----	26	----	4	66.04	63.50	11.94	8.13
-----	-----	87898-2665	-----	-----	-----	26	----	5	66.04	63.50	11.94	8.13
-----	-----	87898-2666	-----	-----	-----	26	----	6	66.04	63.50	11.94	8.13
-----	-----	87898-2761	-----	-----	-----	27	----	1	68.58	66.04	11.94	8.13
-----	-----	87898-2762	-----	-----	-----	27	----	2	68.58	66.04	11.94	8.13
-----	-----	87898-2764	-----	-----	-----	27	----	4	68.58	66.04	11.94	8.13
-----	-----	87898-2765	-----	-----	-----	27	----	5	68.58	66.04	11.94	8.13
-----	-----	87898-2766	-----	-----	-----	27	----	6	68.58	66.04	11.94	8.13

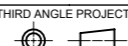
THIS DRAWING CONTAINS INFORMATION THAT IS PROPRIETARY TO MOLEX ELECTRONIC TECHNOLOGIES, LLC AND SHOULD NOT BE USED WITHOUT WRITTEN PERMISSION												
DIMENSION UNITS		SCALE		CURRENT REV DESC:								
mm		NTS										
GENERAL TOLERANCES (UNLESS SPECIFIED)				EC NO: 698212 DRWN: DANUSA 2022/03/03 CHK'D: DANUSA 2022/03/04 APPR: MRAMAKRISHNA 2022/03/04				CUSTOM HEADER 2.54MM PITCH SINGLE ROW SINGLE WAFER SMT HEADER				
		MM	INCH									
4 PLACES	±		±	INITIAL REVISION: DRWN: SKLIM01 2005/10/26 APPR: PTLIM 2005/11/07				DOCUMENT NUMBER		DOC TYPE	DOC PART	REVISION
3 PLACES	±		±					SD-87898-003		PSD	001	C1
2 PLACES	±	0.2	±	DRAFT WHERE APPLICABLE MUST REMAIN WITHIN DIMENSIONS				MATERIAL NUMBER		CUSTOMER		SHEET NUMBER
1 PLACE	±		±					SEE TABLE		GENERAL MARKET		12 OF 17
0 PLACES	±		±	THIRD ANGLE PROJECTION		DRAWING	SERIES	CUSTOMER		SHEET NUMBER		
ANGULAR TOL		± 3.0°				A3-SIZE	87898	GENERAL MARKET		12 OF 17		

PACKAGING OPTION PART NO.						CKT SIZE	VOID POSITION	PLATING TYPE	DIMENSION			
TRAY WITHOUT CAP	TRAY WITH CAP	TUBE WITHOUT CAP	TUBE WITH CAP	TAPE & REEL WITHOUT CAP	TAPE & REEL WITH CAP				A	B	F	M
-----	-----	87898-2861	-----	-----	-----	28	----	1	71.12	68.58	11.94	8.13
-----	-----	87898-2862	-----	-----	-----	28	----	2	71.12	68.58	11.94	8.13
-----	-----	87898-2864	-----	-----	-----	28	----	4	71.12	68.58	11.94	8.13
-----	-----	87898-2865	-----	-----	-----	28	----	5	71.12	68.58	11.94	8.13
-----	-----	87898-2866	-----	-----	-----	28	----	6	71.12	68.58	11.94	8.13
-----	-----	87898-2961	-----	-----	-----	29	----	1	73.66	71.12	11.94	8.13
-----	-----	87898-2962	-----	-----	-----	29	----	2	73.66	71.12	11.94	8.13
-----	-----	87898-2964	-----	-----	-----	29	----	4	73.66	71.12	11.94	8.13
-----	-----	87898-2965	-----	-----	-----	29	----	5	73.66	71.12	11.94	8.13
-----	-----	87898-2966	-----	-----	-----	29	----	6	73.66	71.12	11.94	8.13
-----	-----	87898-3061	-----	-----	-----	30	----	1	76.20	73.66	11.94	8.13
-----	-----	87898-3062	-----	-----	-----	30	----	2	76.20	73.66	11.94	8.13
-----	-----	87898-3064	-----	-----	-----	30	----	4	76.20	73.66	11.94	8.13
-----	-----	87898-3065	-----	-----	-----	30	----	5	76.20	73.66	11.94	8.13
-----	-----	87898-3066	-----	-----	-----	30	----	6	76.20	73.66	11.94	8.13

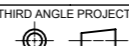
THIS DRAWING CONTAINS INFORMATION THAT IS PROPRIETARY TO MOLEX ELECTRONIC TECHNOLOGIES, LLC AND SHOULD NOT BE USED WITHOUT WRITTEN PERMISSION												
DIMENSION UNITS		SCALE		CURRENT REV DESC:								
mm		NTS										
GENERAL TOLERANCES (UNLESS SPECIFIED)				EC NO: 698212 DRWN: DANUSA 2022/03/03 CHK'D: DANUSA 2022/03/04 APPR: MRAMAKRISHNA 2022/03/04				CUSTOM HEADER 2.54MM PITCH SINGLE ROW SINGLE WAFER SMT HEADER				
		MM	INCH									
4 PLACES	±		±	INITIAL REVISION: DRWN: SKLIM01 2005/10/26 APPR: PTLIM 2005/11/07				DOCUMENT NUMBER		DOC TYPE	DOC PART	REVISION
3 PLACES	±		±					SD-87898-003		PSD	001	C1
2 PLACES	±	0.2	±	DRAFT WHERE APPLICABLE MUST REMAIN WITHIN DIMENSIONS				MATERIAL NUMBER		CUSTOMER		SHEET NUMBER
1 PLACE	±		±					SEE TABLE		GENERAL MARKET		13 OF 17
0 PLACES	±		±	THIRD ANGLE PROJECTION		DRAWING	SERIES	CUSTOMER		SHEET NUMBER		
ANGULAR TOL		± 3.0°				A3-SIZE	87898	GENERAL MARKET		13 OF 17		

PACKAGING OPTION PART NO.						CKT SIZE	VOID POSITION	PLATING TYPE	DIMENSION			
TRAY WITHOUT CAP	TRAY WITH CAP	TUBE WITHOUT CAP	TUBE WITH CAP	TAPE & REEL WITHOUT CAP	TAPE & REEL WITH CAP				A	B	F	M
-----	-----	87898-3161	-----	-----	-----	31	----	1	78.74	76.20	11.94	8.13
-----	-----	87898-3162	-----	-----	-----	31	----	2	78.74	76.20	11.94	8.13
-----	-----	87898-3164	-----	-----	-----	31	----	4	78.74	76.20	11.94	8.13
-----	-----	87898-3165	-----	-----	-----	31	----	5	78.74	76.20	11.94	8.13
-----	-----	87898-3166	-----	-----	-----	31	----	6	78.74	76.20	11.94	8.13
-----	-----	87898-3261	-----	-----	-----	32	----	1	81.28	78.74	11.94	8.13
-----	-----	87898-3262	-----	-----	-----	32	----	2	81.28	78.74	11.94	8.13
-----	-----	87898-3264	-----	-----	-----	32	----	4	81.28	78.74	11.94	8.13
-----	-----	87898-3265	-----	-----	-----	32	----	5	81.28	78.74	11.94	8.13
-----	-----	87898-3266	-----	-----	-----	32	----	6	81.28	78.74	11.94	8.13
-----	-----	87898-3361	-----	-----	-----	33	----	1	83.82	81.28	11.94	8.13
-----	-----	87898-3362	-----	-----	-----	33	----	2	83.82	81.28	11.94	8.13
-----	-----	87898-3364	-----	-----	-----	33	----	4	83.82	81.28	11.94	8.13
-----	-----	87898-3365	-----	-----	-----	33	----	5	83.82	81.28	11.94	8.13
-----	-----	87898-3366	-----	-----	-----	33	----	6	83.82	81.28	11.94	8.13

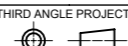
THIS DRAWING CONTAINS INFORMATION THAT IS PROPRIETARY TO MOLEX ELECTRONIC TECHNOLOGIES, LLC AND SHOULD NOT BE USED WITHOUT WRITTEN PERMISSION												
DIMENSION UNITS		SCALE		CURRENT REV DESC:								
mm		NTS		EC NO: 698212								
GENERAL TOLERANCES (UNLESS SPECIFIED)				DRWN: DANUSA 2022/03/03				CUSTOM HEADER 2.54MM PITCH SINGLE ROW SINGLE WAFER SMT HEADER				
				CHK'D: DANUSA 2022/03/04								
				APPR: MRAMAKRISHNA 2022/03/04				PRODUCT CUSTOMER DRAWING				
				INITIAL REVISION:				DOCUMENT NUMBER		DOC TYPE	DOC PART	REVISION
4 PLACES ±				DRWN: SKLIM01 2005/10/26				SD-87898-003		PSD	001	C1
3 PLACES ±				APPR: PTLIM 2005/11/07								
2 PLACES ± 0.2												
1 PLACE ±												
0 PLACES ±												
ANGULAR TOL ± 3.0°				DRAFT WHERE APPLICABLE MUST REMAIN WITHIN DIMENSIONS				THIRD ANGLE PROJECTION	DRAWING	SERIES	MATERIAL NUMBER	CUSTOMER
					A3-SIZE	87898	SEE TABLE	GENERAL MARKET	SHEET NUMBER			
											14 OF 17	

PACKAGING OPTION PART NO.						CKT SIZE	VOID POSITION	PLATING TYPE	DIMENSION			
TRAY WITHOUT CAP	TRAY WITH CAP	TUBE WITHOUT CAP	TUBE WITH CAP	TAPE & REEL WITHOUT CAP	TAPE & REEL WITH CAP				A	B	F	M
-----	-----	87898-3461	-----	-----	-----	34	----	1	86.36	83.82	11.94	8.13
-----	-----	87898-3462	-----	-----	-----	34	----	2	86.36	83.82	11.94	8.13
-----	-----	87898-3464	-----	-----	-----	34	----	4	86.36	83.82	11.94	8.13
-----	-----	87898-3465	-----	-----	-----	34	----	5	86.36	83.82	11.94	8.13
-----	-----	87898-3466	-----	-----	-----	34	----	6	86.36	83.82	11.94	8.13
-----	-----	87898-3561	-----	-----	-----	35	----	1	88.90	86.36	11.94	8.13
-----	-----	87898-3562	-----	-----	-----	35	----	2	88.90	86.36	11.94	8.13
-----	-----	87898-3564	-----	-----	-----	35	----	4	88.90	86.36	11.94	8.13
-----	-----	87898-3565	-----	-----	-----	35	----	5	88.90	86.36	11.94	8.13
-----	-----	87898-3566	-----	-----	-----	35	----	6	88.90	86.36	11.94	8.13
-----	-----	87898-3661	-----	-----	-----	36	----	1	91.44	88.90	11.94	8.13
-----	-----	87898-3662	-----	-----	-----	36	----	2	91.44	88.90	11.94	8.13
-----	-----	87898-3664	-----	-----	-----	36	----	4	91.44	88.90	11.94	8.13
-----	-----	87898-3665	-----	-----	-----	36	----	5	91.44	88.90	11.94	8.13
-----	-----	87898-3666	-----	-----	-----	36	----	6	91.44	88.90	11.94	8.13

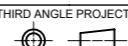
THIS DRAWING CONTAINS INFORMATION THAT IS PROPRIETARY TO MOLEX ELECTRONIC TECHNOLOGIES, LLC AND SHOULD NOT BE USED WITHOUT WRITTEN PERMISSION													
DIMENSION UNITS		SCALE		CURRENT REV DESC:									
mm		NTS											
GENERAL TOLERANCES (UNLESS SPECIFIED)				EC NO: 698212 DRWN: DANUSA 2022/03/03 CHK'D: DANUSA 2022/03/04 APPR: MRAMAKRISHNA 2022/03/04						CUSTOM HEADER 2.54MM PITCH SINGLE ROW SINGLE WAFER SMT HEADER			
		MM	INCH										
4 PLACES	±		±	INITIAL REVISION: DRWN: SKLIM01 2005/10/26 APPR: PTLIM 2005/11/07						PRODUCT CUSTOMER DRAWING DOCUMENT NUMBER: SD-87898-003 DOC TYPE: PSD DOC PART: 001 REVISION: C1			
3 PLACES	±		±										
2 PLACES	±	0.2	±	DRAFT WHERE APPLICABLE MUST REMAIN WITHIN DIMENSIONS						THIRD ANGLE PROJECTION 			
1 PLACE	±		±										
0 PLACES	±		±	DRAWING		SERIES		MATERIAL NUMBER		CUSTOMER		SHEET NUMBER	
ANGULAR TOL ± 3.0°				A3-SIZE		87898		SEE TABLE		GENERAL MARKET		15 OF 17	

PACKAGING OPTION PART NO.						CKT SIZE	VOID POSITION	PLATING TYPE	DIMENSION			
TRAY WITHOUT CAP	TRAY WITH CAP	TUBE WITHOUT CAP	TUBE WITH CAP	TAPE & REEL WITHOUT CAP	TAPE & REEL WITH CAP				A	B	F	M
-----	-----	87898-3761	-----	-----	-----	37	----	1	93.98	91.44	11.94	8.13
-----	-----	87898-3762	-----	-----	-----	37	----	2	93.98	91.44	11.94	8.13
-----	-----	87898-3764	-----	-----	-----	37	----	4	93.98	91.44	11.94	8.13
-----	-----	87898-3765	-----	-----	-----	37	----	5	93.98	91.44	11.94	8.13
-----	-----	87898-3766	-----	-----	-----	37	----	6	93.98	91.44	11.94	8.13
-----	-----	87898-3861	-----	-----	-----	38	----	1	96.52	93.98	11.94	8.13
-----	-----	87898-3862	-----	-----	-----	38	----	2	96.52	93.98	11.94	8.13
-----	-----	87898-3864	-----	-----	-----	38	----	4	96.52	93.98	11.94	8.13
-----	-----	87898-3865	-----	-----	-----	38	----	5	96.52	93.98	11.94	8.13
-----	-----	87898-3866	-----	-----	-----	38	----	6	96.52	93.98	11.94	8.13
-----	-----	87898-3961	-----	-----	-----	39	----	1	99.06	96.52	11.94	8.13
-----	-----	87898-3962	-----	-----	-----	39	----	2	99.06	96.52	11.94	8.13
-----	-----	87898-3964	-----	-----	-----	39	----	4	99.06	96.52	11.94	8.13
-----	-----	87898-3965	-----	-----	-----	39	----	5	99.06	96.52	11.94	8.13
-----	-----	87898-3966	-----	-----	-----	39	----	6	99.06	96.52	11.94	8.13

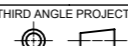
THIS DRAWING CONTAINS INFORMATION THAT IS PROPRIETARY TO MOLEX ELECTRONIC TECHNOLOGIES, LLC AND SHOULD NOT BE USED WITHOUT WRITTEN PERMISSION																					
DIMENSION UNITS		SCALE		CURRENT REV DESC:																	
mm		NTS																			
GENERAL TOLERANCES (UNLESS SPECIFIED)				EC NO: 698212 DRWN: DANUSA 2022/03/03 CHK'D: DANUSA 2022/03/04 APPR: MRAMAKRISHNA 2022/03/04						CUSTOM HEADER 2.54MM PITCH SINGLE ROW SINGLE WAFER SMT HEADER											
		MM	INCH																		
4 PLACES		±	±	INITIAL REVISION: DRWN: SKLIM01 2005/10/26 APPR: PTLIM 2005/11/07						DOCUMENT NUMBER SD-87898-003		DOC TYPE PSD	DOC PART 001	REVISION C1							
3 PLACES		±	±																		
2 PLACES		± 0.2	±	DRAFT WHERE APPLICABLE MUST REMAIN WITHIN DIMENSIONS						THIRD ANGLE PROJECTION 		DRAWING A3-SIZE		SERIES 87898		MATERIAL NUMBER SEE TABLE		CUSTOMER GENERAL MARKET		SHEET NUMBER 16 OF 17	
1 PLACE		±	±																		
0 PLACES		±	±	ANGULAR TOL		± 3.0°															

PACKAGING OPTION PART NO.						CKT SIZE	VOID POSITION	PLATING TYPE	DIMENSION			
TRAY WITHOUT CAP	TRAY WITH CAP	TUBE WITHOUT CAP	TUBE WITH CAP	TAPE & REEL WITHOUT CAP	TAPE & REEL WITH CAP				A	B	F	M
-----	-----	87898-4061	-----	-----	-----	40	----	1	101.6	99.06	11.94	8.13
-----	-----	87898-4062	-----	-----	-----	40	----	2	101.6	99.06	11.94	8.13
-----	-----	87898-4064	-----	-----	-----	40	----	4	101.6	99.06	11.94	8.13
-----	-----	87898-4065	-----	-----	-----	40	----	5	101.6	99.06	11.94	8.13
-----	-----	87898-4066	-----	-----	-----	40	----	6	101.6	99.06	11.94	8.13

E

E

D

D

C

C

B

B

A

A

THIS DRAWING CONTAINS INFORMATION THAT IS PROPRIETARY TO MOLEX ELECTRONIC TECHNOLOGIES, LLC AND SHOULD NOT BE USED WITHOUT WRITTEN PERMISSION												
DIMENSION UNITS		SCALE		CURRENT REV DESC:								
mm		NTS										
GENERAL TOLERANCES (UNLESS SPECIFIED)				EC NO: 698212 DRWN: DANUSA 2022/03/03 CHK'D: DANUSA 2022/03/04 APPR: MRAMAKRISHNA 2022/03/04				CUSTOM HEADER 2.54MM PITCH SINGLE ROW SINGLE WAFER SMT HEADER				
4 PLACES ±		±		INITIAL REVISION: DRWN: SKLIM01 2005/10/26 APPR: PTLIM 2005/11/07				DOCUMENT NUMBER		DOC TYPE	DOC PART	REVISION
3 PLACES ±		±						SD-87898-003		PSD	001	C1
2 PLACES ±		0.2 ±		DRAFT WHERE APPLICABLE MUST REMAIN WITHIN DIMENSIONS				MATERIAL NUMBER		CUSTOMER		SHEET NUMBER
1 PLACE ±		±						SEE TABLE		GENERAL MARKET		17 OF 17
0 PLACES ±		±		THIRD ANGLE PROJECTION		DRAWING	SERIES	MATERIAL NUMBER	CUSTOMER		SHEET NUMBER	
ANGULAR TOL ± 3.0°		± 3.0°		A3-SIZE	87898	SEE TABLE		GENERAL MARKET		17 OF 17		