

TYPICAL SWITCH ORDERING EXAMPLE

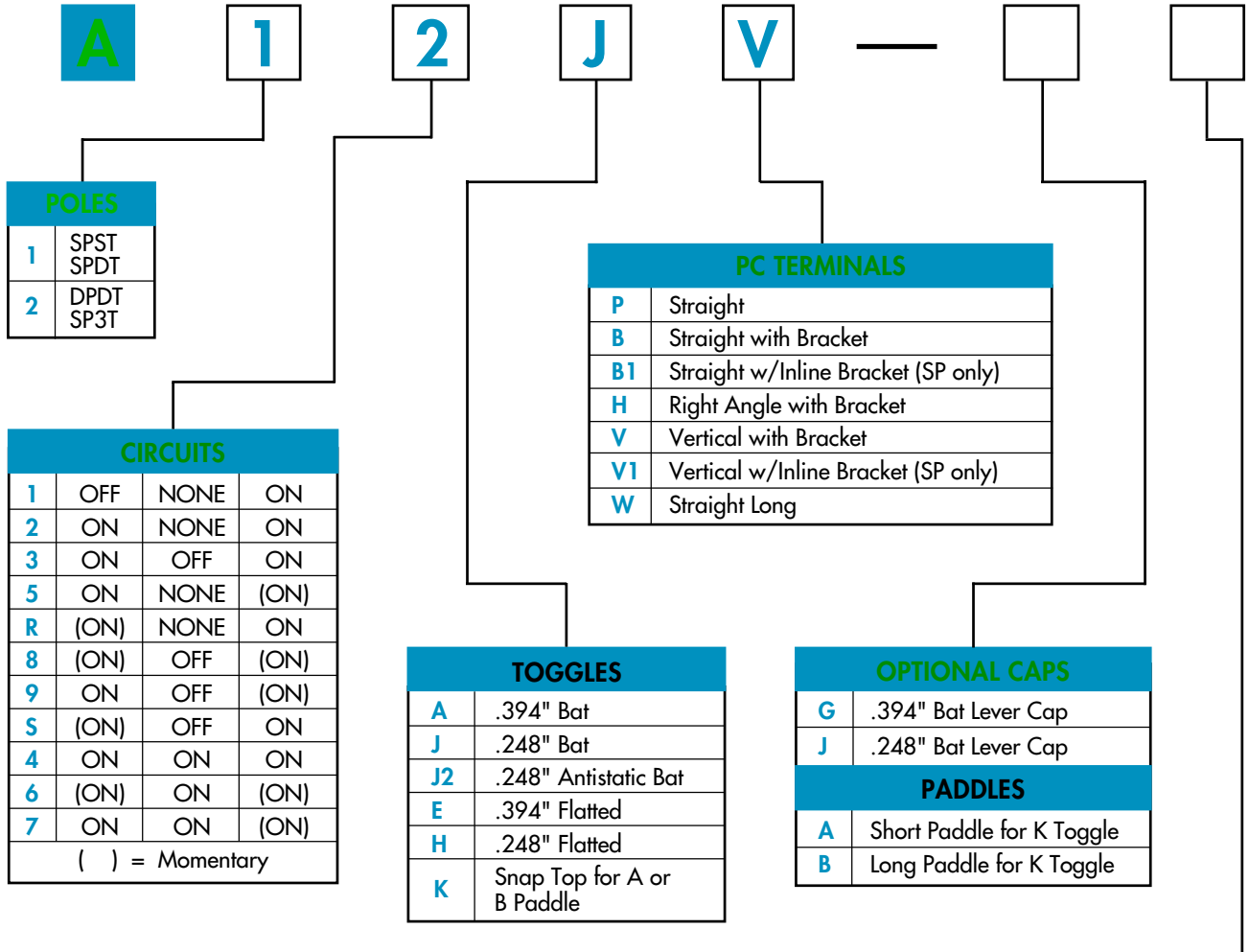

DESCRIPTION FOR TYPICAL ORDERING EXAMPLE

A12JV

.248" Long Bat Toggle ——— Vertical PC Terminals
 SPDT ———
 ON-NONE-ON Circuit



CAP COLORS		PADDLE COLORS	
A	Black	A	
B	White	B	
C	Red	C	
---	Yellow	E	
---	Green	F	
---	Blue	G	
---	Gray	H	

GENERAL SPECIFICATIONS

Electrical Capacity (Resistive Load)

Logic Level: 0.4VA maximum @ 28V AC/DC maximum
(Applicable Range 0.1mA ~ 0.1A @ 20mV ~ 28V)

Note: See Supplement Index (page Z1) to find explanation of operating range.

Other Ratings

Contact Resistance: 50 milliohms maximum
Insulation Resistance: 500 megohms minimum @ 500V DC
Dielectric Strength: 500V AC minimum
Mechanical Life: 100,000 operations minimum for On-None-On & On-Off-On
 50,000 operations minimum for other circuits
Electrical Life: 50,000 operations minimum
Nominal Operating Force: Toggles A & E: 150 grams (momentary); 120 grams (maintained)
 Toggles J, J2, & H: 278 grams (momentary); 188 grams (maintained)
Contact Timing: Nonshorting (break-before-make)
Angle of Throw: 26°

Materials & Finishes

Toggle: Glass fiber reinforced polyamide for antistatic; nickel plated brass for all others
Case Housing: Glass fiber reinforced polyamide
Support Bracket: Tin plated phosphor bronze
Movable Contact: Phosphor bronze with gold plating over silver plating
Stationary Contacts: Brass with gold plating over nickel undercoating

Environmental Data

Operating Temp Range: -30°C through +85°C (-22°F through +185°F)
Humidity: 90 ~ 95% humidity for 96 hours @ 40°C (104°F)
Vibration: 10 ~ 55Hz with peak-to-peak amplitude of 1.5mm traversing the frequency range & returning in 1 minute; 3 right angled directions for 2 hours
Shock: 50g acceleration (tested in 6 right angled directions, with 3 shocks in each direction)

Installation

Soldering Time & Temperature: 3 seconds @ 350°C or 5 seconds @ 270°C
Process Seal: See Supplement Index (page Z1) for specific processing data.

Standards & Certifications

IECQ Approved: All toggle models recognized at 0.4VA maximum @ 28V AC/DC maximum
 Qualification Approval Number: JP792-3A

POLES & CIRCUITS

		Toggle Position () = Momentary			Connected Terminals			Throw & Schematics
Pole	Model	Up	Center	Down	Up	Center	Down	Note: Terminal numbers are not actually on the switch.
SP	A11	OFF	NONE	ON	OPEN	OPEN	3-1	SPST
SP	A12 A13 A15 A1R A18 A19 A1S	ON ON ON (ON) (ON) ON (ON)	NONE OFF NONE NONE OFF OFF OFF	ON ON (ON) ON (ON) (ON) ON	2-3	OPEN	2-1	SPDT
DP	A22 A23 A25 A2R A28 A29 A2S	ON ON ON (ON) (ON) ON (ON)	NONE OFF NONE NONE OFF OFF OFF	ON ON (ON) ON (ON) (ON) ON	2-3 5-6	OPEN	2-1 5-4	DPDT

For 3 Throw (3-On)

		Connected Terminals & Schematics			External Connection
Pole	Model	Up	Center	Down	
SP	A24 A26 A27	ON (ON) ON 2-3 5-6	ON ON ON 2-3 5-4	ON (ON) (ON) 2-1 5-4	The SP3T model utilizes a double pole base. External connections must be made during field installation.

TOGGLES

Standard Material & Finish: Brass with Bright Nickel Material & Finish for J2: Matte finish black glass fiber reinforced polyamide

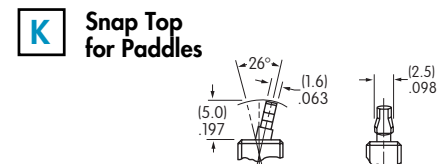
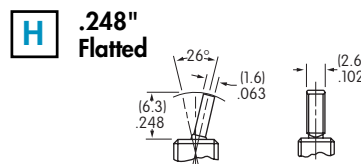
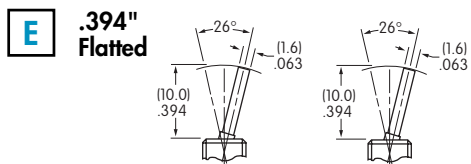
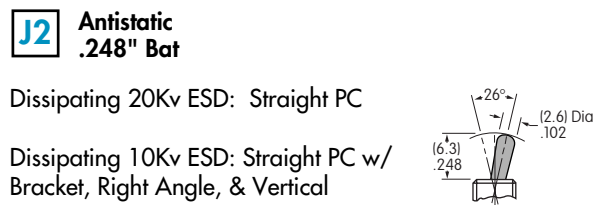
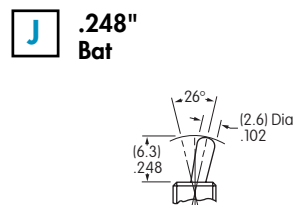
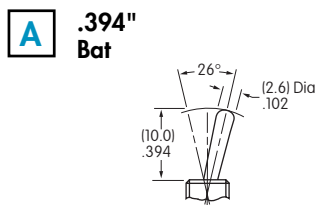

PC TERMINALS

Use of a support bracket or placement of the square bushing in a panel cutout is recommended to increase PCB mounting stability.

P Straight

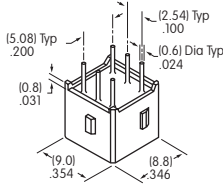

B Straight with Bracket

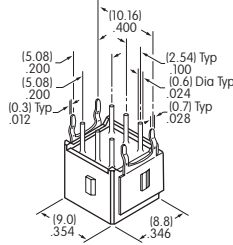

B1 Straight with Inline Bracket (SP only)

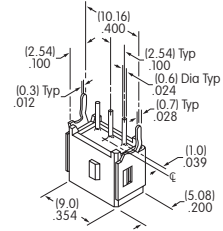

H Right Angle with Bracket

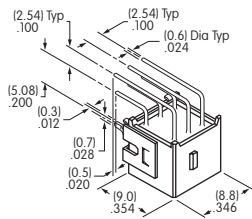

V Vertical with Bracket

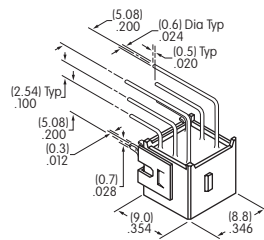

V1 Vertical with Inline Bracket (SP only)

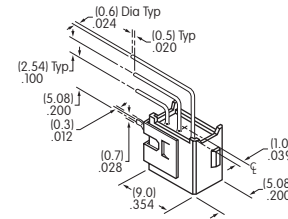

W Straight Long

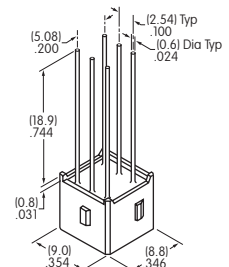

CAPS & PADDLES

G AT4003
.394" Bat Lever Cap

Material: PVC
Colors Available:
A, B, C

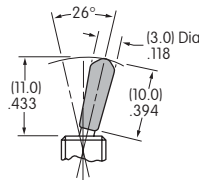

J AT4064
.248" Bat Lever Cap

Material: PVC
Colors Available:
A, B, C

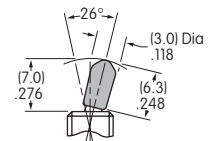

A AT467
Short Paddle

Material: PBT
Colors Available:
A, B, C, E, F, G, H

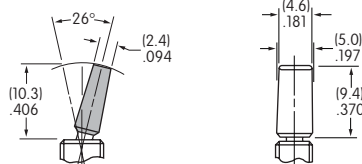

B AT468
Long Paddle

Material: PBT
Colors Available:
A, B, C, E, F, G, H

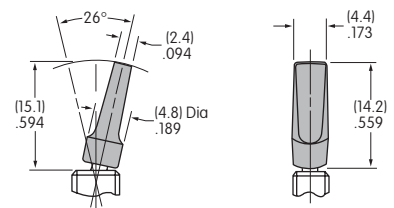

Color Codes: **A** Black **B** White **C** Red **E** Yellow **F** Green **G** Blue **H** Gray

TYPICAL SWITCH DIMENSIONS

Straight PC

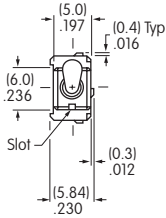

Single Pole

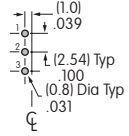
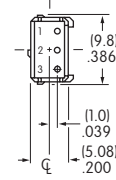
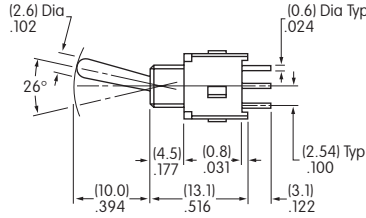

A12AP

A11 models do not have Terminal 2.

Straight PC

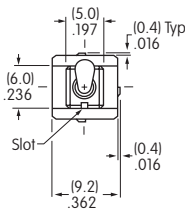

Double Pole

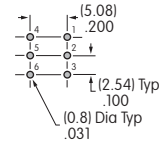
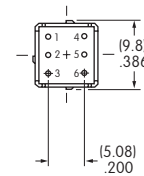
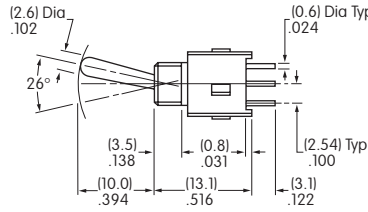

A22AP

Straight PC • Bracket

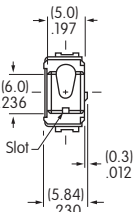

Single Pole

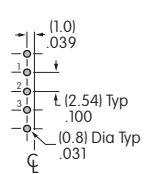
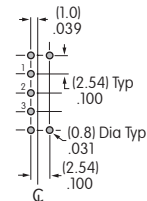
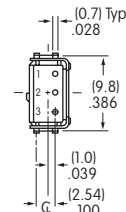
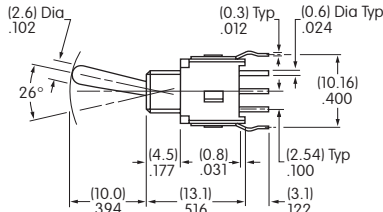

A12AB

B Terminals

B1 Terminals

Straight PC • Bracket

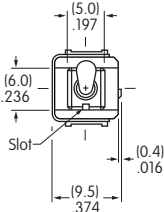

Double Pole

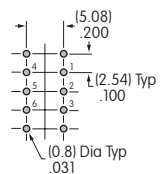
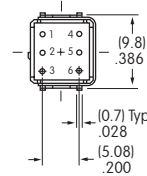
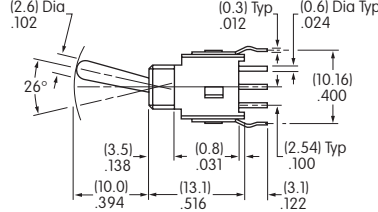

A22AB

TYPICAL SWITCH DIMENSIONS

Right Angle PC

Single Pole

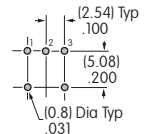
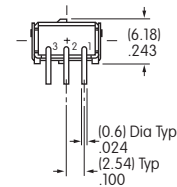
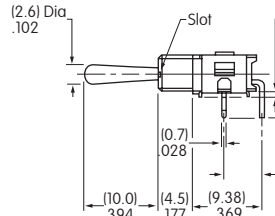
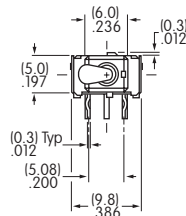

A12AH

Right Angle PC

Double Pole

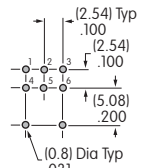
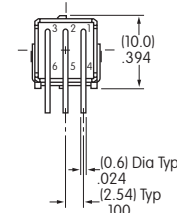
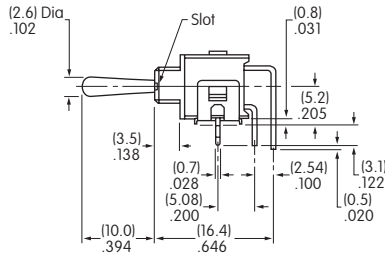
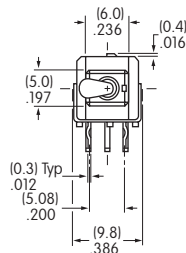

A22AH

Vertical PC

Single Pole

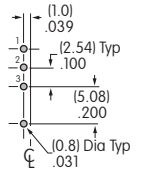
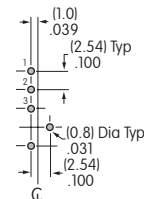
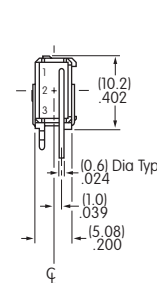
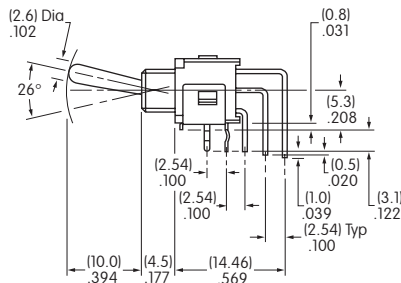
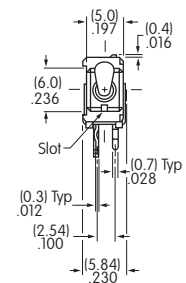

A12AV

V Terminals

V1 Terminals

Vertical PC

Double Pole

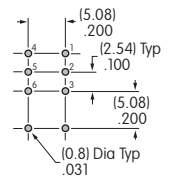
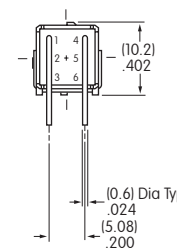
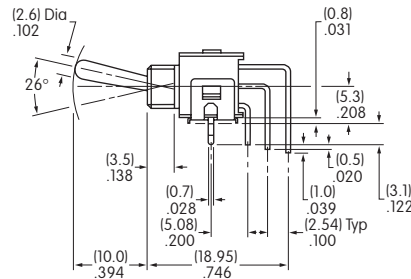
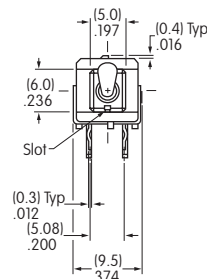

A22AV