

User Guide 1.0

IRAC11662-100W

+16V Low-side Smart Rectification 100W Flyback Demo Board User's Guide

by

HELEN DING, ISRAEL SERRANO

19 April 2010

	Page(s)
Table of Contents	2
1.0 INTRODUCTION	3
2.0 GENERAL DESCRIPTION	3
2.1 IRAC11662-100W +16V Demo Board Schematic Diagram	4
2.2 IRAC11662-100W +16V Demo Board Pictures	5
2.3 IRAC11662-100W +16V Demo Board PCB Layout	6
3.0 Circuit Description	7
4.0 Test Connection and Set up Pictures	8
5.0 Circuit Features	9
5.1 OVT Setting	9
5.2 ENABLE Setting	9
5.3 MOT Setting	9
5.4 Mosfet Selection Design Tips	10
6.0 Test Waveforms	11-17
6.1.1 Transient Load Test	11-13
6.1.2 Static Load Test	14-15
6.1.3 Ripple And Noise Measurement	16
6.1.4 Dynamic load Test	17
7.0 Line / Load Regulation Test	18
7.1 IR11662 Demo Board V-I Characteristics Curve	18
7.2 System Efficiency Test	19
7.3 Thermal Verification	20
8.0 Summary	21
9.0 Appendix	21-25
9.1 Transformer turns ratio, Duty Cycle and Secondary Current Relationship Chart	21
9.2 IR11662 100W +16V SR Demo Board Power Transformer Specs	22
10.0 IRAC11662-100W +16V Demo Board Bill of Materials (BOM)	23-24

1.0 INTRODUCTION

Generally, Schottky diodes are traditional devices use in passive rectification in order to have low conduction loss in secondary side for switching power supplies. The proliferations of synchronous rectification (SR) idea - which is mostly use in buck-derive topologies - have reached the domain of flyback application in recent years. The use of low-voltage-low-Rdson mosfet has become so attractive to replace the Schottky rectifiers in high current applications because it offers several system advantages such as dramatic decrease in conduction loss and better thermal management of the whole system by reducing the cost investment in heat sink and PCB space.

A number of techniques in the implementation of SR in flyback converters are continuously growing from a simple self-driven (secondary winding voltage detection) to a more complex solution using “current transformer sensing” or combinations of both to improve the existing technology. The idea has become quite complicated though and additional discrete devices have made the cost and part counts issue even worse. Moreover, the issue of reverse current conduction (-due to the delay in sensing the sharp drop of secondary current during turn-off phase of the SR) still lingers on in different input line/ output load conditions. The use of a simple fast-rate-direct-sensing of voltage drop across the mosfet (Vsd) using integrated solution has pave the way for a much simpler and effective means of controlling the SR mosfets as well as alleviating the reverse current and multiple-pulse gate turn-ON issues.

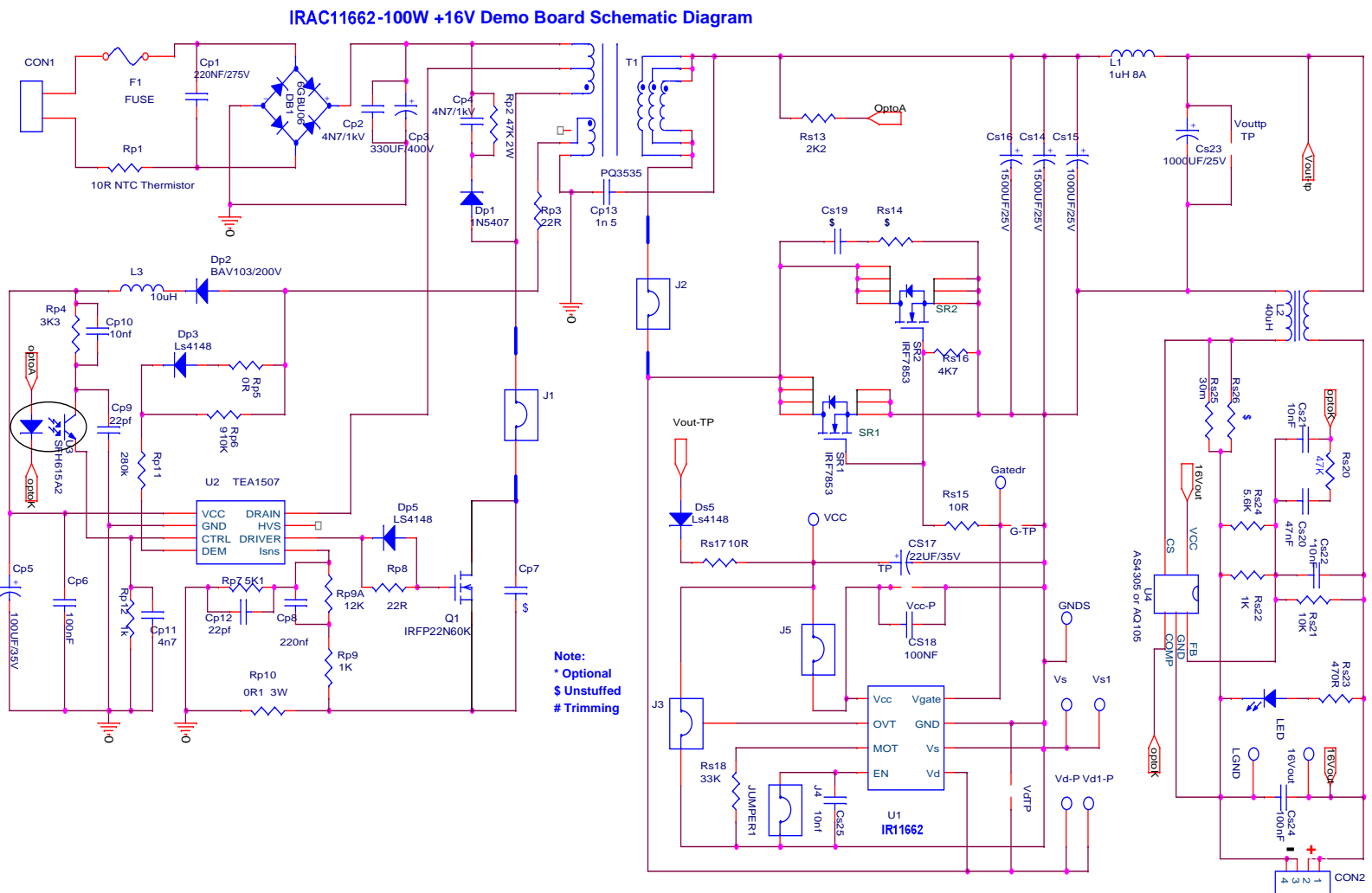
The objective of this user guide is to show the advantages of SR application using integrated IC approach and study the practical limits of the efficiency improvements vs. the normal rectification method.

2.0 GENERAL DESCRIPTION

The IRAC11662-100W demo board is a universal-input flyback converter with single DC output capable of delivering continuous 100W (@ +16V x 6.25A) during active rectification mode. This demo board is primarily designed to study synchronous rectification using IR11662 in low-side configuration to take advantage of simpler derivation of Vcc supply from converter’s output. It is equipped with necessary jumpers to ease exploring the conduction behavior of synchronous rectifiers SRs in quasi-resonant mode, so discussion would be confined to variable frequency switching in Critical Conduction Mode.

It features the fast Vsd sensing of the IR11662 Smart Rectifier Control IC with gate output drive capability of +1A/-4A. It drives 2 pcs. of SRs in parallel (100V N-ch mosfet IRF7853 in SO-8 package with very low Rdson in its class : 18 mΩ max). This had greatly simplified the overall mechanical design for not having those bulky and heavy heat sinks normally seen in high current flyback design using passive rectification.

FIGURE 1. IRAC11662-100W SCHEMATIC DIAGRAM

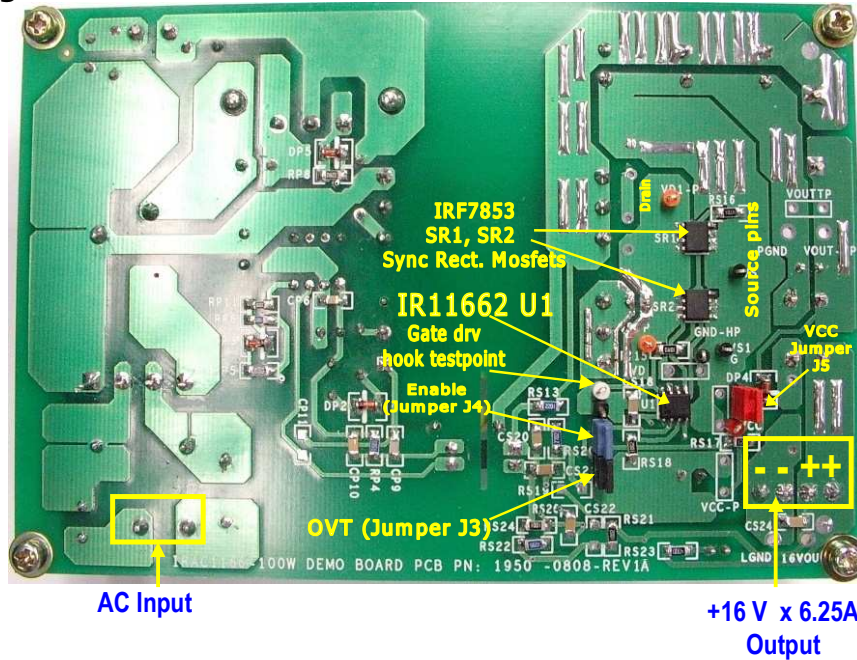


2.1 IRAC11662-100W Demo Board Pictures

Figure 2A. Top side of the IRAC11662-100W Demo Board



Figure 2B. Bottom side of the IRAC11662-100W Demo Board



2.2 PCB Layout for IRAC11662-100W

Figure 3A. Top layer etch with silkscreen print

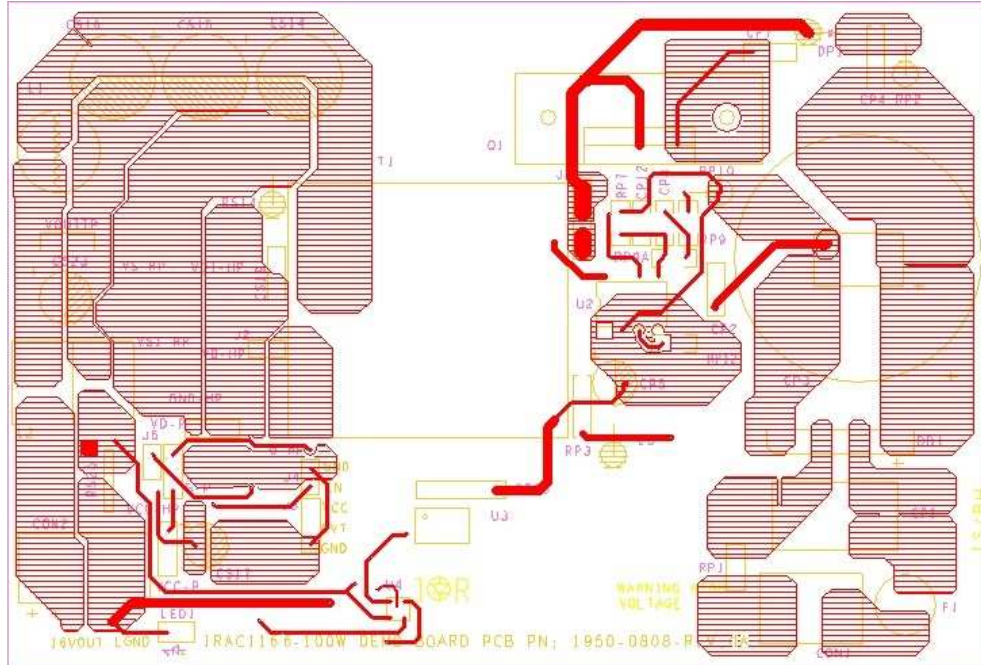
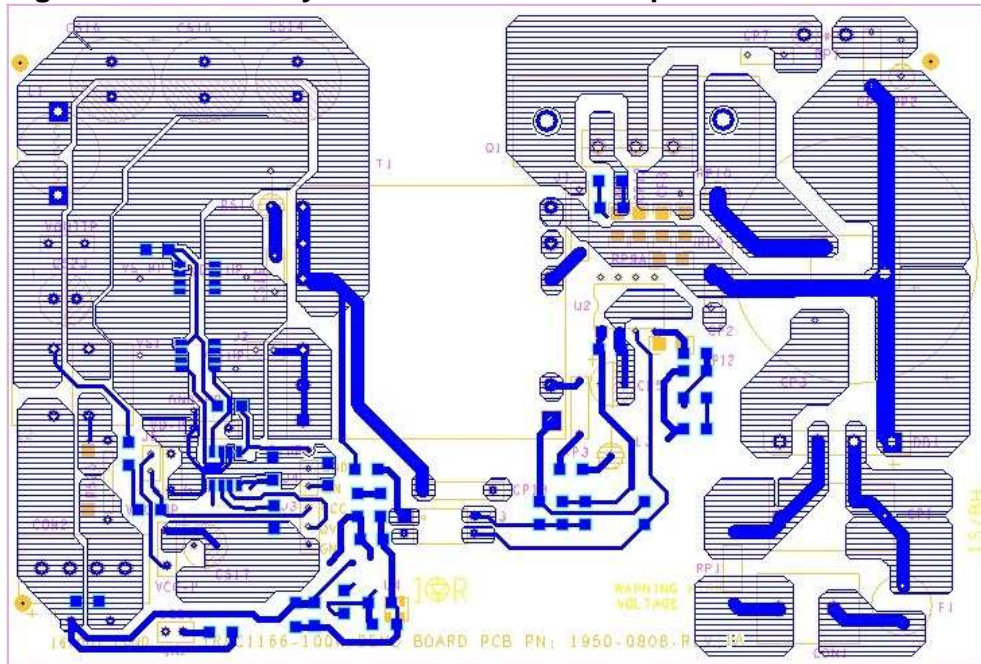


Figure 3B. Bottom layer etch with silkscreen print.



3.0 CIRCUIT DESCRIPTION

The PCB design is basically optimized as a test platform to evaluate of active rectification using Smart synchronous rectification and as well as basic features of flyback converter operating in quasi-resonant mode.

This demo board has 2-pin connector (CON1) for AC input and a time-lag type 3.5A fuse for input current overload protection. Minimum input filtering is provided (Cp1-Xcap) before AC input voltage (90-264VAC) is routed to a 6Amp-bridge rectifier (DB1).

Primary side controller (U2) basically drives the primary Mosfet Q1 to operate in Critical-Conduction mode to eliminate turn-ON switching loss thru ZVS (zero voltage switching only occurs when $nV_{sec} > V_{dcin}$) or thru LVS (low-voltage switching when $nV_{sec} < V_{dcin}$) to reduce capacitive losses of Q1 especially at high line condition. The switching frequency F_{sw} at full load varies from ~38 to ~84kHz typically from low to high input condition and falls back to minimum value (fixed ~ 6 -10kHz) to reduce input power during light load condition.

Auxiliary winding is loosely monitored by demagnetization pin4 of U2 through Dp3, Rp5 and Rp11 network that sets the OVP limit with Rp6 and Rp11 sets the over power limit of the converter.

Optocoupler U3 provides isolated output voltage feedback to the primary side. The output voltage level across load connector CON2 (+16Vo) is monitored and regulated by the V/I Secondary error amplifier U4 (AQ105 or AS4305) that also manages the output current limiting function by monitoring the voltage across the RS25-26 current sense resistors.

The power stage of the secondary is using 2-SO8 low IRF7853 synch-fets (SR) in parallel to implement the low-side synchronous rectification. In this configuration, it is simpler to derive the Vcc supply for the U1 (IR11662 SO8-IC) controller directly from the DC output Vout. Jumper J5 is used to isolate U1's Vcc from Vout so that user may easily evaluate IC's power consumption especially during standby load condition. In the absence of a sensitive low current probe, the quiescent current I_{cc} through Dp4 can be calculated from the differential voltage across the Rs17. The decoupling capacitor Cs17 and Cs18 provides additional filtering which is necessary to clean high frequency noise especially when U1 is driving several mosfets (SR1 // SR2) with high Qg parameters normally associated with high current-low voltage mosfets.

The Vd and Vs sense pins monitor the voltage (Vsd) across the sync rect mosfets and proper attention was taken during PCB routing to ensure the integrity of differential voltage Vsd. This is done by directly taking the signal Vd from the drain pins of SR1//SR2 using a dedicated trace.

Probe points as well as redundant test hook points are provided to facilitate easy probing of essential test waveforms.

4.0 TEST CONNECTION AND SETUP DIAGRAM

4.1 Recommended setup for Voltage and Current probing

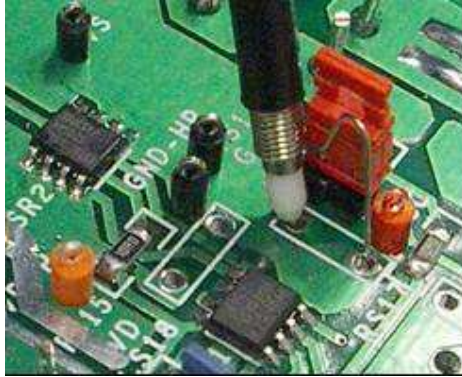


Fig. 4A Direct gate voltage probing using tip & gnd spring.



Fig. 4C Connecting O-scope probe to hook Gate drive test points.

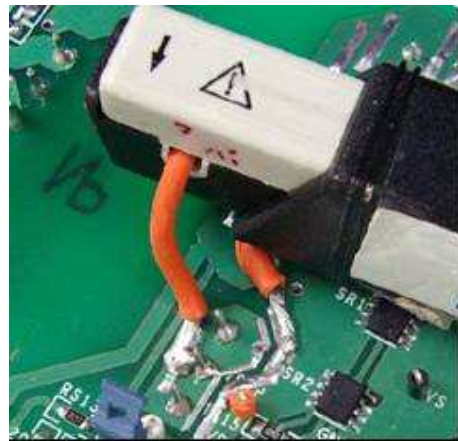


Fig. 4B Recommended probing of secondary current waveform.



Fig. 4D Recommended probing of Vout's Ripple & Noise voltage.

5.0 CIRCUIT FEATURES

5.1 OVT setting:

The Offset Voltage Threshold can be easily selected by changing the position of jumper J3 according to system mode of operation as shown on Table 1 below. Since the demo board is practically designed to operate in **Critical conduction mode**, OVT pin can be left floating or grounded to prolong the MOSFET's channel conduction period a bit compared to connecting it to Vcc. As a result, this would give the advantage of further reducing the conduction period of the MOSFET's (SR1 & SR2) body diode, thus achieving more efficient operation. Reducing the chance of having reverse current during the fast turn-off phase of the sync-fets is another strong reason for having this feature available.

Table 1

System mode of operation	OVT connected to
DCM or CrCM	Ground, $V_{TH1} = -3.5\text{mV}$
Boundary CCM	Floating, $V_{TH1} = -10.5\text{mV}$
CCM	V_{CC} , $V_{TH1} = -19.0\text{mV}$

The general observation during light load condition (~10-20% full load) is that a ~0.5 to ~1.2% efficiency improvement was seen for OVT=Gnd compared to OVT=floating. This small difference is no longer significant when the load becomes heavy for CrCM operation.

5.2 Enable setting:

The IC is enabled by default knowing that EN pin is tied internally to VCC through a resistor. Having a jumper on J4 location will connect EN pin to Gnd and will immediately disable the internal gate drive circuit of the IR11662 IC. By putting a jumper J4 in/out would help the user to quickly evaluate the effect in efficiency by investigating the change in input power as a result of having SR fets working compared to just having an ordinary passive rectification offered by the body diode(s) when the gate drive is disabled.

CAUTION :

This demo board is basically designed for evaluation of functionality of IR11662 IC. The users may disable the IC by shorting J4 EN to GND for quick testing at full load but with care should be taken. It is strongly advise not to load more than 4.6 - 6Amp with IR11662 disabled for a prolong period of time (>1min). This is to prevent damaging the MOSFET's body diode due to overheating when the load current passes through the mosfets' body diode while SRs are turned-OFF. Never power-up the unit without shorting J5.

5.3 Minimum ON Time (MOT) setting:

MOT setting is used to de-sensitize the IC from multiple change in Vsd during the turn-ON phase of SRs which is cause by the ringing of the secondary winding voltage (Vsec). MOT can be adjusted through Rs18 (according to AN1087 simplified equation $R_{MOT} = 2.5 \times 10^{10} * t_{mot}$) and is chosen to be 1.2us which is usually enough to ignore the parasitic noises at Vsd in a quasi-resonant switching converters such as this demo board.

5.4 Mosfet Selection Design Tips

Application note AN1087 has made it easy to understand the calculations required in flyback sync-rect driving circuits using IR116x series ICs. Choosing the right mosfet(s) to satisfy the performance–cost requirement of any sync rect design should be simple as well.

Voltage rating:

SRs should also follow similar equation in most flyback design as shown below:

$V_{sd} > k*[V_o + (V_{DCin_{max}} / (N_{pri}/N_{sec}))]$ where $k = 1.1$ to 1.4 as a guard band for startup stress due to leakage spike.

RdsON rating:

Generally, it is easy to meet >1% system efficiency improvement if the conduction loss of the SRs becomes twice smaller than normal passive rectification approach. This is to achieve better thermal performance especially if the designer wishes to consider not having too bulky and heavy heatsink in the design, but take note that it would still be largely dependent on the size PCB copper area allotted to the SRs. We should also consider the estimated RdsON at 25°C (normally shown in the datasheet) would be approximately ~1.8 times higher at Tj=125°C. As a rule of thumb, we will base our calculation on these assumptions to simplify the mosfet selection criteria.

For typical 100V Schottky rectifiers, Vf is around ~ 600 mV (@Tj=125°C), so in this case we should find a 100-V mosfet(s) with lower RdsON which will have a ~150mV max Vsd at rated full load current (**Io_ave**). For quick estimation of Isec_rms, designer might find Fig. 9.1 useful to quickly estimate **Isec_rms** since **Io_ave** is normally given as standard design specs.

Calculating the rms value of secondary current is easier for CrCM mode where

$$D = N \cdot V_{sec} / (N \cdot V_{sec} + V_{dcin_{min}}) \quad \text{eqn. 1}$$

$$N = N_{pri} / N_{sec}, \quad N = 31/5$$

Let $V_{sec} = 16.1$, $V_{dcmin} = 100$, $D = \sim 50\%$

$$h = V_f (\text{Schottkydiode}) / V_{sd}(\text{mosfet}) \quad \text{eqn.2}$$

$$P_{dis SR} < 1/h * V_{fdiode} * I_{o_{ave}} \quad \text{eqn.3}$$

With $h > 2$,

$$\text{Target } V_{SD(@Tj=125^\circ C)} \leq 600mV / 2$$

$$\leq \underline{300mV}$$

$$I_{sec_{rms}}^2 * R_{dsON} (@Tj=125^\circ C) \leq 300 mV * I_{o_{ave}} \quad \text{eqn.4}$$

$$R_{dsON} (@Tj=125^\circ C) = \sim 1.8 * R_{dsON} (@Tj=25^\circ C) \quad \text{eqn.5}$$

$$I_{sec_{rms}} = \frac{2I_{o_{ave}} \sqrt{(1-D)/3}}{(1-D)} \quad \text{eqn.6}$$

Combining equations 4, 5, and 6

$$R_{dsON} @Tj=25^\circ C \leq \frac{166mV[3(1-D)]}{4I_{o_{ave}}} \quad \text{eqn.7}$$

$$R_{dsON} \leq \frac{0.125 * (50\%)}{I_{o_{ave}}} = \frac{0.125 * 0.5}{6.25} = 0.010\Omega$$

$$R_{dsON} @Tj=25^\circ C \leq \underline{10 m\Omega}$$

We can use 2-SO8 mosfets (IRF7853) in parallel having equivalent RdsON (@Tj=25°C) of ~9 mΩ.

Note : $V_{sd}(@Tj=125^\circ C) < \underline{100mV}$ would yield lower RdsON and can be achieve better thermal performance but it would mean raising the parts count and cost.

6.0 TEST WAVEFORMS

6.1.1 Transient Test

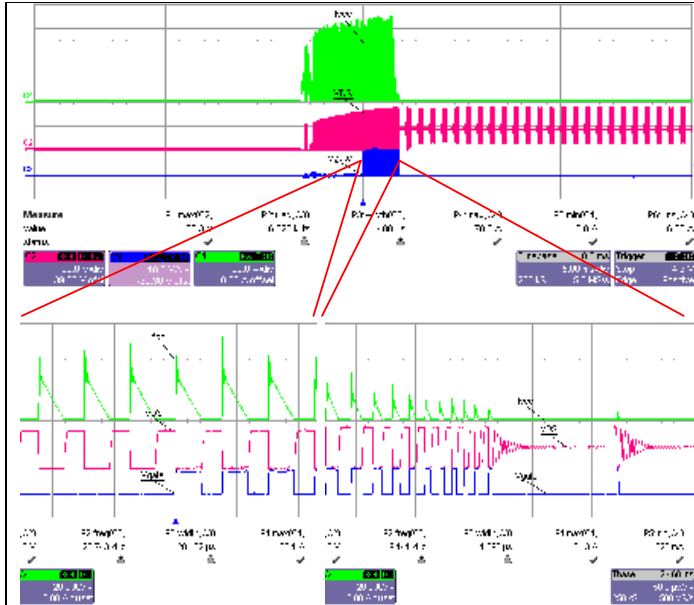


Fig 6A - 90 Vacin startup @ no load.

Ch2 : Vsd of sync rect (SR)
Ch3 : Vgate of SR1 & SR2
Ch4 : Isd

Vsd of sync rects are quite clean. IR11662 starts operation when Vcc exceeds Vcc turn on threshold. Prior to the activation of the IC, the body diodes of the sync rect mosfets act as the passive rectifiers. The VD (fsw : ~10kHz) pulses became so narrow after the output voltage stabilizes and reached the regulation at no load condition. After the output voltage getting stable, IR11662 detects the light load situation and disables gate output. (-see Fig. 6G for more details).

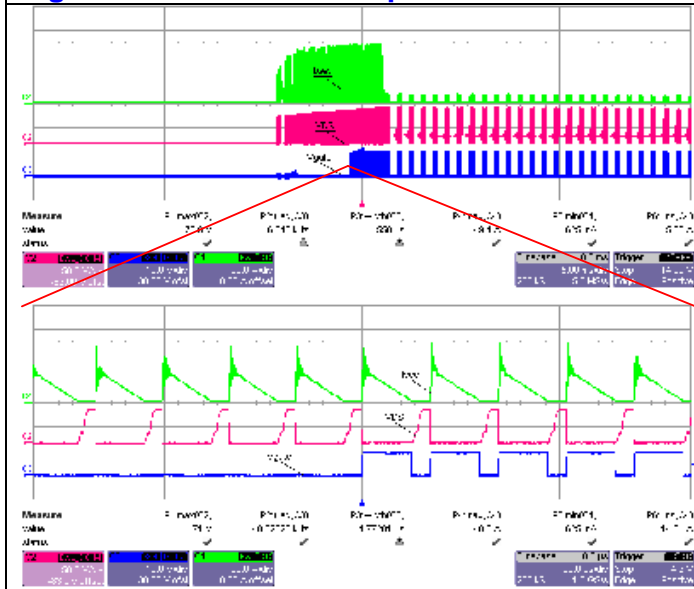


Fig 6B - 265 Vacin -startup @ no load.

Ch2 : Vsd of sync rect (SR)
Ch3 : Vgate,
Ch4 : Isd

Vsd of sync-rects is uniform and switching regularly.

Gate drive pulses become narrow at light load condition and the switching frequency decreases after the output voltage reached its regulation level.

The zoom view shows no reverse current during startup at no load.

The gate voltage of IR11662 is clamped at ~10V. The clamping circuit kicks in when Vcc voltage is approximate 13V.

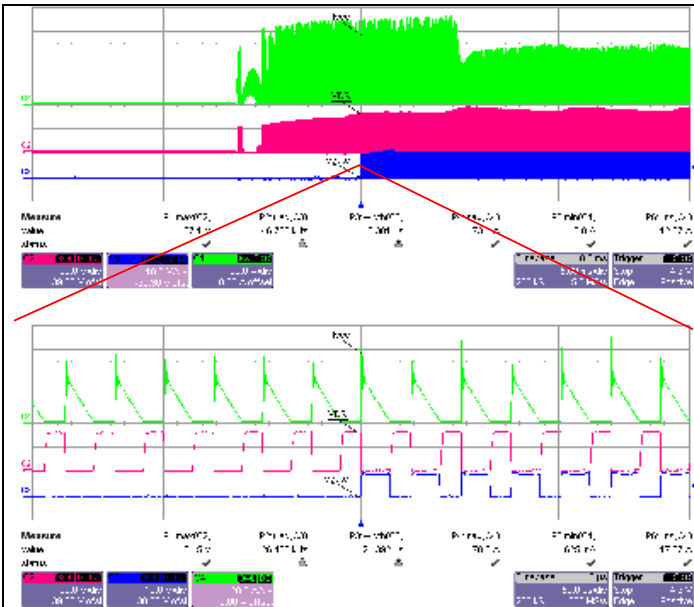


Fig 6C - 90 Vacin 100W full load startup.

Ch2 : Vsd of sync rect (SR)
Ch3 : Vgate of SR1 & SR2
Ch4 : Isd

IR11662 gate drive started ~10ms after power-up.

The zoom view shows no reverse current during startup at full load.

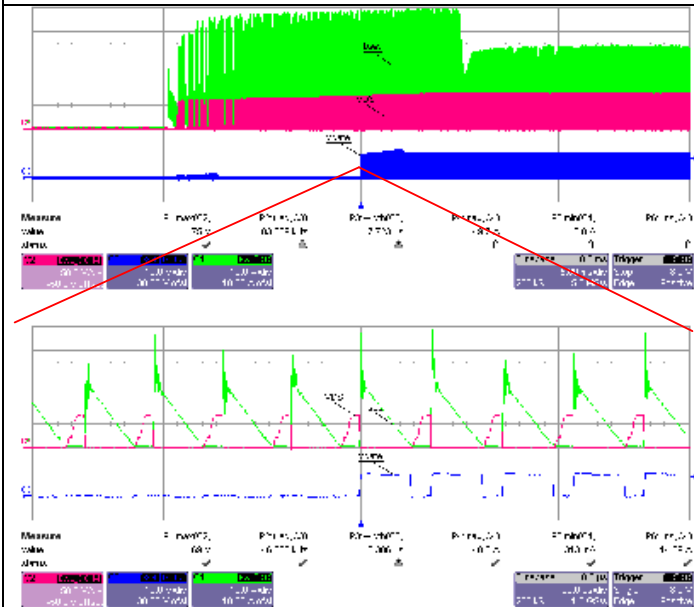


Fig 6D - 265 Vacin 100W full load startup.

Ch2 : Vsd of sync rect (SR)
Ch3 : Vgate of SR1 & SR2
Ch4 : Isd

IR11662 gate drive started ~15ms after power-up.

The zoom view shows no reverse current during startup at full load.

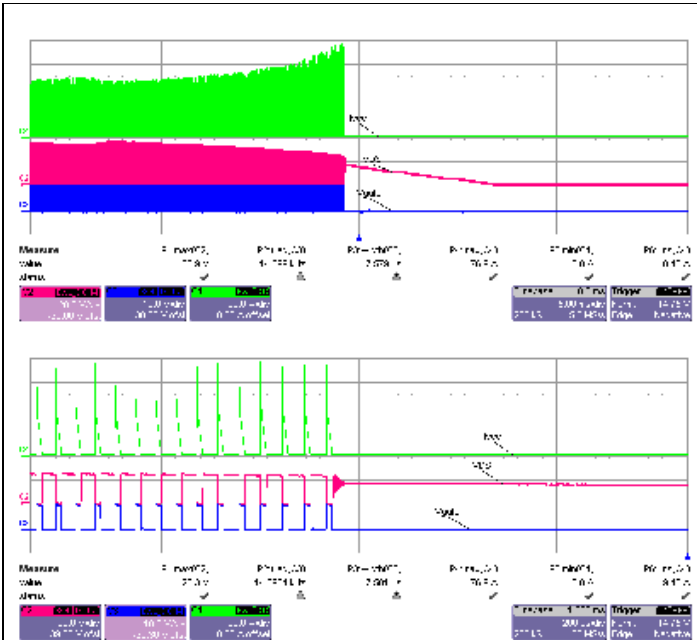


Fig 6E - Power down @ 90Vacin @ 100W full load

Ch2 : Vsd of sync rect (SR)
Ch3 : Vgate of SR1 & SR2
Ch4 : Isd

Vsd of sync-rects switching freq. drops to ~15kHz at power shutdown.

The zoom view shows no reverse current during power-off.

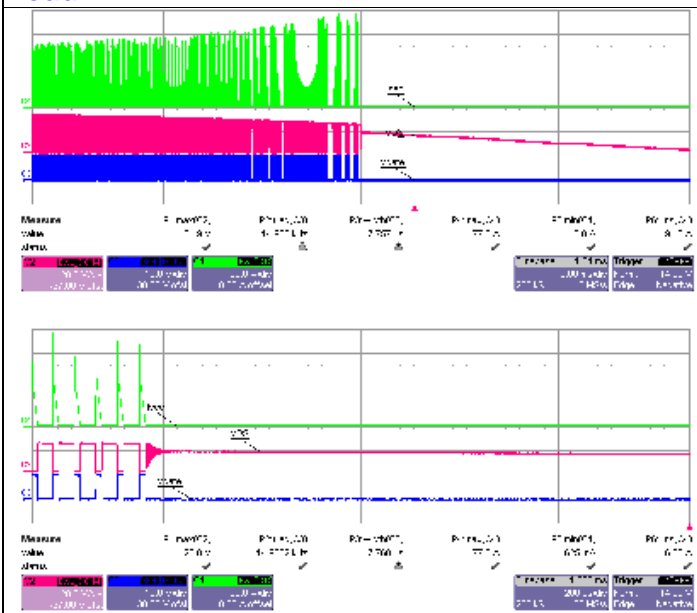


Fig 6F - Power down @ 265Vacin @ 100W full load

Ch2 : Vsd of sync rect (SR)
Ch3 : Vgate of SR1 & SR2
Ch4 : Isd

No reverse current during power-off.

6.1.2 Static Load Test

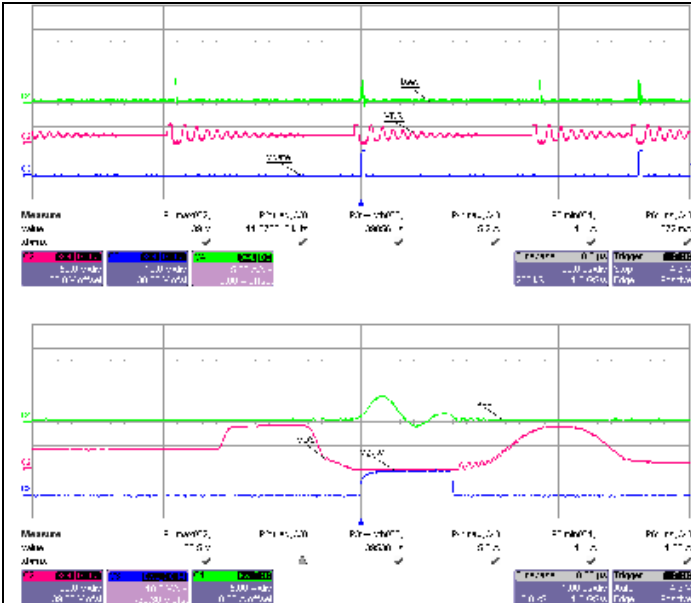


Fig. 6G - 90Vac in, 16Vout / no load

Ch2 : Vsd of sync rect (SR)
 Ch3 : Vgate of SR1 & SR2
 Ch4 : Isd

Vsd of sync-rects are switching at ~foldback freq (~12kHz DCM oper'n) at no output load condition.

Vgate became a narrow (~1.4us) pulses during no load standby operation. As the secondary current conduction time is very close to the set MOT time, IR11662 disables gate output every other cycle (cycle skipping).

The standby power at 90Vac is 0.98W with 28mA/ 460mW dummy load.

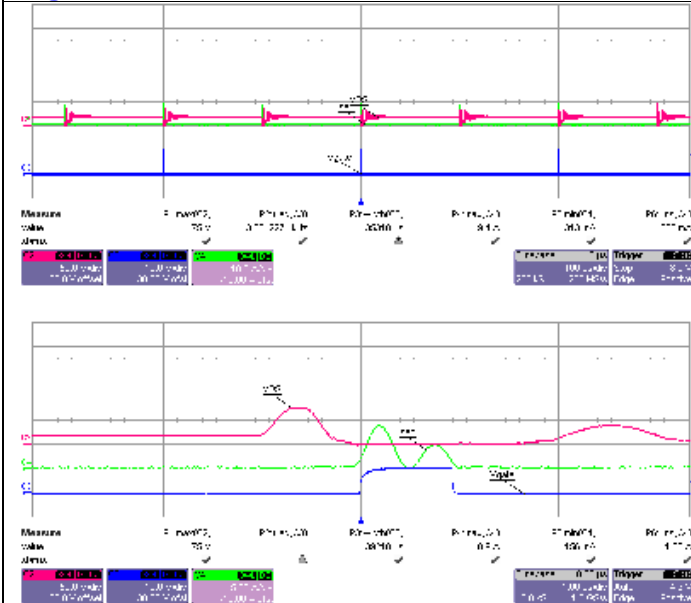


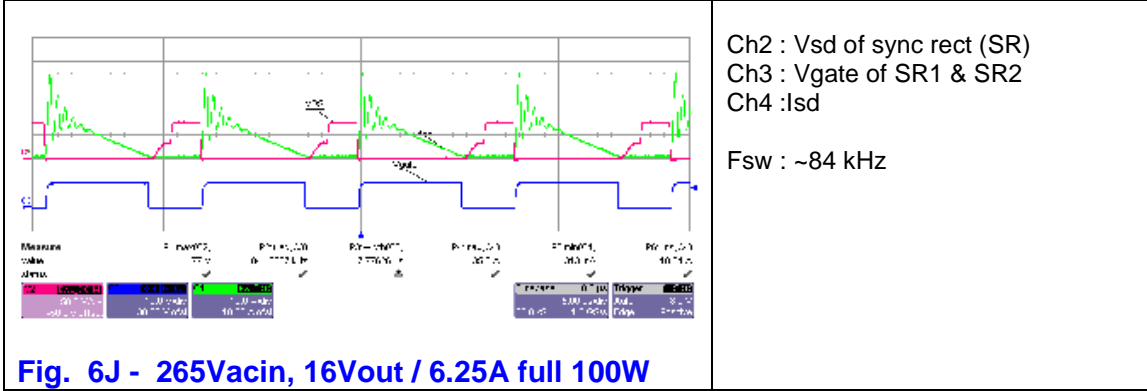
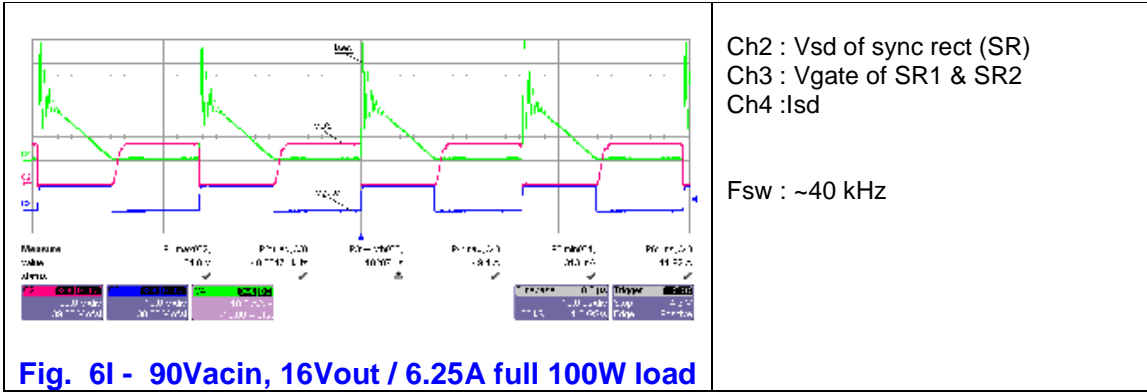
Fig. 6H - 265Vac in, 16Vout / no load

Ch2 : Vsd of sync rect (SR)
 Ch3 : Vgate of SR1 & SR2
 Ch4 : Isd

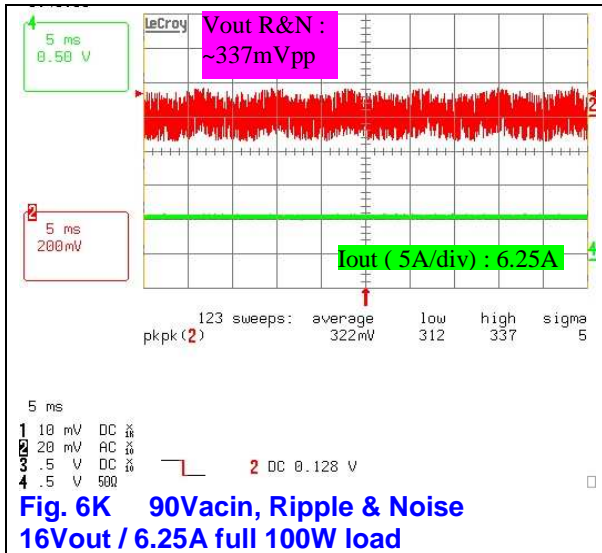
Fsw falls back to a fix low frequency around ~6kHz with gate pulse width reduce to a narrow ~1.4usec.

IR11662 has cycle skipping at high line - no load condition. This helps to reduce the gate driver losses.

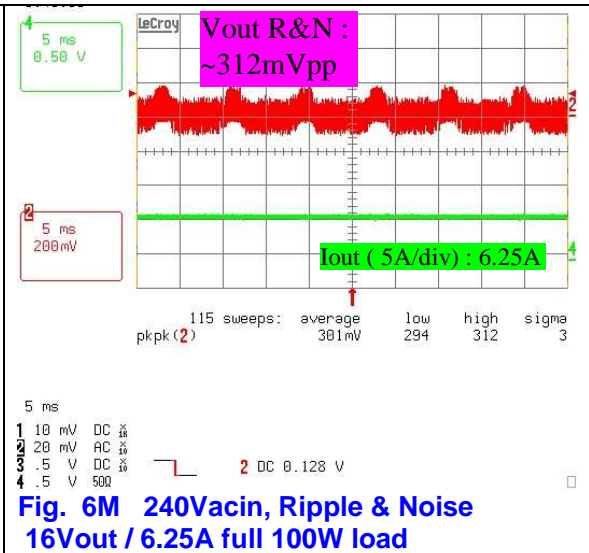
The standby power at 265Vac is 1.1W. This is under 28mA/ 460mW dummy load (Rs23 and the Green LED) condition.



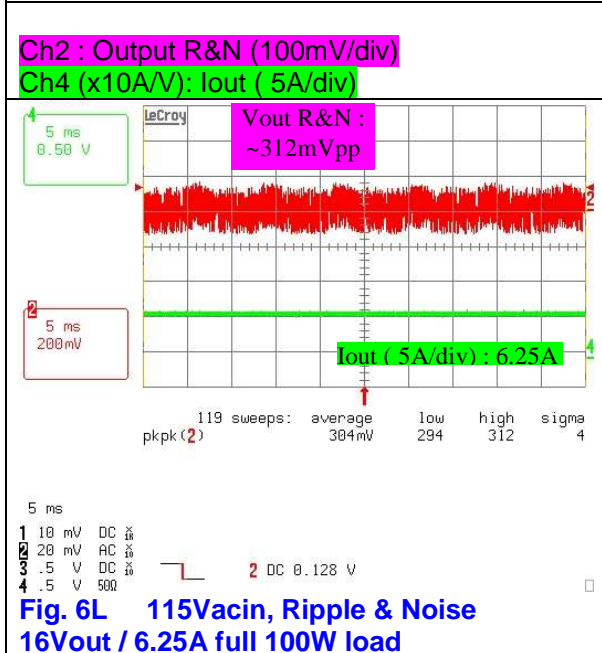
6.2 Ripple & Noise Measurement



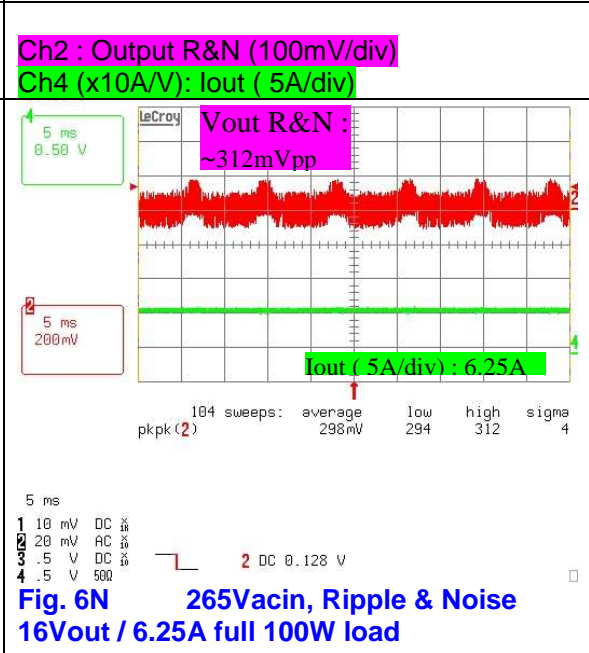
**Fig. 6K 90Vacin, Ripple & Noise
16Vout / 6.25A full 100W load**



**Fig. 6M 240Vacin, Ripple & Noise
16Vout / 6.25A full 100W load**

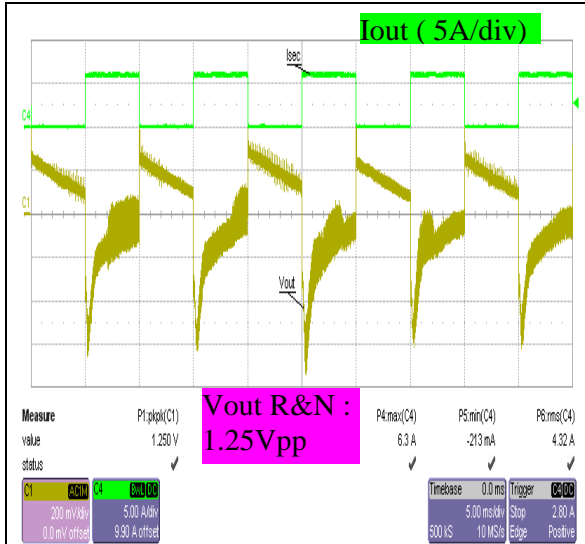


**Fig. 6L 115Vacin, Ripple & Noise
16Vout / 6.25A full 100W load**

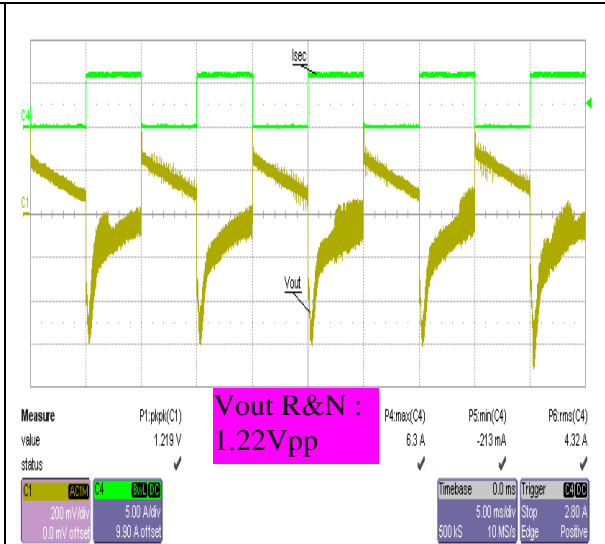


**Fig. 6N 265Vacin, Ripple & Noise
16Vout / 6.25A full 100W load**

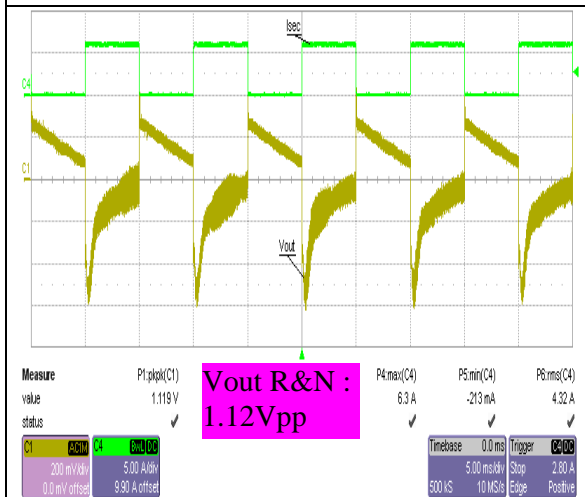
6.3 Dynamic Load Test (0 – 100% rated load, +/- 2.5A/usec)



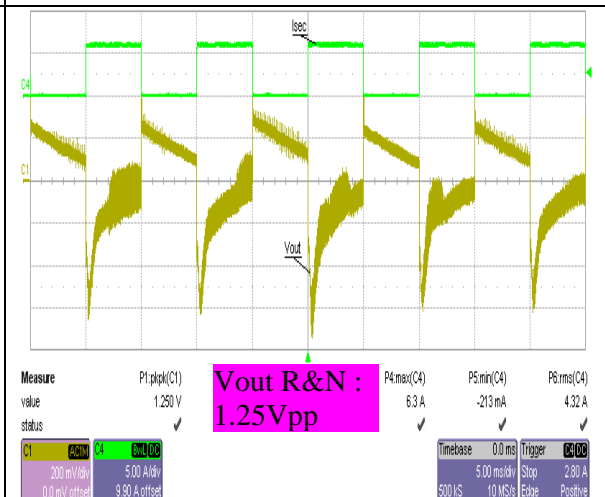
**Fig. 6O 90Vacin, Ripple & Noise
+16Vout , 6.25A 5msec, 0A 5msec**



**Fig. 5Q 240Vacin, Ripple & Noise
+16Vout , 6.25A 5msec, 0A 5msec**



**Fig. 5P 115Vacin, Ripple & Noise
+16Vout , 6.25A 5msec, 0A 5msec**



**Fig. 5R 265Vacin, Ripple & Noise
+16Vout , 6.25A 5msec, 0A 5msec**

7.0 LINE/ LOAD REGULATION TEST

7.1 IR11662 Demo Board V-I Characteristics

Vin	90	115	230	265
Iout (A)	Vout (V)	Vout (V)	Vout (V)	Vout (V)
0	16.049	16.049	16.049	16.052
1	16.052	16.053	16.058	16.063
2	16.054	16.055	16.063	16.068
3	16.053	16.054	16.061	16.07
4	16.054	16.055	16.058	16.066
5	16.054	16.056	16.059	16.064
6	16.055	16.057	16.062	16.064
6.25	16.046	16.051	16.062	16.064
6.5	16.02	16.03	16.05	16.06
6.75	14.2	14.27	14.33	14.1
7	10.29	10.34	10.4	10.36
7.25	Bounce	Bounce	Bounce	Bounce

Table 2. V-I Characteristics

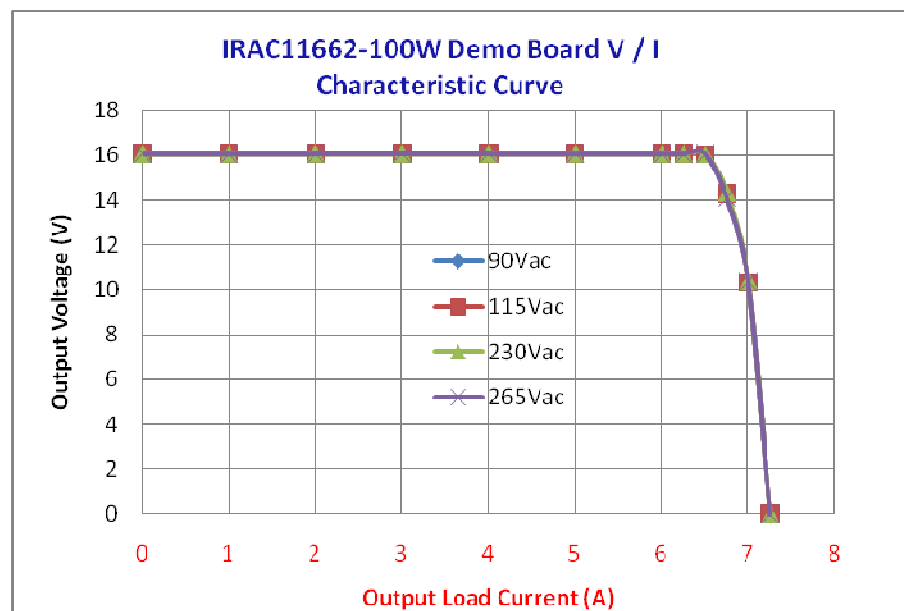


Figure 7.1. Output Voltage vs. Load Current Characteristic Curve

7.2 System Efficiency Test

Table 3

VinAC	Vout V	Iout (A)	Pout (W)	Pin (W)	Efficiency
90	16.046	6.244	100.2	117.3	85.41%
115	16.051	6.244	100.2	115.5	86.77%
230	16.062	6.244	100.3	115	87.21%
265	16.064	6.244	100.3	116	86.47%

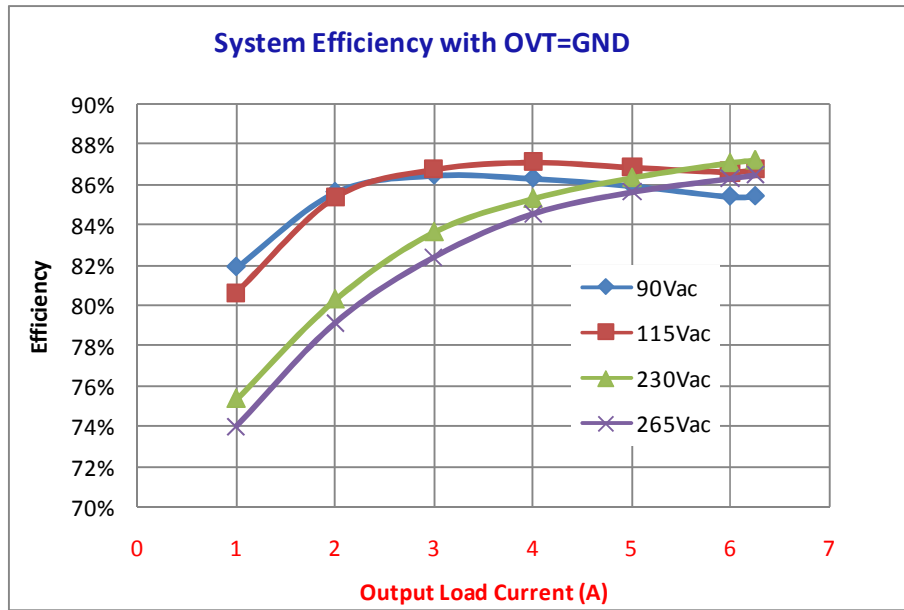


Fig. 7.2A System Efficiency with OVT = Gnd

7.3 Thermal Verification

Table 4

IRAC11662-100W	90VACin	265VACin
Ambient Temp	26	26
IR11662 (SO-8 IC)	73	70
SR1 (IRF7853 SO8 FET)	95	84
SR2 (IRF7853 SO8 FET)	96	85
Q1 (IRF22N60K)	58	65
DP1 (UF5407) Snubber diode	62.5	69.5
330uF/400V MXR Bulk Ecap	50	50
Power transformer (PQ3535)	75.5	76
Input bridge rectifier	67	49
Pin (W)	117.3	116
Vout (A)	16.05	16.06
Iout (A)	6.25	6.25
Efficiency	85.5%	86.5%

Note : All case temperature in °C.

8.0 Summary :

This demo board showcases the performance of IR11662 SmartRectifier Control IC to drive mosfets (as synchronous rectifiers) by simple fast-rate direct-voltage-sensing technique. It also featured the flexibility of the IC to cope with different current conduction modes of flyback converter designs.

The low-side synchronous rectification is fully demonstrated in this demo board, which operates in variable frequency critical conduction mode (VF-CrCM). This configuration has lead to achieve better efficiency and a much simpler overall system design normally required in single output flyback high current applications such those use in laptop power adaptors.

This 100W demo board has shown the efficiency improvement using low voltage SO8 mosfets – replacing the traditional Schottky rectifiers - has brought a string of advantages such as avoiding the use of heavy heat sinks and simple gate drive circuit for the synchronous mosfets. This design simplification has resulted to saving in PCB area due to reduction of part counts and elimination of bulky heat sink. IR11662 automatically disables or skips gate output at no load condition thus minimizes the standby power losses.

9.1 Transformer turns ratio, Duty Cycle and Secondary Current Relationship

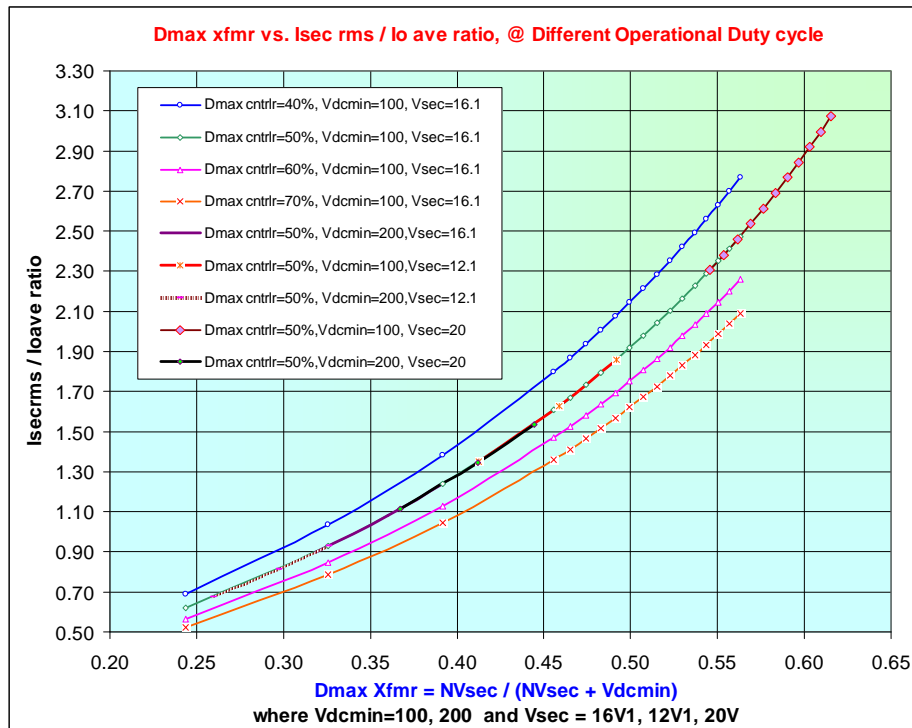


Fig. 9.1 Graphical estimation chart for $I_{sec\ rms} / I_{o\ ave}$

9.2 IRAC11662-100W +16V SR Demo Board Power Transformer Specification

Winding W1 : 15 turns 2 x AWG#20
 Winding W2 : 5 turns 3 x TIW (0.55 mm)
 Winding W3 : 5 turns 3 x TIW (0.55 mm)
 Winding W4 : 5 turns AWG#30
 Winding W5 : 5 turns 3 x TIW (0.55 mm)
 Winding W6 : 16 turns 2 x AWG#20
 Core type : PQ3535
 Ferrite material : PC44 TDK / Nicera equivalent

Lpri : 250uH +/-15% (pin 6-4)
 Finishing : Dip varnish / vacuum

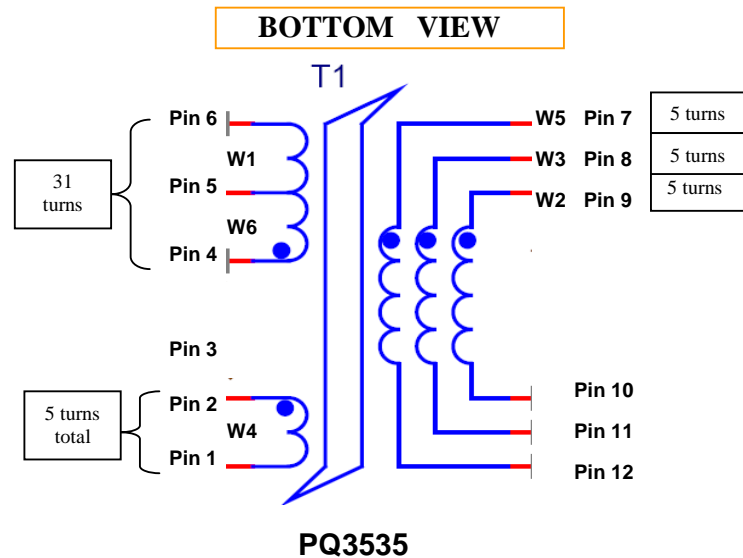


Fig. 9.2 Power transformer Winding Termination Diagram

Note : TIW = triple insulated wire

10.0 IRAC11662-100W +16V Demo Board Bill of Material (BOM)

Note: TH = Through-hole Date : 8-Mar-2010

Item #	Qty.	Value	Part Ref.	Description	Manuf. PN.
1	1	2-PIN	CON1	2 way connector (TH)	PN: 5417 or List No. : 39-26-3030
2	1	4-PIN	CON2	4 way connector (TH)	PN: 5417 or List No. : 39-26-3040
3	1	220NF/275V	CP1	KNB1560 0.22UF 10% 275 L30 R15 (TH)	KNB1560 0.22UF 10% 275 L30 R15
4	1	4NF7/1KV	CP2	CAPACITOR, 4.7NF 1000V (TH)	DEBF33A472ZC1B(Murata)
5	1	330UF/400V	CP3	CAPACITOR, 330UF 400V (TH)	400MXR330M35X35 (Rubycon) or EET-ED2G331EA - (Panasonic)
6	1	4NF7/1KV	CP4	CAPACITOR, 4.7NF 1kV (TH)	DEBF33A472ZC1B (Murata)
7	1	100UF/35V	CP5	CAPACITOR, 100UF 35V (TH)	UPL1V101MPH NICHICON
8	1	0.1UF	CP6	CAPACITOR, 1206 100 NF 50V	12065C104KAT00J
9		UNSTUFFED	CP7	UNSTUFFED	
10	1	0.22UF	CP8	CAPACITOR, 1206 220NF 50V	12065G224ZAT2A (AVX)
11	1	22PF	CP9	CAPACITOR, 1206 22PF 50V	12061A220JAT2A (AVX)
12	1	10NF	CP10	CAPACITOR, 1206 10NF 50V	12065G103ZAT2A (AVX)
13	1	4N7F	CP11	CAPACITOR, 1206 4.7NF 50V	12065C471KAT2A (AVX)
14	1	22PF	CP12	CAPACITOR, 1206 22PF 50V	12061A220JAT2A (AVX)
15	1	1N5	CP13	CAPACITOR, X1/Y1 1.5NF (TH)	DE1E3KX152MA5B (Murata)
16	1	1000UF/25V	CS14, CS15	CAPACITOR, 1000UF 25V (TH)	25ZL1000M12.5X20 (Rubycon)
17	1	1500UF/25V	CS16	CAPACITOR, 1500UF 25V (TH)	25ZL1500M12.5X25 (Rubycon)
18	1	22UF/35V	CS17	CAPACITOR, 22UF 50V (TH)	50ZL22M5X11 (Rubycon)
19	1	100NF	CS18, CS24	CAPACITOR, 1206 100NF 50V	12065C104KAT00J (AVX)
20		UNSTUFFED	CS19	UNSTUFFED	
21	1	47NF	CS20	CAPACITOR, 1206 47NF 50V	12065C473KAT2A (AVX)
22	2	10NF	CS21, CS22, CS25	CAPACITOR, 1206 10NF 50V	12065C103KAT2A (AVX)
23	1	820UF/25V	CS23	CAPACITOR 820UF, 25V (TH)	EEUFC1E821.
24	1	6GBU06	DB1	6-Amp 800V Bridge rectifier diode (TH)	6GBU06 -(General Semiconductor)
25	1	1n5407	DP1	DIODE, 3A 800V (TH)	1N5407 (General Semiconductor)
26	1	BAV103/200V	DP2	DIODE, SWITCHING SOD-80C	Philips BAV103
27	3	LS4148	DP3, DP4, DS5	DIODE, QUADRO-MELF	LS4148 (VISHAY)
28	1	T3.15A/250V	F1	FUSE, TR5 ANTISURGE 3.15A, (TH)	19372K 3.15A.
29	1	Test hook point	GND,G	TERMINAL, PCB Raised Loop Black (TH)	200-203 (W HUGHES)
30	1	Test hook point	Gate Drv	TERMINAL, PCB Raised Loop White (TH)	200-201 (W HUGHES)
31	1	Wire Jumper	J1	Jumper wire 0.7 diameter, 19 mm (TH)	
32	1	Wire Jumper	J2	Jumper wire 0.7 diameter, 11mm (TH)	
33	1	JUMPER1	J3	Three way jumper (TH)	M22F2010305 (HARWIN)
34	2	JUMPER1	J4, J5	Two-way jumper (TH)	M22-2010205 (HARWIN)
35	1		for J3	Jumper Head (blue)	M22-1910005 (HARWIN)
36	1		for J4	Jumper Head (Black)	M22-1900005 (HARWIN)
37	1		for J5	Jumper Head (Red)	M22F19200005 (HARWIN)
38	1	1uH	L1	High current Ferrite Rod Inductor- (TH) prime	PG0203 -Pulse Electronics or 019-4698-00R - Precision Inc.
39	1	40uH	L2	Common mode choke -TH	019-4685-00R - Precision Inc.
40	1	10uH	L3	Ferrite core inductor, axial (TH)	B78108-S1103-K -EPCOS

41	1	LED	LED1	LED Green - TH	L-1413GDT
42	1	IRFP22N60K	Q1	TO-247 600V 22Amp N-ch Mosfet (TH)	IRFP22N60KPBF- VISHAY
43	1	10R	RP1	NTC Thermistor 10ohm 3Amp (TH)	B57235S100M - EPCOS
44	1	47K 2W	RP2	RESISTOR, 2W 5% 47K - (TH)	MCF 2W 47K
45	1	22R	RP3	RESISTOR, 0.25W 5% 22R (TH)	MCF 0.25W 22R.
46	1	3k3	RP4	RESISTOR, 1206 3K3	MC 0.125W 1206 1% 3K3
47	1	0R	RP5	RESISTOR, 1206 0R 5%	MC 0.125W 1206 0R
48	1	910K	RP6	RESISTOR, 1206 910K	MC 0.125W 1206 5% 910K
49	1	5.1k	RP7	RESISTOR, 1206 5.1K;	MC 0.125W 1206 1% 5.1K
50	1	22R	RP8	RESISTOR, 1206 22R	MC 0.125W 1206 5% 22R
51	3	1K	RP9, RP12, RS22	RESISTOR, 1206 1K	MC 0.125W 1206 1% 1K
52	1	12K	RP9A	RESISTOR, 1206 12K	MC 0.125W 1206 5% 12K
53	1	0R1	RP10	RESISTOR, WW 3W 5% 0R1 (TH)	WELWYN W210R1J1
54	1	280K	RP11	RESISTOR, RC12H 1206 280K	MC 0.125W 1206 5% 280K
55	1	2K2	RS13	RESISTOR, 1206 2K2	MC 0.125W 1206 5% 2K2.
56			RS14, RS26	UNSTUFFED	
57	2	10R	RS15, RS17	RESISTOR, 1206 10R	MC 0.125W 1206 5% 10R
58	1	4K7	RS16	RESISTOR, 1206 4K7	MC 0.125W 1206 5% 4K7
59	1	33K	RS18	RESISTOR, 1206 33K	MC 0.125W 1206 5% 33K
60	1	47K	RS20	RESISTOR, 1206 47K	MC 0.125W 1206 1% 47K
61	1	10K	RS21	RESISTOR, 1206 10K	MC 0.125W 1206 1% 10K
62	1	470R	RS23	RESISTOR, RC02H 1206 470R	RC-02H-470R-1P5.
63	1	5.6k	RS24	RESISTOR, 1206 5.6K;	MC 0.125W 1206 1% 5.6K
64	1	30m	RS25	RESISTOR, SMD 1% 0R030	OARS1 - R030FI.
65	2	IRF7853	SR1, SR2	SO-8 N-ch 100V 18mohm MOSFET	IR
66	1	PQ3535	T1	PQ3535 100W Flyback Power Transformer (TH)	019-4563-00 Rev 01 -Precision Inc.
67	1	IR11662	U1	SO-8 Flyback Sync Rectifier Smart Controller	IR
68	1	TEA1507	U2	GreenChip™ II SMPS control IC DIP8 (TH)	TEA1507 - NXP
69	1	SFH615A2	U3	SFH615A2 DIP 4 option G Optocoupler (TH)	SFH615A-2 -Vishay (Infineon)
70	1	AS4305 or AQ105	U4	SOT23-5 Secondary V-I Error amplifier	Siliconlink or Acutechnology
71	1	Test hook point	VCC-HP	TERMINAL, PCB Raised Loop - Red (TH)	200-207 - W HUGHES
72	2	Test hook point	VD-HP, VD1-HP	TERMINAL, PCB Raised Loop- Yellow (TH)	200-202 - W HUGHES
73	1	Test hook point	VS, VS1	TERMINAL, PCB Raised Loop BLACK (TH)	200-203 - W HUGHES
74	1	Pri - Heatsink		10.4DegC/W, Black anodized extruded heat sink - radial fins & notched base and solderable pins	531102B02500G -Aavid Thermalloy HS191-ND -DIGI-KEY
75	4	Screw + washer		SCREW with washer M3X6 P=.5	SEM02030006FA (NETTLEFOLDS)
76	1	Screw		M3x12 mm , For Primary heat sink	MB04030012007FA (NETTLEFOLDS)
77	2	Spring Washers		M3 1mm thick, For Primary heat sink	WS21030081FA (unbranded)
78	1	Nut		HEX NUT M3X0.5X1.8	NC01030081FA (unbranded)
79	1	Insulator	for Q1 (TO247)	Silpad K-10 or K-4, 25.5mm x 19.1mm (0.2 - 0.4 degCin ² /W)	0900 000 5350 (HARTING Bergquist)
80	4	Nylon Standoff	TRANSIPILLA R, HEX STYLE 3 M3X38;	Depth, thread:4.5mm; Diameter, External:7mm; Head type:Hexagonal; Height, spacer:38mm; Length / Height, external:38mm; Thread size:M3	SCHURTER- 9633.83
81	1	PCB		1.6mm thick 2-sided 2 oz, UL rated 94V-0 PCB	