

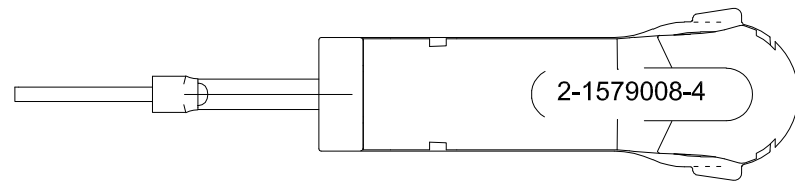
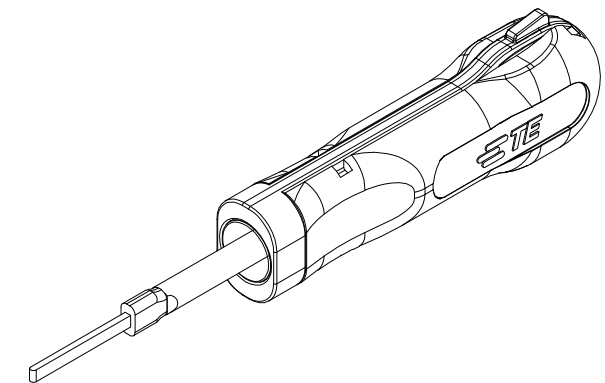
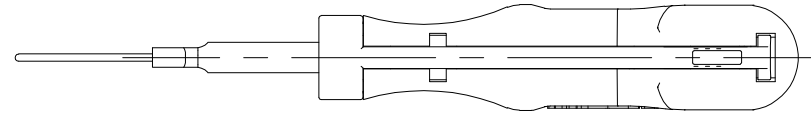
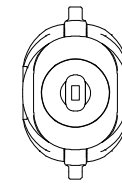
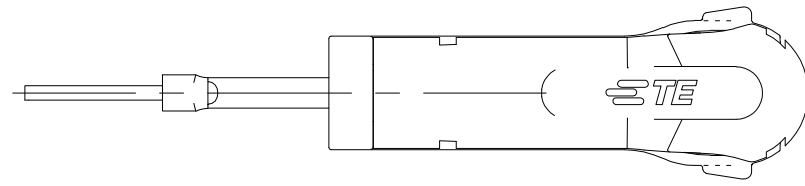

THIS DRAWING IS UNPUBLISHED.

RELEASED FOR PUBLICATION

© COPYRIGHT - BY TYCO ELECTRONICS CORPORATION. ALL INTERNATIONAL RIGHTS RESERVED.

LOC		DIST		REVISIONS			
P	LTR	DESCRIPTION		DATE	DWN	APVD	
	A1	ECR-17-009722		04JUL17	MG	BM	



THIS DRAWING IS A CONTROLLED DOCUMENT.		DWN	06.11.2006		 <b>TE Connectivity</b>				
DIMENSIONS: mm		CHK	-						
		TOLERANCES UNLESS OTHERWISE SPECIFIED:		NAME					
		0 PLC	± -	EXTRACTION TOOL					
MATERIAL		1 PLC	± -	ENTRIEGELUNGSWERKZEUG					
		2 PLC	± -	RESTRICTED TO					
		3 PLC	± -	SIZE	CAGE CODE	DRAWING NO	-		
		4 PLC	± -	A3	00779	C-2-1579008-4			
FINISH		WEIGHT		SCALE		SHEET		REV	
		0.016 kg		1:1		1 OF 1		A1	
CUSTOMER DRAWING									