

# OPTICALLY ISOLATED ERROR AMPLIFIER

## FOD2711

### DESCRIPTION

The FOD2711 Optically Isolated Amplifier consists of the popular RC431A precision programmable shunt reference and an optocoupler. The optocoupler is a gallium arsenide (GaAs) light emitting diode optically coupled to a silicon phototransistor. The reference voltage tolerance is 1%. The current transfer ratio (CTR) ranges from 100% to 200%.

It is primarily intended for use as the error amplifier/reference voltage/optocoupler function in isolated ac to dc power supplies and dc/dc converters.

When using the FOD2711, power supply designers can reduce the component count and save space in tightly packaged designs. The tight tolerance reference eliminates the need for adjustments in many applications.

The device comes in a 8-pin dip white package.

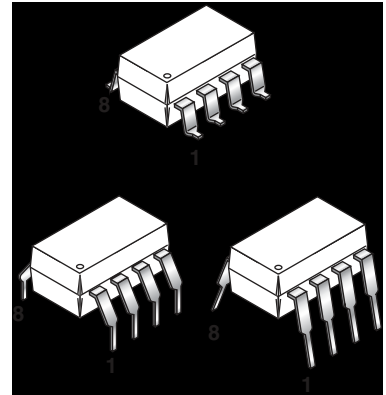

### FEATURES

- Optocoupler, precision reference and error amplifier in single package
- 1.240V  $\pm$  1% reference
- CTR 100% to 200%
- 5,000V RMS isolation
- UL approval E90700, Volume 2  
CSA approval 1296837  
VDE approval 40002463  
BSI approval 8702, 8703

### APPLICATIONS

- Power supplies regulation
- DC to DC converters

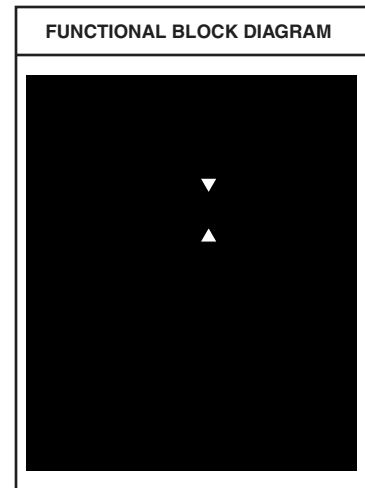

### PIN DEFINITIONS

Pin Number	Pin Name	Pin function description
1	NC	Not connected
2	C	Phototransistor Collector
3	E	Phototransistor Emitter
4	NC	Not connected
5	GND	Ground
6	COMP	Error Amplifier Compensation. This pin is the output of the error amplifier. *
7	FB	Voltage Feedback. This pin is the inverting input to the error amplifier
8	LED	Anode LED. This pin is the input to the light emitting diode.

\* The compensation network must be attached between pins 6 and 7.

# OPTICALLY ISOLATED ERROR AMPLIFIER

## FOD2711

### TYPICAL APPLICATION

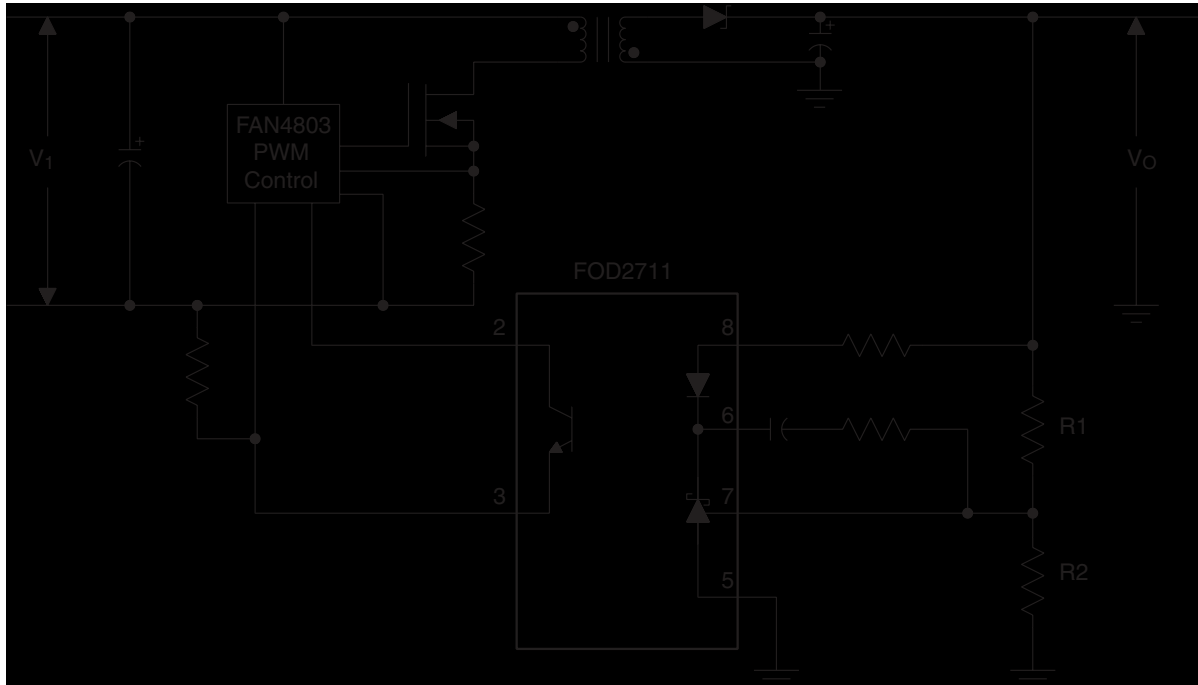

### ABSOLUTE MAXIMUM RATINGS (T<sub>A</sub> = 25°C Unless otherwise specified.)

Parameter	Symbol	Value	Units
Storage Temperature	T <sub>STG</sub>	-55 to +125	°C
Operating Temperature	T <sub>OPR</sub>	-40 to +85	°C
Lead Solder Temperature	T <sub>SOL</sub>	260 for 10 sec.	°C
Input Voltage	V <sub>LED</sub>	13.2	V
Input DC Current	I <sub>LED</sub>	20	mA
Collector-Emitter Voltage	V <sub>CEO</sub>	30	V
Emitter-Collector Voltage	V <sub>ECO</sub>	7	V
Collector Current	I <sub>C</sub>	50	mA
Input Power Dissipation (note 1)	PD1	145	mW
Transistor Power Dissipation (note 2)	PD2	85	mW
Total Power Dissipation (note 3)	PD3	145	mW

#### Notes

1. Derate linearly from 25°C at a rate of 2.42 mW/°C
2. Derate linearly from 25°C at a rate of 1.42 mW/°C.
3. Derate linearly from 25°C at a rate of 2.42 mW/°C.
4. Functional operation under these conditions is not implied. Permanent damage may occur if the device is subjected to conditions outside these ratings.

# OPTICALLY ISOLATED ERROR AMPLIFIER

## FOD2711

### ELECTRICAL CHARACTERISTICS (T<sub>A</sub> = 25°C Unless otherwise specified.)

#### INPUT CHARACTERISTICS

Parameter	Test Conditions	Symbol	Min	Typ**	Max	Unit
LED forward voltage	(I <sub>LED</sub> = 10 mA, V <sub>COMP</sub> = V <sub>FB</sub> )(Fig.1)	V <sub>F</sub>			1.5	V
Reference voltage (-40 to +85°C)	(V <sub>COMP</sub> = V <sub>FB</sub> , I <sub>LED</sub> = 10 mA (Fig.1))	V <sub>REF</sub>	1.221		1.259	V
(25°C)			1.228	1.240	1.252	
Deviation of V <sub>REF</sub> over temperature - See Note 1	(T <sub>A</sub> = -40 to +85°C)	V <sub>REF (DEV)</sub>		4	12	mV
Ratio of Vref variation to the output of the error amplifier	(I <sub>LED</sub> = 10 mA, V <sub>COMP</sub> = V <sub>REF</sub> to 12 V) (Fig.2)	$\frac{\Delta V_{REF}}{\Delta V_{COMP}}$		-1.5	-2.7	mV/V
Feedback input current	(I <sub>LED</sub> = 10 mA, R1 = 10 kΩ) (Fig.3)	I <sub>REF</sub>		0.15	0.5	μA
Deviation of I <sub>REF</sub> over temperature - See Note 1	(T <sub>A</sub> = -40 to +85°C)	I <sub>REF (DEV)</sub>		0.15	0.3	μA
Minimum drive current	(V <sub>COMP</sub> = V <sub>FB</sub> ) (Fig.1)	I <sub>LED (MIN)</sub>		55	80	μA
Off-state error amplifier current	(V <sub>LED</sub> = 13.2 V, V <sub>FB</sub> = 0) (Fig.4)	I <sub>(OFF)</sub>		0.001	0.1	μA
Error amplifier output impedance - See Note 2	(V <sub>COMP</sub> = V <sub>FB</sub> , I <sub>LED</sub> = 0.1 mA to 15 mA, f < 1 KHZ)	Z <sub>OUT</sub>		0.25		Ohm

1. The deviation parameters V<sub>REF(DEV)</sub> and I<sub>REF(DEV)</sub> are defined as the differences between the maximum and minimum values obtained over the rated temperature range. The average full-range temperature coefficient of the reference input voltage, ΔV<sub>REF</sub> is defined as:

$$|\Delta V_{REF}|(\text{ppm}/^{\circ}\text{C}) = \frac{\{V_{REF(DEV)}/V_{REF}(T_A = 25^{\circ}\text{C})\} \times 10^6}{\Delta T_A}$$

where ΔT<sub>A</sub> is the rated operating free-air temperature range of the device.

2. The dynamic impedance is defined as |Z<sub>OUT</sub>| = ΔV<sub>COMP</sub>/ΔI<sub>LED</sub>. When the device is operating with two external resistors (see Figure 2), the total dynamic impedance of the circuit is given by:

$$|Z_{OUT, TOT}| = \frac{\Delta V}{\Delta I} \approx |Z_{OUT}| \times \left[ 1 + \frac{R1}{R2} \right]$$

# OPTICALLY ISOLATED ERROR AMPLIFIER

## FOD2711

### OUTPUT CHARACTERISTICS ( $T_A = 25^\circ\text{C}$ Unless otherwise specified.)

Parameter	Test Conditions	Symbol	Min	Typ	Max	Unit
Collector dark current	( $V_{CE} = 10\text{ V}$ ) (Fig. 5)	$I_{CEO}$			50	nA
Emitter-collector voltage breakdown	( $I_E = 100\ \mu\text{A}$ )	$BV_{ECO}$	7			V
Collector-emitter voltage breakdown	( $I_C = 1.0\text{mA}$ )	$BV_{CEO}$	70			V

### TRANSFER CHARACTERISTICS ( $T_A = 25^\circ\text{C}$ Unless otherwise specified.)

Parameter	Test Conditions	Symbol	Min	Typ	Max	Unit
Current transfer ratio	( $I_{LED} = 10\text{ mA}$ , $V_{COMP} = V_{FB}$ , $V_{CE} = 5\text{ V}$ ) (Fig. 6)	CTR	100		200	%
Collector-emitter saturation voltage	( $I_{LED} = 10\text{ mA}$ , $V_{COMP} = V_{FB}$ , $I_C = 2.5\text{ mA}$ ) (Fig. 6)	$V_{CE(SAT)}$			0.4	V

### ISOLATION CHARACTERISTICS ( $T_A = 25^\circ\text{C}$ Unless otherwise specified.)

Parameter	Test Conditions	Symbol	Min	Typ	Max	Unit
Input-output insulation leakage current	( $RH = 45\%$ , $T_A = 25^\circ\text{C}$ , $t = 5\text{ s}$ , $V_{I-O} = 3000\text{ VDC}$ ) (note. 1)	$I_{I-O}$			1.0	$\mu\text{A}$
Withstand insulation voltage	( $RH \leq 50\%$ , $T_A = 25^\circ\text{C}$ , $t = 1\text{ min}$ ) (note 1)	$V_{ISO}$	5000			Vrms
Resistance (input to output)	$V_{I-O} = 500\text{ VDC}$ (note. 1)	$R_{I-O}$		$10^{12}$		Ohm

### SWITCHING CHARACTERISTICS ( $T_A = 25^\circ\text{C}$ Unless otherwise specified.)

Parameter	Test Conditions	Symbol	Min	Typ	Max	Unit
Bandwidth	(Fig. 7)	$B_W$		10		kHZ
Common mode transient immunity at output high	( $I_{LED} = 0\text{ mA}$ , $ V_{cm}  = 10\text{ V}_{PP}$ , $RL = 2.2\text{ k}\Omega$ ) (Fig. 8) (note 2)	$ CMH $		1.0		$\text{kV}/\mu\text{s}$
Common mode transient immunity at output low	( $I_{LED} = 10\text{ mA}$ , $ V_{cm}  = 10\text{ V}_{PP}$ , $RL = 2.2\text{ k}\Omega$ ) (Fig. 8) (note 2)	$ CML $		1.0		$\text{kV}/\mu\text{s}$

#### Notes

- Device is considered as a two terminal device: Pins 1, 2, 3 and 4 are shorted together and Pins 5, 6, 7 and 8 are shorted together.
- Common mode transient immunity at output high is the maximum tolerable (positive)  $dV_{cm}/dt$  on the leading edge of the common mode impulse signal,  $V_{cm}$ , to assure that the output will remain high. Common mode transient immunity at output low is the maximum tolerable (negative)  $dV_{cm}/dt$  on the trailing edge of the common pulse signal,  $V_{cm}$ , to assure that the output will remain low.

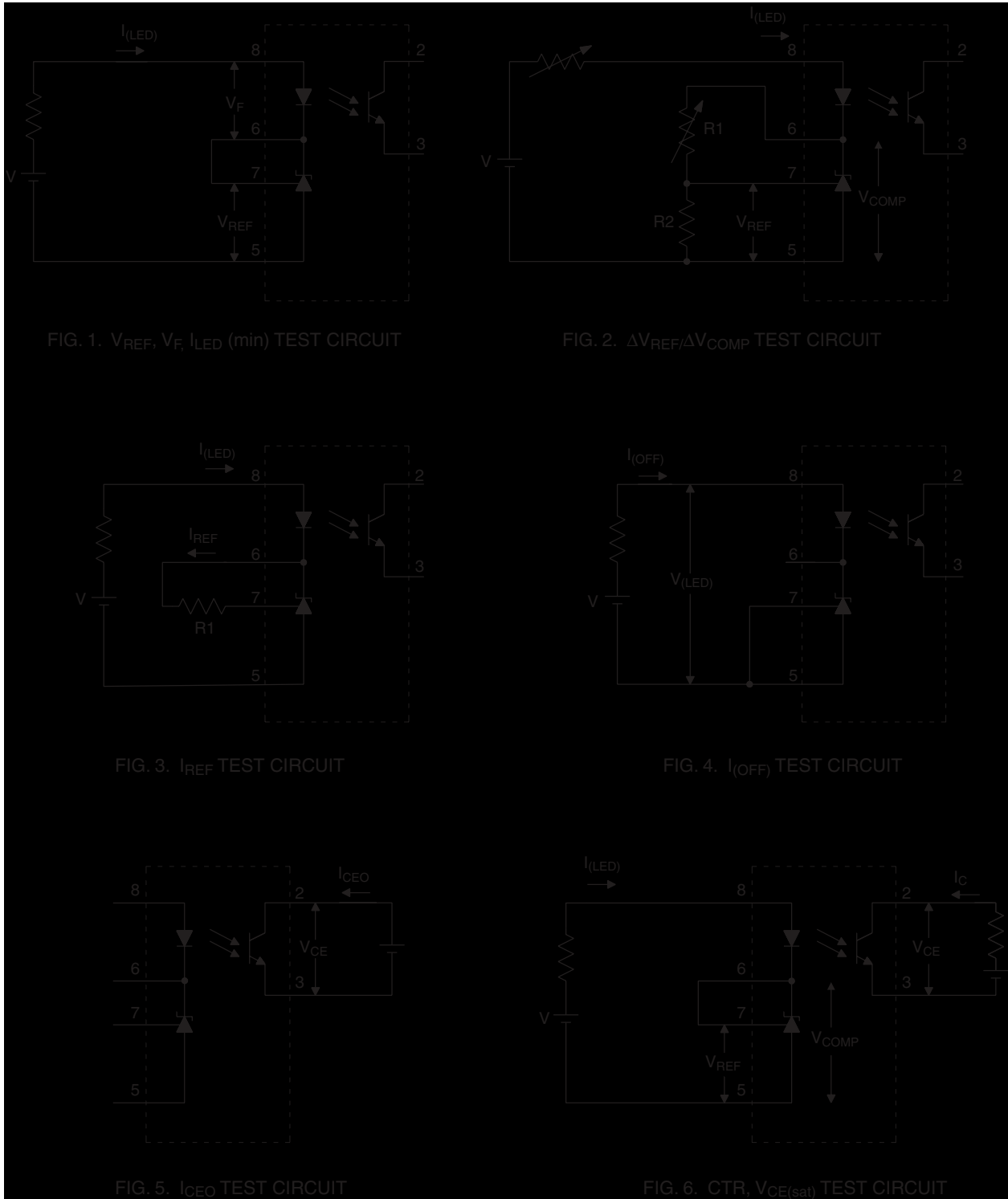

# OPTICALLY ISOLATED ERROR AMPLIFIER

FOD2711

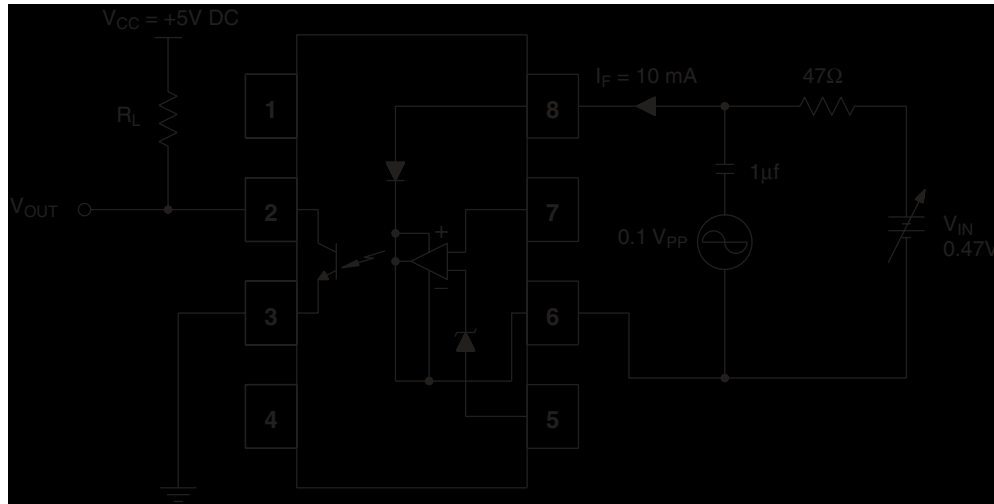

Fig. 7 Frequency Response Test Circuit

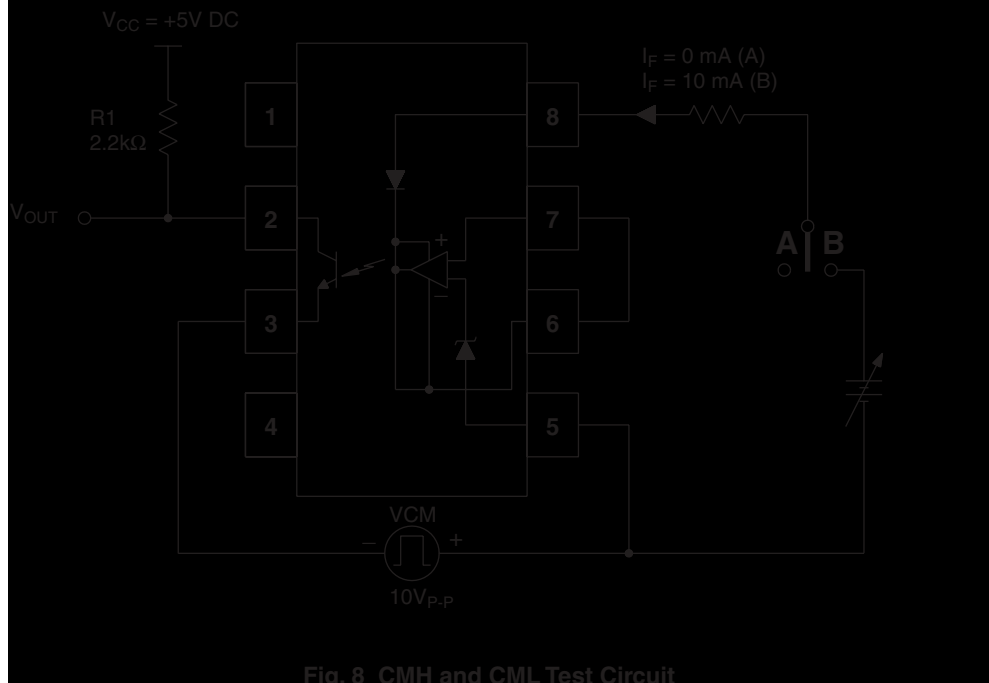
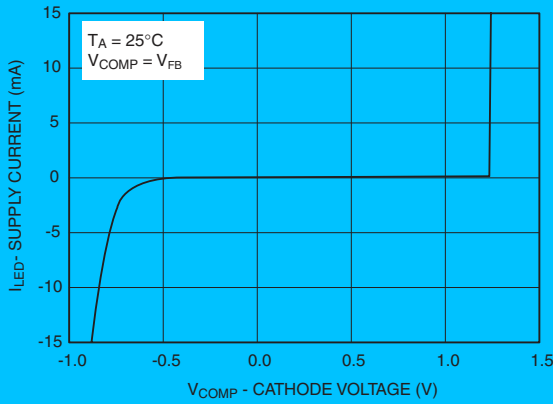

Fig. 8 CMH and CML Test Circuit

### TYPICAL PERFORMANCE CURVES

**Fig. 9a LED Current vs Cathode Voltage**



**Fig. 9b LED Current vs Cathode Voltage**

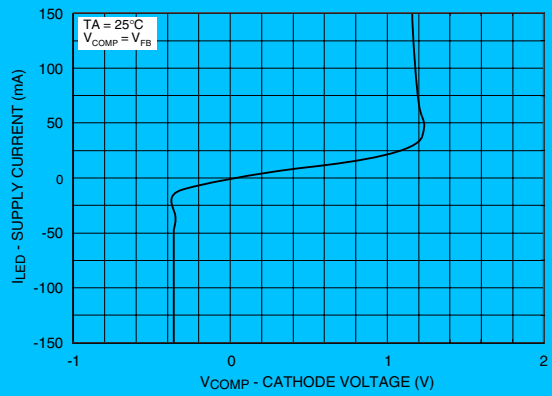

**Fig. 10 Reference Voltage vs Ambient Temperature**

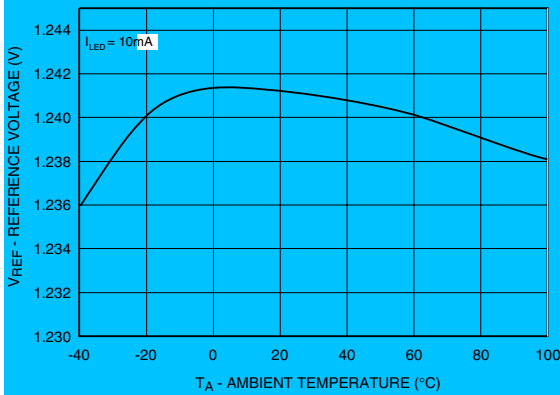

**Fig. 11 Reference Current vs Ambient Temperature**

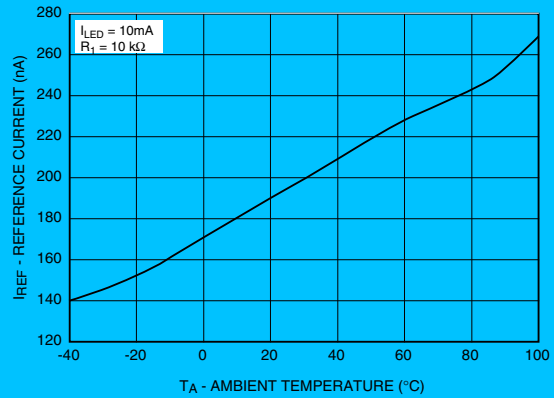

**Fig. 12 Off-State Current vs Ambient Temperature**

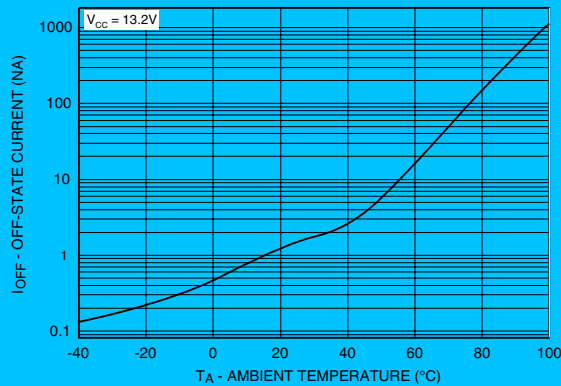





# OPTICALLY ISOLATED ERROR AMPLIFIER

FOD2711

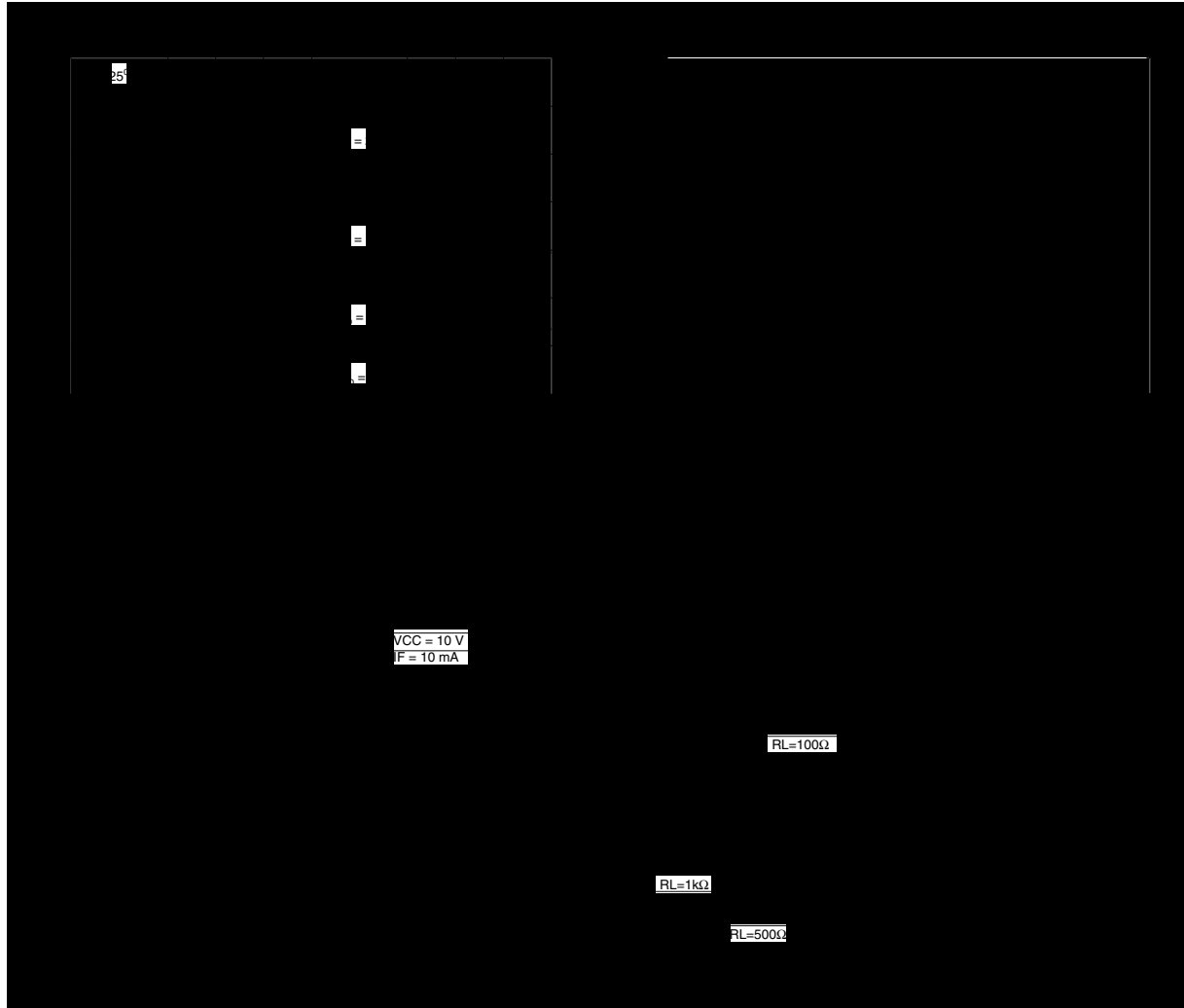

### The FOD2711

The FOD2711 is an optically isolated error amplifier. It incorporates three of the most common elements necessary to make an isolated power supply, a reference voltage, an error amplifier, and an optocoupler. It is functionally equivalent to the popular RC431A shunt voltage regulator plus the CNY17F-3 optocoupler.

### Powering the Secondary Side

The LED pin in the FOD2711 powers the secondary side, and in particular provides the current to run the LED. The actual structure of the FOD2711 dictates the minimum voltage that can be applied to the LED pin: The error amplifier output has a minimum of the reference voltage, and the LED is in series with that. Minimum voltage applied to the LED pin is thus  $1.24V + 1.5V = 2.74V$ . This voltage can be generated either directly from the output of the converter, or else from a slaved secondary winding. The secondary winding will not affect regulation, as the input to the FB pin may still be taken from the output winding.

The LED pin needs to be fed through a current limiting resistor. The value of the resistor sets the amount of current through the LED, and thus must be carefully selected in conjunction with the selection of the primary side resistor.

### Feedback

Output voltage of a converter is determined by selecting a resistor divider from the regulated output to the FB pin. The FOD2711 attempts to regulate its FB pin to the reference voltage, 1.24V. The ratio of the two resistors should thus be:

$$\frac{R_{TOP}}{R_{BOTTOM}} = \frac{V_{OUT}}{V_{REF}} - 1$$

The absolute value of the top resistor is set by the input offset current of  $0.8\mu A$ . To achieve 1% accuracy, the resistance of  $R_{TOP}$  should be:

$$\frac{V_{OUT} - 1.24}{R_{TOP}} > 80\mu A$$

### Compensation

The compensation pin of the FOD2711 provides the opportunity for the designer to design the frequency response of the converter. A compensation network may be placed between the COMP pin and the FB pin. In typical low-bandwidth systems, a  $0.1\mu F$  capacitor may be used. For converters with more stringent requirements, a network should be designed based on measurements of the system's loop. An excellent reference for this process may be found in "Practical Design of Power Supplies" by Ron Lenk, IEEE Press, 1998.

### Secondary Ground

The GND pin should be connected to the secondary ground of the converter.

### No Connect Pins

The NC pins have no internal connection. They should not have any connection to the secondary side, as this may compromise the isolation structure.

### Photo-Transistor

The Photo-transistor is the output of the FOD2711. In a normal configuration the collector will be attached to a pull-up resistor and the emitter grounded. There is no base connection necessary.

The value of the pull-up resistor, and the current limiting resistor feeding the LED, must be carefully selected to account for voltage range accepted by the PWM IC, and for the variation in current transfer ratio (CTR) of the opto-isolator itself.

**Example:** The voltage feeding the LED pins is +12V, the voltage feeding the collector pull-up is +10V, and the PWM IC is the Fairchild KA1H0680, which has a 5V reference. If we select a  $10K\Omega$  resistor for the LED, the maximum current the LED can see is  $(12V - 2.74V) / 10K\Omega = 926\mu A$ . The CTR of the opto-isolator is a minimum of 100%, and so the minimum collector current of the photo-transistor when the diode is full on is also  $926\mu A$ . The collector resistor must thus be such that:

$$\frac{10V - 5V}{R_{COLLECTOR}} < 926\mu A \text{ or } R_{COLLECTOR} > 5.4K\Omega;$$

select  $10K\Omega$  to allow some margin.

# OPTICALLY ISOLATED ERROR AMPLIFIER

FOD2711

## Package Dimensions (Through Hole)

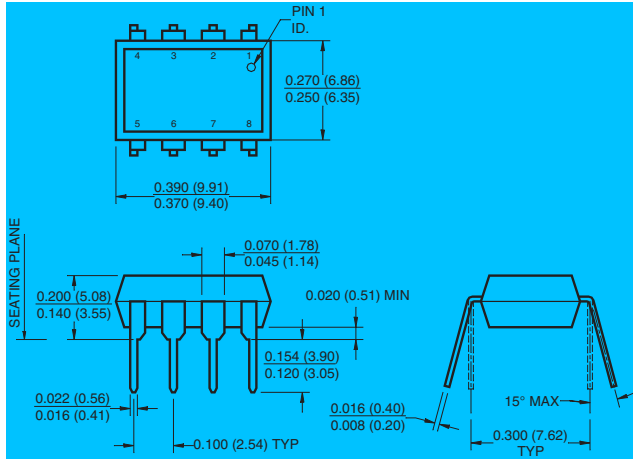

## Package Dimensions (0.4" Lead Spacing)

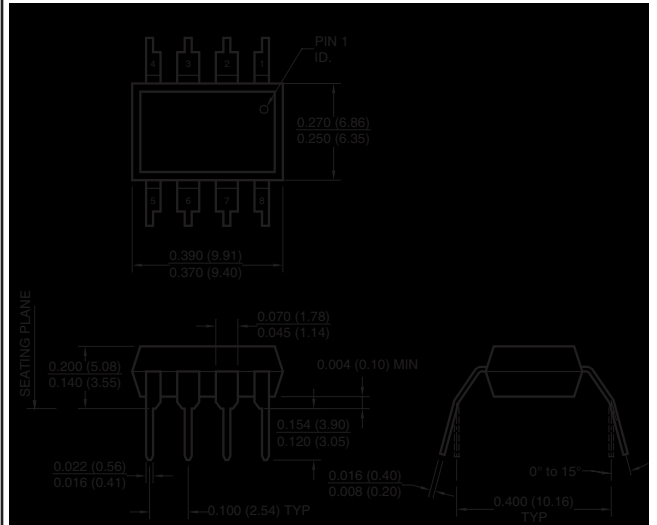

## Package Dimensions (Surface Mount)

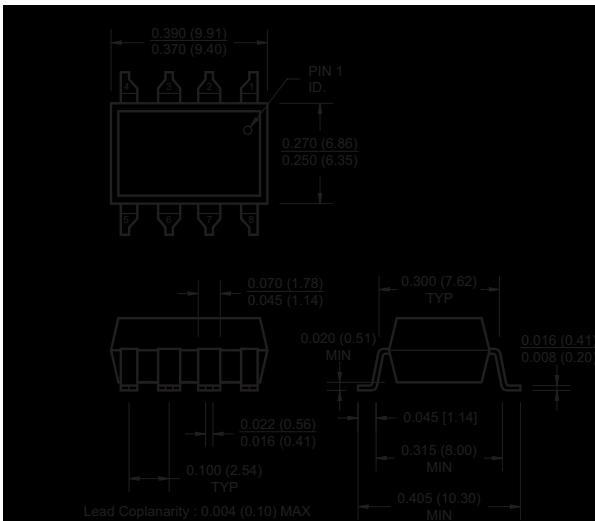

## 8 - Pin Dip

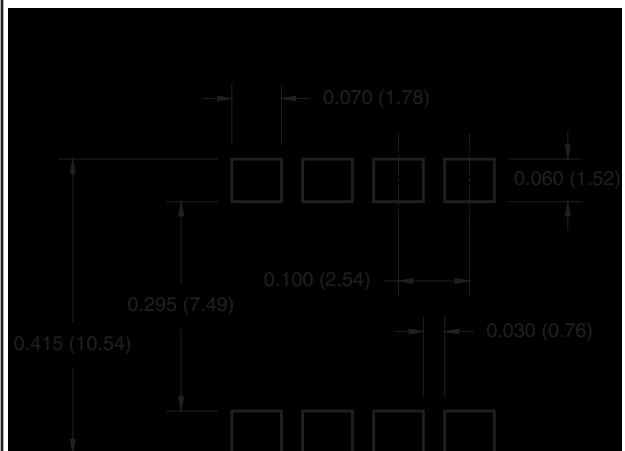

### NOTE

All dimensions are in inches (millimeters)

# OPTICALLY ISOLATED ERROR AMPLIFIER

**FOD2711**

## ORDERING INFORMATION

Example: FOD2711      X      Y

<b>X</b>	<b>Y</b>
<b>Packaging Option</b> T: 0.4" Lead Spacing S: Surface Mount Lead Bend SR2: Surface Mount Tape and Reel (1000 per reel)	V: VDE tested

## Carrier Tape Specifications ("R2" Taping Orientation)



Description	Symbol	Dimension in mm
Tape Width	W	16.0 ± 0.3
Tape Thickness	t	0.30 ± 0.05
Sprocket Hole Pitch	P <sub>0</sub>	4.0 ± 0.1
Sprocket Hole Diameter	D <sub>0</sub>	1.55 ± 0.05
Sprocket Hole Location	E	1.75 ± 0.10
Pocket Location	F	7.5 ± 0.1
	P <sub>2</sub>	4.0 ± 0.1
Pocket Pitch	P	12.0 ± 0.1
Pocket Dimensions	A <sub>0</sub>	10.30 ± 0.20
	B <sub>0</sub>	10.30 ± 0.20
	K <sub>0</sub>	4.90 ± 0.20
Cover Tape Width	W <sub>1</sub>	1.6 ± 0.1
Cover Tape Thickness	d	0.1 max
Max. Component Rotation or Tilt		10°
Min. Bending Radius	R	30

# OPTICALLY ISOLATED ERROR AMPLIFIER

FOD2711

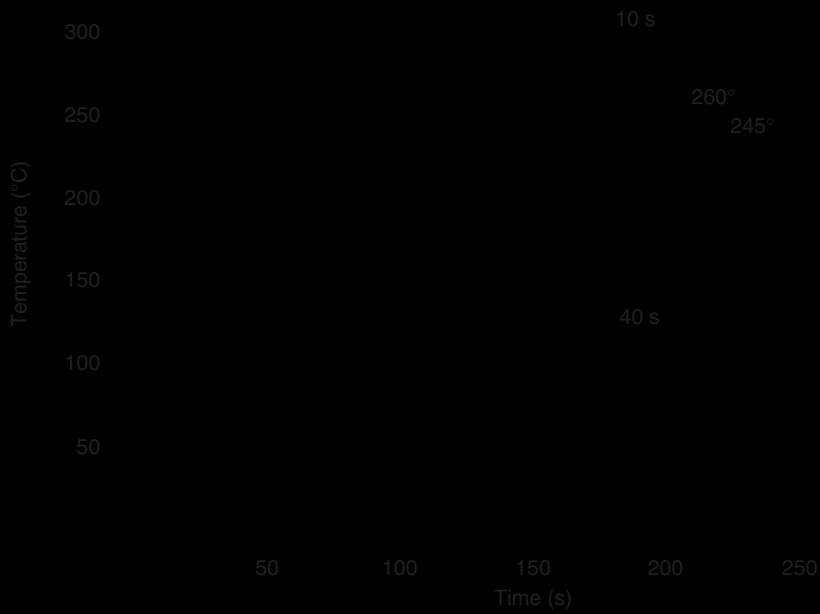



# OPTICALLY ISOLATED ERROR AMPLIFIER

---

## FOD2711

---

### **DISCLAIMER**

FAIRCHILD SEMICONDUCTOR RESERVES THE RIGHT TO MAKE CHANGES WITHOUT FURTHER NOTICE TO ANY PRODUCTS HEREIN TO IMPROVE RELIABILITY, FUNCTION OR DESIGN. FAIRCHILD DOES NOT ASSUME ANY LIABILITY ARISING OUT OF THE APPLICATION OR USE OF ANY PRODUCT OR CIRCUIT DESCRIBED HEREIN; NEITHER DOES IT CONVEY ANY LICENSE UNDER ITS PATENT RIGHTS, NOR THE RIGHTS OF OTHERS.

### **LIFE SUPPORT POLICY**

FAIRCHILD'S PRODUCTS ARE NOT AUTHORIZED FOR USE AS CRITICAL COMPONENTS IN LIFE SUPPORT DEVICES OR SYSTEMS WITHOUT THE EXPRESS WRITTEN APPROVAL OF THE PRESIDENT OF FAIRCHILD SEMICONDUCTOR CORPORATION. As used herein:

1. Life support devices or systems are devices or systems which, (a) are intended for surgical implant into the body, or (b) support or sustain life, and (c) whose failure to perform when properly used in accordance with instructions for use provided in the labeling, can be reasonably expected to result in a significant injury of the user.
2. A critical component in any component of a life support device or system whose failure to perform can be reasonably expected to cause the failure of the life support device or system, or to affect its safety or effectiveness.