

# A 7-Bit Current DAC with PMBus Interface

## FEATURES

- $\pm 0.8\%$   $I_{DAC}$  Positive Output Current Accuracy (Over Temp)
- $\pm 1.5\%$   $I_{DAC}$  Negative Output Current Accuracy (Over Temp)
- PMBus/I<sup>2</sup>C Compliant Serial Interface
- Input Voltage Range: 2.5V to 5.5V
- High Impedance at IDAC Output When Disabled
- Wide IDAC Operation Voltage (0.4V to 2.0V)
- 7-Bit Programmable DAC Output Current for DC/DC  $V_{OUT}$  Control
- Wide Range IDAC Output Current:  $\pm 16\mu A$  to  $\pm 256\mu A$
- Programmable Slew Rate: 500ns ~ 3ms per Bit
- Available in a 10-Lead (3mm × 2mm) DFN Package

## APPLICATIONS

- General Purpose Power Systems
- Telecom Systems
- Industrial Applications

## DESCRIPTION

The LTC7106 is a precision, PMBus controlled, bidirectional current digital-to-analog converter that adjusts the output voltage of any conventional  $V_{FB}$  referenced regulator. The LTC7106 can work with the vast majority of power management controllers or regulators to enable digital control of the output voltage. Internal power-on reset circuitry keeps the DAC output current at zero (high impedance IDAC) until a valid write takes place. Features include a range bit for easy interfacing to almost any impedance resistor divider, and an open-drain GPO output for controlling the Run or Enable pin of the DC/DC regulator. For most applications, the current DAC error is significantly attenuated with proper design. See more detail about  $V_{OUT}$  accuracy in the Applications Information section of this data sheet. The LTC7106 is supported by the ADI LTpowerPlay® development tool with graphical user interface (GUI).

All registered trademarks and trademarks are the property of their respective owners.

## TYPICAL APPLICATION

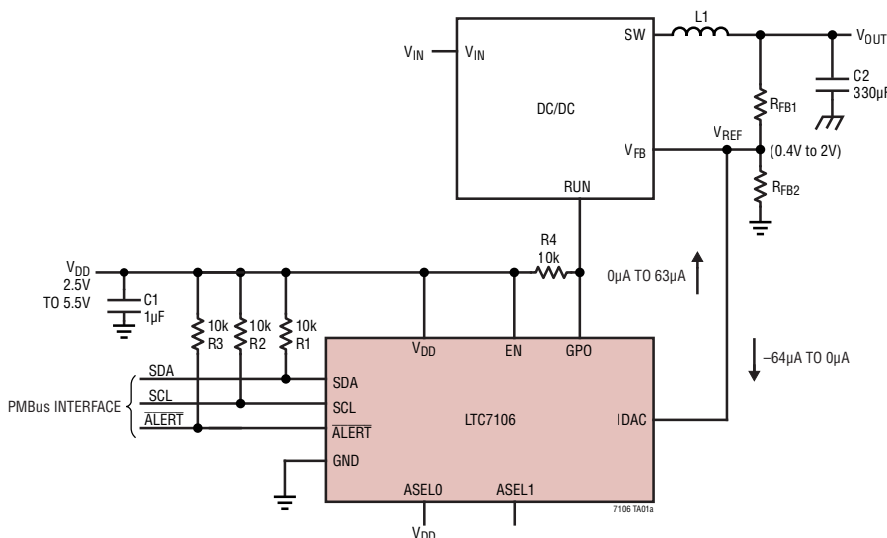

Margin High and Margin Low

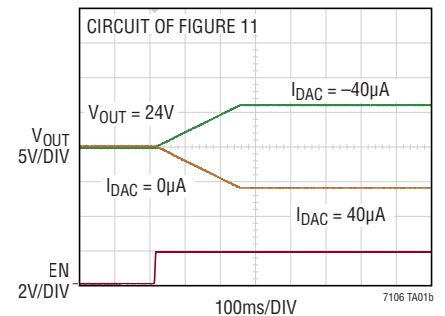

# LTC7106

## ABSOLUTE MAXIMUM RATINGS

(Note 1)

All Pins Except GND ..... -0.3V to 6.0V  
Operating Junction Temperature Range... -40°C to 125°C  
Storage Temperature Range ..... -65°C to 150°C

## PIN CONFIGURATION

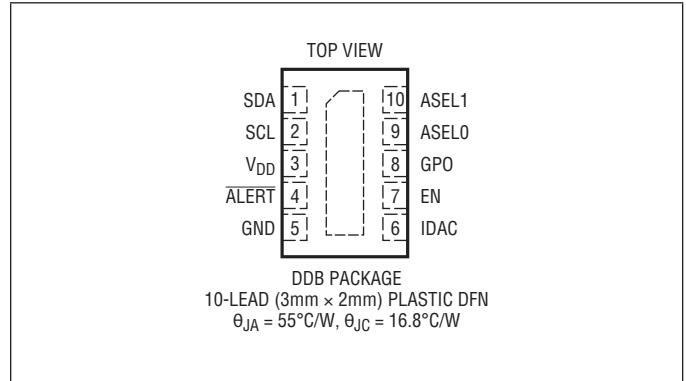

## ORDER INFORMATION <http://www.linear.com/product/LTC7106#orderinfo>

LEAD FREE FINISH	TAPE AND REEL	PART MARKING*	PACKAGE DESCRIPTION	TEMPERATURE RANGE
LTC7106EDDB#PBF	LTC7106EDDB#TRPBF	LHCG	10-Lead (3mm × 2mm) Plastic DFN	-40°C to 125°C
LTC7106IDDB#PBF	LTC7106IDDB#TRPBF	LHCG	10-Lead (3mm × 2mm) Plastic DFN	-40°C to 125°C

Consult ADI Marketing for parts specified with wider operating temperature ranges. \*The temperature grade is identified by a label on the shipping container.

For more information on lead free part marking, go to: <http://www.linear.com/leadfree/>

For more information on tape and reel specifications, go to: <http://www.linear.com/tapeandreeel/>. Some packages are available in 500 unit reels through designated sales channels with #TRMPBF suffix.

## ELECTRICAL CHARACTERISTICS

The ● denotes the specifications which apply over the specified operating junction temperature range, otherwise specifications are at  $T_A = 25^\circ\text{C}$  (Note 2),  $V_{DD} = 3.3\text{V}$ , unless otherwise specified.

SYMBOL	PARAMETER	CONDITIONS	MIN	TYP	MAX	UNITS
$V_{DD}$	Power Supply		2.5		5.5	V
$I_Q$	Supply Quiescent Current	EN High		700	1400	$\mu\text{A}$
$I_{SHUTDOWN}$	Supply Quiescent Current	EN = 0V		800		$\mu\text{A}$
$V_{UVLO\_R}$	Undervoltage Rising Threshold	$V_{DD}$ Rising		2.35		V
$V_{UVLO\_F}$	Undervoltage Falling Threshold	$V_{DD}$ Falling		2.15		V
$V_{EN\_R}$	Enable Rising Threshold	$V_{EN}$ Rising			1.35	V
$V_{EN\_F}$	Enable Falling Threshold	$V_{EN}$ Falling	0.8			V

### IDAC\_OUT

$I_{DAC}$	Accuracy	Full Scale Positive $0.4 \leq V_{IDAC} \leq 2\text{V}$ (Note 3)	Range = Normal	●	62.5	63	63.5	$\mu\text{A}$
			Range = Low	●	15.5	15.75	16.0	$\mu\text{A}$
			Range = High	●	246.7	252.00	255.3	$\mu\text{A}$
		Full Scale Negative $0.4 \leq V_{IDAC} \leq 2\text{V}$ (Note 3)	Range = Normal ( $0^\circ\text{C}$ to $85^\circ\text{C}$ )		-64.64	-64	-63.36	$\mu\text{A}$
			Range = Normal	●	-64.96	-64	-63.04	$\mu\text{A}$
			Range = Low	●	-16.36	-16	-15.64	$\mu\text{A}$
		Range = High	●	-262.50	-256	-249.50	$\mu\text{A}$	
LSB		$0.4 \leq V_{IDAC} \leq 2\text{V}$	Range = Normal			1	$\mu\text{A}$	
			Range = Low			0.25	$\mu\text{A}$	
			Range = High			4	$\mu\text{A}$	
INL		$0.4 \leq V_{IDAC} \leq 2\text{V}$	Range = Normal		-1	1	LSB	
			Range = Low		-1.5	1.5	LSB	
			Range = High		-1.6	1.6	LSB	
DNL		$0.4 \leq V_{IDAC} \leq 2\text{V}$	Range = Normal		-0.3	0.3	LSB	
			Range = Low		-0.5	0.5	LSB	
			Range = High		-0.8	0.8	LSB	
IHZ	High-Z Current	$0.4 \leq V_{IDAC} \leq 2\text{V}$	$V_{EN} = 0$	●		20	nA	

### Digital Input: SDA, SCL

$V_{IH}$					1.4	V
$V_{IL}$				0.8		V
$C_{PIN}$	Input Capacitance				10	pF

### Open-Drain Outputs: ALERTB, GPO, SDA

$V_{OL}$	Output Low Voltage	$I_{SINK} = 3\text{mA}$			0.4	V
----------	--------------------	-------------------------	--	--	-----	---

## PMBus INTERFACE TIMING CHARACTERISTICS

The ● denotes the specifications which apply over the specified operating junction temperature range, otherwise specifications are at  $T_A = 25^\circ\text{C}$  (Note 2),  $V_{DD} = 3.3\text{V}$ , unless otherwise specified.

SYMBOL	PARAMETER	CONDITIONS	MIN	TYP	MAX	UNITS
$f_{SCL}$	Serial Bus Operating Frequency		10		400	kHz
$t_{BUF}$	Bus Free Time Between Stop and Start Condition		1.3			$\mu\text{s}$
$t_{HD\_SDA}$	Hold Time After (Repeated) Start Condition		0.6			$\mu\text{s}$
$t_{SU\_SDA}$	Repeated Start Condition Setup Time		0.6			$\mu\text{s}$
$t_{SU\_STO}$	Stop Condition Setup Time		0.6			$\mu\text{s}$
$t_{HD\_DAT(OUT)}$	Data Hold Time		300		900	ns
$t_{HD\_DAT(IN)}$	Input Data Hold Time		0			ns
$t_{SU\_DAT}$	Data Setup Time		100			ns
$t_{LOW}$	Clock Low Period		1.3		10000	$\mu\text{s}$
$t_{HIGH}$	Clock High Period		0.6			$\mu\text{s}$
$t_{TIMEOUT\_SMB}$	Stuck PMBus Timer			30		ms

**Note 1:** Stresses beyond those listed under Absolute Maximum Ratings may cause permanent damage to the device. Exposure to any Absolute Maximum Rating condition for extended periods may affect device reliability and lifetime.

**Note 2:** The LTC7106 is tested under pulsed load conditions such that  $T_J \approx T_A$ . The LTC7106E is guaranteed to meet performance specifications from  $0^\circ\text{C}$  to  $85^\circ\text{C}$ . Specifications over the  $-40^\circ\text{C}$  to  $125^\circ\text{C}$  operating junction temperature range are assured by design, characterization and correlation with statistical process controls. The LTC7106I is guaranteed over the  $-40^\circ\text{C}$  to  $125^\circ\text{C}$  operating junction temperature range. High junction temperatures degrade operating lifetimes; operating lifetime

is derated for junction temperatures greater than  $125^\circ\text{C}$ . Note that the maximum ambient temperature consistent with these specifications is determined by specific operating conditions in conjunction with board layout, the rated package thermal impedance and other environmental factors.  $T_J$  is calculated from the ambient temperature  $T_A$  and power dissipation  $P_D$  according to the following formula:

$$T_J = T_A + (P_D \cdot 55^\circ\text{C/W})$$

**Note 3:** IDAC is a bidirectional current DAC, controlled by 2's complementary logic. Under the setting of Range = Normal,  $I_{DAC} = 63\mu\text{A}$  for Code = 0111111 provides the maximum source current and  $I_{DAC} = -64\mu\text{A}$  for Code = 1000000 provides the maximum sink current. Max sink current generates the Highest  $V_{OUT}$ , while Max source current generates the lowest  $V_{OUT}$ . See the Operation section for more details.

## TYPICAL PERFORMANCE CHARACTERISTICS

$T_A = 25^\circ\text{C}$ ,  $V_{DD} = 3.3\text{V}$ ,  $V_{IDAC} = 1.0\text{V}$ , Range = Normal unless otherwise noted.

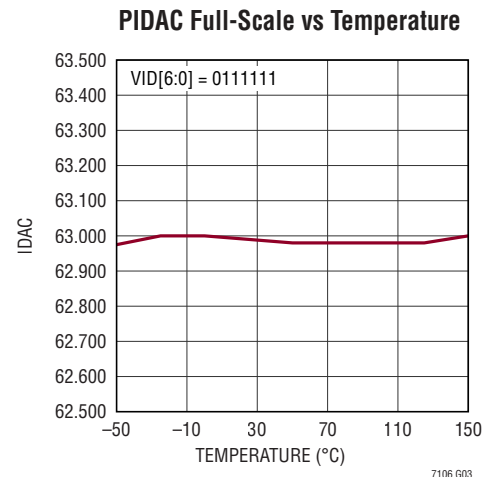
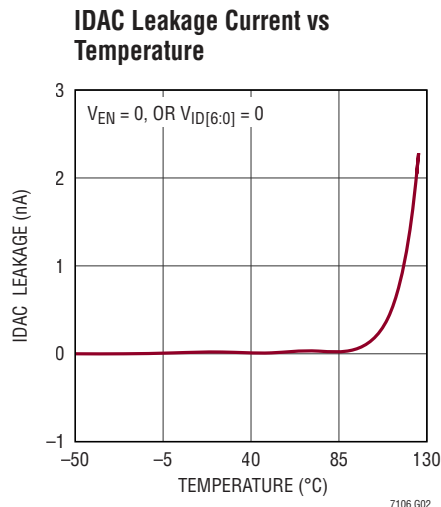
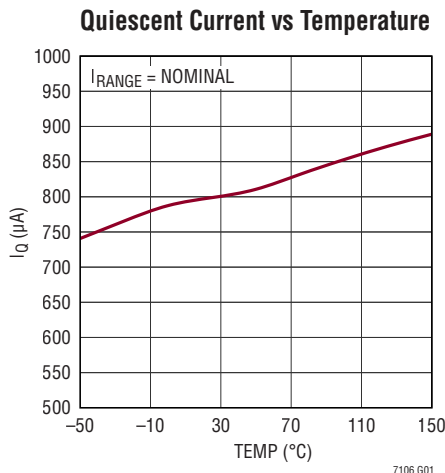

**TYPICAL PERFORMANCE CHARACTERISTICS**

$T_A = 25^\circ\text{C}$ ,  $V_{DD} = 3.3\text{V}$ , Range = Normal unless otherwise noted.

**NIDAC vs Temperature**

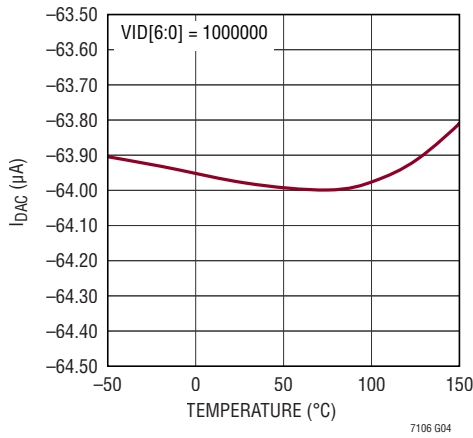

**Differential Nonlinearity**

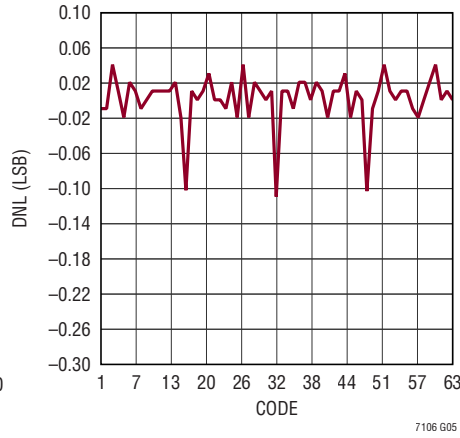

**Integral Nonlinearity**

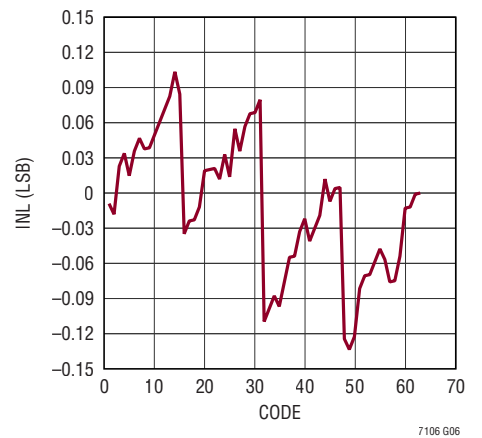

**Buck Start-Up with IDAC**

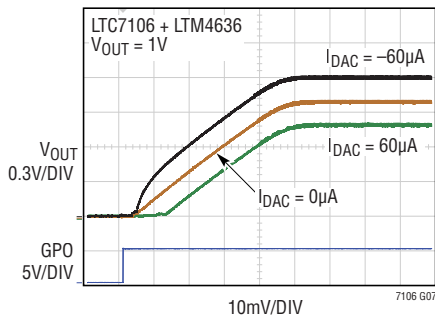

**Margin High and Margin Low**

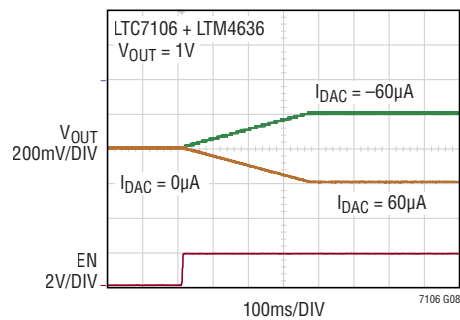

**Boost Start-Up with IDAC**

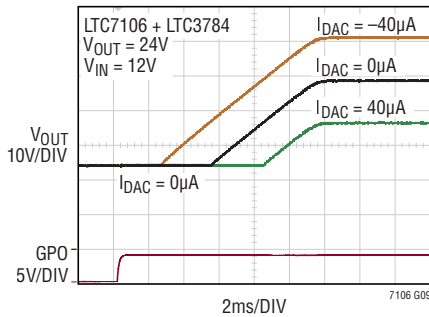

**Margin High and Margin Low**

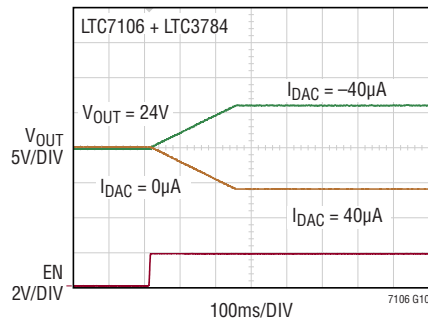

## PIN FUNCTIONS

**V<sub>DD</sub> (Pin 3):** Input Supply. Bypass this pin to GND with a capacitor (0.1 $\mu$ F to 1 $\mu$ F).

**IDAC (Pin 6):** Bidirectional Current DAC Output.

**EN (Pin 7):** Chip Enable Pin. Current DAC output is in Hi-Z state when EN is Grounded. Do not leave EN floating.

**SDA (Pin 1):** Serial Bus Data Input and Open-Drain Output. A pull-up resistor to V<sub>DD</sub> is required in the application.

**SCL (Pin 2):** Serial Bus Clock Input.

**GPO (Pin 8):** Open-Drain Digital Output. A pull-up resistor to V<sub>DD</sub> is required.

**$\overline{\text{ALERT}}$  (Pin 4):** Open-Drain Digital Output. A pull-up resistor to V<sub>DD</sub> is required.

**ASEL1/ASELO (Pins 10, 9):** Serial Bus Address Select Inputs. Each pin has three states (V<sub>DD</sub>, FLOATING and GND); these two pins provide 9 addresses.

**GND (Pin 5):** Ground.

# BLOCK DIAGRAM

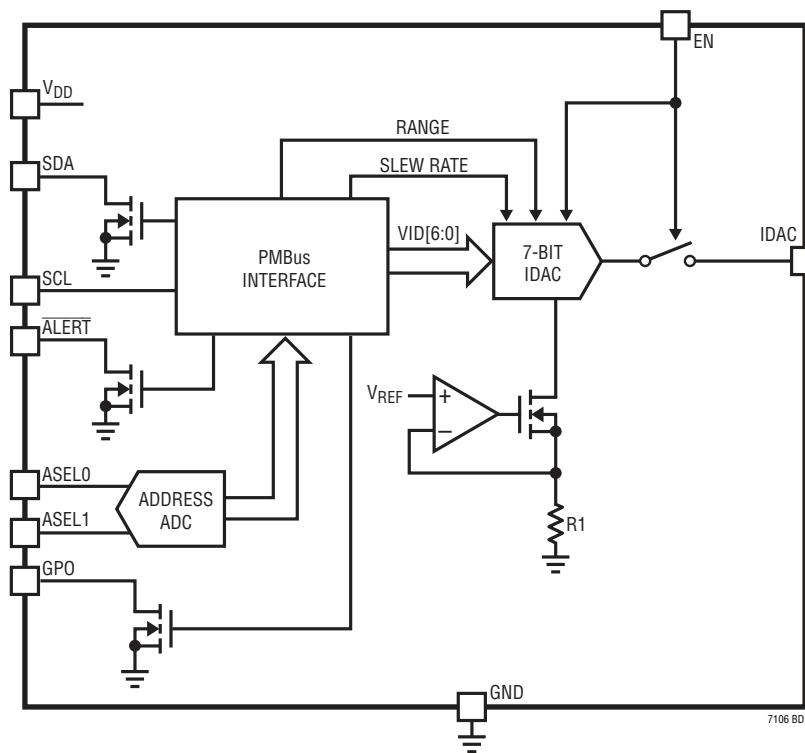

## OPERATION

The LTC7106 is a PMBus controlled 7-bit D/A converter current source. Through its PMBus interface, the LTC7106 receives a 7-bit DAC code and converts this value to a bidirectional analog output current through the pin IDAC. By connecting IDAC to the feedback node of a voltage regulator,  $I_{DAC}$  can change the output voltage of the regulator with the equation:

$$V_{OUT} = V_{REF} \cdot (1 + R_{FB1}/R_{FB2}) - I_{DAC} \cdot R_{FB1}$$

where  $V_{REF}$  is the reference voltage of the voltage regulator.  $R_{FB1}$  and  $R_{FB2}$  are the resistor divider for the voltage regulator.  $I_{DAC}$  is the programmed bidirectional current shown in Table 2.

A typical application diagram is shown on the front page. Therefore, the traditional pure analog designed oriented PWM controller can be controlled by a PMBus interface.

This illustrates the flexibility of the LTC7106 providing a PMBus interface to conventional analog DC/DC converters.

### CHIP ENABLE (EN PIN)

The LTC7106 is activated by the EN pin. It turns on/off the device with threshold of 1.2V. When EN is low (<1.2V), IDAC is in high impedance (Hi-Z).

However, PMBus interface is still active when EN is low which means users can program the device and readback the internal register's value. The device will execute the commands of MFR\_IOUT\_COMMAND,

MFR\_IOUT\_MARGIN\_HIGH, MFR\_IOUT\_MARGIN\_LOW after EN goes high.

### SLEW RATE CONTROL

To prevent abrupt changes in the D/A output current and subsequently the output voltage of the DC/DC regulator, an internal digital programmable slew rate control is included. The slew rate range can be programmed with a 6-bit register from 0.5 $\mu$ s/step to 3.58ms/step with a default value of 3.58ms/step.

### CURRENT RANGE SETTING AND D/A PROGRAMMING

The LTC7106 is a 7-bit bidirectional current DAC with a 1 $\mu$ A LSB as its default setting. The MSB determines the current direction. When MSB is 0,  $I_{DAC}$  is sourcing current (reducing  $V_{OUT}$ ), which is positive current flowing out of the pin, and when MSB is 1,  $I_{DAC}$  is sinking current (increasing  $V_{OUT}$ ), which is negative current flowing into the pin. The LTC7106 also provides range high and range low options through its digital interface to change the LSB value to 4 $\mu$ A expanding the output current range and subsequently widening the programmable output voltage range. Alternately for higher resolution, the low range is provided with a LSB of 0.25 $\mu$ A. Users have additional flexibility of choosing the resistor divider ratio and resistor values to meet the output specification target. However, the design is most accurate using the nominal range which is the recommended setting. Table 1 lists the output current range and Table 2 lists the detailed DAC codes vs  $I_{DAC}$  current.

**Table 1. Output Current Range**

Range	LSB ( $\mu$ A)	$I_{MIN}$ ( $\mu$ A)	$I_{MAX}$ ( $\mu$ A)
Nominal	1	-64	63
Range High	4	-256	252
Range Low	0.25	-16	15.75



## OPERATION

Table 2. IDAC Current and Corresponding DAC Codes

DAC CODE							$I_{DAC}$ ( $\mu$ A)		
[6]	[5]	[4]	[3]	[2]	[1]	[0]	NOMINAL	RANGE HIGH	RANGE LOW
0	0	0	0	0	0	0	0	0	0
0	0	0	0	0	0	1	1	4	0.25
0	0	0	0	0	1	0	2	8	0.5
0	0	0	0	0	1	1	3	12	0.75
0	0	0	0	1	0	0	4	16	1
0	0	0	0	1	0	1	5	20	1.25
0	0	0	0	1	1	0	6	24	1.5
0	0	0	0	1	1	1	7	28	1.75
0	0	0	1	0	0	0	8	32	2
0	0	0	1	0	0	1	9	36	2.25
0	0	0	1	0	1	0	10	40	2.5
0	0	0	1	0	1	1	11	44	2.75
0	0	0	1	1	0	0	12	48	3
0	0	0	1	1	0	1	13	52	3.25
0	0	0	1	1	1	0	14	56	3.5
0	0	0	1	1	1	1	15	60	3.75
0	0	1	0	0	0	0	16	64	4
0	0	1	0	0	0	1	17	68	4.25
0	0	1	0	0	1	0	18	72	4.5
0	0	1	0	0	1	1	19	76	4.75
0	0	1	0	1	0	0	20	80	5
0	0	1	0	1	0	1	21	84	5.25
0	0	1	0	1	1	0	22	88	5.5
0	0	1	0	1	1	1	23	92	5.75
0	0	1	1	0	0	0	24	96	6
0	0	1	1	0	0	1	25	100	6.25
0	0	1	1	0	1	0	26	104	6.5
0	0	1	1	0	1	1	27	108	6.75
0	0	1	1	1	0	0	28	112	7
0	0	1	1	1	0	1	29	116	7.25
0	0	1	1	1	1	0	30	120	7.5
0	0	1	1	1	1	1	31	124	7.75
0	1	0	0	0	0	0	32	128	8
0	1	0	0	0	0	1	33	132	8.25
0	1	0	0	0	1	0	34	136	8.5
0	1	0	0	0	1	1	35	140	8.75
0	1	0	0	1	0	0	36	144	9
0	1	0	0	1	0	1	37	148	9.25

DAC CODE							$I_{DAC}$ ( $\mu$ A)		
[6]	[5]	[4]	[3]	[2]	[1]	[0]	NOMINAL	RANGE HIGH	RANGE LOW
0	1	0	0	1	1	0	38	152	9.5
0	1	0	0	1	1	1	39	156	9.75
0	1	0	1	0	0	0	40	160	10
0	1	0	1	0	0	1	41	164	10.25
0	1	0	1	0	1	0	42	168	10.5
0	1	0	1	0	1	1	43	172	10.75
0	1	0	1	1	0	0	44	176	11
0	1	0	1	1	0	1	45	180	11.25
0	1	0	1	1	1	0	46	184	11.5
0	1	0	1	1	1	1	47	188	11.75
0	1	1	0	0	0	0	48	192	12
0	1	1	0	0	0	1	49	196	12.25
0	1	1	0	0	1	0	50	200	12.5
0	1	1	0	0	1	1	51	204	12.75
0	1	1	0	1	0	0	52	208	13
0	1	1	0	1	0	1	53	212	13.25
0	1	1	0	1	1	0	54	216	13.5
0	1	1	0	1	1	1	55	220	13.75
0	1	1	1	0	0	0	56	224	14
0	1	1	1	0	0	1	57	228	14.25
0	1	1	1	0	1	0	58	232	14.5
0	1	1	1	0	1	1	59	236	14.75
0	1	1	1	1	0	0	60	240	15
0	1	1	1	1	0	1	61	244	15.25
0	1	1	1	1	1	0	62	248	15.5
0	1	1	1	1	1	1	63	252	15.75
1	0	0	0	0	0	0	-64	-256	-16
1	0	0	0	0	0	1	-63	-252	-15.75
1	0	0	0	0	1	0	-62	-248	-15.5
1	0	0	0	0	1	1	-61	-244	-15.25
1	0	0	0	1	0	0	-60	-240	-15
1	0	0	0	1	0	1	-59	-236	-14.75
1	0	0	0	1	1	0	-58	-232	-14.5
1	0	0	0	1	1	1	-57	-228	-14.25
1	0	0	1	0	0	0	-56	-224	-14
1	0	0	1	0	0	1	-55	-220	-13.75
1	0	0	1	0	1	0	-54	-216	-13.5
1	0	0	1	0	1	1	-53	-212	-13.25

## OPERATION

Table 2. IDAC Current and Corresponding DAC Codes (Continued)

DAC CODE							I <sub>DAC</sub> (μA)		
[6]	[5]	[4]	[3]	[2]	[1]	[0]	NOMINAL	RANGE HIGH	RANGE LOW
1	0	0	1	1	0	0	-52	-208	-13
1	0	0	1	1	0	1	-51	-204	-12.75
1	0	0	1	1	1	0	-50	-200	-12.5
1	0	0	1	1	1	1	-49	-196	-12.25
1	0	1	0	0	0	0	-48	-192	-12
1	0	1	0	0	0	1	-47	-188	-11.75
1	0	1	0	0	1	0	-46	-184	-11.5
1	0	1	0	0	1	1	-45	-180	-11.25
1	0	1	0	1	0	0	-44	-176	-11
1	0	1	0	1	0	1	-43	-172	-10.75
1	0	1	0	1	1	0	-42	-168	-10.5
1	0	1	0	1	1	1	-41	-164	-10.25
1	0	1	1	0	0	0	-40	-160	-10
1	0	1	1	0	0	1	-39	-156	-9.75
1	0	1	1	0	1	0	-38	-152	-9.5
1	0	1	1	0	1	1	-37	-148	-9.25
1	0	1	1	1	0	0	-36	-144	-9
1	0	1	1	1	0	1	-35	-140	-8.75
1	0	1	1	1	1	0	-34	-136	-8.5
1	0	1	1	1	1	1	-33	-132	-8.25
1	1	0	0	0	0	0	-32	-128	-8
1	1	0	0	0	0	1	-31	-124	-7.75
1	1	0	0	0	1	0	-30	-120	-7.5
1	1	0	0	0	1	1	-29	-116	-7.25
1	1	0	0	1	0	0	-28	-112	-7
1	1	0	0	1	0	1	-27	-108	-6.75

DAC CODE							I <sub>DAC</sub> (μA)		
[6]	[5]	[4]	[3]	[2]	[1]	[0]	NOMINAL	RANGE HIGH	RANGE LOW
1	1	0	0	1	1	0	-26	-104	-6.5
1	1	0	0	1	1	1	-25	-100	-6.25
1	1	0	1	0	0	0	-24	-96	-6
1	1	0	1	0	0	1	-23	-92	-5.75
1	1	0	1	0	1	0	-22	-88	-5.5
1	1	0	1	0	1	1	-21	-84	-5.25
1	1	0	1	1	0	0	-20	-80	-5
1	1	0	1	1	0	1	-19	-76	-4.75
1	1	0	1	1	1	0	-18	-72	-4.5
1	1	0	1	1	1	1	-17	-68	-4.25
1	1	1	0	0	0	0	-16	-64	-4
1	1	1	0	0	0	1	-15	-60	-3.75
1	1	1	0	0	1	0	-14	-56	-3.5
1	1	1	0	0	1	1	-13	-52	-3.25
1	1	1	0	1	0	0	-12	-48	-3
1	1	1	0	1	0	1	-11	-44	-2.75
1	1	1	0	1	1	0	-10	-40	-2.5
1	1	1	0	1	1	1	-9	-36	-2.25
1	1	1	1	0	0	0	-8	-32	-2
1	1	1	1	0	0	1	-7	-28	-1.75
1	1	1	1	0	1	0	-6	-24	-1.5
1	1	1	1	0	1	1	-5	-20	-1.25
1	1	1	1	1	0	0	-4	-16	-1
1	1	1	1	1	0	1	-3	-12	-0.75
1	1	1	1	1	1	0	-2	-8	-0.5
1	1	1	1	1	1	1	-1	-4	-0.25

## OPERATION

### GPO

GPO is a general purpose open-drain output pin, which can be set by PMBus command. It is designed to turn on/off the DC/DC regulator by connecting GPO to the RUN pin of the regulator. Once GPO is set high, it stays high even if the EN pin goes low as long as the device is not power cycled.

### ADDRESS

The PMBus address is selected by ASELO and ASEL1 pins. Each pin has three states: high, low and floating. The possible PMBus addresses are shown in Table 3.

**Table 3. Address Selection**

ASEL1	ASELO	PMBus ADDRESS
GND	GND	2A
GND	V <sub>DD</sub>	2C
GND	FLOAT	2E
V <sub>DD</sub>	GND	4A
V <sub>DD</sub>	V <sub>DD</sub>	4C
V <sub>DD</sub>	FLOAT	4E
FLOAT	GND	6A
FLOAT	V <sub>DD</sub>	6C
FLOAT	FLOAT	6E

### PMBus SERIAL INTERFACE

The LTC7106 serial interface is a PMBus-compliant slave device and can operate at any frequency between 10kHz and 400kHz. In addition the LTC7106 always responds to the global broadcast address of 0x5A or 0x5B (7-bit). The serial interface supports the following protocols defined in the PMBus specifications: 1) send command, 2) write byte, 3) group, 4) read byte and 5) read word. The PMBus write operations are not acted upon until a complete valid message is received by the LTC7106 including the STOP bit.

### Communication Failure

Attempts to access unsupported commands or writing invalid data to supported commands will result in a CML fault. The CML bit is set in the STATUS\_BYTE command and the  $\overline{\text{ALERT}}$  pin is pulled low.

### Device Addressing

The LTC7106 offers four different types of addressing over the PMBus interface, specifically: 1) global, 2) device, 3) rail addressing and 4) alert response address (ARA).

Global addressing provides a means of the PMBus master to address all LTC7106 devices on the bus. The LTC7106 global addresses are fixed 0x5A or 0x5B (7 bit) or 0xB4 or 0xB6 (8 bit) and cannot be disabled.

Device addressing provides the standard means of the PMBus master communicating with a single instance of a LTC7106. The value of the device address is set by the ASELO/ASEL1 configuration pins. Rail addressing provides a means of the PMBus master addressing a set of channels connected to the same output rail, simultaneously. This is similar to global addressing, however, the PMBus address can be dynamically assigned by using the MFR\_RAIL\_ADDRESS command. It is recommended that rail addressing should be limited to command write operations.

All four means of PMBus addressing require the user to employ disciplined planning to avoid addressing conflicts.

### Fault Status

The STATUS\_BYTE and  $\overline{\text{ALERT}}$  pin provide fault status information of the LTC7106 to the host.

### Bus Timeout Failure

The LTC7106 implements a timeout feature to avoid hanging the serial interface. The data packet timer begins at the first START event before the device address write byte. Data packet information must be completed within 25ms or the LTC7106 will tri-state the bus and ignore the given data packet. Data packet information includes the device address byte write, command byte, repeat start event (if a read operation), device address byte read (if a read operation), and all data bytes.

The user is encouraged to use as high a clock rate as possible to maintain efficient data packet transfer between all devices sharing the serial bus interface. The LTC7106 supports the full PMBus frequency range from 10kHz to 400kHz.

## OPERATION

### Similarity Between PMBus, SMBus and I<sup>2</sup>C 2-Wire Interface

The PMBus 2-wire interface is an incremental extension of the SMBus. SMBus is built upon I<sup>2</sup>C with some minor differences in timing, DC parameters and protocol. The PMBus/SMBus protocols are more robust than simple I<sup>2</sup>C byte commands because PMBus/SMBus provide timeouts to prevent bus hangs and valid operation commands. In general, a master device that can be configured for I<sup>2</sup>C communication can be used for PMBus communication with little or no change to hardware or firmware. Repeat start (restart) is not supported by all I<sup>2</sup>C controllers but is required for SMBus/PMBus reads. If a general purpose I<sup>2</sup>C controller is used, check that repeat start is supported.

For a description of the minor extensions and exceptions PMBus makes to SMBus, refer to PMBus Specification Part 1, Revision 1.1: Paragraph 5: Transport.

For a description of the differences between SMBus and I<sup>2</sup>C, refer to System Management Bus (SMBus) Specification Version 2.0: Appendix B—Differences Between SMBus and I<sup>2</sup>C.

### PMBus SERIAL INTERFACE

The LTC7106 communicates with a host (master) using the standard PMBus serial bus interface. The Timing Diagram, Figure 1, shows the timing relationship of the signals on the bus. The two-bus lines, SDA and SCL, must be high when the bus is not in use. External pull-up resistors or current sources are required on these lines.

The LTC7106 is a slave device. The master can communicate with the LTC7106 using the following formats:

- Master Transmitter, Slave Receiver
- Master Receiver, Slave Transmitter

The following PMBus protocols are supported:

- Write Byte, Send Byte
- Read Byte, Read Word
- Alert Response Address

Figure 3 through Figure 6 illustrate the aforementioned PMBus protocols. All transactions support GCP (group command protocol).

Figure 2 is a key to the protocol diagrams in this section.

A value shown below a field in the following figures is a mandatory value for that field.

The data formats implemented by PMBus are:

- Master transmitter transmits to slave receiver. The transfer direction in this case is not changed.
- Master reads slave immediately after the first byte. At the moment of the first acknowledgment (provided by the slave receiver) the master transmitter becomes a master receiver and the slave receiver becomes a slave transmitter.
- Combined format. During a change of direction within a transfer, the master repeats both a start condition and the slave address but with the R/ $\bar{W}$  bit reversed. In this case, the master receiver terminates the transfer by generating a NACK on the last byte of the transfer and a STOP condition.

Examples of these formats are shown in Figure 4 and Figure 5.

# OPERATION

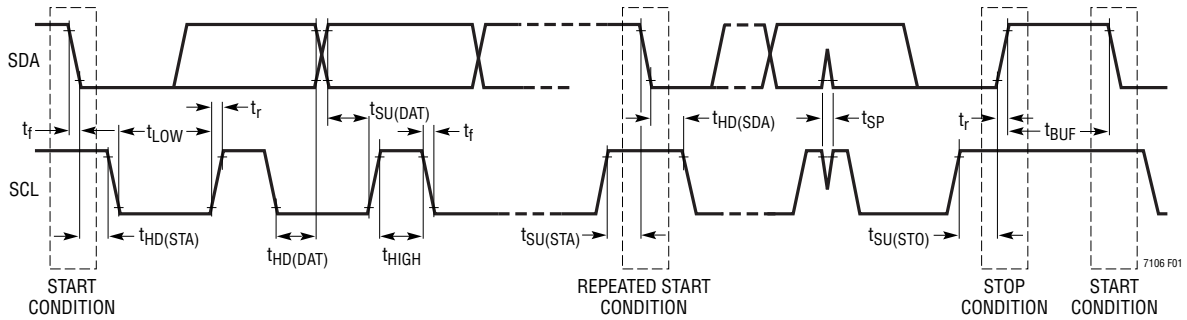

Figure 1. Timing Diagram

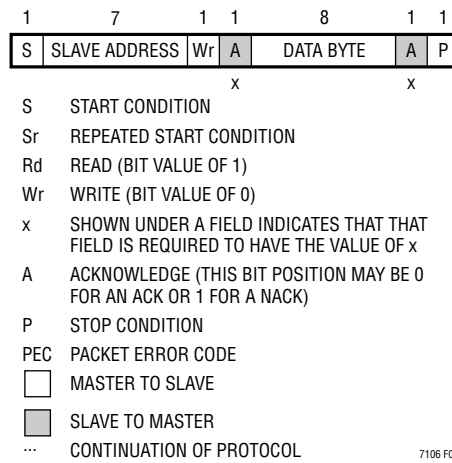

Figure 2. PMBus Packet Protocol Diagram Element Key

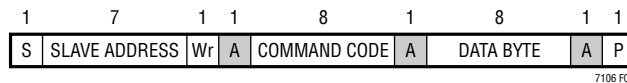

Figure 3. Write Byte Protocol

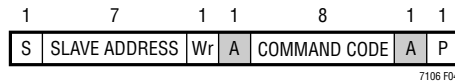

Figure 4. Send Byte Protocol

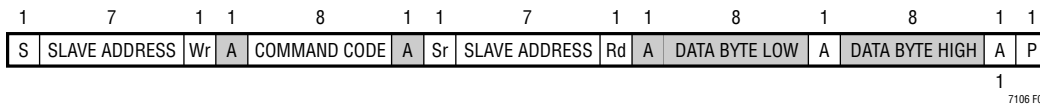

Figure 5. Read Word Protocol

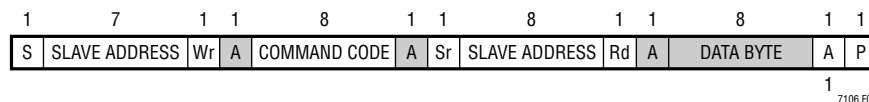

Figure 6. Read Byte Protocol

## REGISTER COMMAND DETAILS

Table 4. LTC7106 Supported PMBus Commands

PMBus CODE (8 BITS)	R/W TYPE	COMMAND NAME	DESCRIPTION
0x01	R/W	OPERATION	Default is On: [7:0] = 0x80
0x78	R/W	STATUS_BYTE	Read Fault Status: CML, Write 1 to Reset
0x98	Read	PMBUS_REVISION	Read PMBus Revision = 0x22 for Rev 1.2
0xE2	R/W	MFR_CHIP_CTRL	[7:4] – Reserved: [7:0] = 0x00 Default [0] = GPO EN, [1] = Reserved, [2] = Write Protect, [3] = Timeout Status
0xE4	R/W	MFR_DAC_CTRL	[7:6] = Current Step Control, [5:0] = DAC Slew Rate Control
0xE5	R/W	MFR_IOUT_MARGIN_HIGH	Same Format as MFR_IOUT_COMMAND
0xE6	R/W	MFR_IOUT_MAX	Clamped Value that DAC Cannot Exceed. Default 7-Bit Value of 0x00 = Source Current Only
0xE7	Read	MFR_SPECIAL_ID	MFR Special ID for LTC7106 = 0x8080
0xE8	R/W	MFR_IOUT_COMMAND	I <sub>OUT</sub> Margining Command (see Table 5) [5:0] Step Value, Source: [6] = 0, Sink: [6] = 1
0xED	R/W	MFR_IOUT_MARGIN_LOW	Same Format as MFR_IOUT_COMMAND
0xFA	R/W	MFR_RAIL_ADDRESS	Set Common PMBus Address [6:0], [7] = 0 Enable, [7] = 1 Disable
0xFD	Write	MFR_RESET	Reset PMBus Interface to Power-On State Write Data is Ignored; 0, 1, 2 Bytes

### MFR\_IOUT\_COMMAND

The DAC output current command is formatted as a 7-bit 2's complement value. When the operation register is set to 0x80, DAC takes the value stored in this register. Setting bit[6] to 0 sources the current from the IC and bit[6] to 1 sinks the current into the IC. Default value for this register is 0x00. The valid range of values are from 0x40 to 0x3F.

Do not attempt to write values outside of this range or undesired behavior may result. Writes to this register are inhibited when the WPB, bit [2] in MFR\_CHIP\_CTRL, is set high.

### MFR\_IOUT\_MARGIN\_HIGH

DAC margining register with the same format and rules as MFR\_IOUT\_COMMAND. The DAC value will take the value stored in this register when the operation register is set to margin high, 0xA8.

### MFR\_IOUT\_MARGIN\_LOW

DAC margining register with the same format and rules as MFR\_IOUT\_COMMAND. The DAC value will take the value stored in this register when the operation register is set to margin low, 0x98.

### MFR\_IOUT\_MAX

Clamping value that DAC cannot exceed. The format is a 7-bit 2's complement value, the same as the margin registers. Therefore, the DAC value cannot be a smaller 2's complement value than what is stored in this register.

The 7-bit default value is 0x00 = cannot sink current. I<sub>OUT</sub> cannot be set to a higher value unless this value is changed to a negative number, bit [7] = 1.

Setting this register to 0x40 allows the LTC7106 to sink the maximum current with no clamping.

## REGISTER COMMAND DETAILS

### MFR\_CHIP\_CTRL

This register is for general chip control and status. Please refer to Table 7 for each bit description.

#### Bits Description

- [7:4] Reserved
- [3] Timeout Status:  
0 = No PMBus Timeout Occurred  
1 = A Timeout Occurred  
Writing a 1 to this bit will clear this bit
- [2] Write Protect for Margin Registers  
0 = Write Allowed  
1 = Writes Inhibited
- [1] Reserved
- [0] GPO, General Purpose Output  
0 = GPO Pulls Open Drain to GND  
1 = Hi-Z on GPO

### MFR\_DAC\_CTRL

8-bit register to control the  $I_{DAC}$  LSB current value and the timer count for the slew rate control. Default value = 0x40.

#### Bits Description

- [7:6] Selector Range for  $I_{DAC}$  Step Current:  
b'00 = 0.25 $\mu$ A/Step, Range Low  
b'01 = 1.0 $\mu$ A/Step, Nominal  
b'10 = 4.0 $\mu$ A/Step, Range High  
b'11 = Reserved
- [5:0] Selector for Time in  $\mu$ s/Step  
Default Value 0x00 = Max = 3584 $\mu$ s/Step  
See Table 6 for Allowable Values

Only a power cycle, POR, will reset this register to prevent unwanted immediate current changes in  $I_{DAC}$ . MFR\_RESET will not reset this register.

In addition,  $I_{DAC}$  must be at 0x00 to change the current range selector to prevent unwanted large swings in  $I_{DAC}$  current. The time step selector, bits [5:0], can be changed at any time.

**Table 5. Programmable Delay Per Current Step**

Slew Rate Timer Clock ( $\mu$ s/Step)					
[5:0]		[5:0]		[5:0]	
000000	= 3584	010000	= 16	100000	= 256
000001	= 0.5	010001	= 20	100001	= 320
000010	= 1.0	010010	= 24	100010	= 384
000011	= 1.5	010011	= 28	100011	= 448
000100	= 2.0	010100	= 32	100100	= 512
000101	= 2.5	010101	= 40	100101	= 640
000110	= 3.0	010110	= 48	100110	= 768
000111	= 3.5	010111	= 56	100111	= 896
001000	= 4.0	011000	= 64	101000	= 1280*
001001	= 5.0	011001	= 80	101001	= 1280
001010	= 6.0	011010	= 96	101010	= 1536
001011	= 7.0	011011	= 112	101011	= 1792
001100	= 8.0	011100	= 128	101100	= 2560*
001101	= 10	011101	= 160	101101	= 2560
001110	= 12	011110	= 192	101110	= 3584*
001111	= 14	011111	= 224	101111	= 3584

\* Duplicate Encoding

## PMBus COMMAND DETAILS

### MFR\_RESET

This command provides a means by which the user can perform a reset of the LTC7106. All latched faults ( $\overline{\text{ALERT}}$  and status register) and register contents will be reset to a power-on condition by this command.  $V_{\text{OUT}}$  will remain in regulation but may change due to the reset of the margin registers.

This write-only command accepts zero, one, or two data bytes but ignores them.

### MFR\_RAIL\_ADDRESS

The MFR\_RAIL\_ADDRESS command allows all devices to share a common address, such as all devices attached to a single power supply rail. The desired 7-bit address value is written to the 7 bits of the data byte.

The MSB (bit B7) must be set low to enable communication using the MFR\_RAIL\_ADDRESS address. Setting this bit disables this address. The default for this register is 0x80.

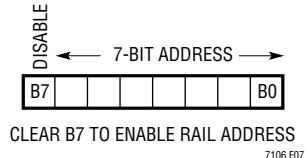

Figure 7. MFR\_RAIL\_ADDRESS Data Byte

The user should only perform command writes to this address. If a read is performed from this address and the rail devices do not respond with EXACTLY the same value, the LTC7106 will detect bus contention and abort its read command with no CML or ALERTB set.

This command accepts one or two data bytes but the second is ignored.

### OPERATION

The OPERATION command is used to turn the unit on/off and for margining the output voltage.

The ON bit is automatically reset to ON after a master shutdown (EN), power cycle, or MFR\_RESET command.

The MARGIN\_LOW/HIGH bits command the  $I_{\text{OUT}}$  reference to the offset value stored in either the MFR\_IOUT\_MARGIN\_HIGH or MFR\_IOUT\_MARGIN\_LOW.

This command has one data byte. It will accept one or two but ignores the second byte.

Table 6. Supported OPERATION Command Register Values

ACTION	VALUE
Turn Off Immediately	0x00
Turn On	0x80
Margin Low	0x98
Margin High	0xA8

### PMBus\_REVISION

The PMBUS\_REVISION command indicates the revision of the PMBus to which the device is compliant. The LTC7106 is PMBus Version 1.2 compliant in both Part I and Part II.

This read-only command has one data byte and will return 0x22.

### MFR\_SPECIAL\_ID

The 16-bit word representing a unique identification for LTpowerPlay.

This read-only command has 2 data bytes and is set to 0x8080.



## PMBus COMMAND DETAILS

### STATUS\_BYTE

The STATUS\_BYTE command returns one byte of information with a summary of the unit's fault condition.

See Table 7 for a list of the status bits that are supported and the conditions in which each bit is set. Certain bits when set in the STATUS\_BYTE also cause the  $\overline{\text{ALERT}}$  pin to be asserted.

Writing a "1" to a particular bit in the status byte will attempt to reset that fault in the status byte and the  $\overline{\text{ALERT}}$  pin. If

the fault is still present the status byte bit and  $\overline{\text{ALERT}}$  will remain asserted. If the  $\overline{\text{ALERT}}$  has previously been cleared by an ARA message, the  $\overline{\text{ALERT}}$  will be re-asserted. If the fault is no longer present, the  $\overline{\text{ALERT}}$  pin will be de-asserted and the fault bit in the status byte will be cleared.

All bits in the status byte are also cleared by toggling the RUN\_MSTR pin or the ON bit in OPERATION. The bit will immediately be set again if the fault remains.

**Table 7. Status Byte Bit Descriptions and Conditions**

BIT	DESCRIPTION	CONDITION	SET ALERT?	CLEARABLE BY WRITING '1' TO BIT?
0 (LSB)	None of the Above	MFR_VOUT_MAX Register Exceeded	No	Yes
1	Communication Failure	(See Note 1)	Yes	Yes
2	Temperature Fault	Not Implemented		
3	V <sub>IN</sub> Undervoltage Fault	Not Implemented		
4	Output Overcurrent Fault	Not Implemented		
5	Output Overvoltage Fault	Not Implemented		
6	OFF	Not Implemented		
7	Busy	Not Implemented		

**Note 1:** Communication failure is one of following faults: host sends too few bits, host reads too few bits, host writes too few bytes, improper R/W bit set, unsupported command code, attempt to write to a read-only command. See PMBus Specification v1.2, Part II, Sections 10.8 and 10.9 for more information.

## APPLICATIONS INFORMATION

### I<sub>DAC</sub> ACCURACY

The LTC7106 provides three ranges of I<sub>DAC</sub> output current. However, only nominal range (LSB = ±1μA) is optimized with the highest accuracy. It is recommended that users design the resistor divider using the nominal range of the IDAC setting.

### TWO'S COMPLEMENTARY CODE

VID [6:0] of the LTC7106 is in the format of two's complementary. From Table 2, it is easy to program the register once the desired output current is known. For example, if output current is 20μA, then set VID [6:0] = 0010100. If the output current is -20μA, then set VID [6:0] = 1101100 for the nominal I<sub>DAC</sub> setting.

### V<sub>OUT</sub> ACCURACY

When I<sub>DAC</sub> = 0, define:

$$V_{OUT0} = V_{REF} \left[ 1 + \frac{R_{FB1}}{R_{FB2}} \right] \quad (1)$$

Referring to Figure 8, the output voltage is set according to:

$$V_{OUT} = V_{REF} \left[ 1 + \frac{R_{FB1}}{R_{FB2}} \right] - I_{DAC} \cdot R_{FB1} \quad (2)$$

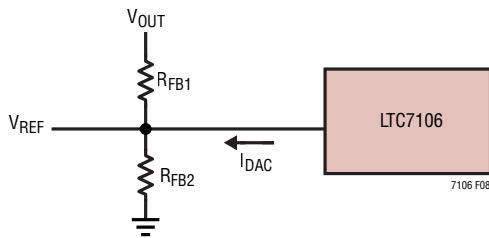

Figure 8. Setting the Output Voltage Using the LTC7106

Define  $\Delta V_{OUT}$  as the  $V_{OUT}$  error caused by the  $I_{DAC}$  error  $\Delta I_{DAC}$ , then we can derive the following equation from equation (1) and (2):

$$\frac{\Delta V_{OUT}}{V_{OUT}} = \left( \frac{\Delta I_{DAC} / I_{DAC}}{\text{Ratio} - 1} \right) \quad (3)$$

Where:

$$\text{Ratio} = \frac{V_{OUT0}}{I_{DAC} \cdot R_{FB1}} \quad (4)$$

It is clear that when  $\text{Ratio} < 0$  or  $\text{Ratio} \geq 2$ , the  $V_{OUT}$  error can be attenuated from the  $I_{DAC}$  error:

$$\left| \frac{\Delta V_{OUT}}{V_{OUT}} \right| \leq \left| \frac{\Delta I_{DAC}}{I_{DAC}} \right| \quad (5)$$

In the case of margin high,  $I_{DAC} < 0$  so  $\text{Ratio} < 0$ . Therefore, the  $V_{OUT}$  error is always smaller than the  $I_{DAC}$  error by a factor of:

$$\frac{V_{OUT0}}{I_{DAC} \cdot R_{FB1}} - 1 \quad (6)$$

In the case of margin low,  $I_{DAC} > 0$ . So the  $V_{OUT}$  error will only be attenuated when:

$$\begin{aligned} \text{Ratio} = \frac{V_{OUT0}}{I_{DAC} \cdot R_{FB1}} > 2 \\ \text{or } I_{DAC} \cdot R_{FB1} < \frac{V_{OUT0}}{2} \end{aligned} \quad (7)$$

In other words, as long as  $V_{OUT}$  is margining low within 50% of the  $V_{OUT}$  default value,  $V_{OUT0}$ , the  $V_{OUT}$  error won't be larger than the  $I_{DAC}$  error.

### DESIGN EXAMPLES

The LTC7106 can work with almost all the power management controllers or regulators. Figure 9, Figure 10 and Figure 11 show three design examples using the LTC7106 to control the output voltage with a monolithic buck regulator, an  $\mu$ Module® and a boost controller.







## PACKAGE DESCRIPTION

Please refer to <http://www.linear.com/product/LTC7106#packaging> for the most recent package drawings.

### DDB Package 10-Lead Plastic DFN (3mm × 2mm) (Reference LTC DWG # 05-08-1722 Rev 0)

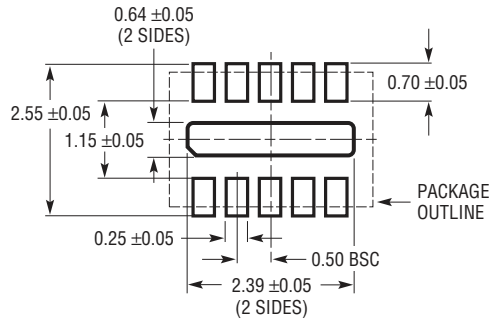

RECOMMENDED SOLDER PAD PITCH AND DIMENSIONS

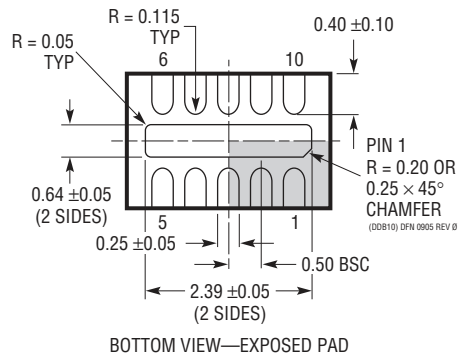
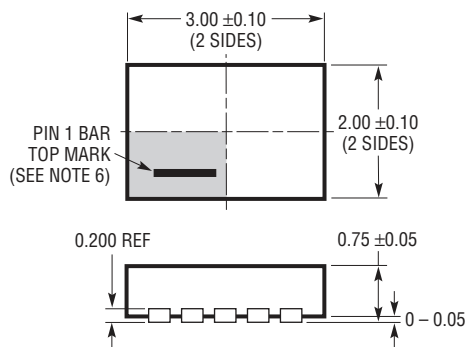

**NOTE:**

1. DRAWING CONFORMS TO VERSION (WECD-1) IN JEDEC PACKAGE OUTLINE M0-229
2. DRAWING NOT TO SCALE
3. ALL DIMENSIONS ARE IN MILLIMETERS
4. DIMENSIONS OF EXPOSED PAD ON BOTTOM OF PACKAGE DO NOT INCLUDE MOLD FLASH. MOLD FLASH, IF PRESENT, SHALL NOT EXCEED 0.15mm ON ANY SIDE
5. EXPOSED PAD SHALL BE SOLDER PLATED
6. SHADED AREA IS ONLY A REFERENCE FOR PIN 1 LOCATION ON THE TOP AND BOTTOM OF PACKAGE

## REVISION HISTORY

REV	DATE	DESCRIPTION	PAGE NUMBER
A	04/18	Clarified MFG_RAIL_ADDRESS and MFG_SPECIAL_ID paragraphs Changed from "Status Word" to "Status Byte"	15 16

## TYPICAL APPLICATION

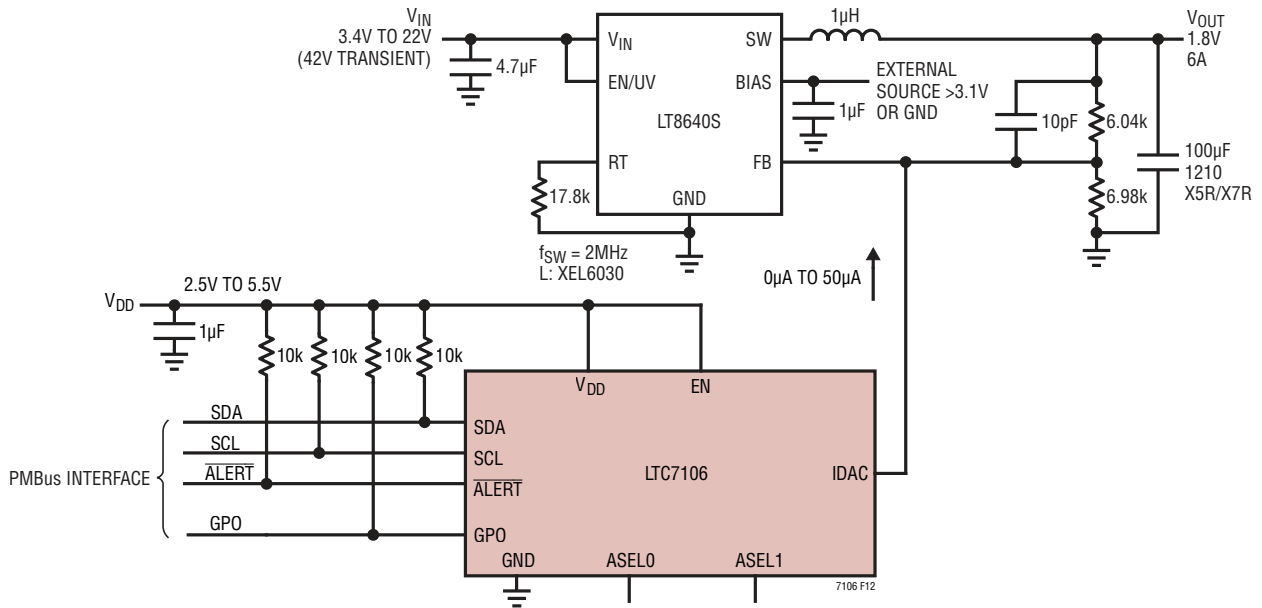

Figure 12. Margining a LT8640S from 1.8V to 1.5V at 6A

## RELATED PARTS

PART NUMBER	DESCRIPTION	COMMENTS
<a href="#">LTC3605/LTC3605A</a>	20V, 5A Synchronous Step-Down Regulator	4V < V <sub>IN</sub> < 20V, 0.6V < V <sub>OUT</sub> < 20V, 96% Maximum Efficiency, 4mm × 4mm QFN-24 Package
<a href="#">LTC3626</a>	20V, 2.5A Synchronous Step-Down Regulator with Current and Temperature Monitoring	95% Efficiency, V <sub>IN</sub> : 3.6V to 20V, V <sub>OUT(MIN)</sub> = 0.6V, I <sub>Q</sub> = 300μA, ISD < 15μA, 3mm × 4mm QFN-20
<a href="#">LTC3636</a>	20V, Dual 6A Synchronous Step-Down Regulator	95% Efficiency, V <sub>IN</sub> : 3.1V to 17V, V <sub>OUT(MIN)</sub> = 0.6V, I <sub>Q</sub> < 8μA (Both Channels Enabled), ISD < 1μA, 3mm × 5mm QFN-24 Package
<a href="#">LTC3779</a>	150V V <sub>IN</sub> and V <sub>OUT</sub> Synchronous 4-Switch Buck-Boost DC/DC Controller	4.5V ≤ V <sub>IN</sub> ≤ 150V, Input or Output Average Current Loop, PLL, TSSOP-38 Package
<a href="#">LTC3784</a>	Low I <sub>Q</sub> , Multiphase, Dual Channel Single Output Synchronous Step-Up DC/DC Controller	4.5V (Down to 2.5V After Start-Up) ≤ V <sub>IN</sub> ≤ 60V, V <sub>OUT</sub> Up to 60V, PLL Fixed Frequency 50kHz to 900kHz, I <sub>Q</sub> = 28μA
<a href="#">LTC3807</a>	38V, Low I <sub>Q</sub> , Synchronous Step-Down Controller with 24V Output Voltage Capability	PLL Fixed Frequency 50kHz to 900kHz, 4V ≤ V <sub>IN</sub> ≤ 38V, 0.8V ≤ V <sub>OUT</sub> ≤ 24V, I <sub>Q</sub> = 50μA
<a href="#">LTC3871</a>	100V Bidirectional PolyPhase <sup>®</sup> Buck or Boost Controller	Dynamic Regulation of V <sub>IN</sub> , V <sub>OUT</sub> and Current, PLL, Current Monitor, 48-Lead LQPF Package
<a href="#">LTM<sup>®</sup>4636</a>	40A DC/DC μModule Step-Down Regulator	Complete 40A Switch Mode Power Supply, 4.75V ≤ V <sub>IN</sub> ≤ 15V, 0.6V ≤ V <sub>OUT</sub> ≤ 3.3V, 16mm × 16mm × 7.12mm BGA
<a href="#">LTC7150S</a>	20V, 20A Synchronous Step-Down Regulator	93% Efficiency, V <sub>IN</sub> : 3.1V to 20V, V <sub>OUT(MIN)</sub> = 0.6V, Output Remote Sense, 42-Lead 6mm × 5mm × 1.3mm BGA Package
<a href="#">LT<sup>®</sup>8640S</a>	42V, 6A Synchronous Step-Down Silent Switcher <sup>®</sup> 2	I <sub>Q</sub> = 2.5μA, V <sub>IN(MIN)</sub> = 3.4V, V <sub>OUT(MAX)</sub> = 42V, V <sub>OUT(MIN)</sub> = 0