

2170747-6 ✓ ACTIVE

zQSFP+/QSFP28

TE Internal #: 2170747-6

QSFP, QSFP+ & zQSPF+, Cage Assembly, 1 x 4, Internal/External EMI Springs, Included Lightpipe, Standard, Data Rate (Max) 28 Gb/s, zQSFP+/QSFP28

[View on TE.com >](#)



Connectors > Pluggable IO Connectors & Cages > QSFP, QSFP+ & zQSPF+

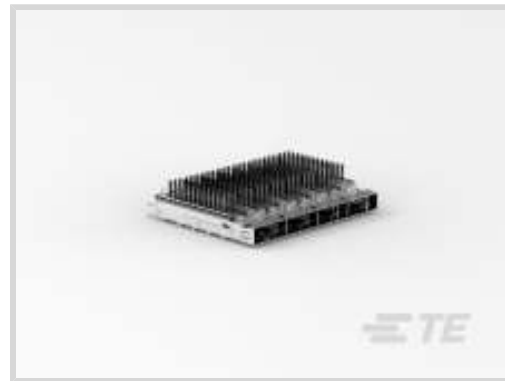

Pluggable I/O Product Type: **Cage Assembly**

Port Matrix Configuration: **1 x 4**

EMI Containment Feature Type: **Internal/External EMI Springs**

Thermal Accessory Type Included: **Heat Sink**

Included Lightpipe: **Yes**

Features

Product Type Features

Form Factor	QSFP28/56
Cage Type	Ganged
Pluggable I/O Product Type	Cage Assembly
Thermal Accessory Type Included	Heat Sink
Connector System	Cable-to-Board
Sealable	No
Connector & Contact Terminates To	Printed Circuit Board

Configuration Features

Port Matrix Configuration	1 x 4
Number of Ports	4
Lightpipe Configuration	Single Round
Number of Rear EONs per Port Column	0

Electrical Characteristics

Data Rate (Max)	28 Gb/s
-----------------	---------

Body Features

Heat Sink Finish	Anodized Black
Heat Sink Style	Pin



Heat Sink Height Class	Networking
------------------------	------------

Heat Sink Height	13.5 mm[.531 in]
------------------	------------------

Contact Features

PCB Contact Termination Area Plating Material	Tin
-----------------------------------------------	-----

Termination Features

Termination Post & Tail Length	2.05 mm[.081 in]
--------------------------------	------------------

Termination Method to Printed Circuit Board	Through Hole - Press-Fit
---------------------------------------------	--------------------------

Mechanical Attachment

Connector Mounting Type	Board Mount
-------------------------	-------------

Housing Features

Cage Material	Nickel Silver
---------------	---------------

Dimensions

PCB Thickness (Recommended)	1.57 mm[.062 in]
-----------------------------	------------------

Usage Conditions

Operating Temperature Range	-40 – 85 °C[-40 – 185 °F]
-----------------------------	---------------------------

Operation/Application

Heat Sink Compatible	Yes
----------------------	-----

For Use With Pluggable I/O Products	QSFP28 Cable Assembly, QSFP28 MSA Compatible Transceiver
-------------------------------------	----------------------------------------------------------

Pluggable I/O Applications	SFP+ Stacked Belly-to-Belly
----------------------------	-----------------------------

Circuit Application	Signal
---------------------	--------

Industry Standards

UL Flammability Rating	UL 94V-0
------------------------	----------

Packaging Features

Packaging Method	Box & Tray
------------------	------------

Other

EMI Containment Feature Type	Internal/External EMI Springs
------------------------------	-------------------------------

Included Lightpipe	Yes
--------------------	-----

Enhancements	Standard
--------------	----------

Product Compliance

For compliance documentation, visit the product page on [TE.com](#)>







EU RoHS Directive 2011/65/EU	Compliant
EU ELV Directive 2000/53/EC	Compliant
China RoHS 2 Directive MIIT Order No 32, 2016	No Restricted Materials Above Threshold
EU REACH Regulation (EC) No. 1907/2006	Current ECHA Candidate List: JUNE 2023 (235) Candidate List Declared Against: JUNE 2022 (224) Does not contain REACH SVHC
Halogen Content	Not Low Halogen - contains Br or Cl > 900 ppm.
Solder Process Capability	Not applicable for solder process capability

Product Compliance Disclaimer

This information is provided based on reasonable inquiry of our suppliers and represents our current actual knowledge based on the information they provided. This information is subject to change. The part numbers that TE has identified as EU RoHS compliant have a maximum concentration of 0.1% by weight in homogenous materials for lead, hexavalent chromium, mercury, PBB, PBDE, DBP, BBP, DEHP, DIBP, and 0.01% for cadmium, or qualify for an exemption to these limits as defined in the Annexes of Directive 2011/65/EU (RoHS2). Finished electrical and electronic equipment products will be CE marked as required by Directive 2011/65/EU. Components may not be CE marked. Additionally, the part numbers that TE has identified as EU ELV compliant have a maximum concentration of 0.1% by weight in homogenous materials for lead, hexavalent chromium, and mercury, and 0.01% for cadmium, or qualify for an exemption to these limits as defined in the Annexes of Directive 2000/53/EC (ELV). Regarding the REACH Regulation, the information TE provides on SVHC in articles for this part number is based on the latest European Chemicals Agency (ECHA) 'Guidance on requirements for substances in articles' posted at this URL: <https://echa.europa.eu/guidance-documents/guidance-on-reach>

Compatible Parts

 <p>TE Part # CAT-C11-Z806726 QSFP28 to QSFP28 Cable Assembly: 30 AWG</p>	 <p>TE Part # CAT-C11-N49 QSFP28-Two QSFP28 Cable Assembly: 30 AWG</p>	 <p>TE Part # CAT-C11-Z8 QSFP28 to QSFP28 Cable Assembly: 26 AWG</p>	 <p>TE Part # CAT-C11-N490333 QSFP28-Four SFP+ Cable Assembly: 30 AWG</p>
 <p>TE Part # CAT-C11-N490325 QSFP28-Four SFP+ Cable Assembly: 26 AWG</p>	 <p>TE Part # CAT-Q17-N490325 QSFP56 to QSFP56 Cable Assembly: 30 AWG</p>	 <p>TE Part # CAT-Q17-N49033 QSFP56-Two QSFP56 Cable Assembly: 30 AWG</p>	 <p>TE Part # CAT-C11-Q17 QSFP56 to QSFP56 Cable Assembly: 26 AWG</p>



TE Part # CAT-Q17-N49011
QSFP56-Four SFP56 Cable Assembly:
30 AWG



TE Part # CAT-Q17-N490333
QSFP56-Four SFP56 Cable Assembly:
26 AWG



TE Part # 1551920-2
zQSFP+ connector assembly



TE Part # 1888810-2
EMI/Dust Cover, XFP And QSFP



TE Part # 2185225-1
ASSY, SEATING TOOL, CUSTOM



TE Part # 4-2215048-6
ASSY, SEATING TL, QSFP28, 1X4

Also in the Series | **zQSFP+/QSFP28**



Pluggable I/O Cable Assemblies(81)



QSFP, QSFP+ & zQSFP+(432)

Customers Also Bought



TE Part #1-1879075-1
THS25 R68 5%



TE Part #1676264-2
RN 0805 249R 0.1% 10PPM 1KRL



TE Part #5-160429-2
187 FASTON REC 16-14 AWG TPBR



TE Part #1676300-2
RN 0805 30K1 0.1% 10PPM 1KRL

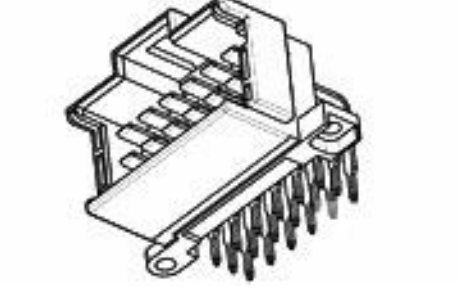

TE Part #966140-3
MESSERLEISTE 12P



TE Part #185904-2
Signal Header



TE Part #2343428-1
HD+ CE, RA, CRPS



Documents

Product Drawings

[CAGE ASSY, 1X4, QSFP28, SPRING, HS, LP](#)

English

CAD Files

[3D PDF](#)

3D

Customer View Model

[ENG_CVM_CVM_2170747-6_A.2d_dxf.zip](#)

English

Customer View Model

[ENG_CVM_CVM_2170747-6_A.3d_igs.zip](#)

English

Customer View Model

[ENG_CVM_CVM_2170747-6_A.3d_stp.zip](#)

English

By downloading the CAD file I accept and agree to the [Terms and Conditions](#) of use.

Datasheets & Catalog Pages

[QSFP28/56 and zQSFP+ Interconnects](#)

English

Product Specifications

[Application Specification](#)

English

Product Environmental Compliance

[MD_2170747-6_1129201741_dmtec](#)

English

[MD_2170747-6_1129201741_dmtec](#)

English