

PCB terminal block - MKDS 2,5/ 6-5,08 - 1730434

Please be informed that the data shown in this PDF Document is generated from our Online Catalog. Please find the complete data in the user's documentation. Our General Terms of Use for Downloads are valid (<http://download.phoenixcontact.com>)



PC terminal block, Nominal current: 24 A, Nom. voltage: 400 V, Pitch: 5.08 mm, Number of positions: 6, Connection method: Screw connection, Mounting: Soldering, Conductor/PCB connection direction: 0°, Color: green

The illustration shows a combination as a 12-position version



Key commercial data

Packing unit	1
Minimum order quantity	1
GTIN	 4 017918 116217
Custom tariff number	85369010
Country of origin	GERMANY

Technical data

Dimensions / positions

Length	11.62 mm
Pitch	5.08 mm
Dimension a	25.4 mm
Number of positions	6
Pin dimensions	1,1 x 0,8 mm
Hole diameter	1.4 mm
Screw thread	M3
Tightening torque, min	0.5 Nm
Tightening torque max	0.6 Nm

Technical data

Range of articles	MKDS 2,5
Insulating material group	I
Rated surge voltage (III/3)	4 kV
Rated surge voltage (III/2)	4 kV
Rated surge voltage (II/2)	4 kV
Rated voltage (III/3)	250 V

PCB terminal block - MKDS 2,5/ 6-5,08 - 1730434

Technical data

Technical data

Rated voltage (III/2)	400 V
Rated voltage (II/2)	630 V
Connection in acc. with standard	EN-VDE
Nominal current I _N	24 A
Nominal cross section	2.5 mm ²
Maximum load current	24 A
Insulating material	PA
Inflammability class according to UL 94	V0
Internal cylindrical gage	A3
Stripping length	8 mm
Nominal voltage, UL/CUL Use Group B	300 V
Nominal current, UL/CUL Use Group B	10 A
Nominal voltage, UL/CUL Use Group D	300 V
Nominal current, UL/CUL Use Group D	10 A

Connection data

Conductor cross section solid min.	0.14 mm ²
Conductor cross section solid max.	2.5 mm ²
Conductor cross section stranded min.	0.14 mm ²
Conductor cross section stranded max.	2.5 mm ²
Conductor cross section stranded, with ferrule without plastic sleeve min.	0.25 mm ²
Conductor cross section stranded, with ferrule without plastic sleeve max.	2.5 mm ²
Conductor cross section stranded, with ferrule with plastic sleeve min.	0.25 mm ²
Conductor cross section stranded, with ferrule with plastic sleeve max.	1.5 mm ²
Conductor cross section AWG/kcmil min.	26
Conductor cross section AWG/kcmil max	14
2 conductors with same cross section, solid min.	0.14 mm ²
2 conductors with same cross section, solid max.	0.75 mm ²
2 conductors with same cross section, stranded min.	0.14 mm ²
2 conductors with same cross section, stranded max.	0.75 mm ²
2 conductors with same cross section, stranded, ferrules without plastic sleeve, min.	0.25 mm ²
2 conductors with same cross section, stranded, ferrules without plastic sleeve, max.	0.75 mm ²
2 conductors with same cross section, stranded, TWIN ferrules with plastic sleeve, min.	0.5 mm ²
2 conductors with same cross section, stranded, TWIN ferrules with plastic sleeve, max.	1.5 mm ²
Minimum AWG according to UL/CUL	30
Maximum AWG according to UL/CUL	12

PCB terminal block - MKDS 2,5/ 6-5,08 - 1730434

Classifications

eclass

eCl@ss 4.0	27141109
eCl@ss 4.1	27141109
eCl@ss 5.0	27141190
eCl@ss 5.1	27141190
eCl@ss 6.0	27261101
eCl@ss 7.0	27440401

etim

ETIM 3.0	EC001121
ETIM 4.0	EC002643
ETIM 5.0	EC002643

unspsc

UNSPSC 6.01	30211801
UNSPSC 7.0901	39121432
UNSPSC 11	39121432
UNSPSC 12.01	39121432
UNSPSC 13.2	39121432

Approvals

Approvals

Approvals

CSA / UL Recognized / SEV / cUL Recognized / CCA / GOST / cULus Recognized

Ex Approvals

Approvals submitted

Approval details

CSA 	
mm ² /AWG/kcmil	28-12
Nominal current I _N	10 A
Nominal voltage U _N	300 V

PCB terminal block - MKDS 2,5/ 6-5,08 - 1730434

Approvals

UL Recognized 

	B	D
mm ² /AWG/kcmil	30-12	30-12
Nominal current I _N	10 A	10 A
Nominal voltage U _N	300 V	300 V

SEV

mm ² /AWG/kcmil	2.5
Nominal voltage U _N	250 V

cUL Recognized 

	B	D
mm ² /AWG/kcmil	30-12	30-12
Nominal current I _N	10 A	10 A
Nominal voltage U _N	300 V	300 V

CCA

mm ² /AWG/kcmil	2.5
Nominal voltage U _N	250 V

GOST 

cULus Recognized 

Accessories

Accessories

Marking

PCB terminal block - MKDS 2,5/ 6-5,08 - 1730434

Accessories

Marker cards - SK 5,08/3,8:FORTL.ZAHLEN - 0804293



Marker cards, Card, white, labeled, Horizontal: Consecutive numbers 1 - 10, 11 - 20, etc. up to 91 - (99)100, Mounting type: Adhesive, For terminal block width: 5.08 mm

Tools

Screwdriver - SZS 0,6X3,5 - 1205053



Actuation tool, for ST terminal blocks, insulated, also suitable for use as a bladed screwdriver, size: 0.6 x 3.5 x 100 mm, 2-component grip, with non-slip grip

Insertion bridge - EBP 2- 5 - 1733169



Insertion bridge, fully insulated, for plug connectors with 5.0 or 5.08 mm pitch, no. of positions: 2

Drawings

PCB terminal block - MKDS 2,5/ 6-5,08 - 1730434

Drilling diagram

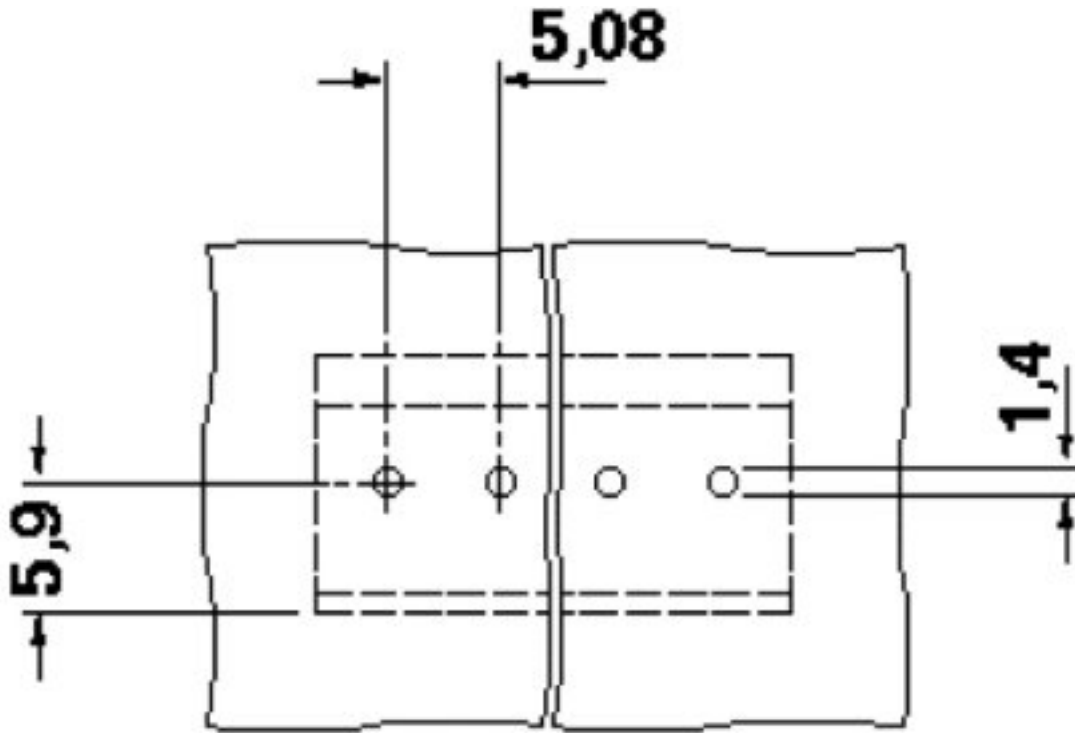

Dimensioned drawing

