

TOP VIEW OF BOX

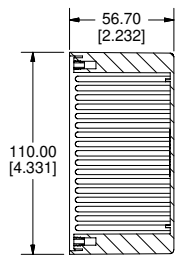

SECTION B-B

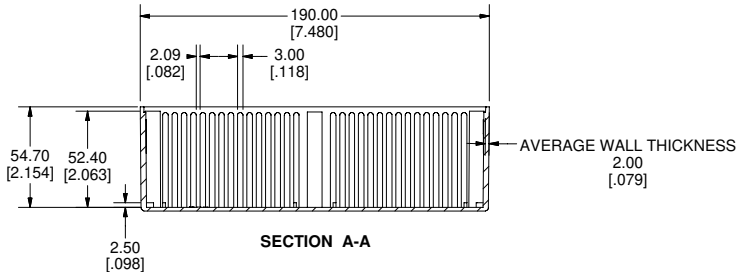

SECTION A-A

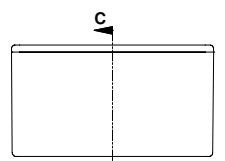

END VIEW OF ASSEMBLY

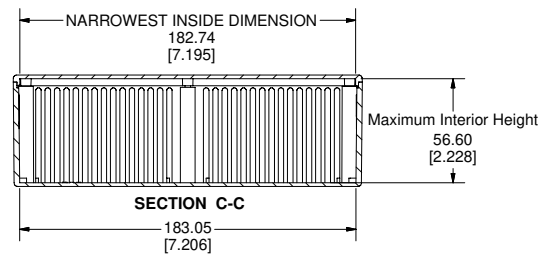

SECTION C-C

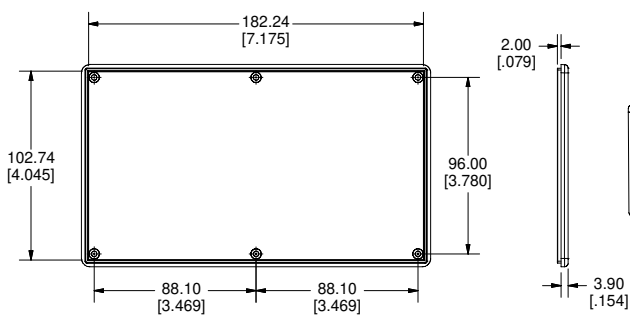

BOTTOM OF LID

SIDE OF LID

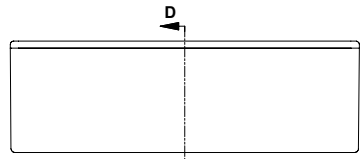

SIDE VIEW OF ASSEMBLY

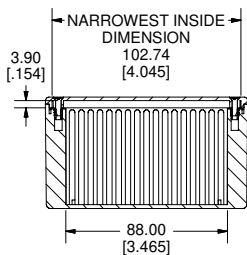

SECTION D-D

Note:  
Enclosures can be Factory Modified ( Milling, Drilling, Printing etc. )  
Contact Factory [mjm@hammondmfg.com](mailto:mjm@hammondmfg.com) for quotes  
Solid models of this enclosure available in STEP or IGES Format.

PART NUMBERS		
1591E Enclosures		
Material	Colour	Part Number
FR ABS UL94 - V0	Beige	1591EBG
	Black	1591EBK
	Blue	1591EBU
	Grey	1591EGY
GP ABS UL94 - HB	Black	1591ESBK
	Grey	1591ESGY
Translucent Polycarbonate	Ice Blue	1591ETBU
	IR Red	1591ETRD
	Crystal Clear	1591ETCL
Accessories		
Description	Part Number	
Universal Use	PC Board Card Adapters	See Accessories Section
	Clear Lids - clear, flame retardant polycarbonate - Lid ONLY	1591EC
FR ABS	Replacement Screws, Flat Head Phillips Nickel Plated Pkg of 100	1591MS100 1591TS100
	Self Tapping Pkg of 100	1591TS100BK ( Black )
Recommended Torque on Fasteners (no lubrication)		
	M3 - 0.5 x 10mm Screws	30-40 cN*m
	#4 x 0.5 Screws	30-40 cN*m

**HAMMOND  
MANUFACTURING™**

**1591E**  
[www.hammondmfg.com](http://www.hammondmfg.com)