



TAOGLAS®



Datasheet

GPS L1 & Bluetooth / 2.4GHz Wi-Fi Embedded 2in1 Ceramic Loop Antenna

Part No:
GWLA.05

Features:

- 10 * 3.2 * 1.5mm
- GPS L1 and Wi-Fi 2.4GHz Applications
- Simplifies GPS/2.4GHz Circuits
- Two Separate Feeds on one Chip Antenna
- Low Profile, Small Footprint Antenna
- SMD Surface-mount
- RoHS & REACH Compliant

1.	Introduction	3
2.	Specifications	5
3.	Antenna Characteristics	7
4.	Radiation Patterns	12
5.	Mechanical Drawing	15
6.	Antenna Integration Guide	16
7.	Packaging	22
8.	Solder Reflow Profile	23
9.	Application Note	24
<hr/>		
	Changelog	32

Taoglas makes no warranties based on the accuracy or completeness of the contents of this document and reserves the right to make changes to specifications and product descriptions at any time without notice. Taoglas reserves all rights to this document and the information contained herein. Reproduction, use or disclosure to third parties without express permission is strictly prohibited.



1. Introduction



The Taoglas GWLA.05, GPS L1 /2.4GHz embedded loop antenna is a high efficiency, miniature SMD, edge mounted ceramic antenna for GPS and 2.4GHz Wi-Fi, WLAN, Zigbee, Bluetooth, and 802.11 applications. Customers can use this antenna for GPS and 2.4GHz (Wi-Fi or Bluetooth) modules, rather than using two separate antennas. The GWLA.05 has two separate antenna feeds, making it the ideal choice for applications where there is limited PCB space. The GWLA.05 uses the main PCB as its ground plane, thereby maintaining good efficiency despite its small size. It can be tuned for different PCB sizes/environments by simply changing the values of the matching circuit. It is ideally mounted on the center edge of a ground-plane.

At 10*3.2*1.5mm, the GWLA.05 is one of the smallest combination embedded antennas available worldwide. This antenna is delivered on tape and reel.

Typical Applications – where both GPS and 2.4GHz are required:

- Navigation or Position Tracking Systems
- Tablet PCs
- Gateways and Routers
- UAV Communication Systems
- Handheld Devices
- OBD Devices
- Mobile Cameras

Many module manufacturers specify peak gain limits for any antennas that are to be connected to that module. Those peak gain limits are based on free-space conditions. In practice, the peak gain of an antenna tested in free-space can degrade by at least 1 or 2 dBi when put inside a device. So ideally you should go for a slightly higher peak gain antenna than mentioned on the module specification to compensate for this effect, giving you better performance.

Upon testing of any of our antennas with your device and a selection of appropriate layout, integration technique, or cable, Taoglas can make sure any of our antennas' peak gain will be below the peak gain limits. Taoglas can then issue a specification and/or report for the selected antenna in your device that will clearly show it complying with the peak gain limits, so you can be assured you are meeting regulatory requirements for that module.

For example, a module manufacturer may state that the antenna must have less than 2 dBi peak gain, but you don't need to select an embedded antenna that has a peak gain of less than 2 dBi in free-space. This will give you a less optimized solution. It is better to go for a slightly higher free-space peak gain of 3 dBi or more if available. Once that antenna gets integrated into your device, performance will degrade below this 2 dBi peak gain due to the effects of GND plane, surrounding components, and device housing. If you want to be absolutely sure, contact Taoglas and we will test. Choosing a Taoglas antenna with a higher peak gain than what is specified by the module manufacturer and enlisting our help will ensure you are getting the best performance possible without exceeding the peak gain limits.

2. Specifications

GNSS Frequency Bands					
GPS	L1 1575.42 MHz	L2 1227.6 MHz	L5 1176.45 MHz		
	■	□	□		
GLONASS	G1 1602 MHz	G2 1248 MHz	G3 1207 MHz		
	■	□	□		
Galileo	E1 1575.24 MHz	E5a 1176.45 MHz	E5b 1201.5 MHz	E6 1278.75 MHz	
	■	□	□	□	
BeiDou	B1C 1575.42 MHz	B1I 1561 MHz	B2a 1176.45 MHz	B2b 1207.14 MHz	B3 1268.52 MHz
	■	■	□	□	□
QZSS (Regional)	L1 1575.42 MHz	L2C 1227.6 MHz	L5 1176.45 MHz	L6 1278.75e6	
	■	□	□	□	
IRNSS (Regional)	L5 1176.45 MHz				
	□				
SBAS	L1/E1/B1 1575.42 MHz	L5/B2a/E5a 1176.45 MHz	G1 1602 MHz	G2 1248 MHz	G3 1207 MHz
	■	□	■	□	□

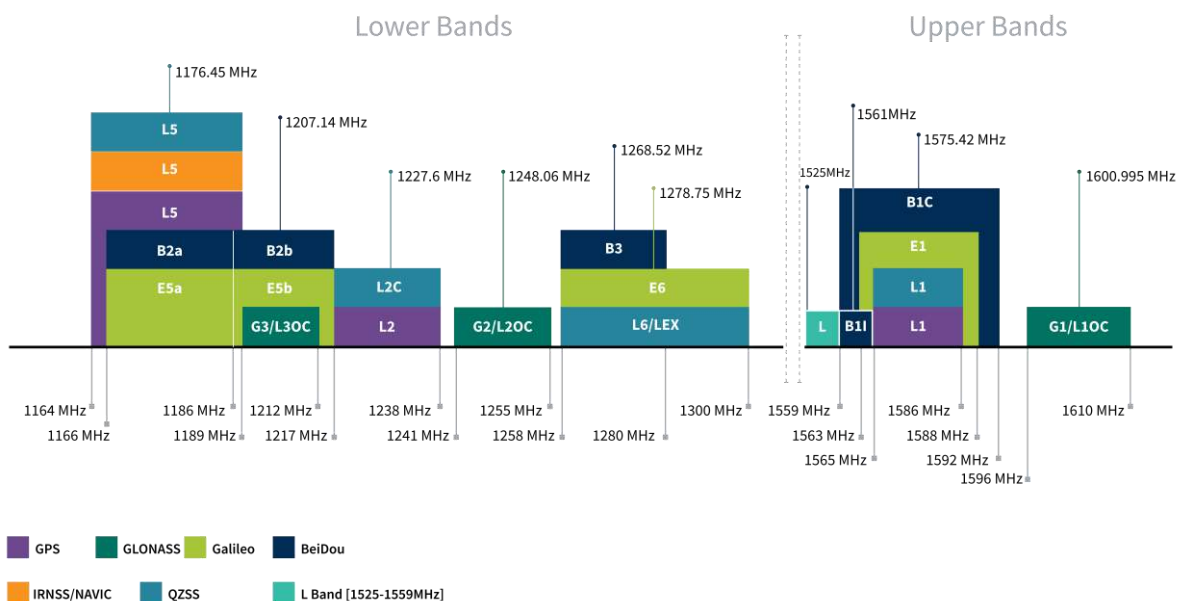

Electrical		
Application Bands	GPS L1	Wi-Fi / Bluetooth
Frequency (MHz)	1575.42	2400~2500
Ground plane size	80 x 40mm	80 x 40mm
Peak Gain (dBi)	-0.87	1.15
Efficiency (%)	63.21	49.3
Return Loss (dB)	<-15	<-5
Isolation (dB)	<-30	<-15
Impedance	50 Ω	
Polarization	Linear	
Input Power	10W	
Mechanical		
Dimensions	10 x 3.2 x 1.5mm	
Ground plane	80 x 40 or 30 x 15mm	
Weight	0.19g	
Environmental		
Operating Temperature	-40°C to 85°C	
Storage Temperature	-25°C to 85°C	
Relative Humidity	20% to 70%	
Moisture Sensitivity Level (MSL)	3 (168 Hours)	

3. Antenna Characteristics

3.1 Return Loss – GPS Band

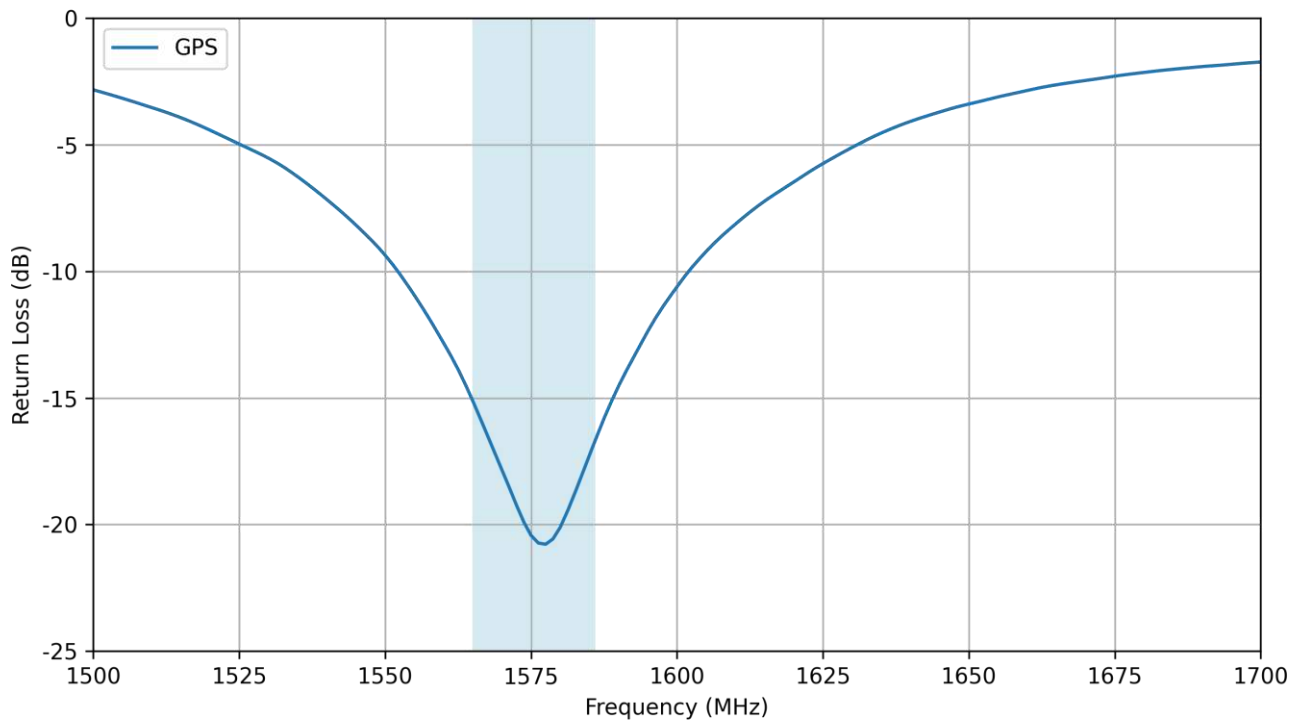

3.2 Efficiency – GPS Band

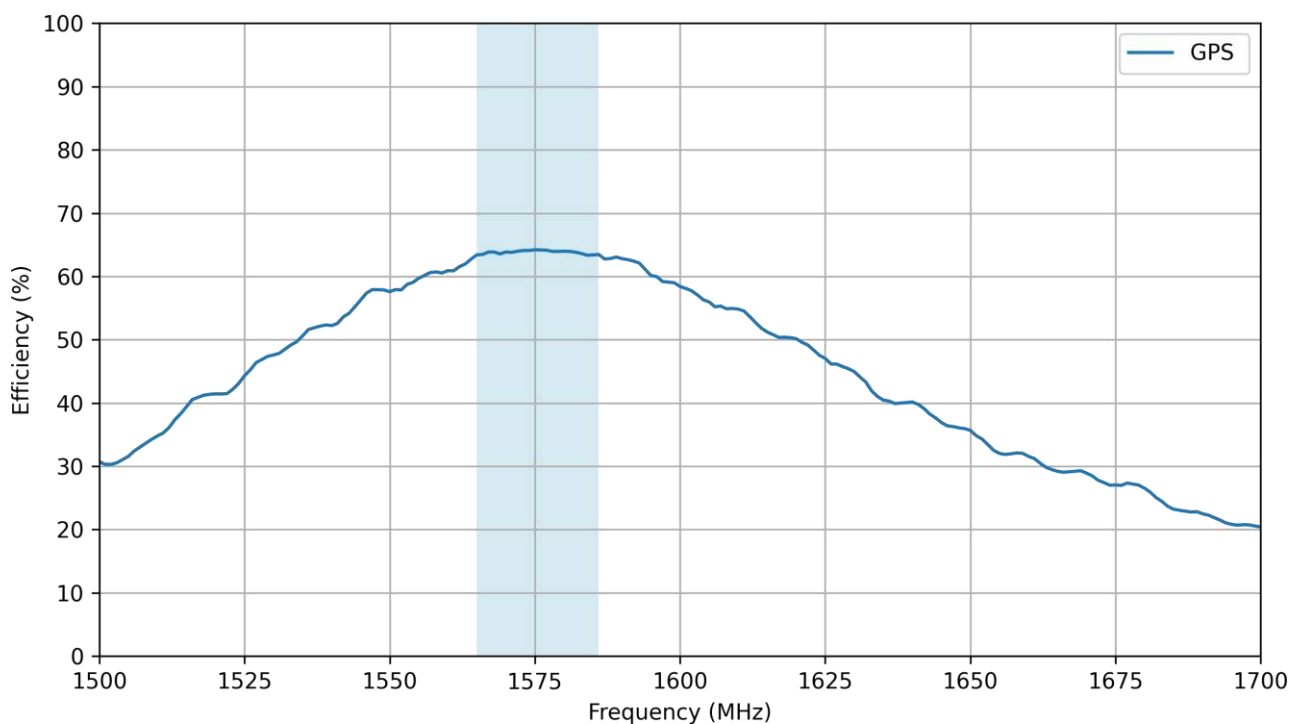

3.3 Average Gain – GPS Band

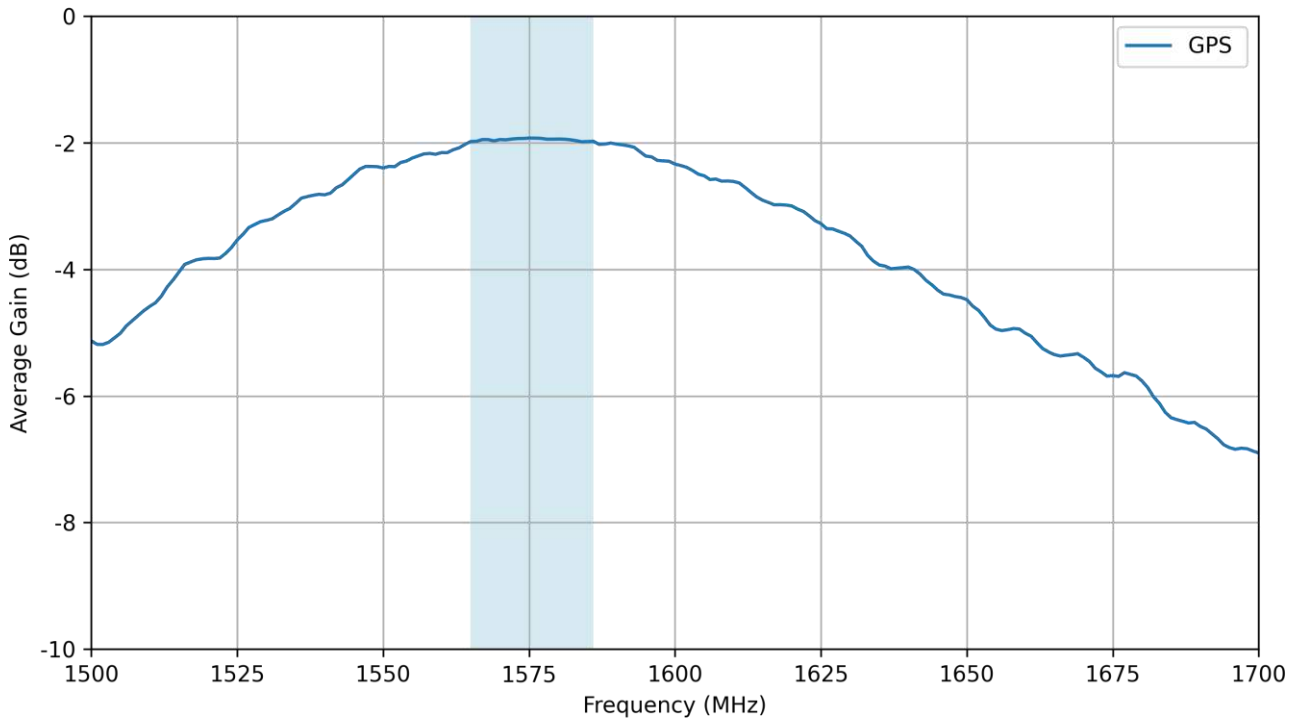

3.4 Peak Gain – GPS Band

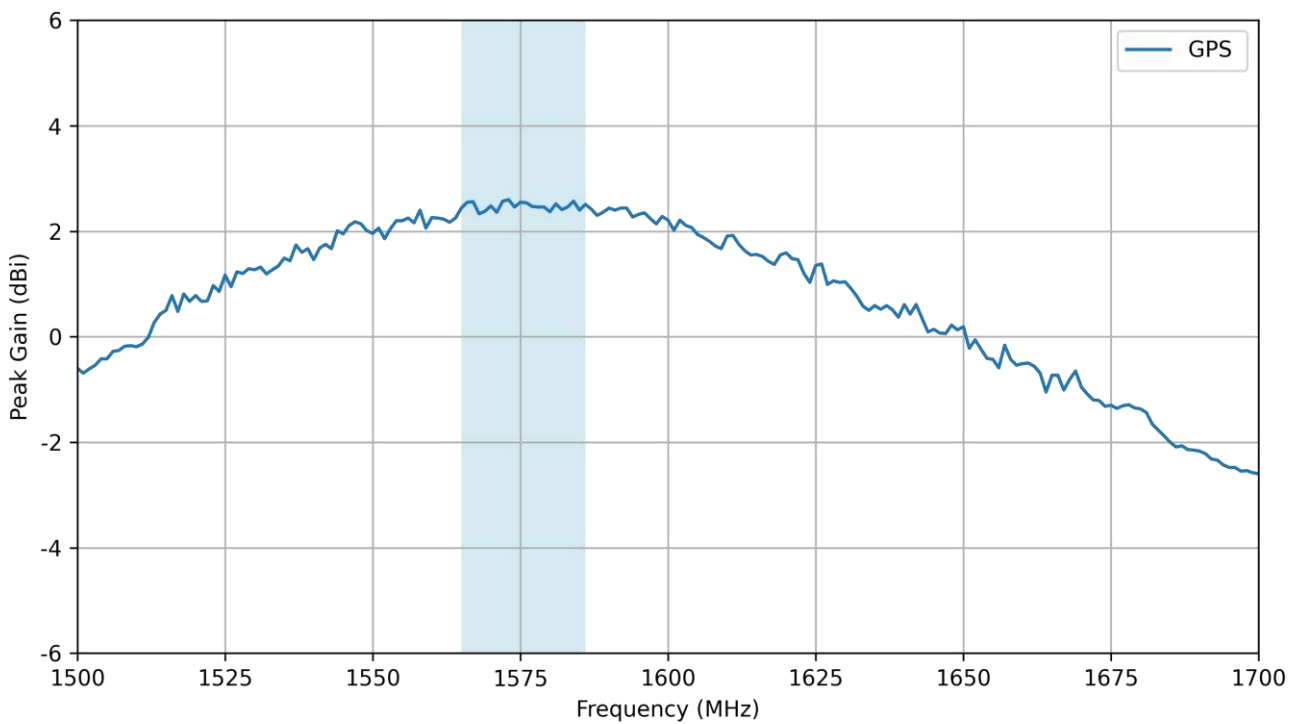

3.5 Return Loss – Wi-Fi

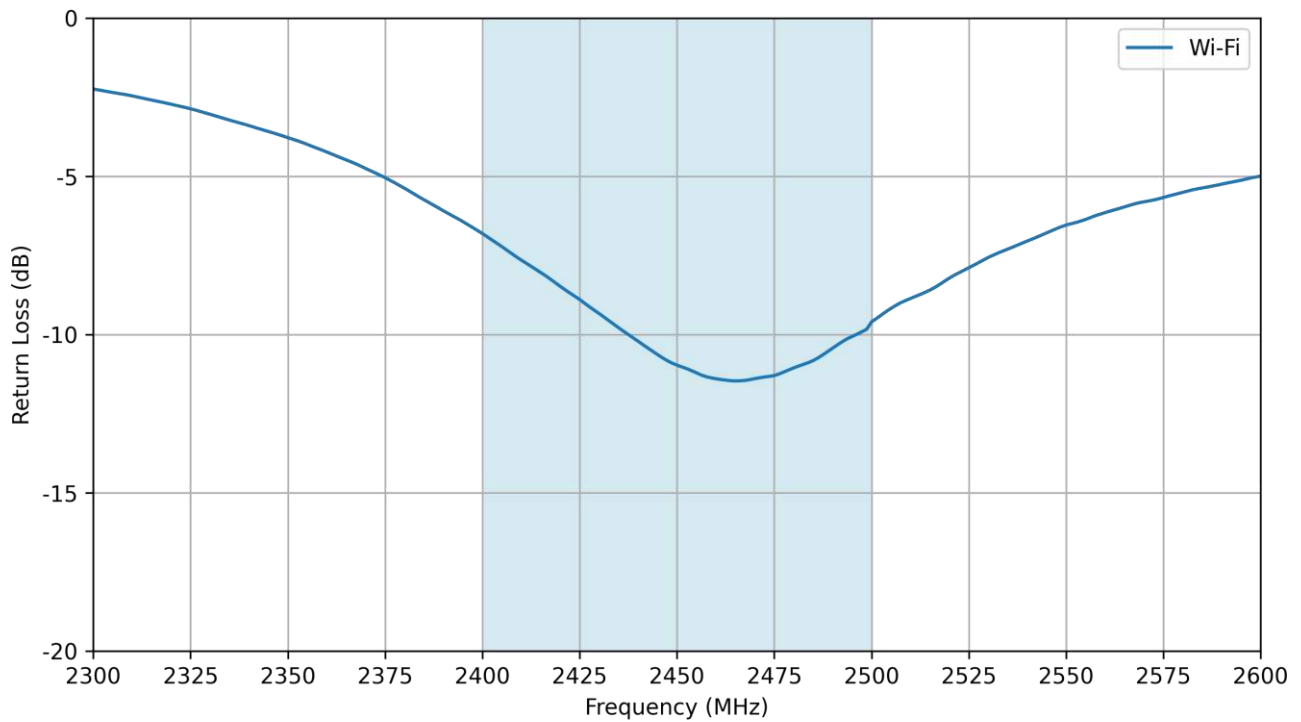

3.6 Efficiency – Wi-Fi

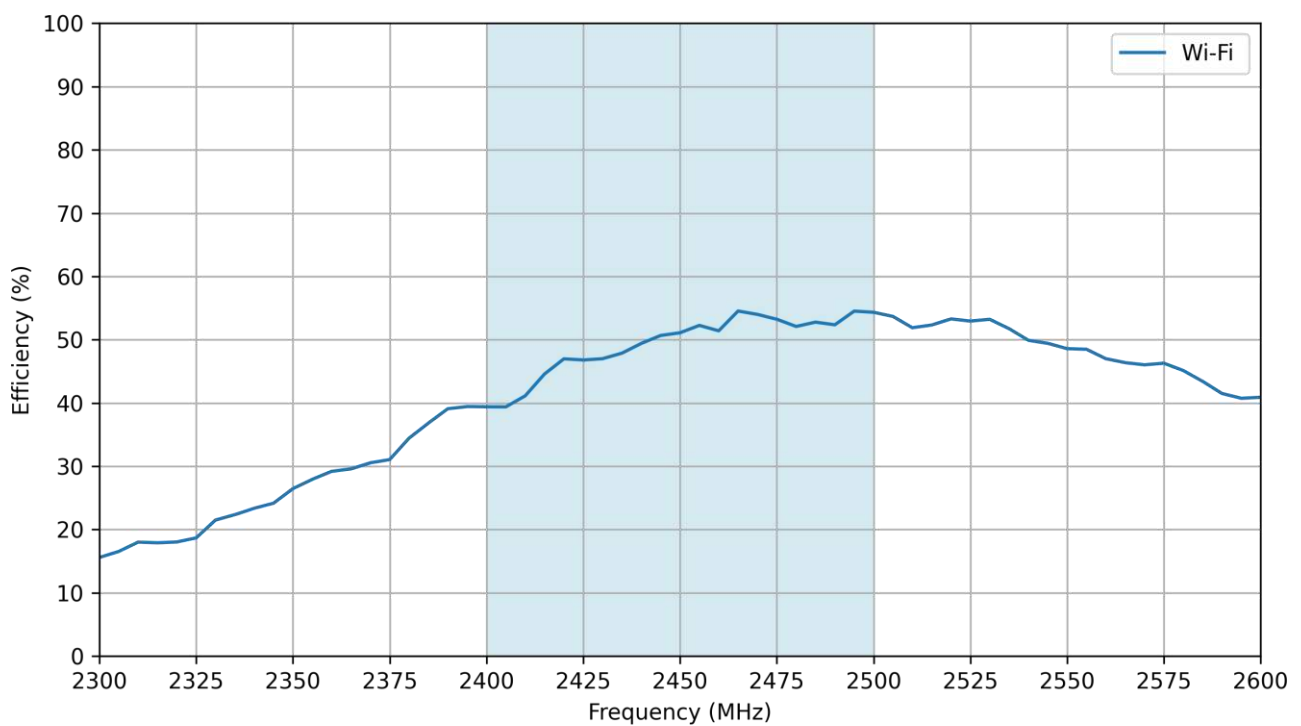

3.7 Average Gain – Wi-Fi

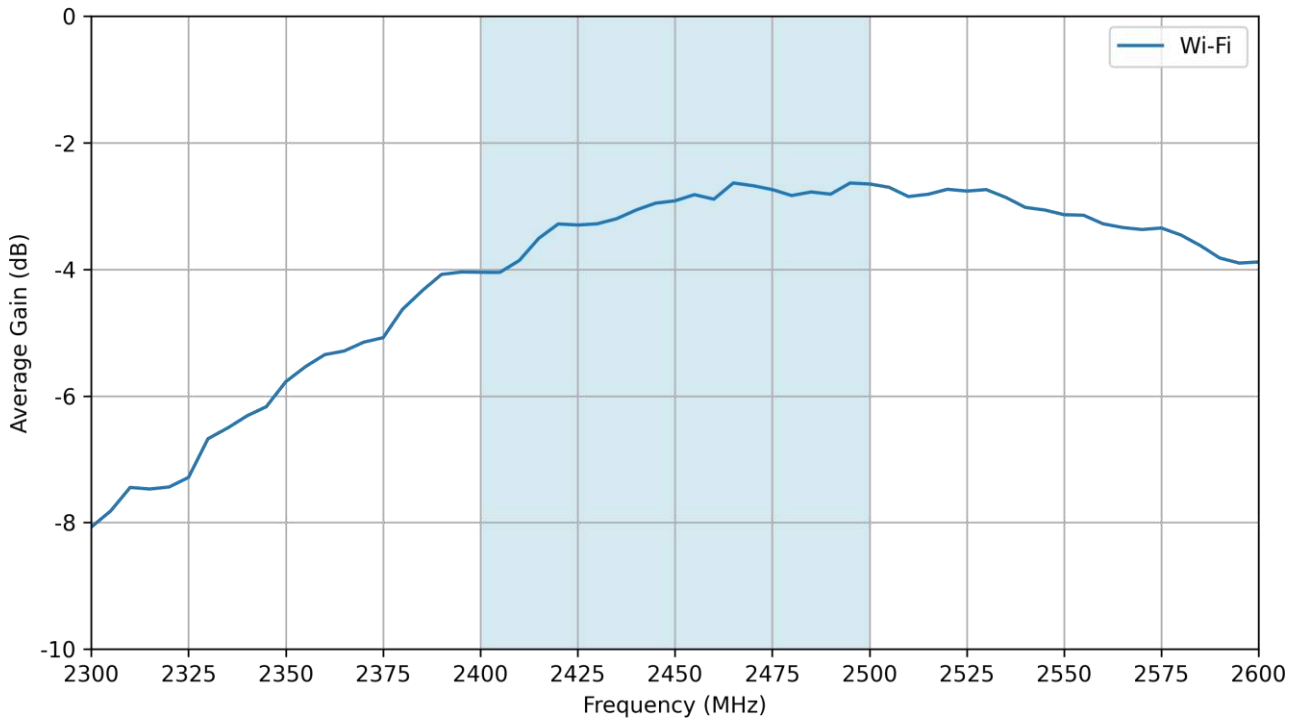

3.8 Peak Gain – Wi-Fi

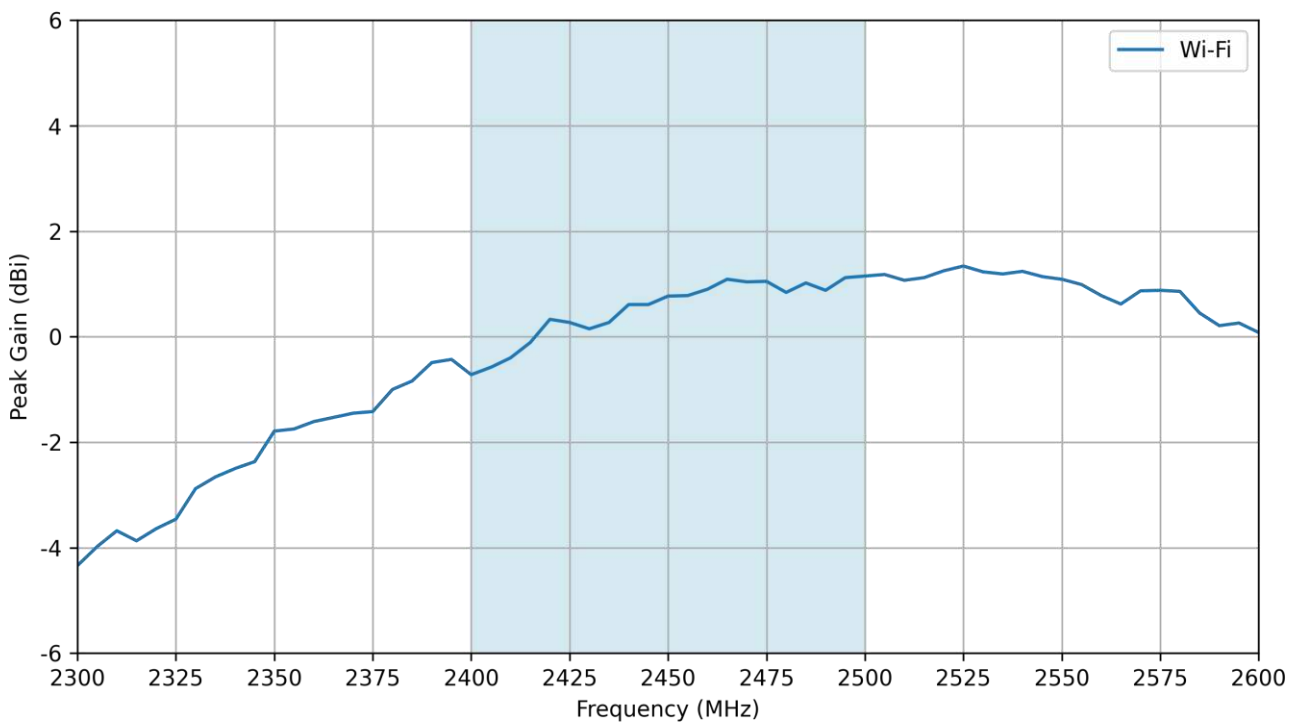

3.9 Isolation between Wi-Fi and GPS Antennas

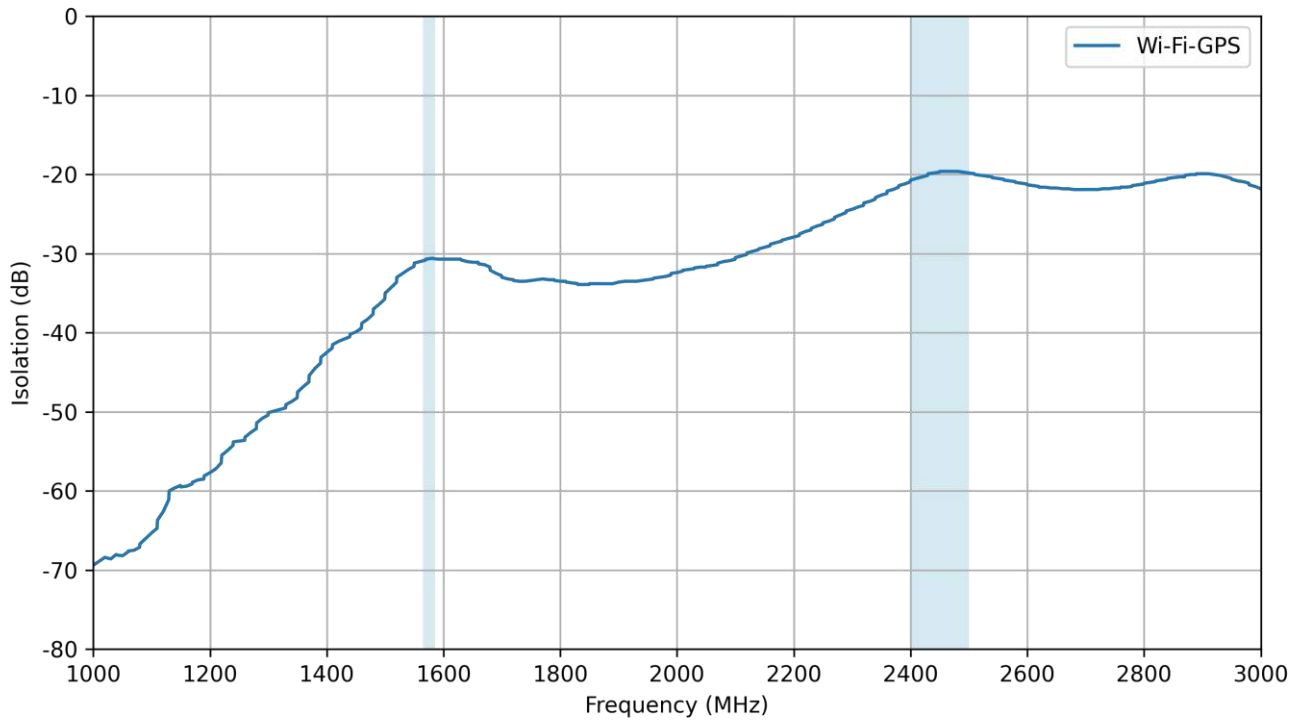

4. Radiation Patterns

4.1 Test Setup



Anechoic Chamber Setup

4.1 GPS Patterns at 1575 MHz

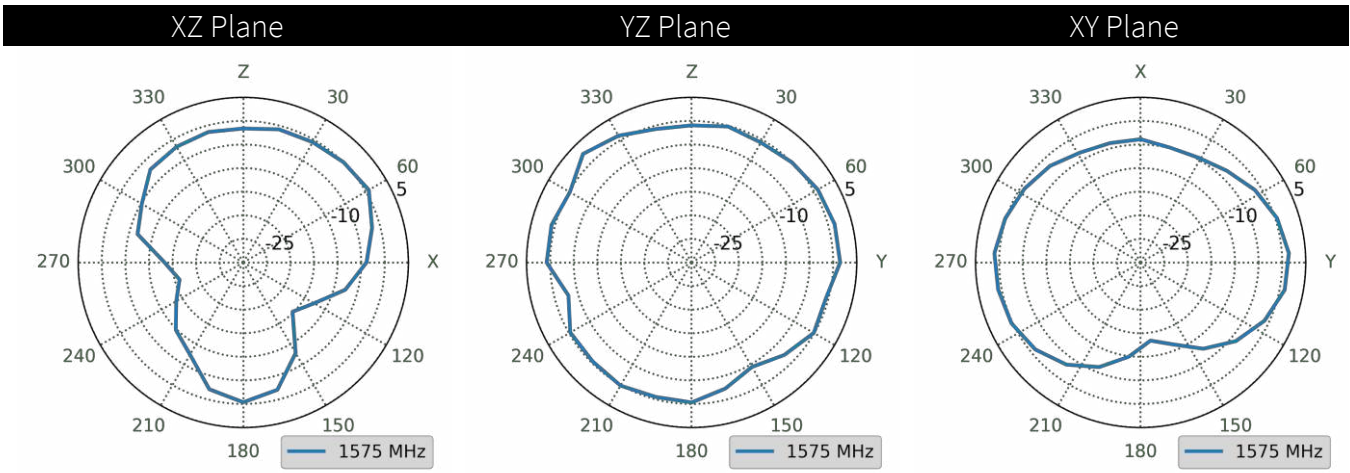
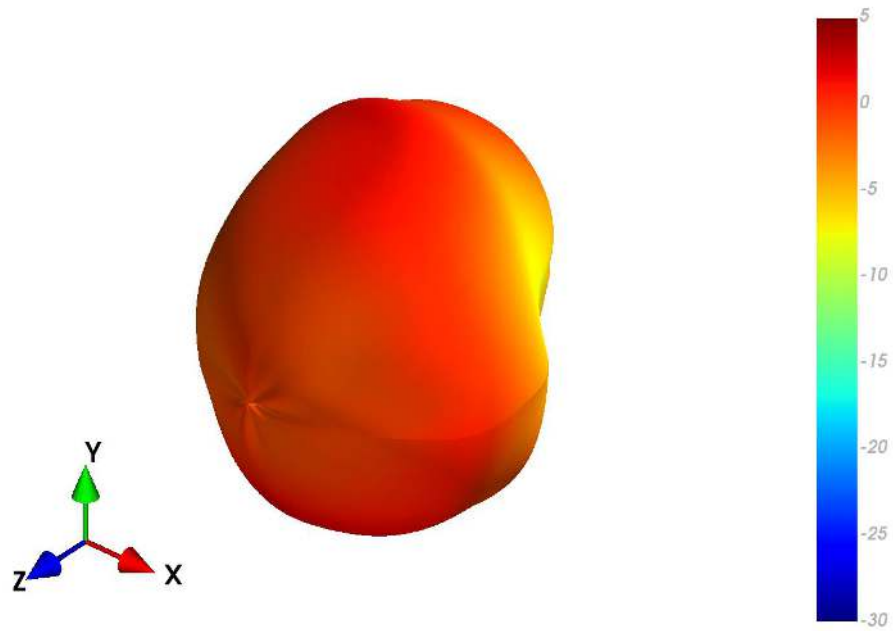

4.2 Wi-Fi Patterns at 2400 MHz

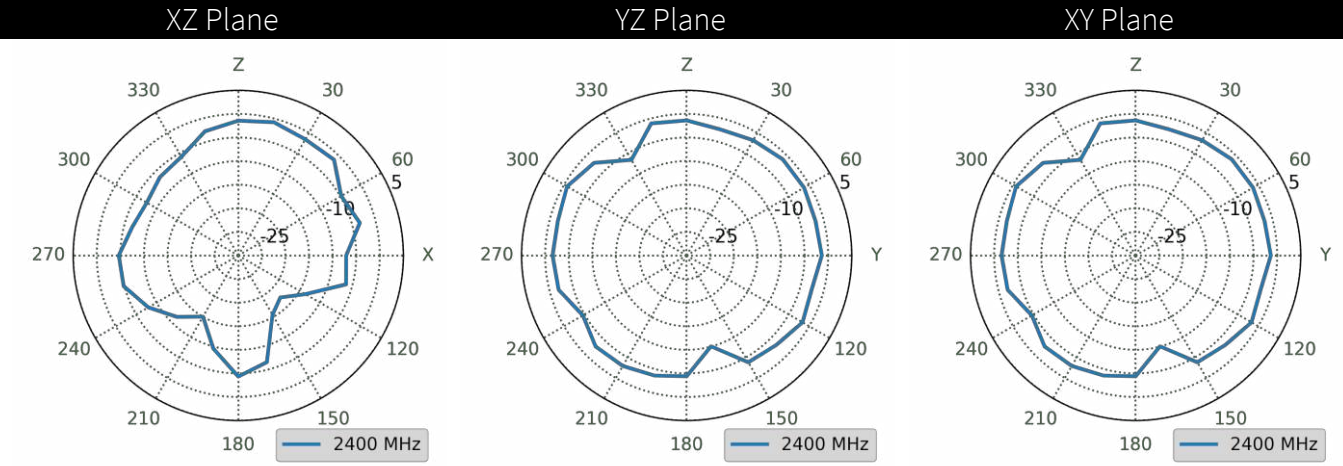
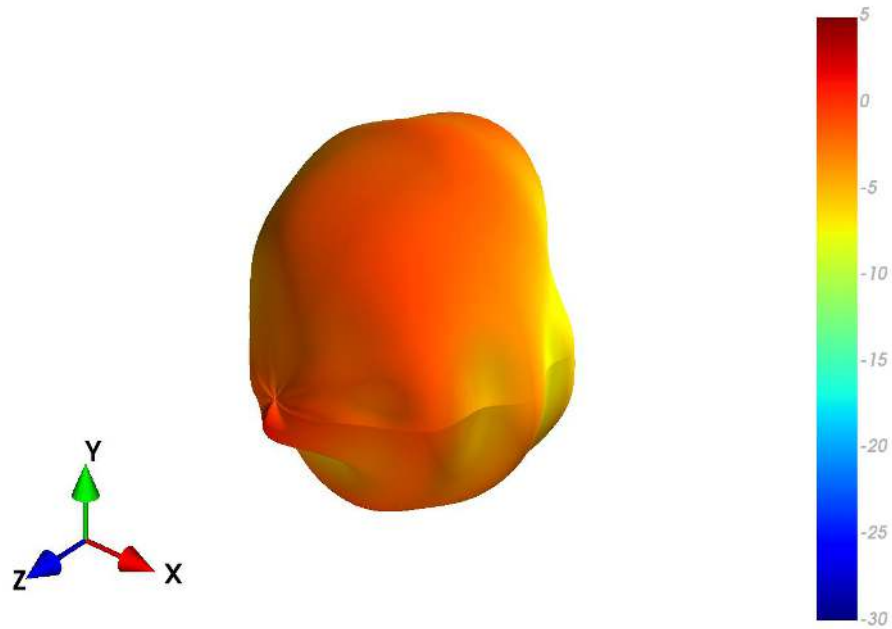

4.3 Wi-Fi Patterns at 2450 MHz

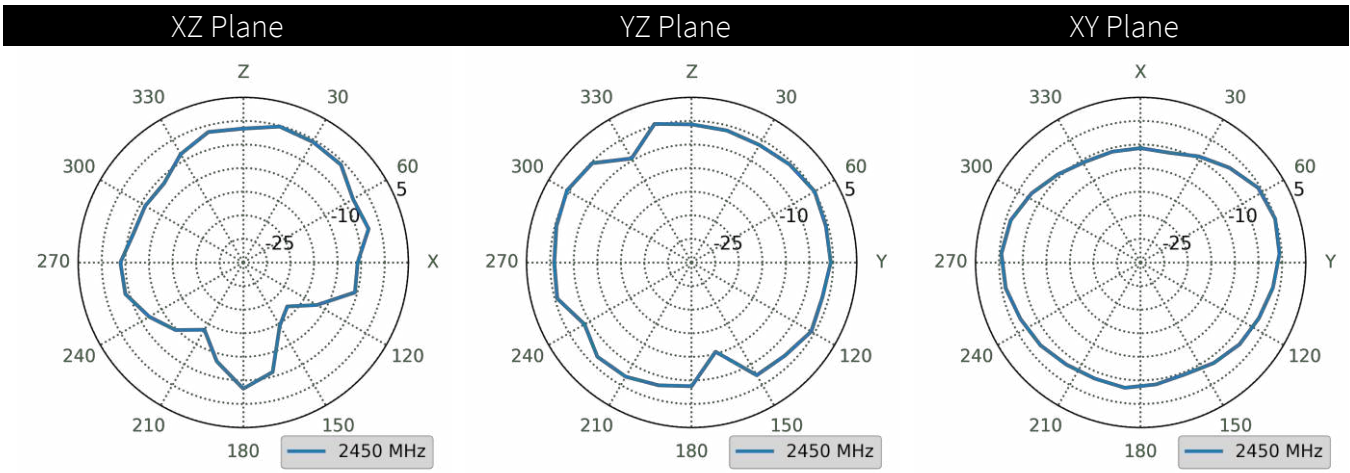
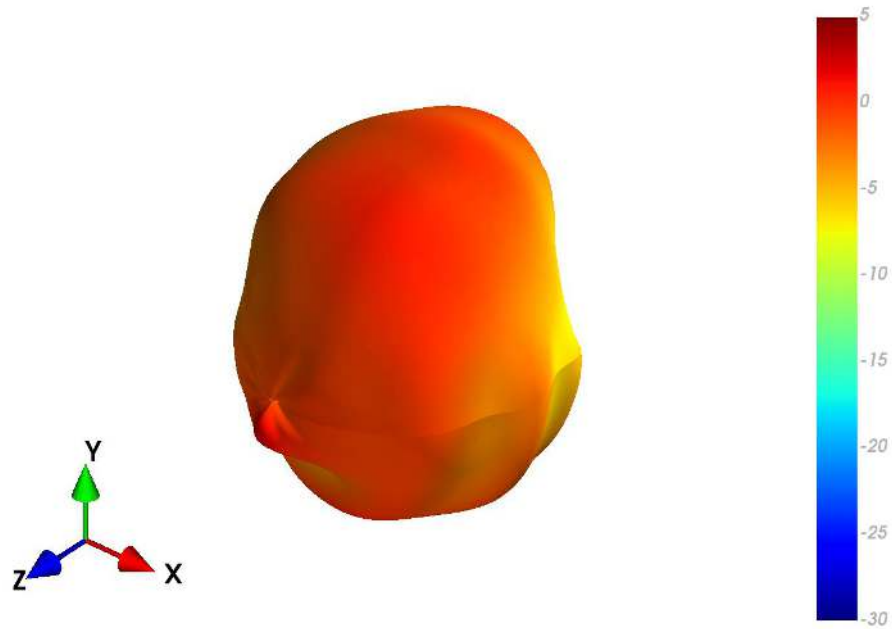

4.4 Wi-Fi Patterns at 2500 MHz

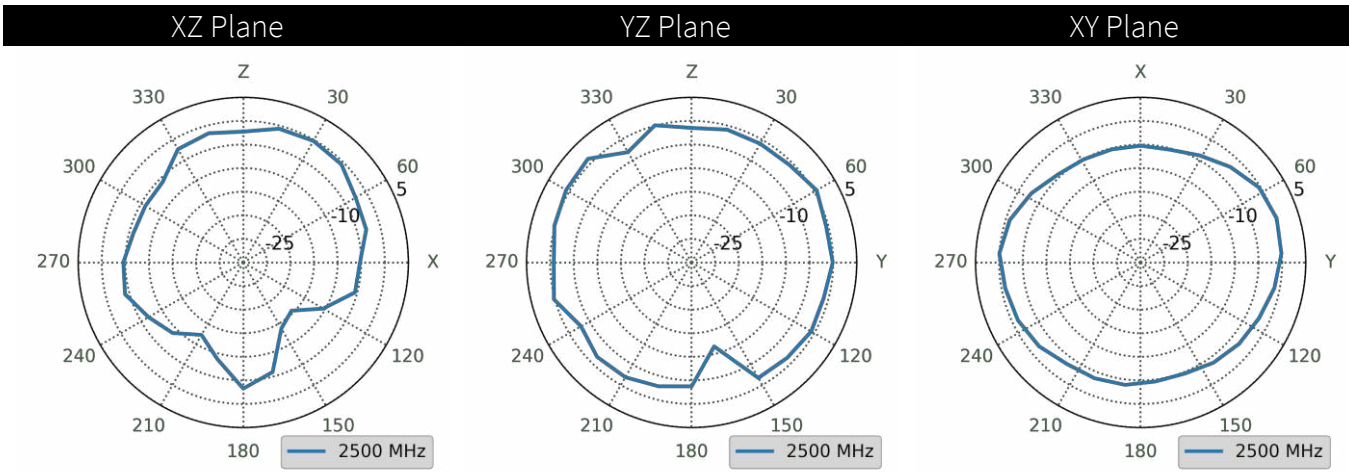
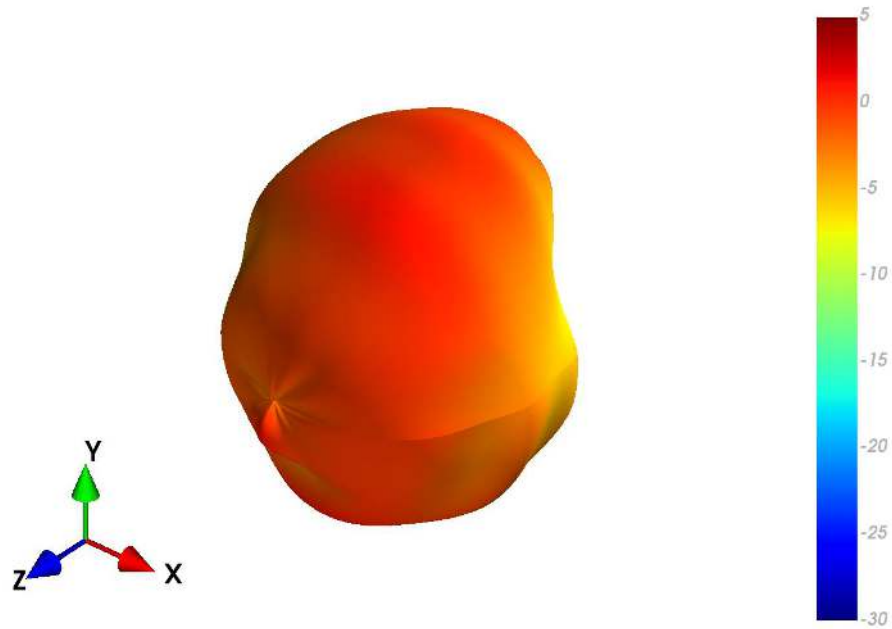

5. Mechanical Drawing (Units: mm)



TOP VIEW



SIDE VIEW

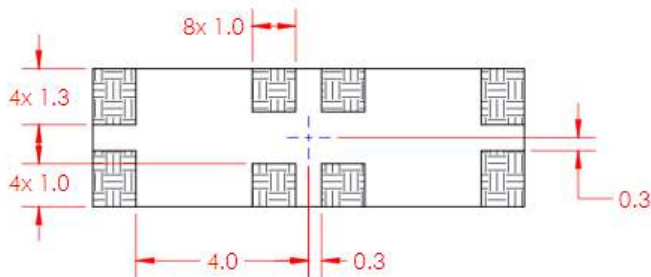

BOTTOM VIEW

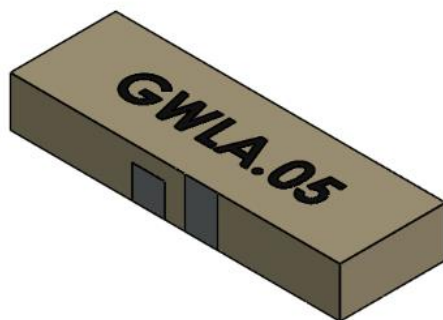

MODEL VIEW

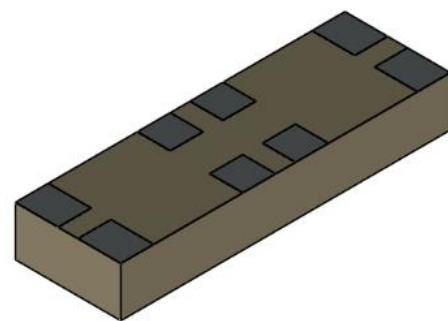

MODEL VIEW

6. Antenna Integration Guide



6.1 Schematic Symbol and Pin Definition

The circuit symbol for the antenna is shown below. The antenna has 8 pins with only 7 pins (Pin 1,2,3,4,5,6 and 7) as functional. Pin 8 is for mechanical strength.

Pin	Description
1	Wi-Fi Feed
2, 3, 5, 6, 7	GND
4	GPS Feed
8	Mechanical, Not Connected

TAOGLAS_GWLA.05 ANT1

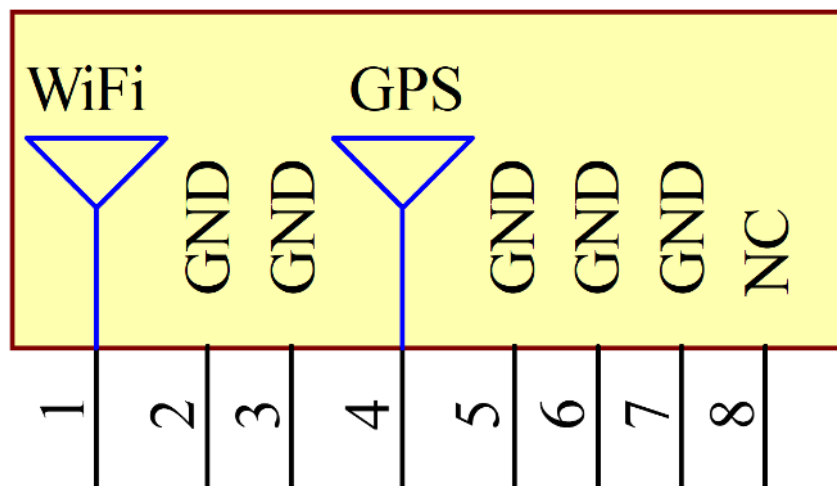

6.2 Antenna Integration

For any given PCB size, the antenna should ideally be placed on the PCB's centre edge of the longest side, to take advantage of the ground plane. Optimized matching components can be placed as shown.



Topside w/ solder mask

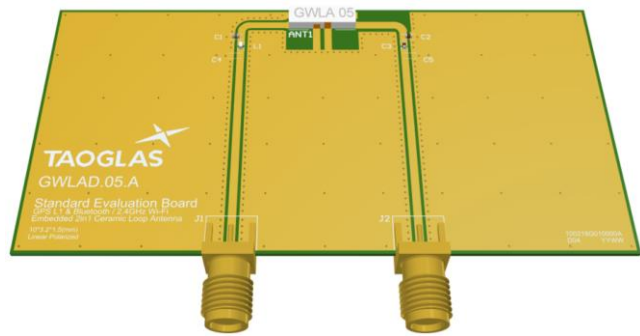

Topside w/o solder mask

6.3 PCB Layout

The footprint and clearance on the PCB must meet the layout drawing in section 6.7. Note the placement of the optimized components. C2 is placed as close as possible to the GPS feed (pad 4) & C1 is placed in a mirrored position to the Wi-Fi feed (pad 1), both should be outside the copper keep out area. L1 & C3 are then placed tightly in series after that. C4 & C5 are optional components but the footprints are recommended in case they are needed.

Top side

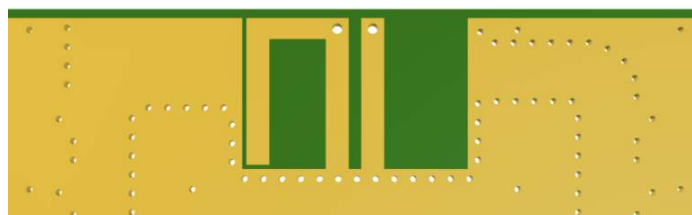
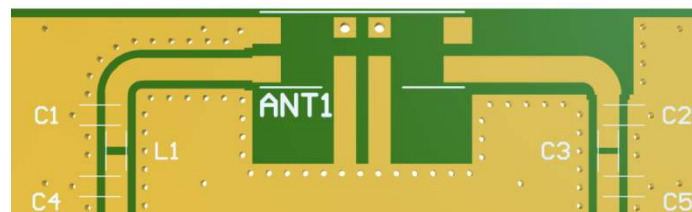

6.4 PCB Clearance

Below shows the antenna footprint and clearance through ALL layers on the PCB. Only the antenna pads and connections to Wi-Fi, GPS and GND are present within this clearance area (marked RED). The clearance area on the top side extends to 7.2mm in length and 18.735mm in width from the centre edge on the long side of the PCB. The clearance area on the bottom side extends to 7.2mm in length and 10.8mm in width from the centre edge on the long side of the PCB. This clearance area includes ALL internal layers on the PCB.

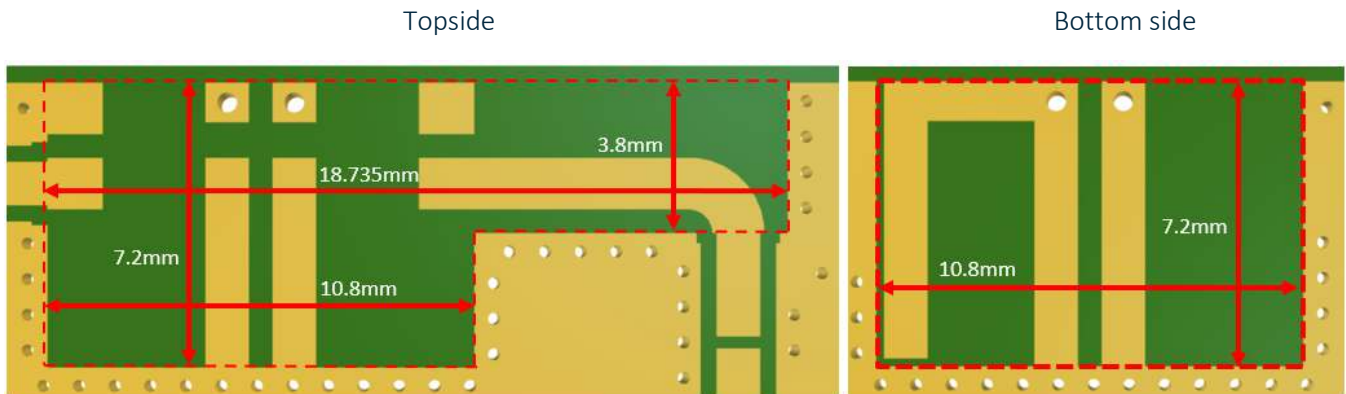

6.5 Evaluation Board



6.6 Matching Circuit

Matching components with the GWLA.05 are recommended for the antenna to have optimal performance on the evaluation board, located outside the copper keep out area in the spaces specified in the above images. Additional matching components may be necessary for your device, so we recommend incorporating extra component footprints, forming a “pi” network, between the cellular module and the edge of the ground plane.

Designator	Type	Value	Manufacturer	Manufacturer Part Number
L1	Inductor	6.8nH	TDK	MLK1005S6N8DT000
C1	Capacitor	0.7pF	Yageo	CC0402CRNPO9BNR70
C2	Capacitor	1.5pF	Murata	GRM1555C1H1R5CA01D
C3	Capacitor	1.8pF	Murata	GRM1555C1H1R8CA01D
C4, C5	Capacitor	Not Fitted	-	-

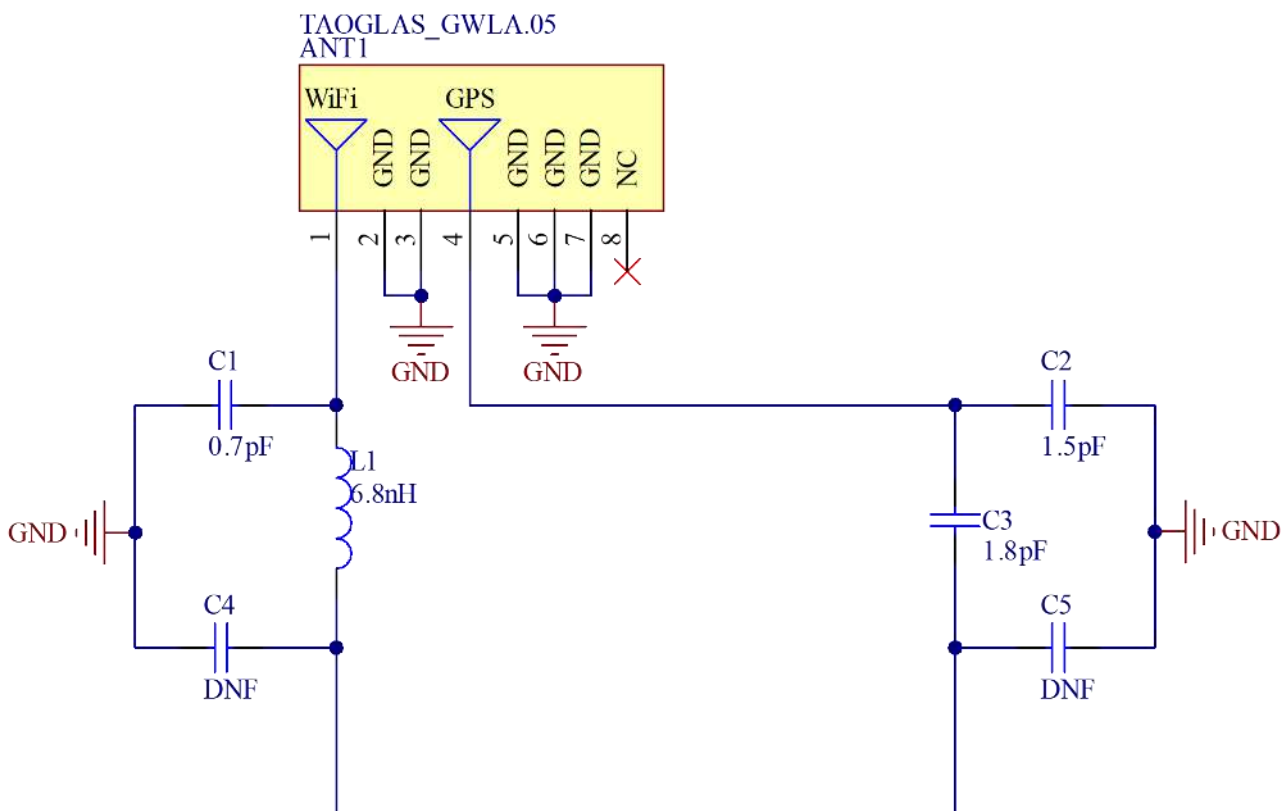

7. Packaging

2000pcs GWLA.05 per Tape & Reel
 Dimensions - $\varnothing 330 \times 28.4 \text{mm}$
 Weight - 1Kg

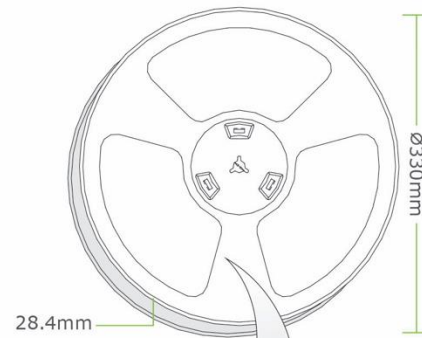

2000pcs GWLA.05 per carton
 Dimensions - $350 \times 340 \times 47 \text{mm}$
 Weight - 1.2Kg

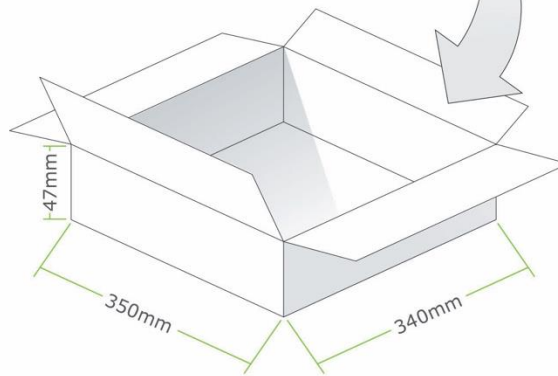

10000pcs GWLA.05 per carton
 Dimensions - $360 \times 370 \times 275 \text{mm}$
 Weight - 6.8Kg

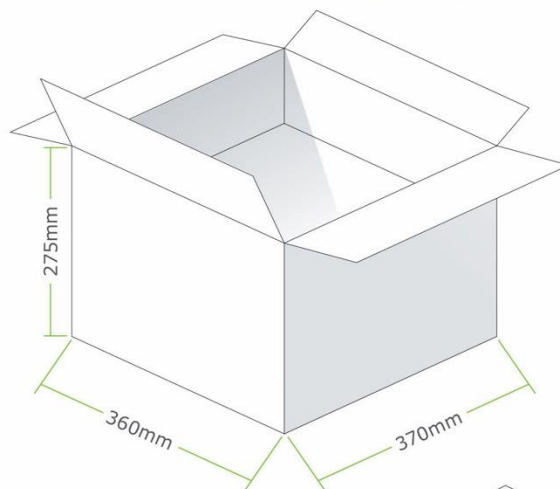

Pallet Dimensions:
 $1100 \text{mm} \times 1100 \text{mm} \times 1300 \text{mm}$
 36 Cartons per Pallet
 9 Cartons per Layer, 4 Layers

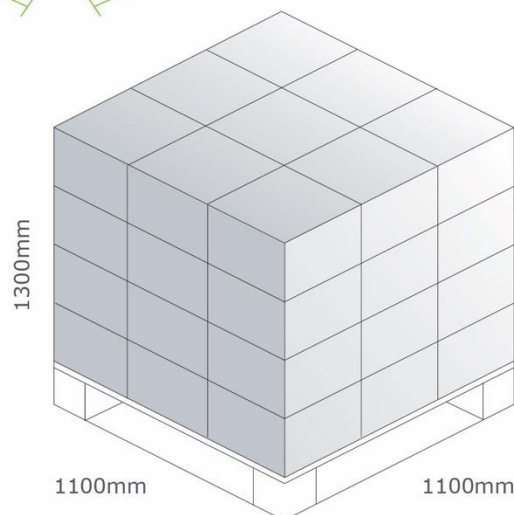

8. Solder Reflow Profile

Typical Soldering Profile for Lead-free Process:

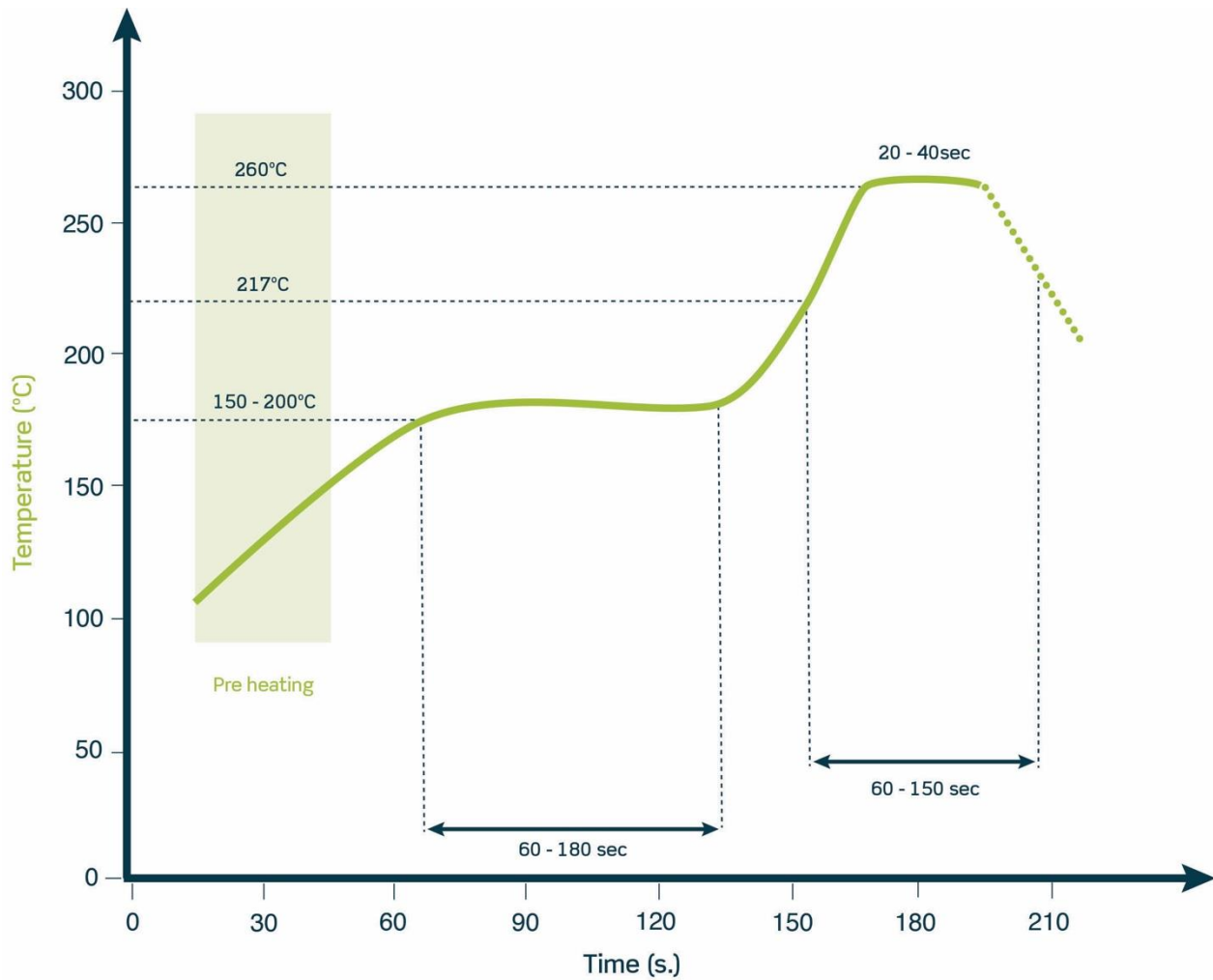

9. Application Note

This application note shows how decreasing the size of the ground plane affects the antennas performance.

Electrical		
Application Bands	GPS L1	Wi-Fi / Bluetooth
Frequency (MHz)	1575.42	2400~2500
Ground plane size	30 x 15mm	30 x 15mm
Peak Gain (dBi)	-4.66	0.24
Efficiency (%)	29.2	52
Return Loss (dB)	<-10	<-5
Isolation (dB)	<-30	<-20
Impedance	50 Ω	
Polarization	Linear	
Input Power	10W	

9.1 Return Loss – GPS Band (30 x 15mm Ground plane)

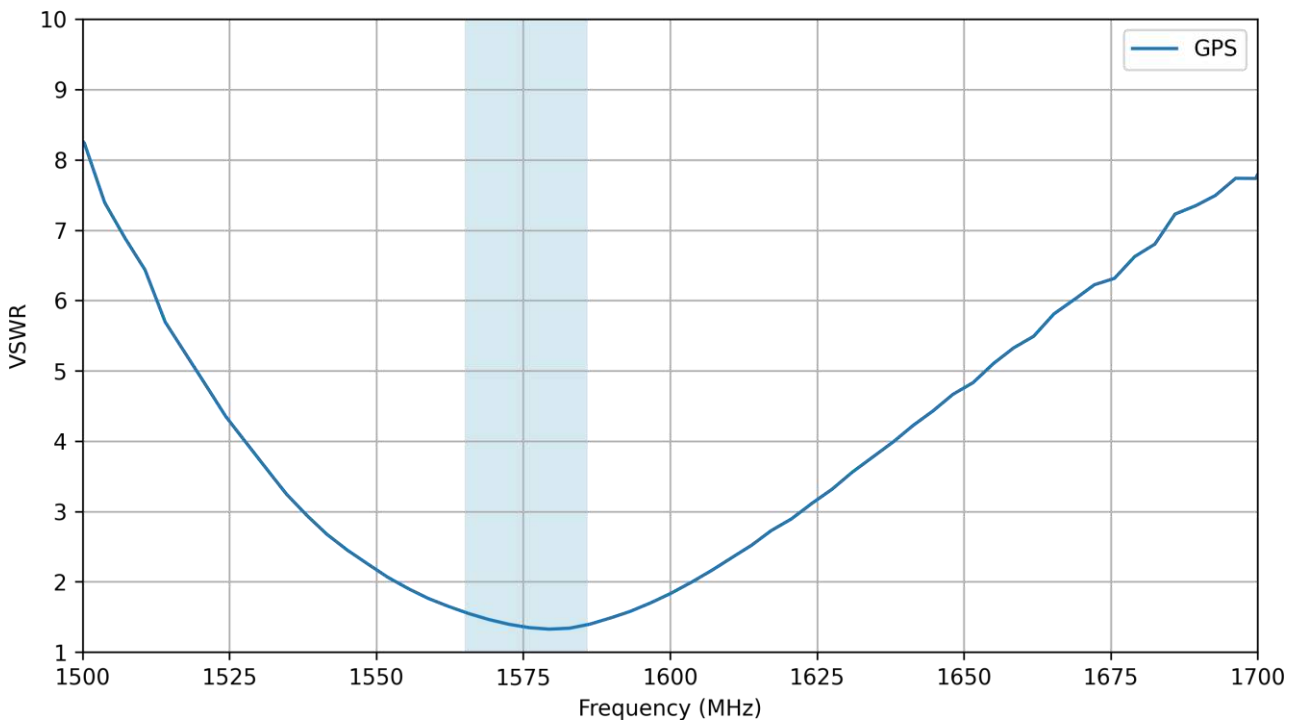

9.2 Efficiency – GPS Band (30 x 15mm Ground plane)

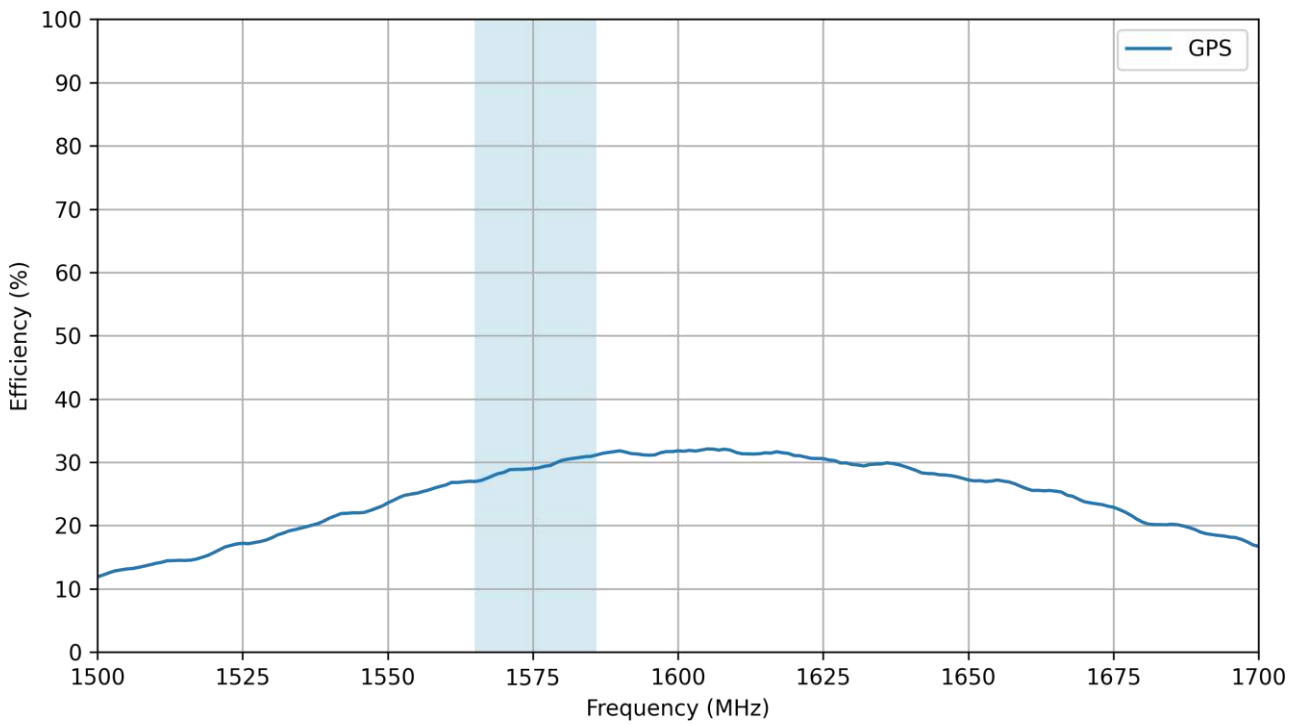

9.3 Average Gain – GPS Band (30 x 15mm Ground plane)

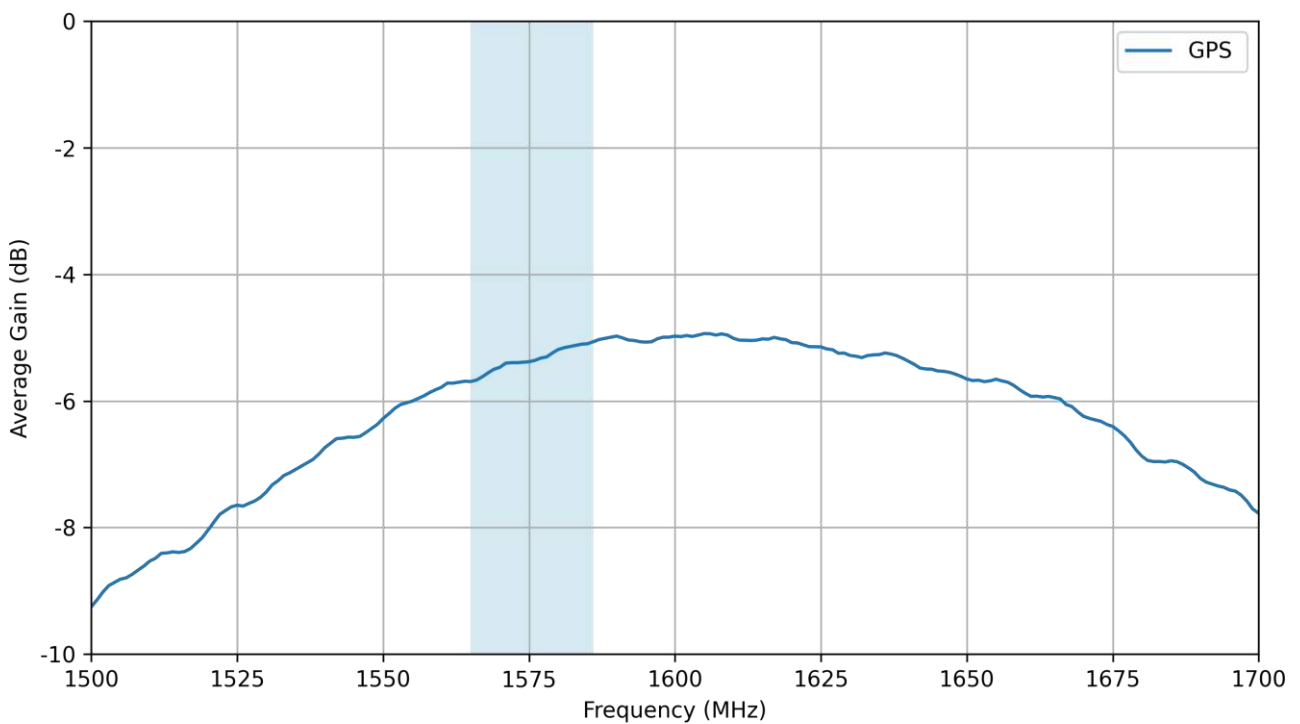

9.4 Peak Gain – GPS Band (30 x 15mm Ground plane)

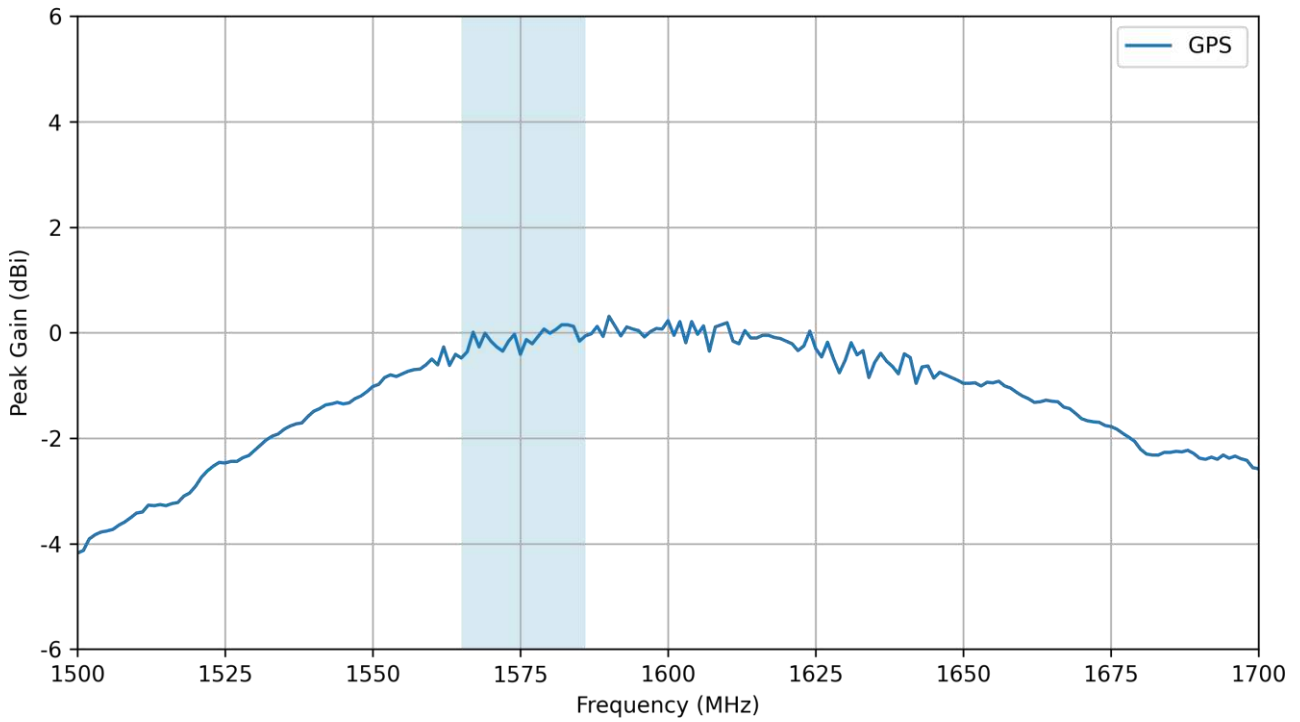

9.5 Return Loss – Wi-Fi (30 x 15mm Ground plane)

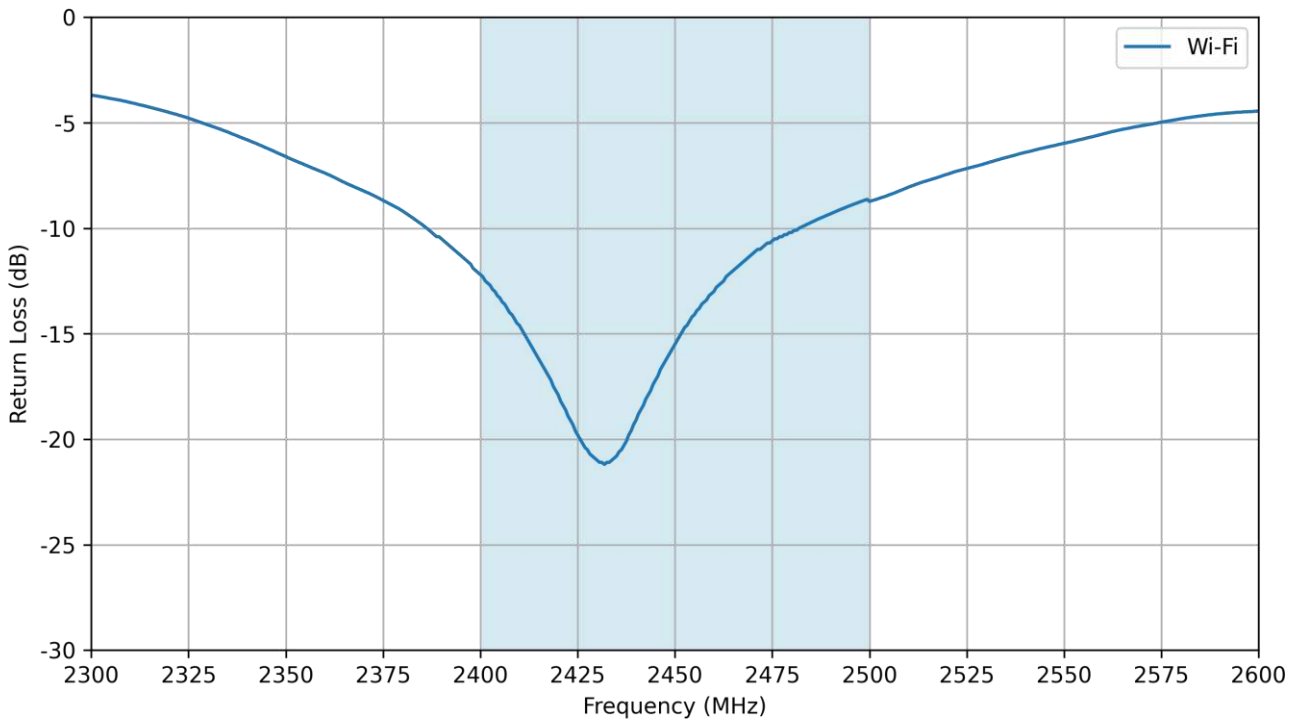

9.6 Efficiency – Wi-Fi (30 x 15mm Ground plane)

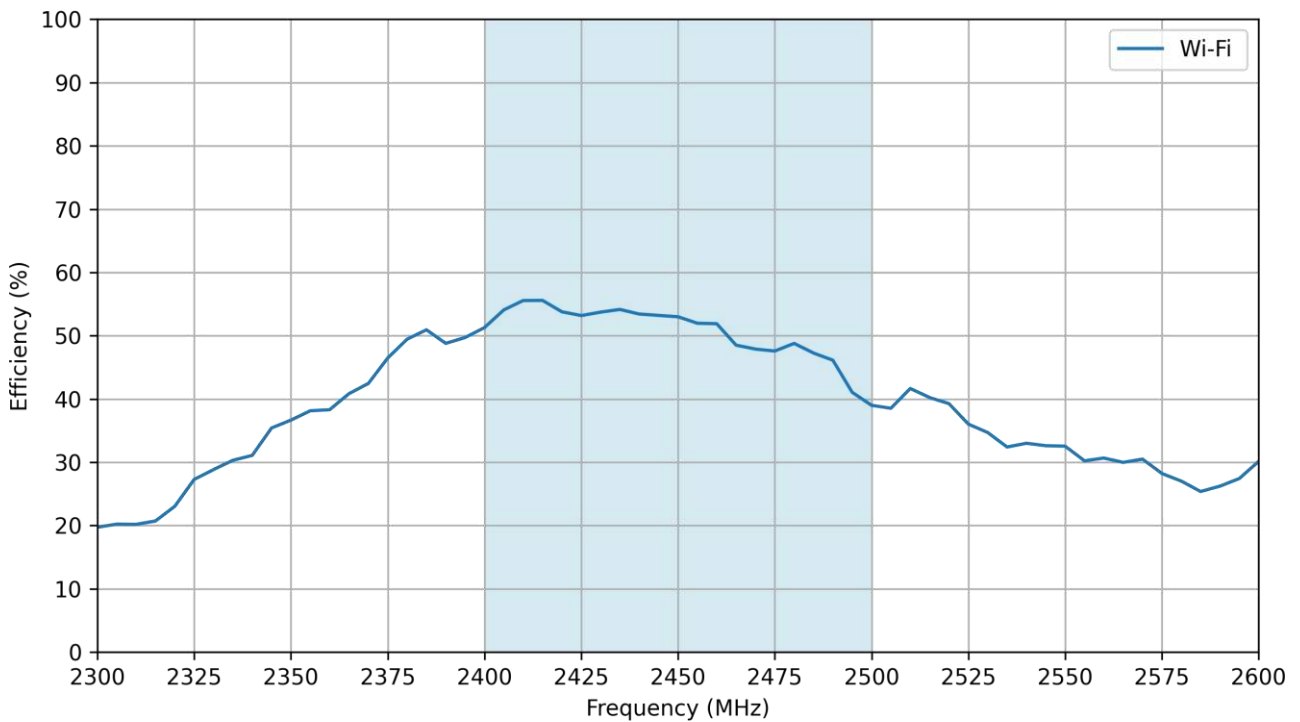

9.7 Average Gain – Wi-Fi (30 x 15mm Ground plane)

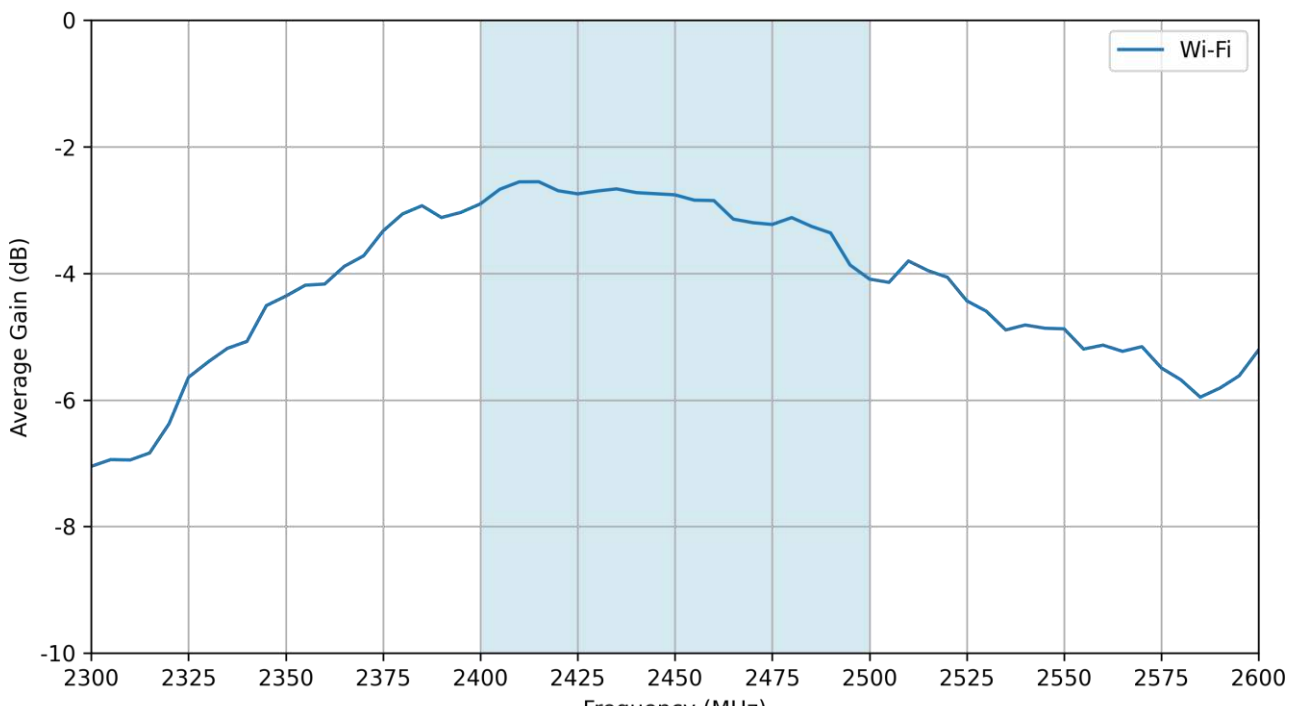

9.8 Peak Gain – Wi-Fi (30 x 15mm Ground plane)

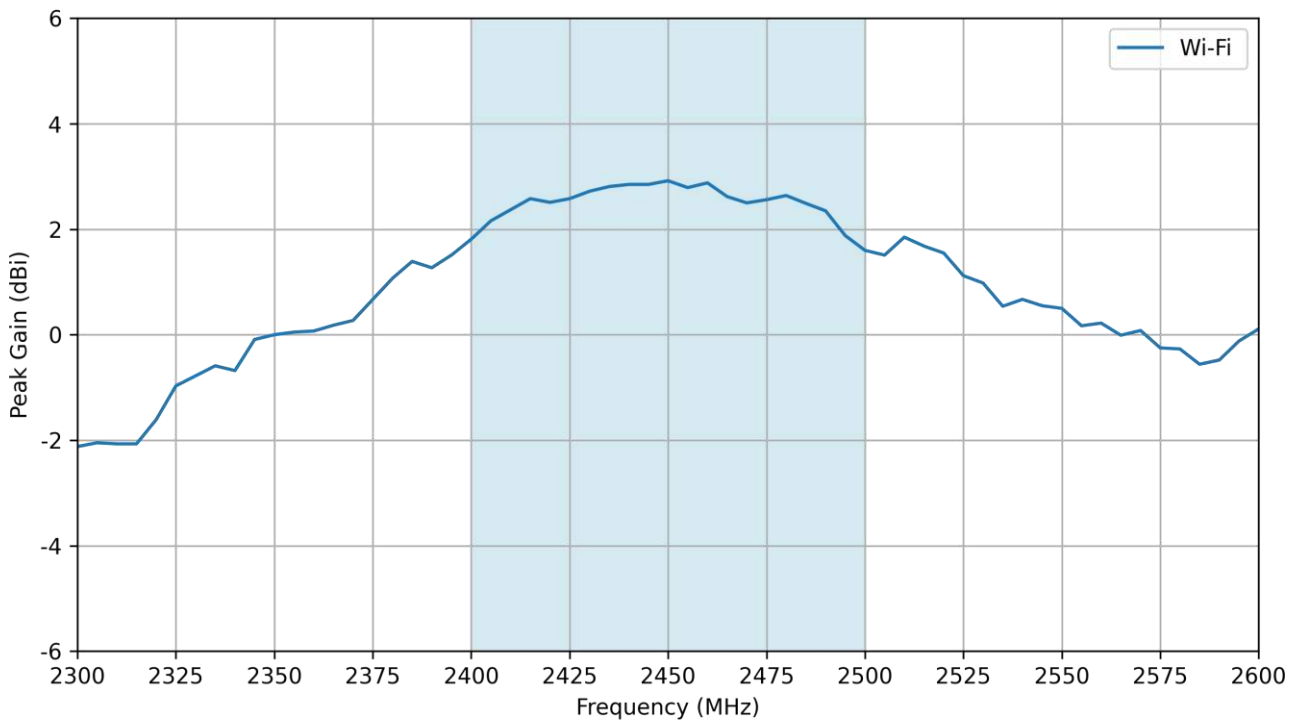

9.9 Matching Circuit (30x15mm Ground plane)

Matching component (C2) in parallel & (C3) in series with the GWLA.05 are required for the antenna to have optimal performance on the evaluation board, located across of the ground plane and feeds in the space specified in the above images. Additional matching components may be necessary for your device, so we recommend incorporating extra component footprints, forming a “pi” network, between the cellular module and the edge of the ground plane.

Designator	Type	Value	Manufacturer	Manufacturer Part Number
L1	Inductor	6.8nH	TDK	MLK1005S6N8DT000
C1	Capacitor	0.7pF	Yageo	CC0402CRNPO9BNR70
C2	Capacitor	1.5pF	Murata	GRM1555C1H1R5CA01D
C3	Capacitor	1.8pF	Murata	GRM1555C1H1R8CA01D

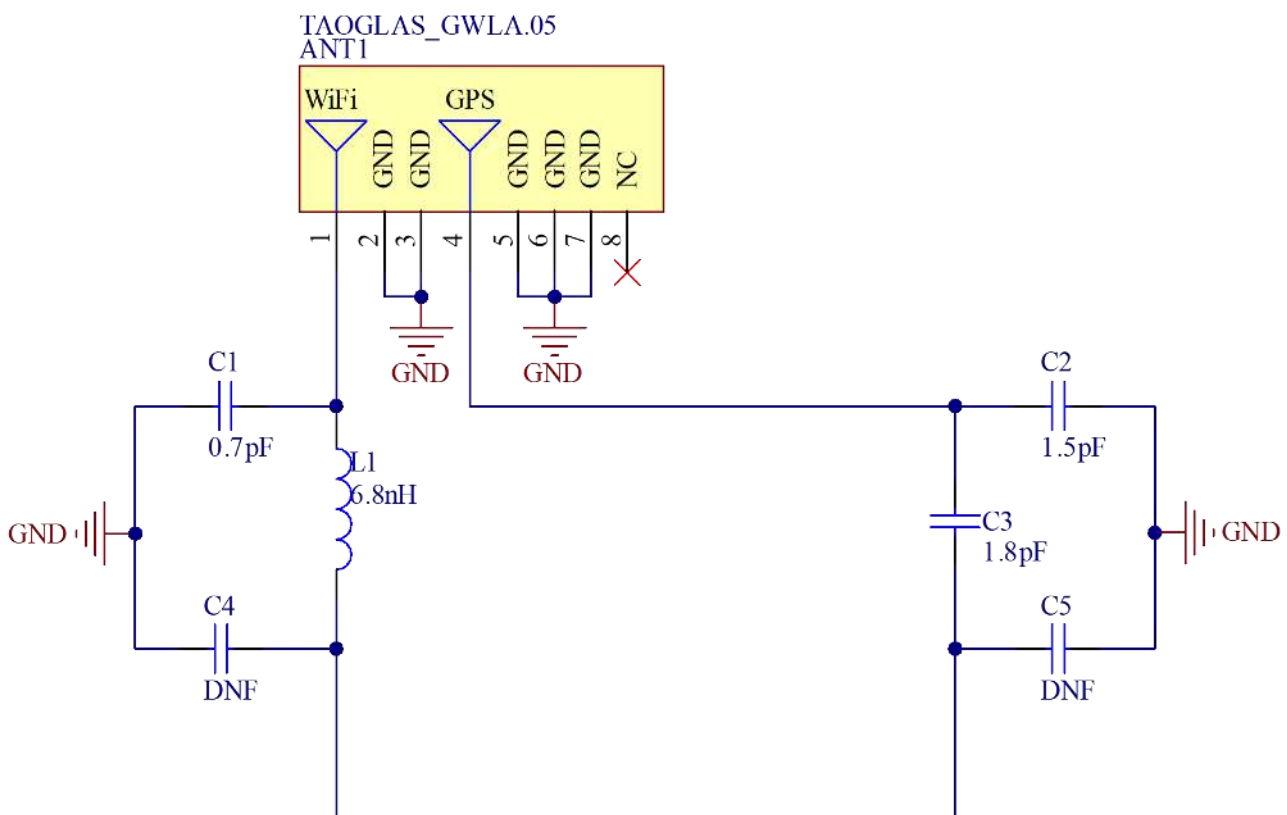

9.10 2D & 3D Radiation Patterns at 1575.42MHz (30x15mm Ground plane)

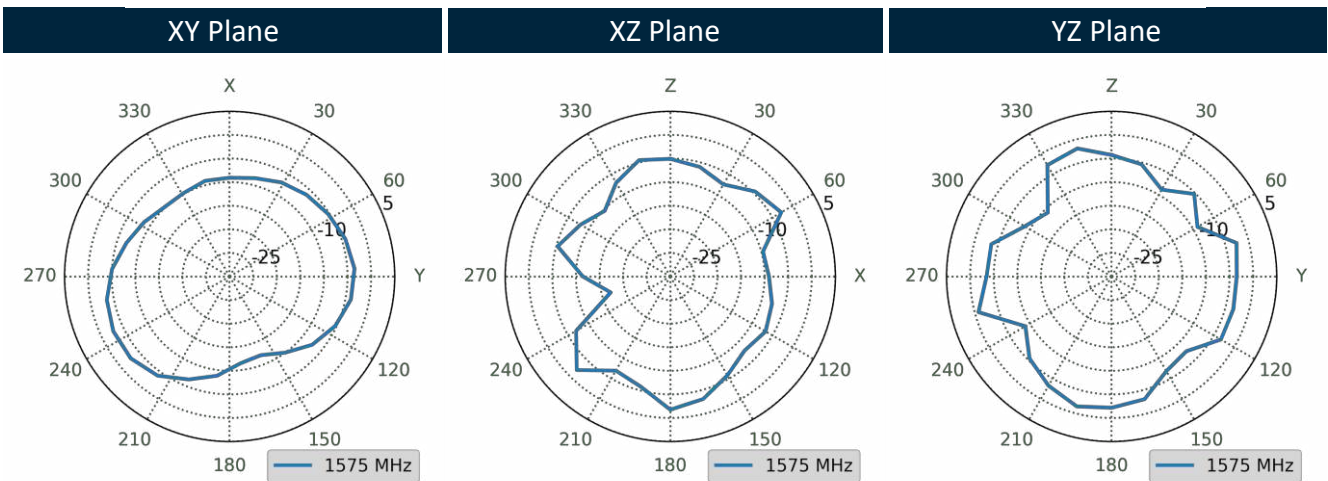
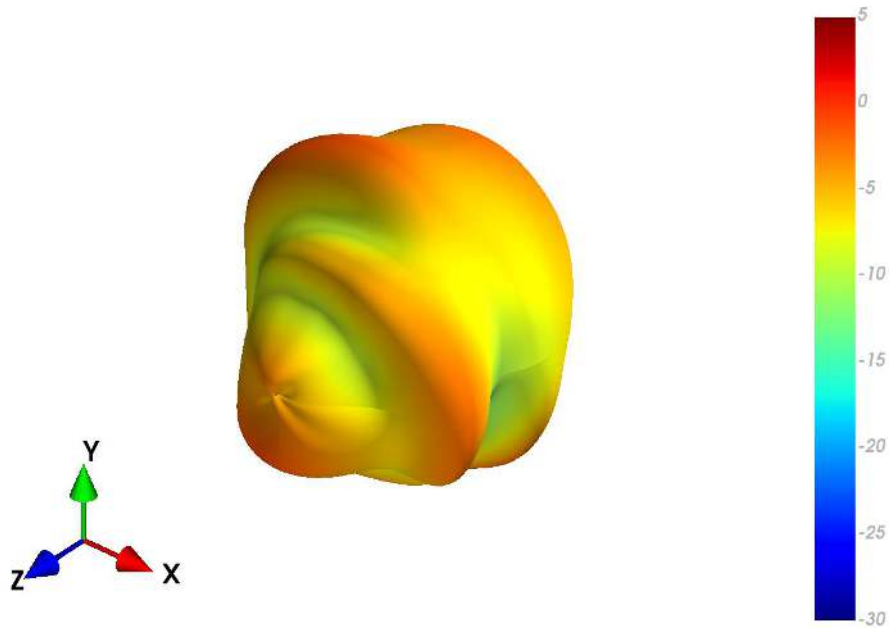

9.11 2D & 3D Radiation Patterns at 2450MHz (30x15mm Ground plane)

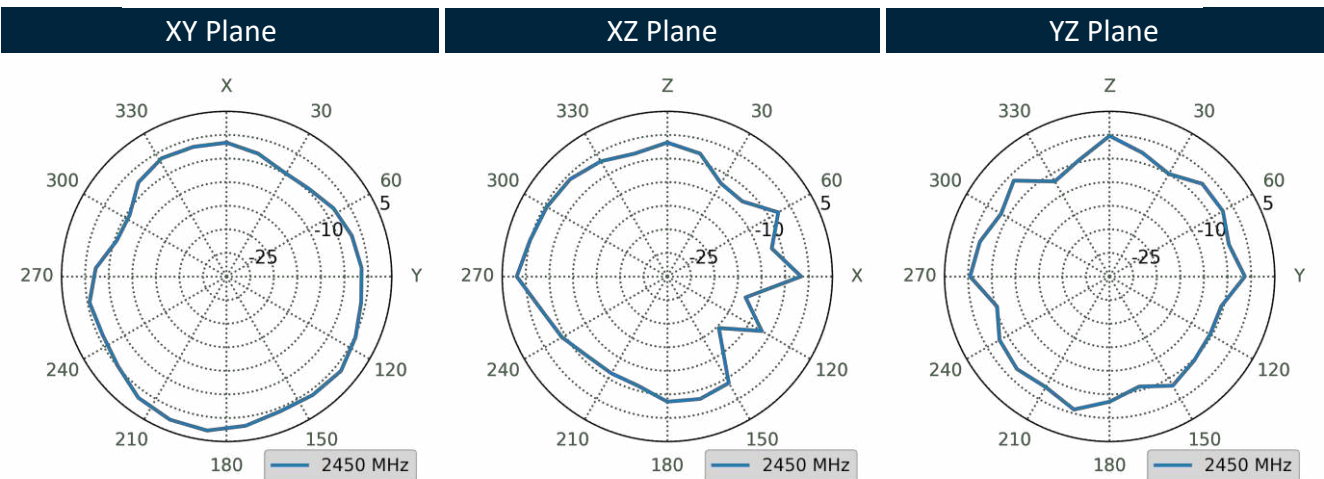
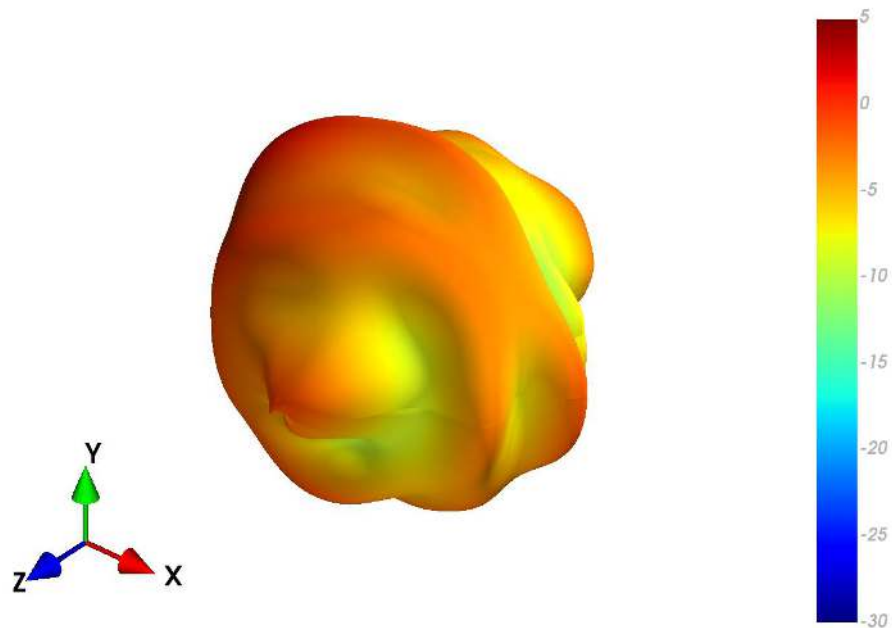

Changelog for the datasheet

SPE-19-8-003 – GWLA.05.A

Revision: C (Current Version)

Date:	2023-01-30
Changes:	Updated antenna integration guide.
Changes Made by:	Gary West

Previous Revisions

Revision: B

Date:	2022-11-08
Changes:	Added Antenna integration guide & Mechanical footprint drawing.
Changes Made by:	Gary West

Revision: A (Original First Release)

Date:	2019-01-22
Notes:	Initial Release
Author:	Technical Writer

