

PA FAMILY SERIES/PA•PAF•PAL CONNECTOR

Wire-to-board (Crimp style/IDC) / Wire-to-wire (Crimp style/IDC)

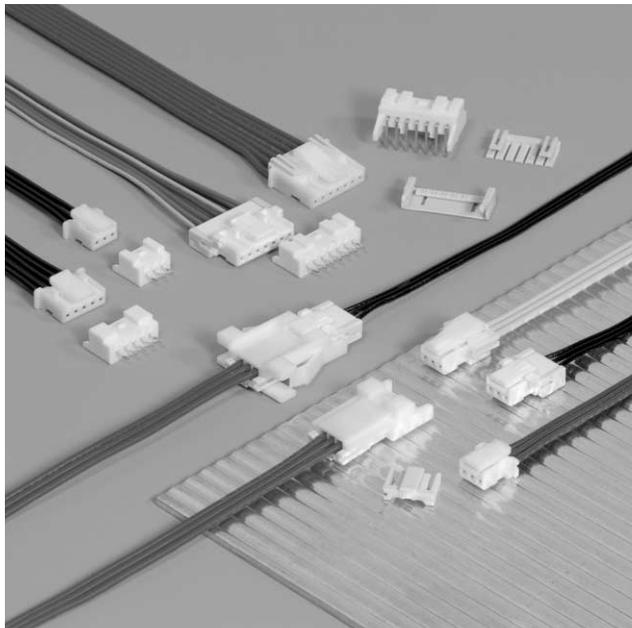

Based upon wire-to-board crimp style PA connectors, the PA series family of connector have been expanded to meet the requirement of complex wire harness of 2.0mm (.079") pitch connectors with secure locking mechanism thanks to the additional line up of wire-to-board IDC style PAF connectors and wire-to-wire crimp style PAL connectors.

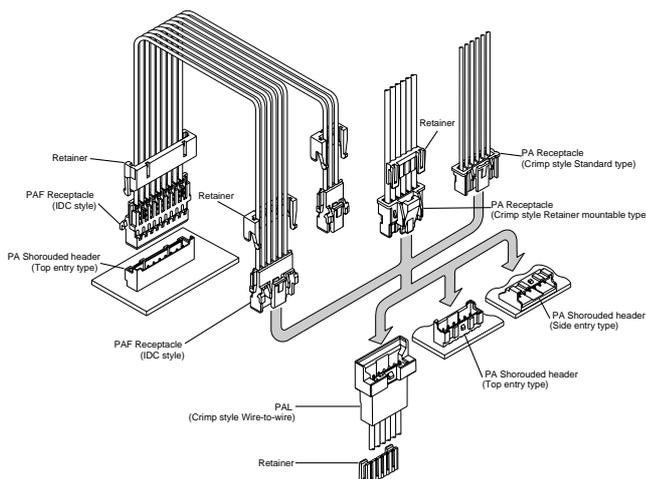

- * Contact JST if Lead-Free product is required.
- * Refer to "General Instruction and Notice when using Terminals and Connectors" at the end of this catalog.
- * Contact JST for details.

Standards

Recognized E60389

Certified LR20812

Features

• Secure locking device

The housing has a locking device to prevent accidental disconnection because of routing of wires or of vibration, and also reverse and different circuit numbers mating.

• Interchangeable between crimp and IDC socket

Both crimp and IDC sockets use the same headers and wire-to-wire mating halves.

• Secondary retainers

Secondary retainers enhance safety in case of partial insertion or accidental release of the contact.

• Harness variation

PAL, wire-to-wire crimp style connector, increases wire harness variation.

PA connector (Standard type, Retainer mountable type)

• Highly reliable contact

The box contact supplies stable contact performance even under conditions of vibration, distortion, low voltage or low current.

• Insertion guide mechanism

Header has housing insertion guides for easy and secure insertion.

• Flanged press pin

Top entry type header has flanged press pins, preventing accidental removal of the pins that might result from the distorted unmating especially in the case of small No. of circuits.

PAF connector

• The industry's first secure lock IDC connectors

By separating ID section and secure lock section, the industry's first secure lock specification has been achieved for IDC that was said to be impossible. Our fully automatic IDC machines, BCD-M5BP (for simple harness) and CAM-M12B, SAD-M12E (for multi-harness), can be applied for harness making.

• Metallic strain relief

Metallic strain relief on the contact securely grips wire insulation that can avoid direct stress of vibration or impact. The same grip strength as insulation barrel of crimp style contact could be achieved.

• Retainer with four locking points

The new four locking points design ensures wire retention force of every direction that is almost superior to contact retention force of crimp style connectors. It also completely covers exposed terminated ID contact.

PAL connector

• The industry's first wire to wire 2.0mm (.079") pitch retainer mountable type connector.

• Either with or without panel lock can be selected according to application.

PA FAMILY SERIES /PA•PAF•PAL CONNECTOR

List of combinations

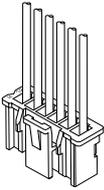
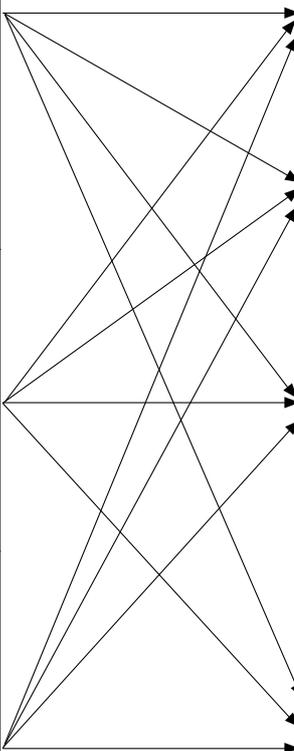
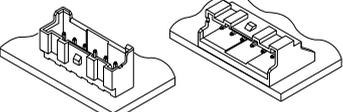
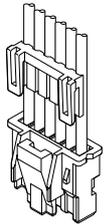
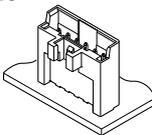
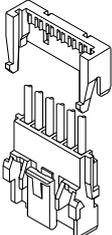
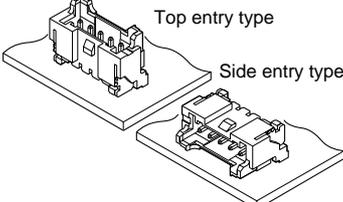
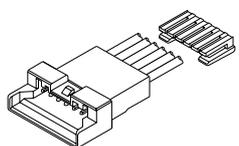
<p>Crimp style Standard type</p> 	<p><u>Contact</u> SPHD-001T-P0.5 SPHD-002T-P0.5</p> <p><u>Housing</u> PAP-()V-S</p>		<p><u>Shrouded header</u> B()B-PASK B()B-PASK-1 S()B-PASK-2</p>	<p>Top entry type Side entry type</p> 
<p>Crimp style Retainer mountable type</p> 	<p><u>Contact</u> SPA-001T-P0.5</p> <p><u>Housing</u> PARP-()V</p> <p><u>Retainer</u> PMS-()V-S</p>		<p><u>Shrouded header</u> BH()B-PASK BH()B-PASK-1</p>	<p>High box type</p> 
<p>Insulation displacement type</p> 	<p><u>Receptacle</u> ()PAF-6S</p> <p><u>Retainer</u> PAFS-()V-S</p>		<p><u>Shrouded header</u> BM()B-PASS BM()B-PASS-1 SM()B-PASS SM()B-PASS-1</p>	<p>SMT type</p> <p>Top entry type Side entry type</p> 
			<p><u>Contact</u> SPAL-001T-P0.5 SPAL-002T-P0.5</p> <p><u>Receptacle housing</u> PALR-()V(F)</p> <p><u>Retainer</u> PMS-()V-S</p>	<p>Wire to wire Connectors</p> 

Specifications

PA Connector (Standard type)

- Current rating: 3A AC, DC (AWG#22)
- Voltage rating: 250V AC, DC
- Temperature range: -25°C to +85°C
(including temperature rise in applying electrical current)
- Contact resistance: Initial value/10m Ω max.
After environmental testing/20m Ω max.
- Insulation resistance: 1,000M Ω min.
- Withstanding voltage: 800V AC/minute
- Applicable wire: AWG #28 to #22
- Applicable PC board thickness: 1.6mm(.063")

PA Connector (Retainer mountable type)

- Current rating: 3A AC, DC (AWG#22)
- Voltage rating: 100V AC, DC
- Temperature range: -25°C to +85°C
(including temperature rise in applying electrical current)
- Contact resistance: Initial value/15m Ω max.
After environmental testing/25m Ω max.
- Insulation resistance: 1,000M Ω min.
- Withstanding voltage: 800V AC/minute
- Applicable wire: AWG #28 to #22

PAF Connector

- Current rating: 1.0A AC, DC (AWG#26)
- Voltage rating: 100V AC, DC
- Temperature range: -25°C to +85°C
(including temperature rise in applying electrical current)
- Contact resistance: Initial value/15m Ω max.
After environmental testing/25m Ω max.
- Insulation resistance: 1,000M Ω min.
- Withstanding voltage: 800V AC/minute
- Applicable wire: UL1061(Contact JST for details regarding other UL wires.)
AWG #26
Conductor/7 strands, tin-coated annealed copper
Insulation O.D./0.9 to 1.0mm(.035" to .039")

PAL Connector

- Current rating: 3A AC, DC (AWG#22)
- Voltage rating: 100V AC, DC
- Temperature range: -25°C to +85°C
(including temperature rise in applying electrical current)
- Contact resistance: Initial value/15m Ω max.
After environmental testing/25m Ω max.
- Insulation resistance: 1,000M Ω min.
- Withstanding voltage: 800V AC/minute
- Applicable wire: AWG #28 to #22
- Applicable panel thickness : 0.5 to 2.0mm(.020" to .079")

PA FAMILY SERIES /PA CONNECTOR (Crimp style Standard type)

Contact

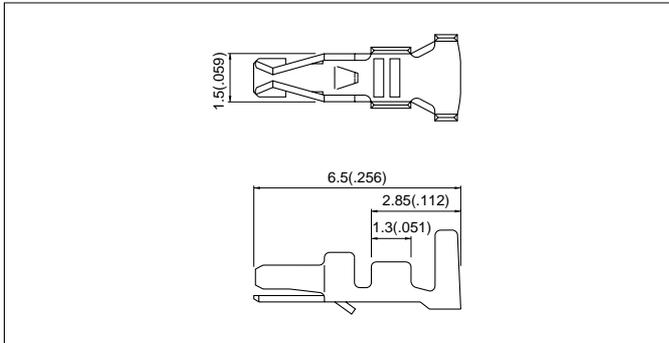

Model No.	Applicable wire			Q'ty / reel
	mm ²	AWG #	Insulation O.D. mm(in.)	
SPHD-001T-P0.5	0.13 to 0.33	26 to 22	1.0 to 1.5(.039 to .059)	8,000
SPHD-002T-P0.5	0.08 to 0.21	28 to 24	0.9 to 1.5(.035 to .059)	

Material and Finish

Phosphor bronze, tin-plated

Housing

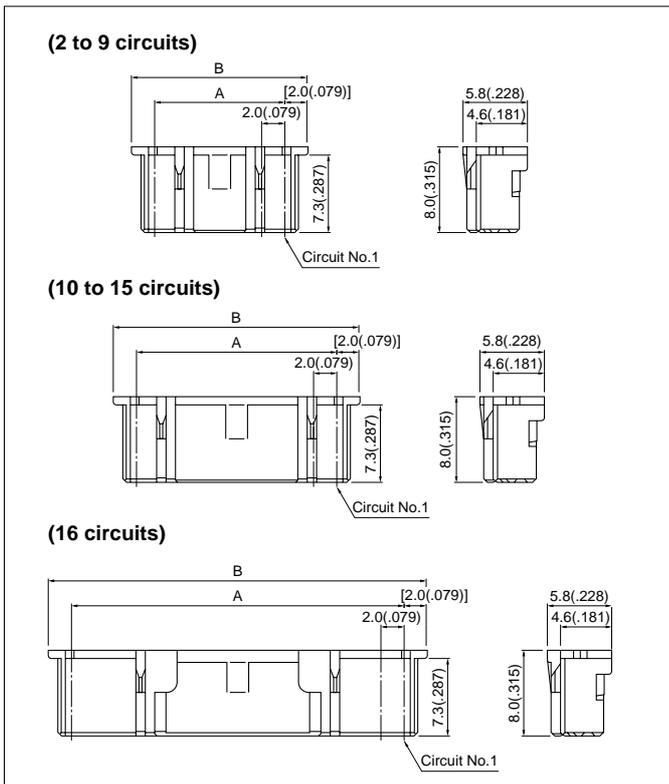

Circuits	Model No.	Dimensions mm(in.)		Q'ty / bag
		A	B	
2	PAP-02V-S	2.0(.079)	6.0(.236)	5,000
3	PAP-03V-S	4.0(.157)	8.0(.315)	5,000
4	PAP-04V-S	6.0(.236)	10.0(.394)	5,000
5	PAP-05V-S	8.0(.315)	12.0(.472)	5,000
6	PAP-06V-S	10.0(.394)	14.0(.551)	1,000
7	PAP-07V-S	12.0(.472)	16.0(.630)	1,000
8	PAP-08V-S	14.0(.551)	18.0(.709)	1,000
9	PAP-09V-S	16.0(.630)	20.0(.787)	1,000
10	PAP-10V-S	18.0(.709)	22.0(.866)	1,000
11	PAP-11V-S	20.0(.787)	24.0(.945)	1,000
12	PAP-12V-S	22.0(.866)	26.0(1.024)	1,000
13	PAP-13V-S	24.0(.945)	28.0(1.102)	1,000
14	PAP-14V-S	26.0(1.024)	30.0(1.181)	1,000
15	PAP-15V-S	28.0(1.102)	32.0(1.260)	1,000
16	PAP-16V-S	30.0(1.181)	34.0(1.339)	1,000

Material

Nylon 66, UL94V-0, natural (white)

<For reference> As the color identification, the following alphabet shall be put in the underlined part.
For availability, delivery and minimum order quantity, contact JST.

ex. **PAP-02V-S**

S...natural (white)

K...black R...red E...blue M...green O...orange N...brown

P...purple PK...pink Y...yellow L...lemon yellow FY...vivid yellow

LE...light blue H...gray TR...tomato red

PA FAMILY SERIES /PA CONNECTOR (Crimp style Standard type)

Through-hole type shrouded header

Top entry type

(2 to 9 circuits)

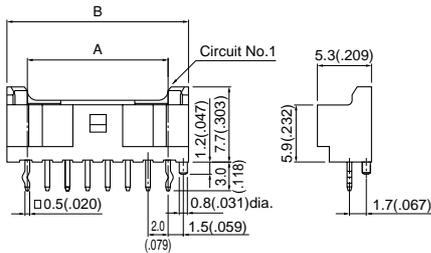

(10 to 15 circuits)

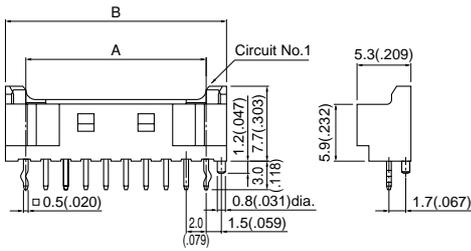

(16 circuits)

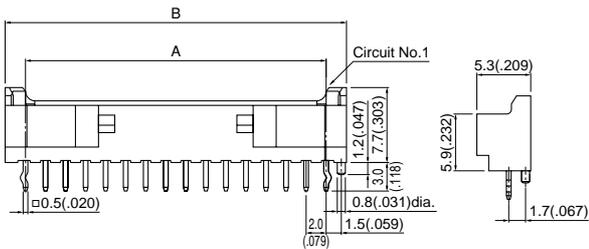

Circuits	Model No.		Dimensions mm(in.)		Q'ty / box
	Without a boss	With a boss	A	B	
2 (Note1)	B02B-PAFYK-A	B02B-PAFYK-1A	2.0(.079)	6.0(.236)	1,000
2	B02B-PASK	B02B-PASK-1	2.0(.079)	6.0(.236)	1,000
3	B03B-PASK	B03B-PASK-1	4.0(.157)	8.0(.315)	1,000
4	B04B-PASK	B04B-PASK-1	6.0(.236)	10.0(.394)	1,000
5	B05B-PASK	B05B-PASK-1	8.0(.315)	12.0(.472)	500
6	B06B-PASK	B06B-PASK-1	10.0(.394)	14.0(.551)	500
7	B07B-PASK	B07B-PASK-1	12.0(.472)	16.0(.630)	500
8	B08B-PASK	B08B-PASK-1	14.0(.551)	18.0(.709)	500
9	B09B-PASK	B09B-PASK-1	16.0(.630)	20.0(.787)	500
10	B10B-PASK	B10B-PASK-1	18.0(.709)	22.0(.866)	500
11	B11B-PASK	B11B-PASK-1	20.0(.787)	24.0(.945)	250
12	B12B-PASK	B12B-PASK-1	22.0(.866)	26.0(1.024)	250
13	B13B-PASK	B13B-PASK-1	24.0(.945)	28.0(1.102)	250
14	B14B-PASK	B14B-PASK-1	26.0(1.024)	30.0(1.181)	250
15	B15B-PASK	B15B-PASK-1	28.0(1.102)	32.0(1.260)	250
16	B16B-PASK	B16B-PASK-1	30.0(1.181)	34.0(1.339)	250

Material and Finish

Post: Copper alloy, copper-undercoated, tin/lead-plated
 Wafer: Glass-filled PBT, UL94V-0, natural (white)
 (Note1) Nylon 66, UL94V-0, vivid yellow

<For reference> As the color identification, the following alphabet shall be put in the underlined part. For availability, delivery and minimum order quantity, contact JST.

ex. **B02B-PASK**
 S...natural (white)
 K...black R...red E...blue M...green O...orange N...brown
 P...purple PK...pink Y...yellow L...lemon yellow FY...vivid yellow
 LE...light blue H...gray TR...tomato red

PA FAMILY SERIES /PA CONNECTOR (Crimp style Standard type)

Through-hole type shrouded header

Side entry type

(2 to 9 circuits)

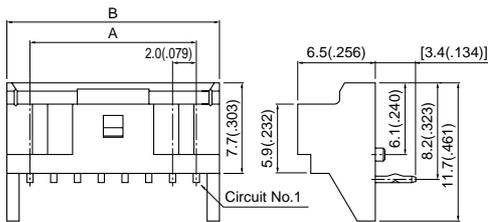

(10 to 15 circuits)

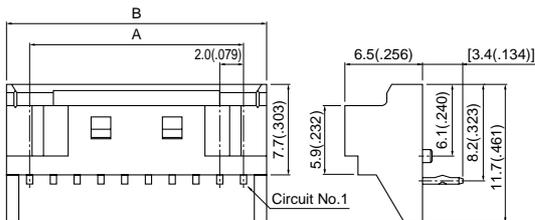

(16 circuits)

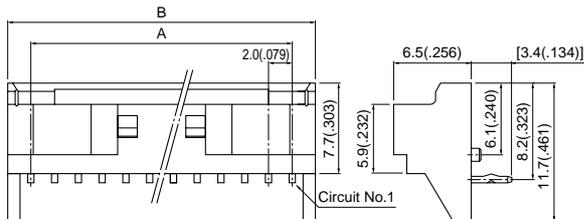

Circuits	Model No.	Dimensions mm(in.)		Qty / box
		A	B	
2	S02B-PASK-2	2.0(.079)	6.0(.236)	1,000
3	S03B-PASK-2	4.0(.157)	8.0(.315)	1,000
4	S04B-PASK-2	6.0(.236)	10.0(.394)	500
5	S05B-PASK-2	8.0(.315)	12.0(.472)	500
6	S06B-PASK-2	10.0(.394)	14.0(.551)	500
7	S07B-PASK-2	12.0(.472)	16.0(.630)	250
8	S08B-PASK-2	14.0(.551)	18.0(.709)	250
9	S09B-PASK-2	16.0(.630)	20.0(.787)	250
10	S10B-PASK-2	18.0(.709)	22.0(.866)	250
11	S11B-PASK-2	20.0(.787)	24.0(.945)	250
12	S12B-PASK-2	22.0(.866)	26.0(1.024)	250
13	S13B-PASK-2	24.0(.945)	28.0(1.102)	250
14	S14B-PASK-2	26.0(1.024)	30.0(1.181)	200
15	S15B-PASK-2	28.0(1.102)	32.0(1.260)	200
16	S16B-PASK-2	30.0(1.181)	34.0(1.339)	200

Material and Finish

Post: Copper alloy, copper-undercoated, tin/lead-plated
Wafer: Glass-filled PBT, UL94V-0, natural (white)

<For reference> As the color identification, the following alphabet shall be put in the underlined part. For availability, delivery and minimum order quantity, contact JST.

ex. **S03B-PASK-2**

S...natural (white)

K...black R...red E...blue M...green O...orange N...brown

P...purple PK...pink Y...yellow L...lemon yellow LE...light blue

H...gray TR...tomato red

PA FAMILY SERIES / PA CONNECTOR (Crimp style Standard type)

SMT type shrouded header

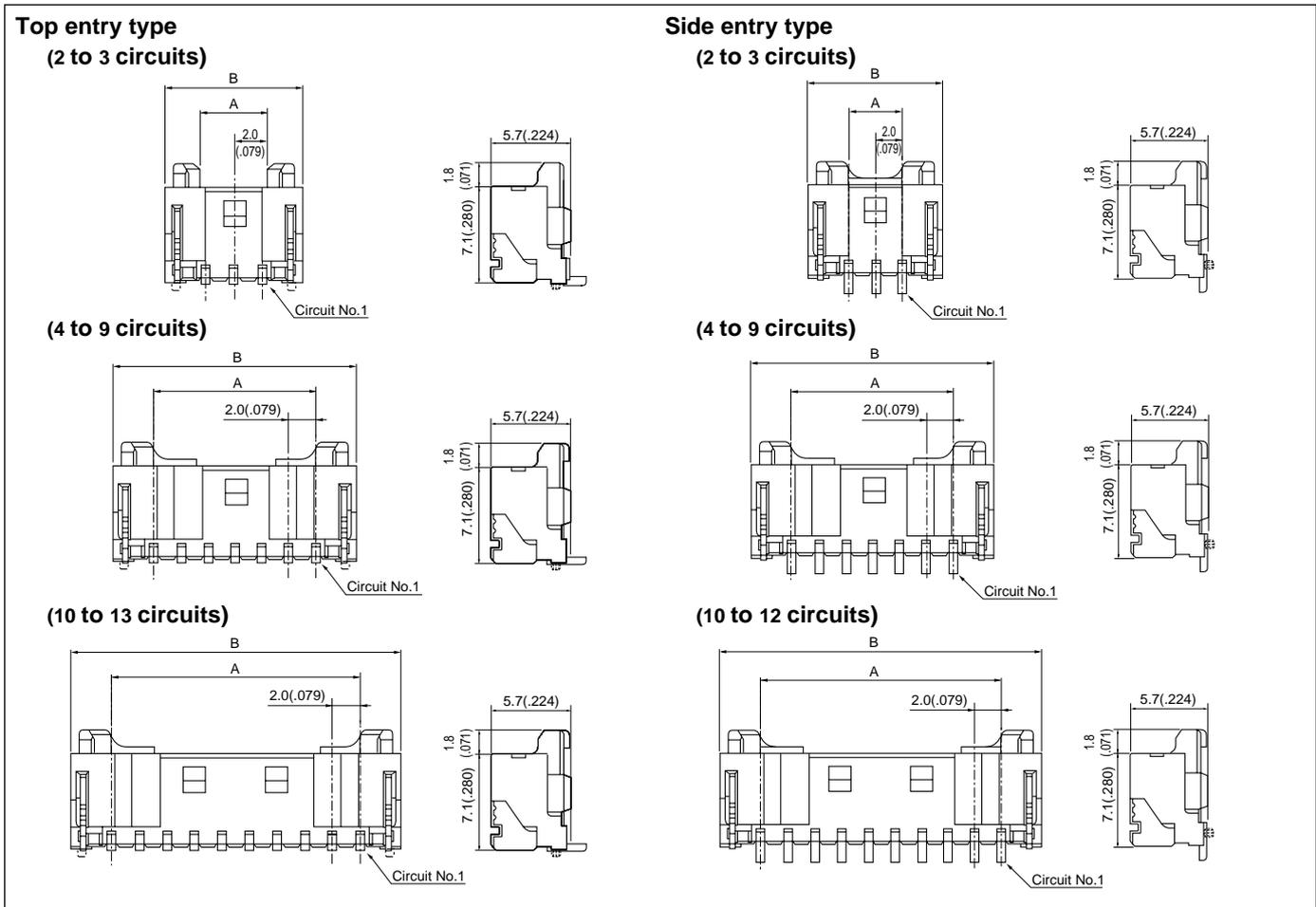

Top entry type

Circuits	Model No.		Dimensions mm(in.)		Q'ty / reel
	Without a boss	With a boss	A	B	
2	BM02B-PASS-*	BM02B-PASS-1-*	2.0(.079)	8.0(.315)	500
3	BM03B-PASS-*	BM03B-PASS-1-*	4.0(.157)	10.0(.394)	500
4	BM04B-PASS-*	BM04B-PASS-1-*	6.0(.236)	12.0(.472)	500
5	BM05B-PASS-*	BM05B-PASS-1-*	8.0(.315)	14.0(.551)	500
6	BM06B-PASS-*	BM06B-PASS-1-*	10.0(.394)	16.0(.630)	500
7	BM07B-PASS-*	BM07B-PASS-1-*	12.0(.472)	18.0(.709)	500
8	BM08B-PASS-*	BM08B-PASS-1-*	14.0(.551)	20.0(.787)	500
9	BM09B-PASS-*	BM09B-PASS-1-*	16.0(.630)	22.0(.866)	500
10	BM10B-PASS-*	BM10B-PASS-1-*	18.0(.709)	24.0(.945)	500
11	BM11B-PASS-*	BM11B-PASS-1-*	20.0(.787)	26.0(1.024)	500
12	BM12B-PASS-*	BM12B-PASS-1-*	22.0(.866)	28.0(1.102)	500
13	BM13B-PASS-*	BM13B-PASS-1-*	24.0(.945)	30.0(1.181)	500

Material and Finish

Post: Brass, copper-undercoated, tin-plated
 Wafer: Polyamide resin, UL94V-0, natural (ivory)
 Solder tab: Brass, copper-undercoated, tin-plated

Note:

- (*) : TF...taping product
 TFT...taping product with suction tape.
- BM13B-PASS-*(*) and BM13B-PASS-1-*(*) are not UL/CSA approved.

Side entry type

Circuits	Model No.		Dimensions mm(in.)		Q'ty / reel
	Without a boss	With a boss	A	B	
2	SM02B-PASS-*	SM02B-PASS-1-*	2.0(.079)	8.0(.315)	1,000
3	SM03B-PASS-*	SM03B-PASS-1-*	4.0(.157)	10.0(.394)	1,000
4	SM04B-PASS-*	SM04B-PASS-1-*	6.0(.236)	12.0(.472)	1,000
5	SM05B-PASS-*	SM05B-PASS-1-*	8.0(.315)	14.0(.551)	1,000
6	SM06B-PASS-*	SM06B-PASS-1-*	10.0(.394)	16.0(.630)	1,000
7	SM07B-PASS-*	SM07B-PASS-1-*	12.0(.472)	18.0(.709)	1,000
8	SM08B-PASS-*	SM08B-PASS-1-*	14.0(.551)	20.0(.787)	1,000
9	SM09B-PASS-*	SM09B-PASS-1-*	16.0(.630)	22.0(.866)	1,000
10	SM10B-PASS-*	SM10B-PASS-1-*	18.0(.709)	24.0(.945)	1,000
11	SM11B-PASS-*	SM11B-PASS-1-*	20.0(.787)	26.0(1.024)	1,000
12	SM12B-PASS-*	SM12B-PASS-1-*	22.0(.866)	28.0(1.102)	1,000

Material and Finish

Post: Brass, copper-undercoated, tin-plated
 Wafer: Polyamide resin, UL94V-0, natural (ivory)
 Solder tab: Brass, copper-undercoated, tin-plated

Note:

- (*) : TB...taping product
 TBT...taping product with suction tape.

PA FAMILY SERIES /PA CONNECTOR (Crimp style Standard type)

Taping specifications

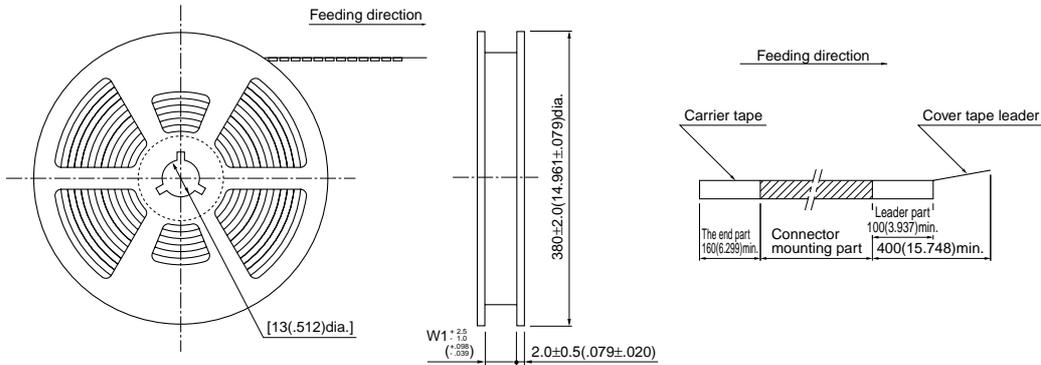

Top entry type (2 to 5 circuits)

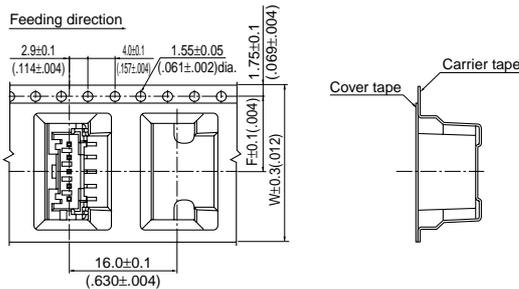

(6 to 13 circuits)

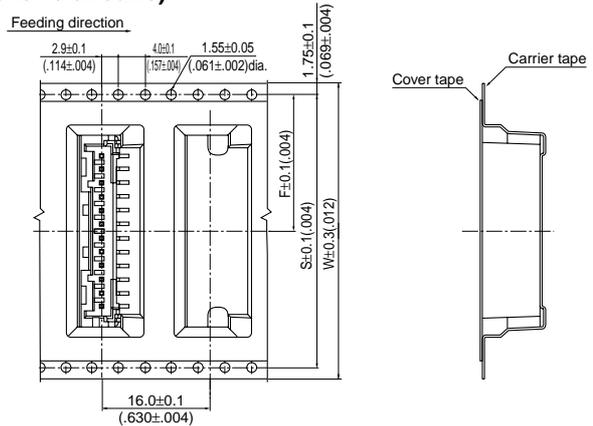

Side entry type (2 to 5 circuits)

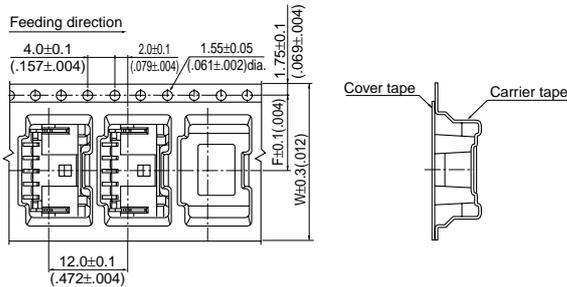

(6 to 12 circuits)

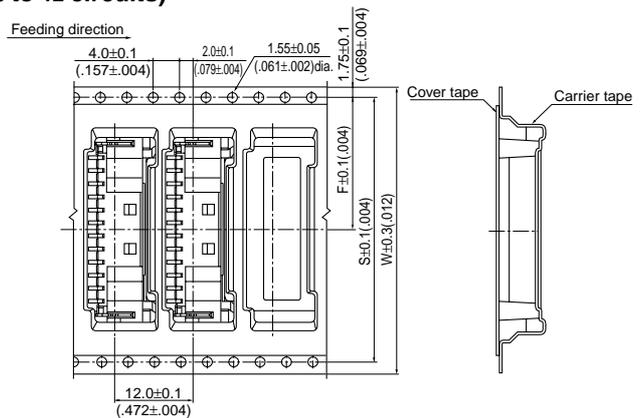

Circuits	Taping dimensions mm(in.)			Reel dimensions mm(in.)		Q'ty / reel	
	F	S	W	W ₁	Top entry type	Side entry type	
2 to 5	11.5(.453)	-	24.0(.945)	25.5(1.004)	500	1,000	
6, 7	14.2(.559)	28.4(1.118)	32.0(1.260)	33.5(1.319)	500	1,000	
8 to 13	20.2(.795)	40.4(1.591)	44.0(1.732)	45.5(1.791)	500	1,000	

Note:

- Specifications conform to JIS C 0806. The tape width, connector loading recess square hole dimensions, etc. are determined by the number of circuits and external shape of the connector to be loaded.
- Specifications are subject to change without prior notice.

PA FAMILY SERIES / PA CONNECTOR (Crimp style Standard type)

Shrouded header <High box type>

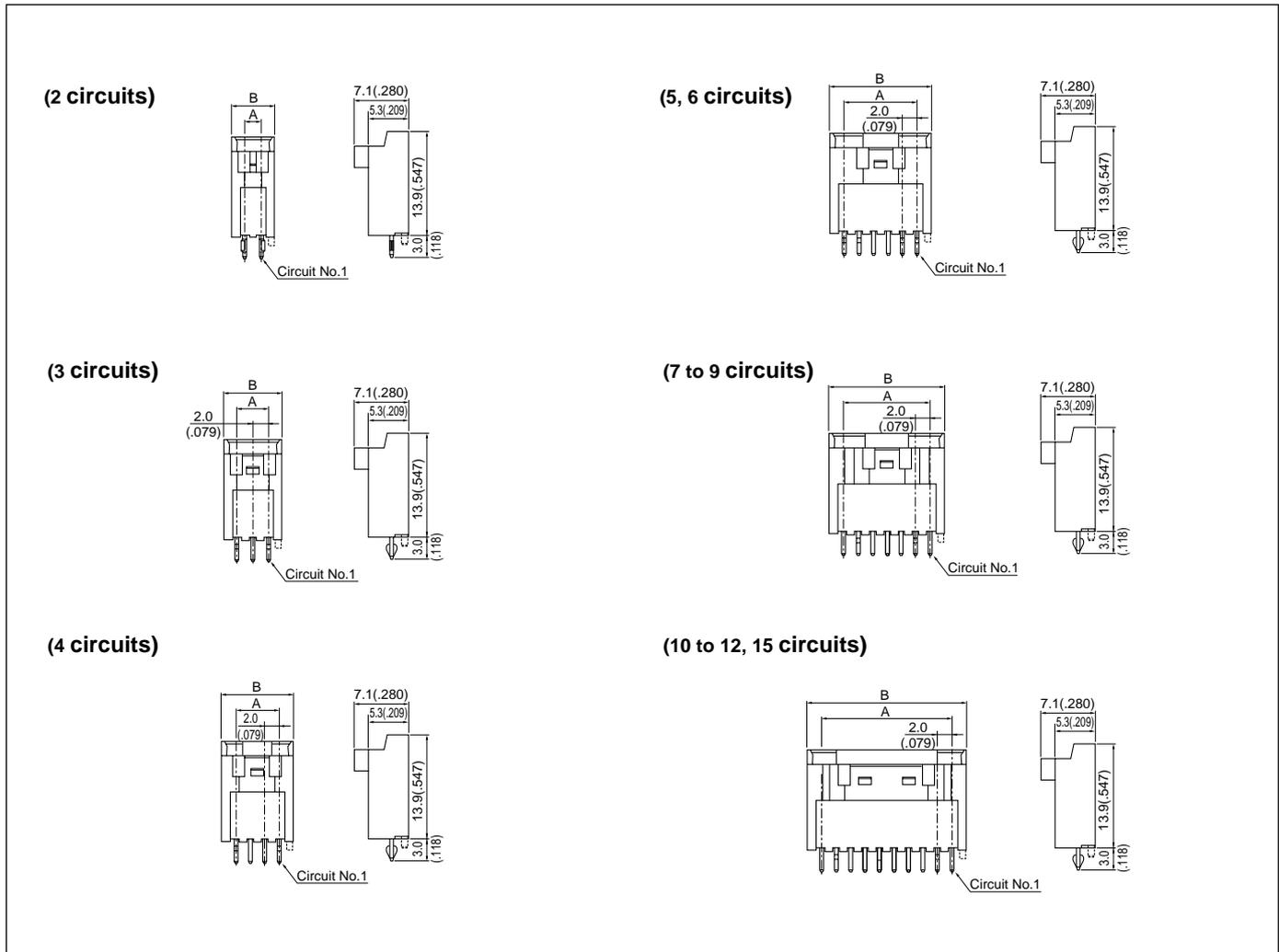

Circuits	Model No.		Dimensions mm(in.)		Qty / box
	Without a boss	With a boss	A	B	
2	BH02B-PASK	BH02B-PASK-1	2.0 (.079)	6.0 (.236)	900
3	BH03B-PASK	BH03B-PASK-1	4.0 (.157)	8.0 (.315)	675
4	BH04B-PASK	BH04B-PASK-1	6.0 (.236)	10.0 (.394)	550
5	BH05B-PASK	BH05B-PASK-1	8.0 (.315)	12.0 (.472)	450
6	BH06B-PASK	BH06B-PASK-1	10.0 (.394)	14.0 (.551)	375
7	BH07B-PASK	BH07B-PASK-1	12.0 (.472)	16.0 (.630)	325
8	BH08B-PASK	BH08B-PASK-1	14.0 (.551)	18.0 (.709)	300
9	BH09B-PASK	BH09B-PASK-1	16.0 (.630)	20.0 (.787)	275
10	BH10B-PASK	BH10B-PASK-1	18.0 (.709)	22.0 (.866)	250
11	BH11B-PASK	BH11B-PASK-1	20.0 (.787)	24.0 (.945)	225
12	BH12B-PASK	BH12B-PASK-1	22.0 (.866)	26.0 (1.024)	200
15	BH15B-PASK	BH15B-PASK-1	28.0 (1.102)	32.0 (1.260)	150

Material and Finish

Post: Copper alloy, copper-undercoated, tin/lead-plated
 Wafer: Glass-filled PBT, UL94V-0, natural (white)

PA FAMILY SERIES /PA CONNECTOR (Crimp style Retainer mountable type)

Contact

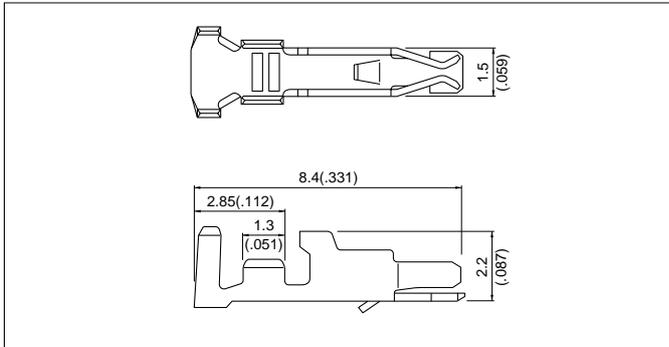

Model No.	Applicable wire			Q'ty / reel
	mm ²	AWG #	Insulation O.D. mm(in.)	
SPA-001T-P0.5	0.13 to 0.33	26 to 22	0.9 to 1.5(.035 to .059)	10,000

Material and Finish

Phosphor bronze, tin-plated

Housing

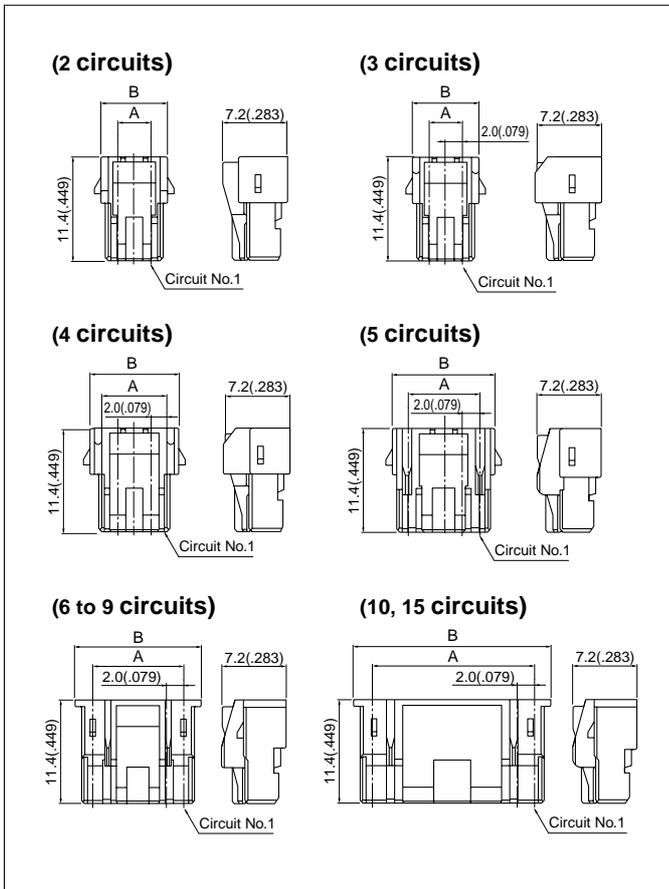

Circuits	Model No.	Dimensions mm(in.)		Q'ty / bag
		A	B	
2	PARP-02V	2.0(.079)	5.4(.213)	1,000
3	PARP-03V	4.0(.157)	7.4(.291)	1,000
4	PARP-04V	6.0(.236)	9.4(.370)	1,000
5	PARP-05V	8.0(.315)	11.4(.449)	1,000
6	PARP-06V	10.0(.394)	14.0(.551)	1,000
7	PARP-07V	12.0(.472)	16.0(.630)	1,000
8	PARP-08V	14.0(.551)	18.0(.709)	1,000
9	PARP-09V	16.0(.630)	20.0(.787)	1,000
10	PARP-10V	18.0(.709)	22.0(.866)	1,000
15	PARP-15V	28.0(1.102)	32.0(1.260)	500

Material

Nylon 66, UL94V-0, natural (white)

Note: PARP-15V is not CSA approved.

<For reference> As the color identification, the following alphabet shall be put in the underlined part.

For availability, delivery and minimum order quantity, contact JST.

ex. **PARP-02V-oo**

(blank)...natural (white)

R...red E...blue Y...yellow M...green

PA FAMILY SERIES /PA CONNECTOR (Crimp style Retainer mountable type)

Retainer

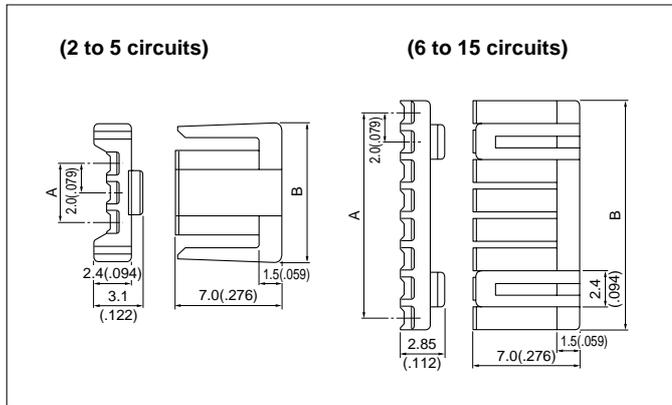

Circuits	Model No.	Dimensions mm(in.)		Q'ty / bag
		A	B	
2	PMS-02V-S	2.0(.079)	7.3(.287)	1,000
3	PMS-03V-S	4.0(.157)	9.3(.366)	1,000
4	PMS-04V-S	6.0(.236)	11.3(.445)	1,000
5	PMS-05V-S	8.0(.315)	13.3(.524)	1,000
6	PMS-06V-S	10.0(.394)	11.55(.455)	1,000
7	PMS-07V-S	12.0(.472)	13.55(.533)	1,000
8	PMS-08V-S	14.0(.551)	15.55(.612)	1,000
9	PMS-09V-S	16.0(.630)	17.55(.691)	1,000
10	PMS-10V-S	18.0(.709)	19.55(.770)	1,000
15	PMS-15V-S	28.0(1.102)	29.55(1.163)	1,000

Material

Glass-filled nylon 66, UL94V-0, natural (ivory)

Note: PMS-09V-S, PMS-10V-S and PMS-15V-S are not CSA approved.

PA FAMILY SERIES /PAF CONNECTOR (Insulation displacement type)

Receptacle

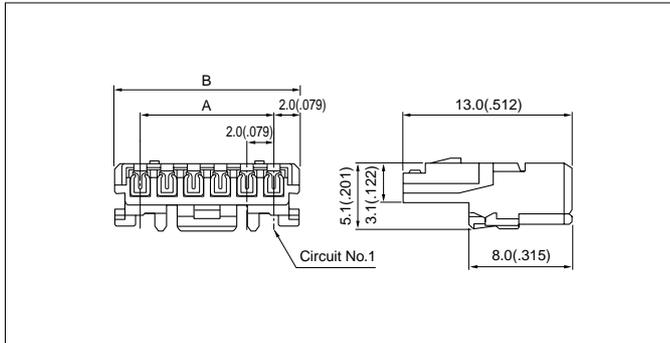

Circuits	Model No.	Dimensions mm(in.)		Q'ty / box
		A	B	
2	02PAF-6S	2.0(.079)	6.0(.236)	1,000
3	03PAF-6S	4.0(.157)	8.0(.315)	1,000
4	04PAF-6S	6.0(.236)	10.0(.394)	500
5	05PAF-6S	8.0(.315)	12.0(.472)	500
6	06PAF-6S	10.0(.394)	14.0(.551)	500
7	07PAF-6S	12.0(.472)	16.0(.630)	500
8	08PAF-6S	14.0(.551)	18.0(.709)	250
9	09PAF-6S	16.0(.630)	20.0(.787)	250
10	10PAF-6S	18.0(.709)	22.0(.866)	250
11	11PAF-6S	20.0(.787)	24.0(.945)	250
12	12PAF-6S	22.0(.866)	26.0(1.024)	250
13	13PAF-6S	24.0(.945)	28.0(1.102)	250
14	14PAF-6S	26.0(1.024)	30.0(1.181)	250
15	15PAF-6S	28.0(1.102)	32.0(1.260)	250

Material and Finish

Contact: Phosphor bronze, tin-plated
Housing: Nylon 66, UL94V-0, natural (white)

<For reference> As the color identification, the following alphabet shall be put in the underlined part. For availability, delivery and minimum order quantity, contact JST.

ex. **02PAF-6S**

S...natural (white)

R...red E...blue M...green Y...yellow

Retainer

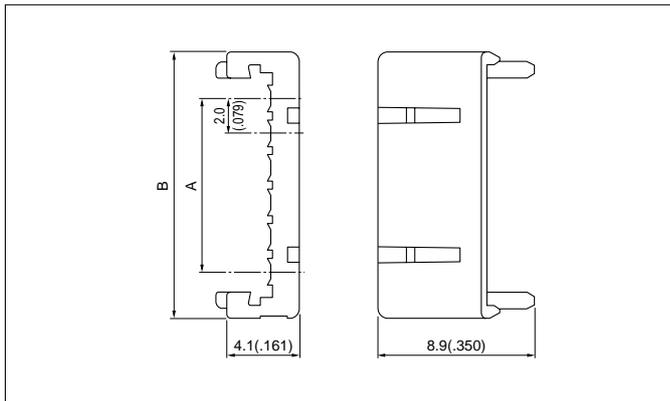

Circuits	Model No.	Dimensions mm(in.)		Q'ty / bag
		A	B	
2	PAFS-02V-S	2.0(.079)	7.4(.291)	1,000
3	PAFS-03V-S	4.0(.157)	9.4(.370)	1,000
4	PAFS-04V-S	6.0(.236)	11.4(.449)	1,000
5	PAFS-05V-S	8.0(.315)	13.4(.528)	1,000
6	PAFS-06V-S	10.0(.394)	15.4(.606)	1,000
7	PAFS-07V-S	12.0(.472)	17.4(.685)	1,000
8	PAFS-08V-S	14.0(.551)	19.4(.764)	1,000
9	PAFS-09V-S	16.0(.630)	21.4(.843)	1,000
10	PAFS-10V-S	18.0(.709)	23.4(.921)	1,000
11	PAFS-11V-S	20.0(.787)	25.4(1.000)	1,000
12	PAFS-12V-S	22.0(.866)	27.4(1.079)	1,000
13	PAFS-13V-S	24.0(.945)	29.4(1.157)	1,000
14	PAFS-14V-S	26.0(1.024)	31.4(1.236)	1,000
15	PAFS-15V-S	28.0(1.102)	33.4(1.315)	1,000

Material

Glass-filled nylon 66, UL94V-0, natural (ivory)

Note: PAFS-09V-S, PAFS-10V-S, PAFS-11V-S, PAFS-12V-S, PAFS-13V-S, PAFS-14V-S and PAFS-15V-S are not UL/CSA approved.

PA FAMILY SERIES /PAL CONNECTOR (Wire-to-wire type)

Contact

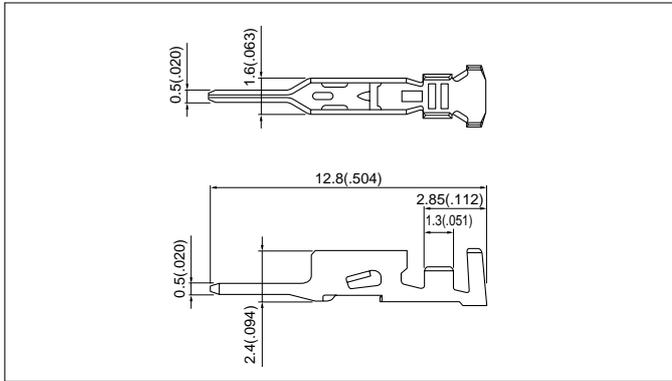

Model No.	Applicable wire			Q'ty / reel
	mm ²	AWG #	Insulation O.D. mm(in.)	
SPAL-001T-P0.5	0.13 to 0.33	26 to 22	1.0 to 1.5(.039 to .059)	10,000
SPAL-002T-P0.5	0.08 to 0.21	28 to 24	0.9 to 1.5(.035 to .059)	

Material and Finish

Phosphor bronze, tin-plated

Housing

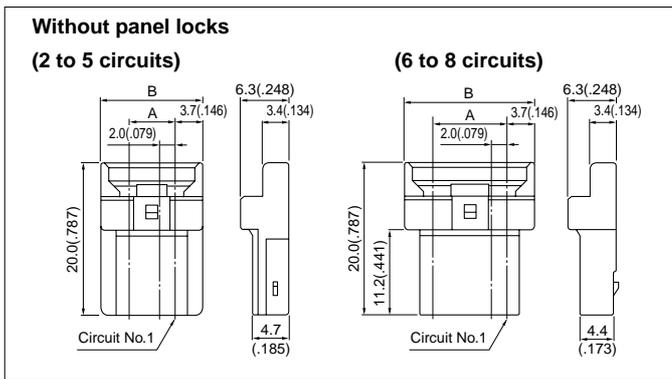

Circuits	Model No.	Dimensions mm(in.)		Q'ty / bag
		A	B	
2	PALR-02VF	2.0 (.079)	9.4 (.370)	1,000
3	PALR-03VF	4.0 (.157)	11.4 (.449)	1,000
4	PALR-04VF	6.0 (.236)	13.4 (.528)	1,000
5	PALR-05VF	8.0 (.315)	15.4 (.606)	1,000
6	PALR-06VF	10.0 (.394)	17.4 (.685)	1,000
7	PALR-07VF	12.0 (.472)	19.4 (.764)	1,000
8	PALR-08VF	14.0 (.551)	21.4 (.843)	1,000

Material

Nylon 66, UL94V-0, natural (white)

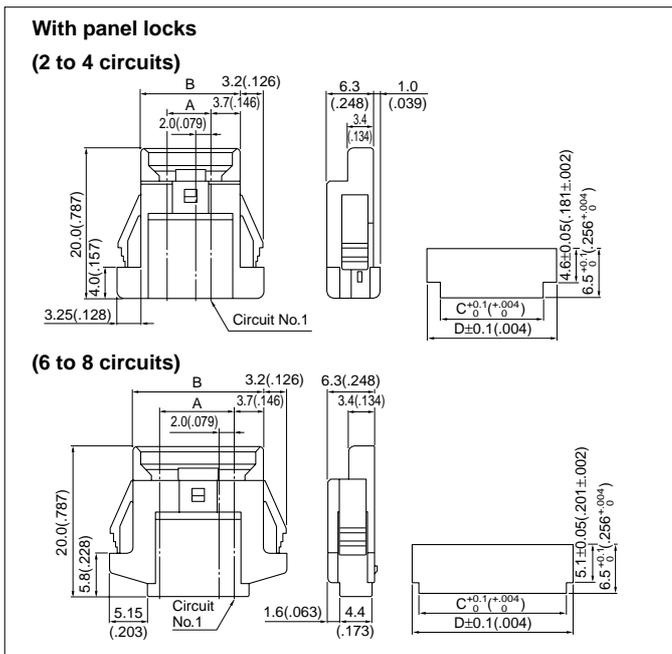

Circuits	Model No.	Dimensions mm(in.)				Q'ty / bag
		A	B	C	D	
2	PALR-02V	2.0(.079)	9.4(.370)	9.8(.386)	13.4(.528)	1,000
3	PALR-03V	4.0(.157)	11.4(.449)	11.8(.465)	15.4(.606)	1,000
4	PALR-04V	6.0(.236)	13.4(.528)	13.8(.543)	17.4(.685)	1,000
6	PALR-06V	10.0(.394)	17.4(.685)	19.8(.780)	21.4(.843)	1,000
7	PALR-07V	12.0(.472)	19.4(.764)	21.8(.858)	23.4(.921)	1,000
8	PALR-08V	14.0(.551)	21.4(.843)	23.8(.937)	25.4(1.000)	1,000

Material

Nylon 66, UL94V-0, natural (white)

<For reference> As the color identification, the following alphabet shall be put in the underlined part. For availability, delivery and minimum order quantity, contact JST.

ex. **PALR-02V(F)-oo**
 (blank)...natural (white)
 R...red E...blue M...green Y...yellow

Retainer

Retainers are interchangeable with those of the PA crimp style retainer mountable type.

PA FAMILY SERIES /PA•PAF•PAL CONNECTOR

PC board layout (viewed from component side) and Assembly layout

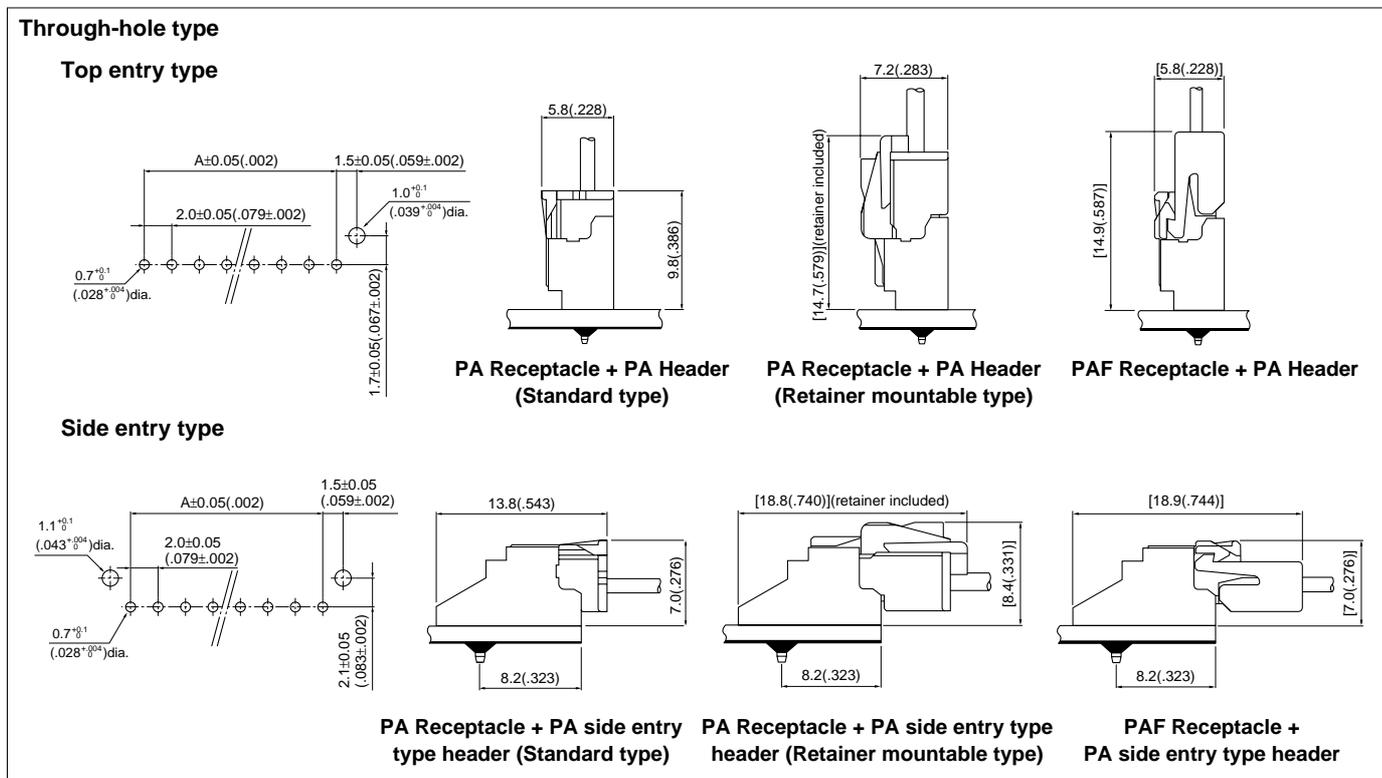

- Note:**
1. Tolerances are non-cumulative: $\pm 0.05\text{mm}$ ($\pm 0.002''$) for all centers.
 2. Hole dimensions differ according to the kind of PC board and piercing method. The dimensions above should serve as a guideline. Contact JST for details.

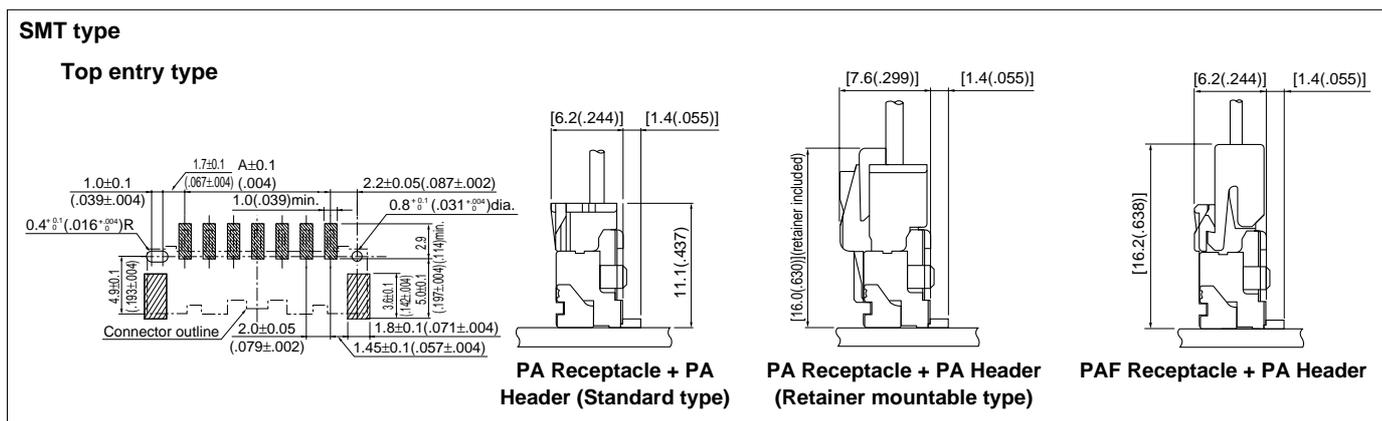

- Note:**
1. Tolerances are non-cumulative: $\pm 0.05\text{mm}$ ($\pm 0.002''$) for all centers.
 2. The dimensions above should serve as a guideline. Contact JST for details.

PA FAMILY SERIES /PA•PAF•PAL CONNECTOR

PC board layout (viewed from component side) and Assembly layout

SMT type

Side entry type

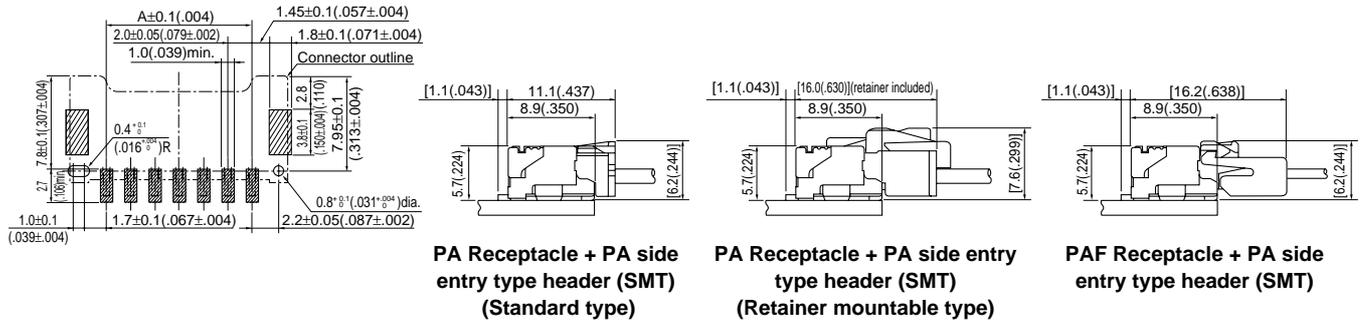

High box type

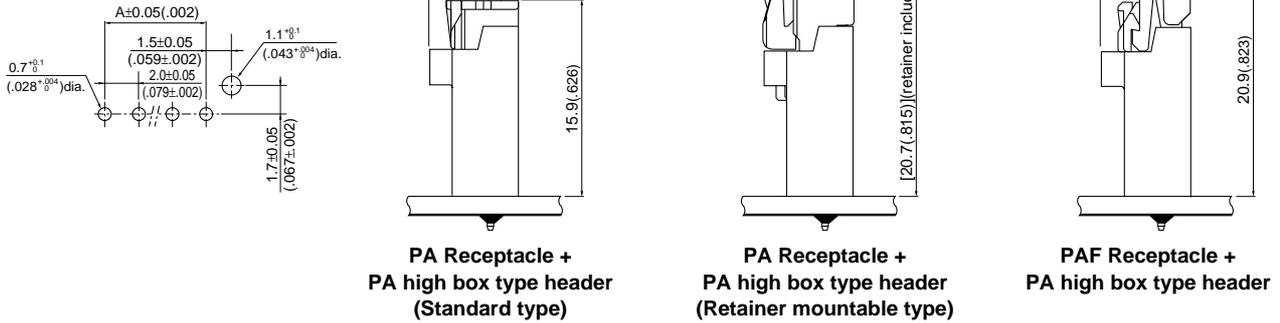

- Note:
1. Tolerances are non-cumulative: $\pm 0.05\text{mm}$ ($\pm .002''$) for all centers.
 2. Hole dimensions differ according to the kind of PC board and piercing method. The dimensions above should serve as a guideline. Contact JST for details.

Assembly layout

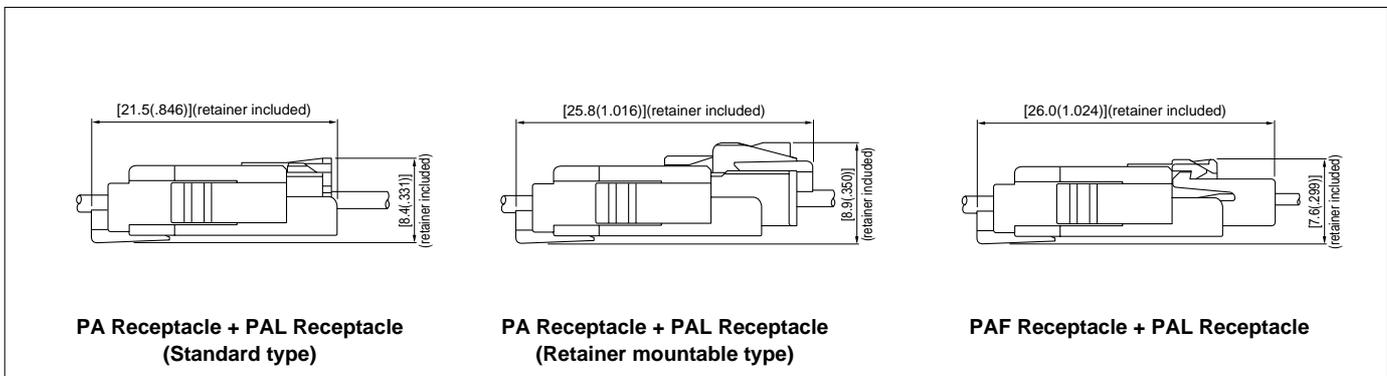

PA FAMILY SERIES /PA•PAF•PAL CONNECTOR

Applicator for the semi-automatic press AP-K2N

Contact	Crimp applicator MKS-L(-10)		Compact crimp applicator MKS-LS-10		Strip-crimp applicator MKS-SC-10
	with safety cover	without safety cover	with safety cover	without safety cover	with safety cover
SPHD-001T-P0.5	APLMK SPHD001-05	APLNC SPHD001-05	APLMKLS SPHD001-05	APLLSNC SPHD001-05	APLSC SPHD001-05
SPHD-002T-P0.5	APLMK SPHD002-05	APLNC SPHD002-05	APLMKLS SPHD002-05	APLLSNC SPHD002-05	APLSC SPHD002-05
SPA-001T-P0.5	APLMK SPA001-05	APLNC SPA001-05	–	–	–
SPAL-001T-P0.5	APLMK SPAL001-05	APLNC SPAL001-05	–	–	–
SPAL-002T-P0.5	APLMK SPAL002-05	APLNC SPAL002-05	–	–	–