



Main

| | |
|----------------------------|---------------------|
| Range of Product | Harmony GTU |
| Product or Component Type | Flat screen |
| Terminal type | Touchscreen display |
| Integrated connection type | USB 2.0 type A |

Complementary

| | |
|---------------------------|----------------------------------|
| Pixel resolution | 800 x 600 |
| Touchscreen resolution | 1024 x 1024 |
| Provided equipment | 1 flash card |
| Function Available | Brightness sensor |
| [Us] rated supply voltage | 12...24 V DC power supply |
| Supply voltage limits | 10.8...28.8 V |
| Power Consumption in W | 15 W |
| Display size | 10.4 inch |
| Aspect ratio | 4:3 |
| Display type | Colour TFT LCD |
| Display Resolution | 800 x 600 pixels SVGA |
| Display colour | 16 million colours |
| Backlight lifespan | 50000 hours |
| Touch panel | Multi touch analogue resistive |
| Type of Installation | Indoor installation |
| Type of cooling | Natural convection |
| Inrush current | 30 A |
| Cut-out dimensions | 259 (+ 1/- 0) x 201 (+ 1/- 0) mm |
| Width | 10.73 in (272.5 mm) |
| Height | 8.44 in (214.5 mm) |
| Depth | 2.64 in (67 mm) |
| Net Weight | 5.95 lb(US) (2.7 kg) |

Environment

| | |
|---------------------------------------|------------------------------------|
| IP degree of protection | Front panel IP66 |
| NEMA degree of protection | NEMA 4X front panel |
| Standards | UL 508 |
| Product Certifications | CE |
| Ambient air temperature for operation | 32...140 °F (0...60 °C) EN 61131-2 |
| Ambient air temperature for storage | -4...140 °F (-20...60 °C) |
| Pollution degree | 2 |
| Relative Humidity | 10...90 % non-condensing |
| Operating altitude | 6561.68 ft (2000 m) |

| | |
|-------------------------------|---|
| Vibration resistance | 3.5 mm constant amplitude 5...9 Hz) EN/IEC 61131-2 |
| Shock resistance | 147 m/s ² EN/IEC 61131-2 |
| Electromagnetic compatibility | Electrostatic discharge immunity testlevel 3 EN/IEC 61000-4-2 |





Ordering and shipping details

| | |
|-----------------------|-------------------------|
| Category | 22567 - MAGELIS HMI GTU |
| Discount Schedule | MC2 |
| GTIN | 3606480841668 |
| Nbr. of units in pkg. | 1 |
| Package weight(Lbs) | 8.82 lb(US) (4 kg) |
| Returnability | No |
| Country of origin | CN |

Packing Units

| | |
|------------------------------|-------------------------|
| Unit Type of Package 1 | PCE |
| Package 1 Height | 7.48 in (19 cm) |
| Package 1 width | 12.99 in (33 cm) |
| Package 1 Length | 14.76 in (37.5 cm) |
| Unit Type of Package 2 | CAR |
| Number of Units in Package 2 | 2 |
| Package 2 Weight | 18.27 lb(US) (8.289 kg) |
| Package 2 Height | 16.93 in (43 cm) |
| Package 2 width | 13.98 in (35.5 cm) |
| Package 2 Length | 17.91 in (45.5 cm) |

Offer Sustainability

| | |
|----------------------------|---|
| Sustainable offer status | Green Premium product |
| California proposition 65 | WARNING: This product can expose you to chemicals including: Lead and lead compounds, which is known to the State of California to cause cancer and birth defects or other reproductive harm. For more information go to www.P65Warnings.ca.gov |
| REACH Regulation |  REACH Declaration |
| REACH free of SVHC | Yes |
| EU RoHS Directive | Pro-active compliance (Product out of EU RoHS legal scope)  EU RoHS Declaration |
| Mercury free | Yes |
| RoHS exemption information |  Yes |
| China RoHS Regulation |  China RoHS Declaration |
| WEEE | The product must be disposed on European Union markets following specific waste collection and never end up in rubbish bins. |

External Dimensions

Display Unit with Box Module

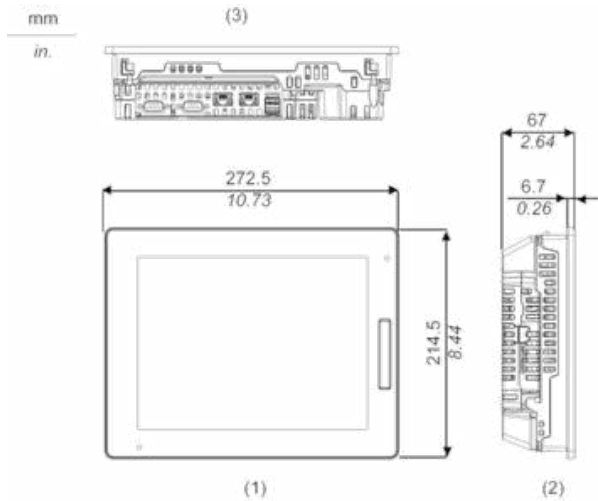

- 1 Front
- 2 Left
- 3 Bottom

Installation with Installation Fasteners and Dimensions with Cables

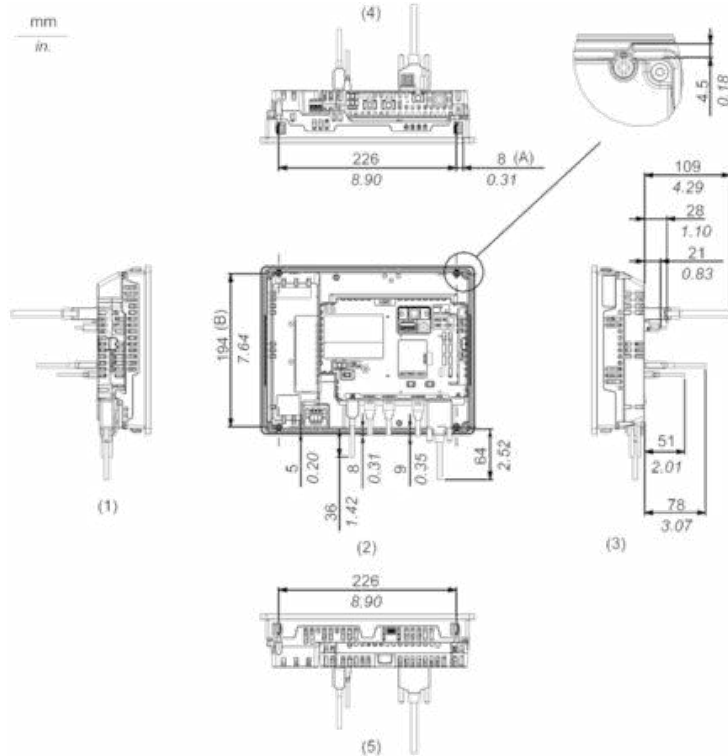

- (A) Rotation area of the fastener
- (B) Pitch of the center of installation fastner screws

- 1 Right
- 2 Front
- 3 Left
- 4 Bottom

Mounting

Panel Cut Dimensions

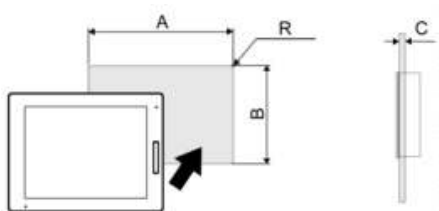

Dimensions in mm

| A | B | C | R |
|-------------|-------------|---------|--------|
| 259 (+1/-0) | 201 (+1/-0) | 1.6...5 | 3 max. |

Dimensions in in.

| A | B | C | R |
|-----------------|-----------------|------------|-----------|
| 10.2 (+0.04/-0) | 7.91 (+0.04/-0) | 0.06...0.2 | 0.12 max. |

Installation Requirements

Mounting Angle

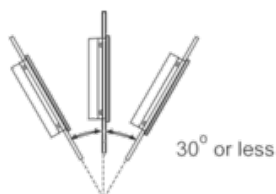

When installing this product in a slanted position with an incline more than 30°, the ambient temperature must not exceed 40 °C (104 °F). You may need to use forced air cooling (fan, A/C) to ensure the ambient operating temperature is 40 °C or less (104 °F or less).

Clearance

