

BTFE 6-3/18 4U - Test terminal strip



1029255

<https://www.phoenixcontact.com/pc/products/1029255>

Please be informed that the data shown in this PDF document is generated from our online catalog. Please find the complete data in the user documentation. Our general terms of use for downloads are valid.



Test terminal strip, nom. voltage: 400 V, nominal current: 24 A, connection method: Ring cable lug, 1 level, Rated cross section: 6 mm², mounting type: Wall mounting, color: gray

Commercial data

Item number	1029255
Packing unit	1 pc
Minimum order quantity	1 pc
Product key	BE6114
Catalog page	Page 650 (C-1-2019)
GTIN	4055626531113
Weight per piece (including packing)	878 g
Weight per piece (excluding packing)	878 g
Customs tariff number	85369010
Country of origin	PL

BTFE 6-3/18 4U - Test terminal strip



1029255

<https://www.phoenixcontact.com/pc/products/1029255>

Technical data

Product properties

Product type	Test terminal strip
--------------	---------------------

Insulation characteristics

Overvoltage category	III
----------------------	-----

Electrical properties

Rated surge voltage	4 kV
Maximum power dissipation for nominal condition	1.02 W
Test surge voltage	5 kV

Connection data

Nominal cross section	4 mm ²
-----------------------	-------------------

1 level

Tightening torque	1 ... 1.3 Nm
Internal cylindrical gage	A5
Connection in acc. with standard	IEC 60947-7-1
Conductor cross section flexible	0.5 mm ² ... 6 mm ²
Conductor cross section, flexible [AWG]	24 ... 10 (converted acc. to IEC)
Nominal current	24 A
Maximum load current	24 A
Nominal voltage	400 V
Nominal cross section	6 mm ²

Cable lug connection DIN 46237:1970-07

Connection in acc. with standard	DIN 46237:1970-07
Cross section	0.5 mm ² ... 2.5 mm ²
Cross section range AWG	(converted acc. to IEC)
Hole diameter	3.7 mm
Width	6.8 mm
Bolt diameter	3.5 mm
Identification color of ring cable lugs : red	1 mm ²
Identification color of ring cable lugs : blue	2.5 mm ²
Cross section	4 mm ² ... 6 mm ²
Additional text	Type RS PRO Order No. 267-3919, vertical crimping
Cross section range AWG	(converted acc. to IEC)
Hole diameter	3.7 mm
Width	7.2 mm
Bolt diameter	3.5 mm

Material specifications

Color	gray
-------	------

BTFE 6-3/18 4U - Test terminal strip



1029255

<https://www.phoenixcontact.com/pc/products/1029255>

Flammability rating according to UL 94	V0
Insulating material group	I
Insulating material	PC
Relative insulation material temperature index (Elec., UL 746 B)	130 °C

Electrical tests

Surge voltage test

Result	Test passed
Result	Test passed

Power-frequency withstand voltage

Test voltage setpoint	2 kV
Result	Test passed

Mechanical properties

Mechanical data

Open side panel	No
-----------------	----

Mechanical tests

Mechanical strength

Result	Test passed
--------	-------------

Attachment on the carrier

Result	Test passed
--------	-------------

Test for conductor damage and slackening

Conductor cross section/weight	2.5 mm ² / 0.7 kg
	2.0 mm ² / 0.7 kg
Result	Test passed

Environmental and real-life conditions

Aging

Temperature cycles	192
Result	Test passed

Needle-flame test

Result	Test passed
--------	-------------

Ambient conditions

Ambient temperature (operation)	-60 °C ... 85 °C (max. short-term operating temperature RTI Elec.)
Ambient temperature (storage/transport)	-25 °C ... 55 °C (for a short time, not exceeding 24 h, -60 °C to +70 °C)
Ambient temperature (assembly)	-5 °C ... 70 °C
Ambient temperature (actuation)	-5 °C ... 70 °C

BTFE 6-3/18 4U - Test terminal strip



1029255

<https://www.phoenixcontact.com/pc/products/1029255>

Permissible humidity (storage/transport)	30 % ... 70 %
--	---------------

Standards and regulations

Connection in acc. with standard	IEC 60947-7-1
----------------------------------	---------------

Mounting

Mounting type	Wall mounting
---------------	---------------

BTFE 6-3/18 4U - Test terminal strip

1029255

<https://www.phoenixcontact.com/pc/products/1029255>



Drawings

Dimensional drawing

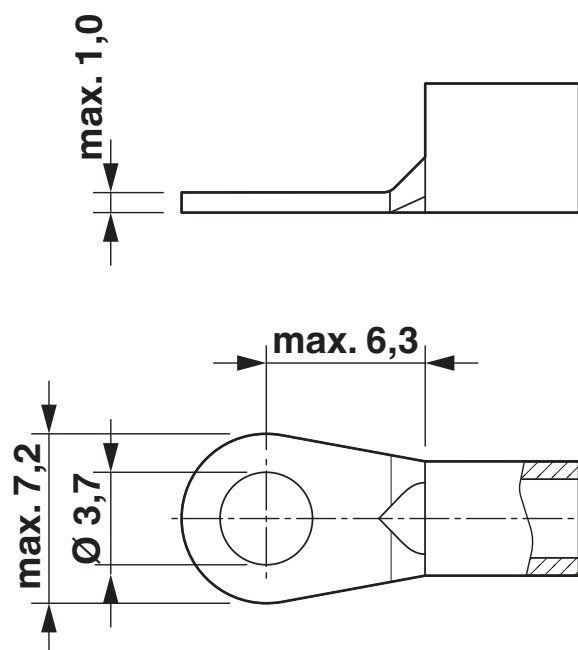

BTFE 6-3/18 4U - Test terminal strip

1029255

<https://www.phoenixcontact.com/pc/products/1029255>



Circuit diagram

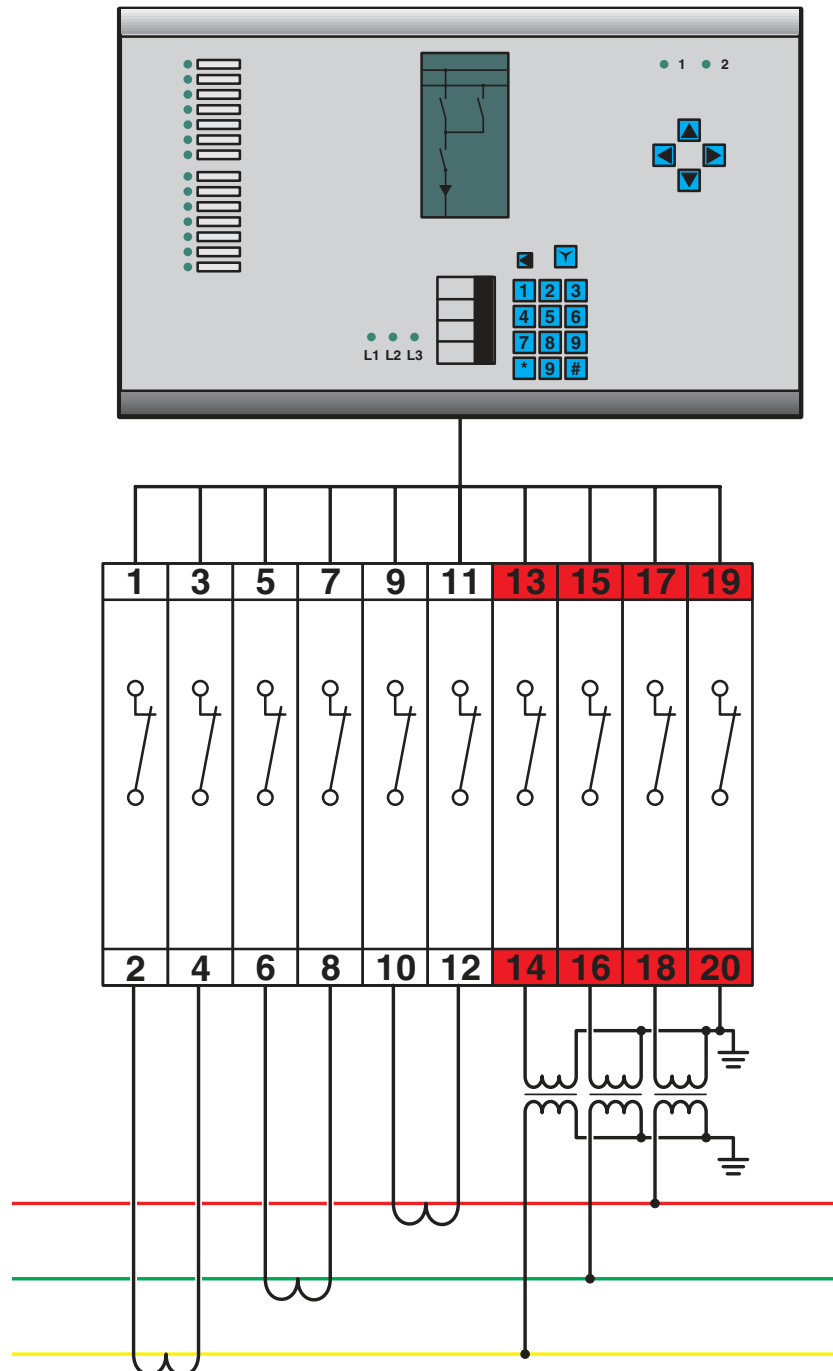

BTFE 6-3/18 4U - Test terminal strip

1029255

<https://www.phoenixcontact.com/pc/products/1029255>

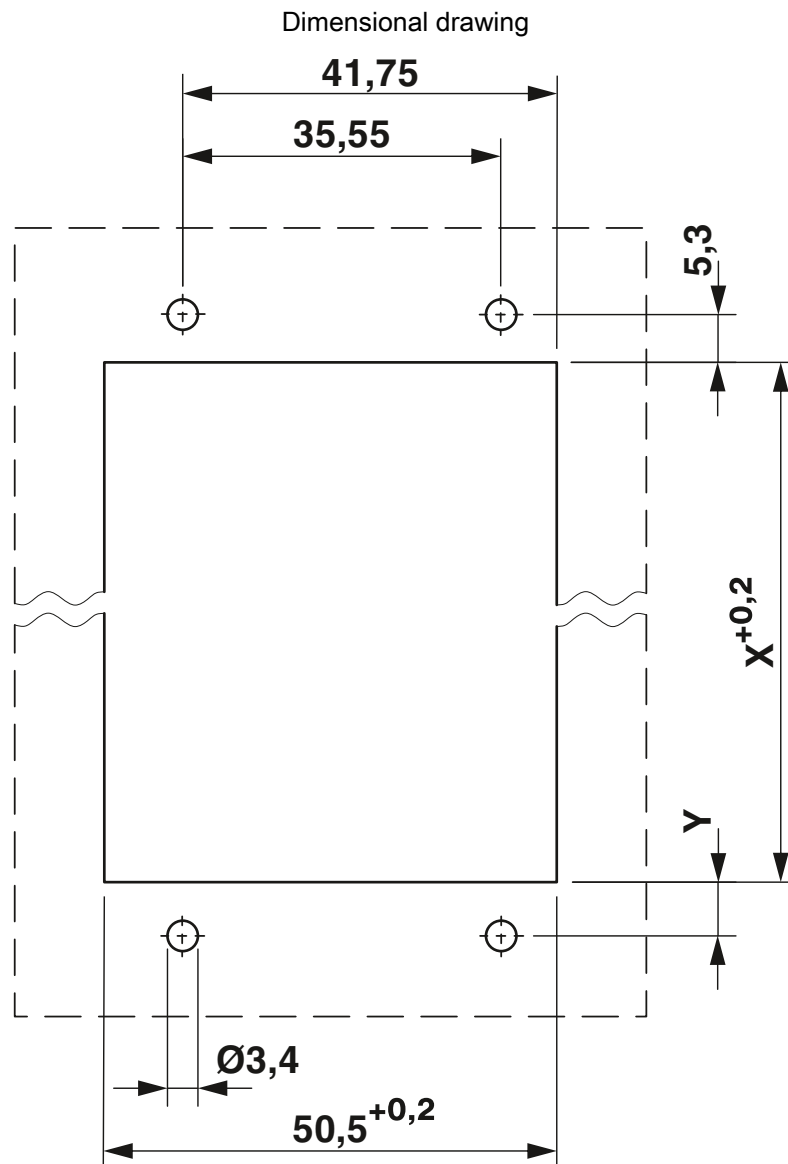

X = 156.6 mm

Y = 6.0 mm

BTFE 6-3/18 4U - Test terminal strip

1029255

<https://www.phoenixcontact.com/pc/products/1029255>



Dimensional drawing

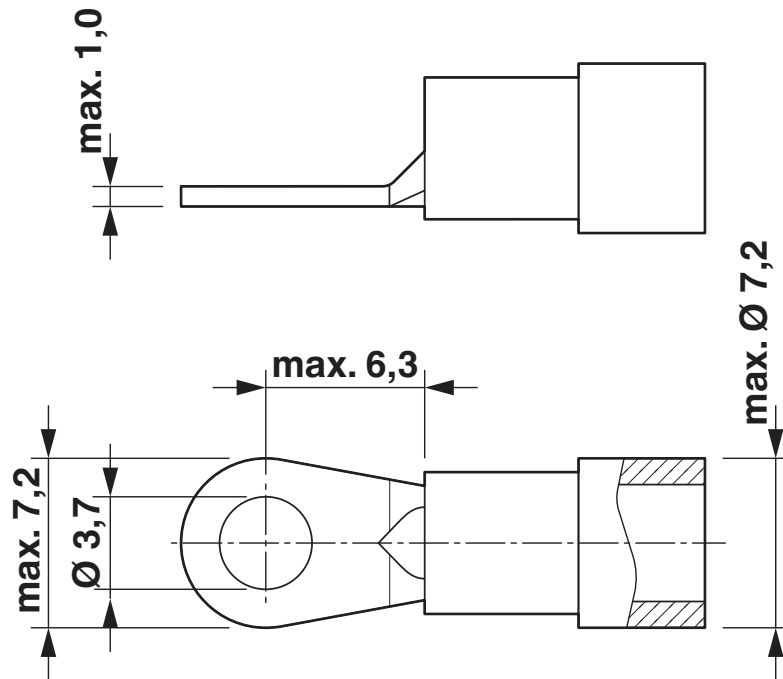

BTFE 6-3/18 4U - Test terminal strip





1029255

<https://www.phoenixcontact.com/pc/products/1029255>

Approvals

To download certificates, visit the product detail page: <https://www.phoenixcontact.com/pc/products/1029255>

 CSA Approval ID: 13631				
	Nominal voltage U_N	Nominal current I_N	Cross section AWG	Cross section mm^2
Use group B	300 V	30 A	20 - 10	-
Use group C	300 V	30 A	20 - 10	-
Use group D	600 V	5 A	20 - 10	-

 cUL Recognized Approval ID: FILE E 60425				
	Nominal voltage U_N	Nominal current I_N	Cross section AWG	Cross section mm^2
Use group B	300 V	30 A	20 - 10	-
Use group C	300 V	30 A	20 - 10	-
Use group F	400 V	30 A	20 - 10	-
Use group D	600 V	5 A	20 - 10	-

 UL Recognized Approval ID: FILE E 60425				
	Nominal voltage U_N	Nominal current I_N	Cross section AWG	Cross section mm^2
Use group B	300 V	30 A	20 - 10	-
Use group C	300 V	30 A	20 - 10	-
Use group F	400 V	30 A	20 - 10	-
Use group D	600 V	5 A	20 - 10	-

cULus Recognized

BTFE 6-3/18 4U - Test terminal strip



1029255

<https://www.phoenixcontact.com/pc/products/1029255>

Classifications

ECLASS

ECLASS-11.0	27141126
ECLASS-12.0	27141126
ECLASS-13.0	27250190

ETIM

ETIM 8.0	EC000902
----------	----------

UNSPSC

UNSPSC 21.0	39121400
-------------	----------

BTFE 6-3/18 4U - Test terminal strip



1029255

<https://www.phoenixcontact.com/pc/products/1029255>

Environmental product compliance

REACH SVHC	Lead 7439-92-1
China RoHS	Environmentally Friendly Use Period = 50 years
	For information on hazardous substances, refer to the manufacturer's declaration available under "Downloads"

BTFE 6-3/18 4U - Test terminal strip

1029255

<https://www.phoenixcontact.com/pc/products/1029255>

Accessories

 Note: Applying some accessories below might limit this product.

FBS 2-8 - Plug-in bridge

3030284

<https://www.phoenixcontact.com/pc/products/3030284>



Plug-in bridge, pitch: 8.2 mm, number of positions: 2, color: red

 Max. current carrying capacity: 24 A

FBS 3-8 - Plug-in bridge

3030297

<https://www.phoenixcontact.com/pc/products/3030297>



Plug-in bridge, pitch: 8.2 mm, number of positions: 3, color: red

 Max. current carrying capacity: 24 A

BTFE 6-3/18 4U - Test terminal strip

1029255

<https://www.phoenixcontact.com/pc/products/1029255>



FBS 4-8 - Plug-in bridge

3030307

<https://www.phoenixcontact.com/pc/products/3030307>



Plug-in bridge, pitch: 8.2 mm, number of positions: 4, color: red

 Max. current carrying capacity: 24 A

FBS 5-8 - Plug-in bridge

3030310

<https://www.phoenixcontact.com/pc/products/3030310>



Plug-in bridge, pitch: 8.2 mm, number of positions: 5, color: red

 Max. current carrying capacity: 24 A

BTFE 6-3/18 4U - Test terminal strip

1029255

<https://www.phoenixcontact.com/pc/products/1029255>



FBS 6-8 - Plug-in bridge

3032470

<https://www.phoenixcontact.com/pc/products/3032470>



Plug-in bridge, pitch: 8.2 mm, number of positions: 6, color: red

 Max. current carrying capacity: 24 A

FBS 10-8 - Plug-in bridge

3030323

<https://www.phoenixcontact.com/pc/products/3030323>



Plug-in bridge, pitch: 8.2 mm, number of positions: 10, color: red

 Max. current carrying capacity: 24 A

BTFE 6-3/18 4U - Test terminal strip

1029255

<https://www.phoenixcontact.com/pc/products/1029255>

FBS 1/3-8 - Plug-in bridge

3032363

<https://www.phoenixcontact.com/pc/products/3032363>



Plug-in bridge, pitch: 8.2 mm, number of positions: 3, pin assignment: 1,3, color: red

 Max. current carrying capacity: 24 A

FBS 1/4-8 - Plug-in bridge

3032376

<https://www.phoenixcontact.com/pc/products/3032376>



Plug-in bridge, pitch: 8.2 mm, number of positions: 4, pin assignment: 1, 4, color: red

 Max. current carrying capacity: 24 A

BTFE 6-3/18 4U - Test terminal strip

1029255

<https://www.phoenixcontact.com/pc/products/1029255>



FBS 1/3/5-8 - Plug-in bridge

3032389

<https://www.phoenixcontact.com/pc/products/3032389>



Plug-in bridge, pitch: 8.2 mm, number of positions: 5, pin assignment: 1,3,5, color: red

 Max. current carrying capacity: 24 A

FBS 1/4/7/10-8 - Plug-in bridge

3032402

<https://www.phoenixcontact.com/pc/products/3032402>



Plug-in bridge, pitch: 8.2 mm, number of positions: 10, pin assignment: 1,4,7,10, color: red

 Max. current carrying capacity: 24 A

BTFE 6-3/18 4U - Test terminal strip

1029255

<https://www.phoenixcontact.com/pc/products/1029255>



FBSR 5-8 - Plug-in bridge

3033809

<https://www.phoenixcontact.com/pc/products/3033809>



Plug-in bridge, pitch: 8.2 mm, number of positions: 5, color: red

 Max. current carrying capacity: 24 A

FBS 2-8 CT - Plug-in bridge

3033830

<https://www.phoenixcontact.com/pc/products/3033830>



Plug-in bridge, pitch: 8.2 mm, number of positions: 2, color: orange

 Max. current carrying capacity: 24 A

BTFE 6-3/18 4U - Test terminal strip

1029255

<https://www.phoenixcontact.com/pc/products/1029255>



FBS 3-8 CT - Plug-in bridge

3033831

<https://www.phoenixcontact.com/pc/products/3033831>



Plug-in bridge, pitch: 8.2 mm, number of positions: 3, color: orange

 Max. current carrying capacity: 24 A

FBS 4-8 CT - Plug-in bridge

3033832

<https://www.phoenixcontact.com/pc/products/3033832>



Plug-in bridge, pitch: 8.2 mm, number of positions: 4, color: orange

 Max. current carrying capacity: 24 A

BTFE 6-3/18 4U - Test terminal strip

1029255

<https://www.phoenixcontact.com/pc/products/1029255>



FBS 10-8 CT - Plug-in bridge

3033833

<https://www.phoenixcontact.com/pc/products/3033833>



Plug-in bridge, pitch: 8.2 mm, number of positions: 10, color: orange

 Max. current carrying capacity: 24 A

FBS 2-8 BU - Plug-in bridge

3032567

<https://www.phoenixcontact.com/pc/products/3032567>



Plug-in bridge, pitch: 8.2 mm, number of positions: 2, color: blue

 Max. current carrying capacity: 24 A

BTFE 6-3/18 4U - Test terminal strip

1029255

<https://www.phoenixcontact.com/pc/products/1029255>



FBS 3-8 BU - Plug-in bridge

3032570

<https://www.phoenixcontact.com/pc/products/3032570>



Plug-in bridge, pitch: 8.2 mm, number of positions: 3, color: blue

 Max. current carrying capacity: 24 A

FBS 4-8 BU - Plug-in bridge

3032583

<https://www.phoenixcontact.com/pc/products/3032583>



Plug-in bridge, pitch: 8.2 mm, number of positions: 4, color: blue

 Max. current carrying capacity: 24 A

BTFE 6-3/18 4U - Test terminal strip

1029255

<https://www.phoenixcontact.com/pc/products/1029255>



FBS 5-8 BU - Plug-in bridge

3032596

<https://www.phoenixcontact.com/pc/products/3032596>



Plug-in bridge, pitch: 8.2 mm, number of positions: 5, color: blue

 Max. current carrying capacity: 24 A

FBS 6-8 BU - Plug-in bridge

3032677

<https://www.phoenixcontact.com/pc/products/3032677>



Plug-in bridge, pitch: 8.2 mm, number of positions: 6, color: blue

 Max. current carrying capacity: 24 A

BTFE 6-3/18 4U - Test terminal strip

1029255

<https://www.phoenixcontact.com/pc/products/1029255>



FBS 10-8 BU - Plug-in bridge

3032606

<https://www.phoenixcontact.com/pc/products/3032606>



Plug-in bridge, pitch: 8.2 mm, number of positions: 10, color: blue

 Max. current carrying capacity: 24 A

FTP-3F/18 4U - Test plug

1029273

<https://www.phoenixcontact.com/pc/products/1029273>



Test plug, nom. voltage: 400 V, nominal current: 20 A, Rated cross section: 2.5 mm², color: gray

BTFE 6-3/18 4U - Test terminal strip

1029255

<https://www.phoenixcontact.com/pc/products/1029255>



FBP-3F 4U - Blind plug

1029279

<https://www.phoenixcontact.com/pc/products/1029279>



Blind plug, color: gray

TMT (EX6,2)R - Marker for terminal blocks

0803063

<https://www.phoenixcontact.com/pc/products/0803063>



Marker for terminal blocks, Roll, white, unlabeled, can be labeled with: THERMOMARK E.300 (D)/600 (D), THERMOMARK ROLL 2.0, THERMOMARK ROLL, THERMOMARK ROLL X1, THERMOMARK ROLLMASTER 300/600, THERMOMARK X1.2, mounting type: snapped, snap into flat marker groove, lettering field size: 6.2 x 50000 mm, Number of individual labels: 1

BTFE 6-3/18 4U - Test terminal strip

1029255

<https://www.phoenixcontact.com/pc/products/1029255>



US-TMF 100 - Marker for terminal blocks

0829260

<https://www.phoenixcontact.com/pc/products/0829260>



Marker for terminal blocks, Card, white, unlabeled, can be labeled with: BLUEMARK ID COLOR, BLUEMARK ID, THERMOMARK PRIME, THERMOMARK CARD 2.0, THERMOMARK CARD, mounting type: snapped, snap into flat marker groove, lettering field size: 104 x 6.6 mm, Number of individual labels: 20

PAI-4-N GY - Test adapter

3032871

<https://www.phoenixcontact.com/pc/products/3032871>



4 mm test adapter, for terminal blocks with 5.2 mm, 6.2 mm and 8.2 mm pitch

BTFE 6-3/18 4U - Test terminal strip

1029255

<https://www.phoenixcontact.com/pc/products/1029255>

SF-PH 2-100 - Screwdriver

1212560

<https://www.phoenixcontact.com/pc/products/1212560>



Screwdriver, PH crosshead (lasered), uninsulated, size: PH 2 x 100, 2-component grip, with non-slip grip

SF-PH 2-100 S-VDE - Screwdriver

1212694

<https://www.phoenixcontact.com/pc/products/1212694>



Screwdriver, crosshead PH (lasered), insulated, size: PH 2 x 100, 2-component handle, with non-slip grip

BTFE 6-3/18 4U - Test terminal strip

1029255

<https://www.phoenixcontact.com/pc/products/1029255>

C-RCI 1,5/M3,5 - Ring cable lug

3240017

<https://www.phoenixcontact.com/pc/products/3240017>



Ring cable lug, red, 0.5 ... 1.5 mm², M3.5

C-RCI 2,5/M3,5 - Ring cable lug

3240022

<https://www.phoenixcontact.com/pc/products/3240022>



Ring cable lug, blue, 1.5 ... 2.5 mm², M3.5

BTFE 6-3/18 4U - Test terminal strip

1029255

<https://www.phoenixcontact.com/pc/products/1029255>



ZBF 8:UNBEDRUCKT - Zack Marker strip, flat

0808781

<https://www.phoenixcontact.com/pc/products/0808781>



Zack Marker strip, flat, Strip, white, unlabeled, can be labeled with: PLOTMARK, CMS-P1-PLOTTER, mounting type: snapped, for terminal block width: 8 mm, lettering field size: 5.15 x 8.15 mm, Number of individual labels: 10

ZBF 8 CUS - Zack Marker strip, flat

0825030

<https://www.phoenixcontact.com/pc/products/0825030>



Zack Marker strip, flat, can be ordered: Strip, white, labeled according to customer specifications, mounting type: snap into flat marker groove, for terminal block width: 8 mm, lettering field size: 5.15 x 8.15 mm, Number of individual labels: 10

BTFE 6-3/18 4U - Test terminal strip

1029255

<https://www.phoenixcontact.com/pc/products/1029255>



ZBF 8,LGS:FORTL.ZAHLEN - Zack Marker strip, flat

0808804

<https://www.phoenixcontact.com/pc/products/0808804>



Zack Marker strip, flat, Strip, white, labeled, printed horizontally: consecutive numbers 1 ... 10, 11 ... 20, etc. up to 101 ... 110, mounting type: snapped, for terminal block width: 8 mm, lettering field size: 5.15 x 8.15 mm, Number of individual labels: 10

UC-TMF 8 - Marker for terminal blocks

0818137

<https://www.phoenixcontact.com/pc/products/0818137>



Marker for terminal blocks, Sheet, white, unlabeled, can be labeled with: BLUEMARK ID COLOR, BLUEMARK ID, BLUEMARK CLED, PLOTMARK, CMS-P1-PLOTTER, mounting type: snapped, for terminal block width: 8.2 mm, lettering field size: 7.6 x 5.1 mm, Number of individual labels: 56

BTFE 6-3/18 4U - Test terminal strip

1029255

<https://www.phoenixcontact.com/pc/products/1029255>



UC-TMF 8 CUS - Marker for terminal blocks

0824654

<https://www.phoenixcontact.com/pc/products/0824654>



Marker for terminal blocks, can be ordered: by sheet, white, labeled according to customer specifications, mounting type: snap into flat marker groove, for terminal block width: 8.2 mm, lettering field size: 7.6 x 5.1 mm, Number of individual labels: 56

UCT-TMF 8 - Marker for terminal blocks

0828748

<https://www.phoenixcontact.com/pc/products/0828748>



Marker for terminal blocks, Sheet, white, unlabeled, can be labeled with: TOPMARK NEO, TOPMARK LASER, BLUEMARK ID COLOR, BLUEMARK ID, BLUEMARK CLED, THERMOMARK PRIME, THERMOMARK CARD 2.0, THERMOMARK CARD, mounting type: snapped, for terminal block width: 8.2 mm, lettering field size: 7.4 x 4.7 mm, Number of individual labels: 42

BTFE 6-3/18 4U - Test terminal strip

1029255

<https://www.phoenixcontact.com/pc/products/1029255>



UCT-TMF 8 CUS - Marker for terminal blocks

0829672

<https://www.phoenixcontact.com/pc/products/0829672>



Marker for terminal blocks, can be ordered: by sheet, white, labeled according to customer specifications, mounting type: snap into flat marker groove, for terminal block width: 8.2 mm, lettering field size: 7.4 x 4.7 mm, Number of individual labels: 42

Phoenix Contact 2023 © - all rights reserved

<https://www.phoenixcontact.com>

PHOENIX CONTACT GmbH & Co. KG

Flachsmarktstraße 8

D-32825 Blomberg

+49 (0) 5235-3 00

info@phoenixcontact.com