

4

3

2



1

THIS DRAWING IS UNPUBLISHED. RELEASED FOR PUBLICATION AUG 2008
 © COPYRIGHT 2009 BY TYCO ELECTRONICS CORPORATION. ALL RIGHTS RESERVED.

LOC	DIST	REVISIONS					
		#	LR	DESCRIPTION	DATE	DRN	APPD
DW		C6		REVISED (ECR-15-013726)	1MAR2016	A.X	H.W

OBSOLETE

- 7-1734038-1
 - 6-1734038-1
 - 5-1734038-1
 - 4-1734038-2
 - 3-1734038-3
 - 3-1734038-2
 - 3-1734038-1
 - 2-1734038-1
 - 1-1734038-2
 - 1-1734038-1
 - 1734038-3
 - 1734038-2
 - 1734038-1
- PART NUMBER

THIS DRAWING IS A CONTROLLED DOCUMENT.		DRN F. YANG 31.JUL.2009	 TE Connectivity	
		CHK S. CHIEN 31.JUL.2009		
DIMENSIONS: MM		APRD W. KODAMA 31.JUL.2009	NAME	
		PRODUCT SPEC 108-57549		USB CONNECTOR, RECEPTACLE, R/A, A TYPE
TOLERANCES UNLESS OTHERWISE SPECIFIED: 0 PLC ± - 1 PLC ± 0.3 2 PLC ± 0.2 3 PLC ± 0.15 4 PLC ± ± 3'		APPLICATION SPEC		
MATERIAL	FINISH	WEIGHT 1.82 GRAMS	SIZE A3	GAGE CODE 00779
SEE NOTE	SEE NOTE	CUSTOMER DRAWING	DRAWING NO C=1734038	RESTRICTED TO
			SCALE	SHEET 1 OF 4
			REV	C6

LOC	DIST	REVISIONS			
P	LYR	DESCRIPTION	DATE	DM	APVD
		SEE SHEET 1.			

TE LOGO & DATE CODE

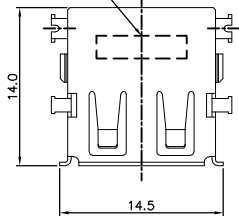

NOTES:

- MATERIAL:
HOUSING: (SEE TABLE) WITH 30% GF, UL 94V-0. BLACK COLOR.
CONTACT: PHOSPHOR BRONZE.
SHELL: BRASS.
- FINISH:
CONTACT: 0.762µm [30µ"] MIN. GOLD PLATING ON CONTACT AREA.
3.048µm [120µ"] MIN. MATTE TIN PLATING ON SOLDER TAIL.
WITH ENTIRE CONTACT UNDERPLATED 1.270µm [50µ"] MIN. NICKEL.
SHELL: 0.762µm [30µ"] MIN. NICKEL PLATING OVER 0.762µm [30µ"] MIN. Cu UNDERPLATED.
- REFLOW SOLDER CAPABLE TO 260°C PER TE SPEC 109-201, CONDITION B.

NO BOARD LOCK FUNCTION APPLIED.

LOW HALOGEN SPECIFICATION:
CHLORINE(Cl): 900ppm MAX.
BROMINE(Br): 900ppm MAX.

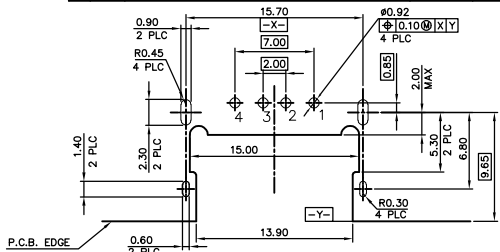
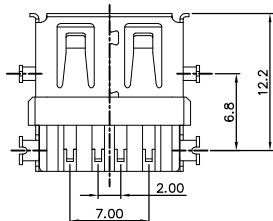
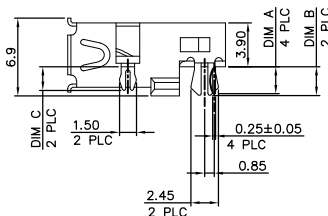
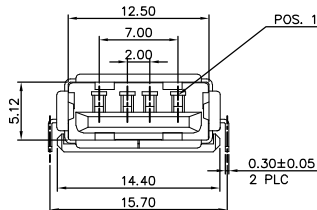

RECOMMEND P.C.B LAYOUT (THICKNESS 1.2~1.4mm)
(COMPONENT SIDE) TOLERANCE±0.05

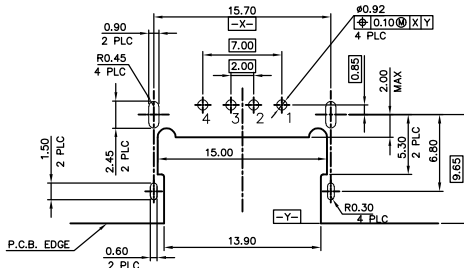

RECOMMEND P.C.B LAYOUT (THICKNESS=1.0~1.4mm) ▲
(COMPONENT SIDE) TOLERANCE±0.05

TAPE & REEL	2.40	2.55	2.10	HTN	B-1734038-4
	1.80	1.80	1.80	PAGT	B-1734038-2
PACKAGING	2.40	2.55	2.10		B-1734038-1
	DIM A	DIM B	DIM C	FINISH	MATERIAL

OBSOLETE

THIS DRAWING IS A CONTROLLED DOCUMENT.

DIMENSIONS:		TOLERANCES UNLESS OTHERWISE SPECIFIED:	
MM		0 PLC	± .3
		1 PLC	± 0.3
		2 PLC	± 0.2
		3 PLC	± 0.15
		4 PLC	± .3
		ANGLES	± .3°
MATERIAL	SEE NOTE	FINISH	SEE NOTE

DM	CRK	APVD	NAME
PRODUCT SPEC	APPLICATION SPEC	SIZE	CAGE CODE
WEIGHT	1.56 GRAMS	DRAWING NO	A300779
CUSTOMER DRAWING		DRAWING NO	C=1734038
SCALE		SHEET	2 of 4
REV	C6	RESTRICTED	



USB CONNECTOR, RECEPTACLE, R/A, A TYPE

4

3

2

1

THIS DRAWING IS UNPUBLISHED. RELEASED FOR PUBLICATION AUG 2008
 © COPYRIGHT 2009 BY TYCO ELECTRONICS CORPORATION. ALL RIGHTS RESERVED.

LOC	DIST	REVISIONS			
#	LTR	DESCRIPTION	DATE	DNM	APVD
		SEE SHEET 1.			

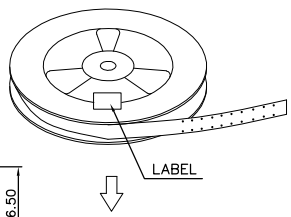
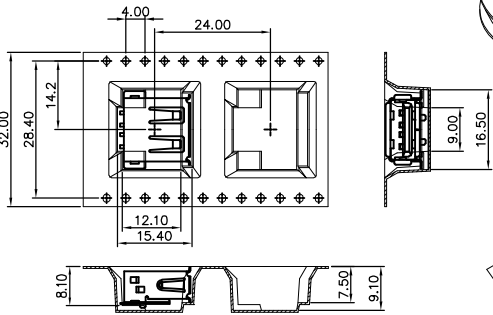
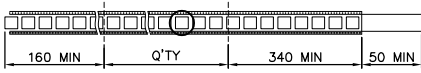

- NOTES:
 1. MATERIAL:
 REEL: PS.
 CARRIER: PS.
 COVER TAPE: PBT.
 2. DIMENSION
 REEL: #330mmX37.1mm
 SHIPPING CARTON: L=350mm,W=350mm,H=250mm
 3. QUANTITY:
 PRIMARY PACKING: 300PCS/REEL
 SECONDARY PACKING: 9REELS/CARTON(2,700PCS).
 4. WEIGHT:
 NET WEIGHT: 0.46KG/REEL, 4.15 KG/CARTON.
 GROSS WEIGHT: 0.97 KG/REEL, 9.7 KG/CARTON.
 5. PEELING RESISTANCE: 20G TO 130G.
 6. PEELING SPEED: 300MM/MIN.

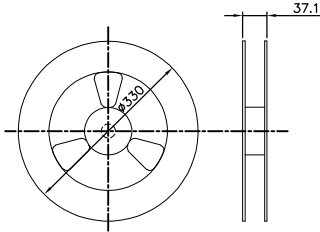
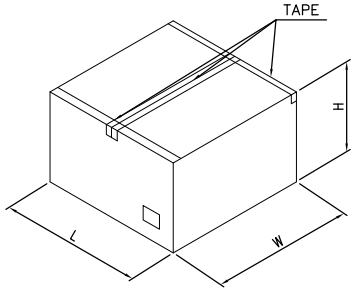
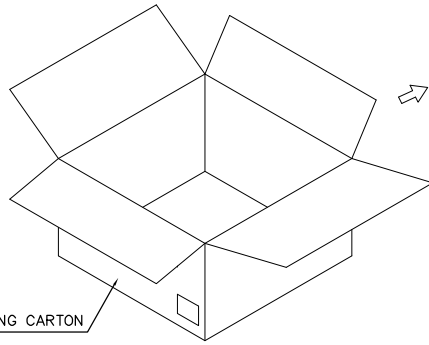

OBSOLETE 6-1734038-1
 PART NUMBER

THIS DRAWING IS A CONTROLLED DOCUMENT.		DWM		TE Connectivity USB CONNECTOR, RECEPTACLE, R/A, A TYPE	
DIMENSIONS: MM		TOLERANCES UNLESS OTHERWISE SPECIFIED:			
0 PLC ± 1 PLC ± 2 PLC ± 3 PLC ± 4 PLC ± 5 PLC ± 6 PLC ± 7 PLC ± 8 PLC ± 9 PLC ±		0.15 ± 0.25 ± 0.50 ± 1.00 ± 1.50 ± 2.00 ± 3.00 ± 4.00 ± 5.00 ± 6.00 ± 8.00 ± 10.00 ±		PRODUCT SPEC	
MATERIAL		FINISH		APPLICATION SPEC	
				WEIGHT	
				SIZE	
				CAGE CODE	
				DRAWING NO	
				RESTRICTED TO	
				A300779 C=1734038	
				CUSTOMER DRAWING	
				SCALE	
				SHEET 3 of 4	
				REV C6	

LOC	DIST	REVISIONS			
REV	DATE	DESCRIPTION	DATE	DRN	APVD
1		SEE SHEET 1.			

PULL OUT DIRECTION

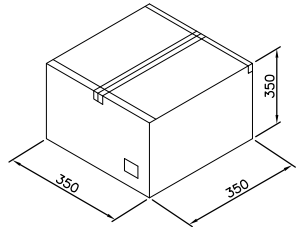
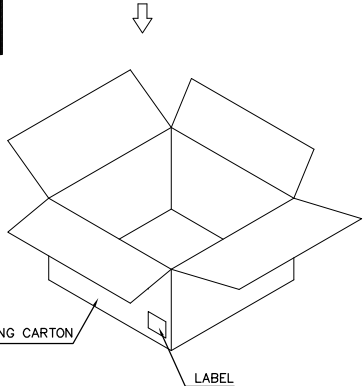
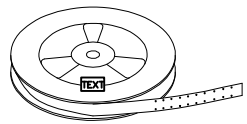
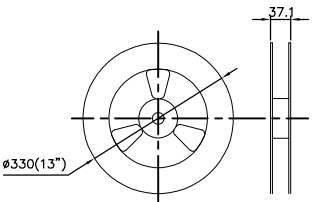
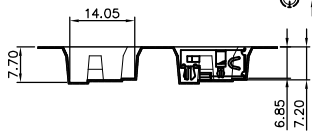
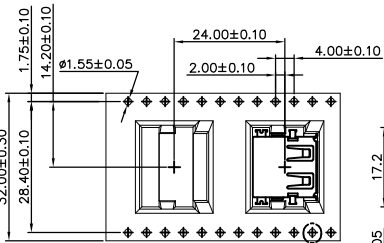

- NOTES:
1. MATERIAL:
REEL: PS.
CARRIER: PS.
COVER TAPE: PBT.
 2. DIMENSION
REEL: Ø330mmX37.1mm
 3. PEELING RESISTANCE: 20G TO 130G.
 4. PEELING SPEED: 300MM/MIN.

TAPE & REEL	8.92 Kg	4.91 Kg	350	9	3150 PCS	8-1734038-4
PACKAGING	GROSS WEIGHT	NET WEIGHT	PCS/REEL	REELS/CARTON	QUANTITY	PART NUMBER
						8-1734038-4

OBSOLETE

THIS DRAWING IS A CONTROLLED DOCUMENT.

DIMENSIONS:		TOLERANCES UNLESS OTHERWISE SPECIFIED:	
MM			
	0 PLC	±	-
	1 PLC	±	-
	2 PLC	±	-
	3 PLC	±	-
	4 SDC	±	-
	ANGLES	±	-
MATERIAL	FINISH		

DRN	CHK	APVD	NAME
			STE TE Connectivity
PRODUCT SPEC	USB CONNECTOR, RECEPTACLE, R/A, A TYPE		
APPLICATION SPEC			
SIZE	CAGE CODE	DRAWING NO	RESTRICTED TO
A3	300779	C-1734038	
CUSTOMER DRAWING	SCALE	SHEET	REV
		4 of 4	C6