

S18-275VPD-RICB1E

Digital Ferrous Metal Detection Sensor

- Ferrous Metal Hall Proximity Sensor
- .375" detection gap
- PNP output
- Stainless 18x1mm x 53mm housing
- 4 pin male micro connector on 11" jacketed pur cable



CUSTOMER FOCUSED ENGINEERING + MODULAR DESIGN

Part Description: **S18-275VPD-RICB1E**

Housing	Sensor Type & Function	Electrical Option	Connection Type
S = Stainless Steel, Thread Pitch M18x1, 53mm Long	Digital Ferrous Metal Proximity Sensor	RI Regulated In, PNP	4 Pin Male Micro Conn. on 11" Jacketed Pur Cable

Modify, update, or enhance any sensor with our modular features and functionality.

HOUSING - Aluminum, stainless steel, plastic, threaded, flange mount, customer specific

ELECTRICAL - Every sensor function available in various electrical options (NPN, PNP, TTL, etc.)

CONNECTION - Deutsch, Amphenol, many other brands, free end wires, pigtails, any length

Need a Custom Sensor Solution?... Send us your application specific requirements at sensorso.com

'Digital Output switches on when Ferrous Metal is present'

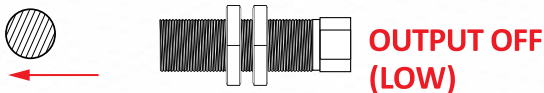
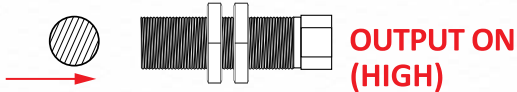

Type - DP

DESCRIPTION

- Digital output turns on when ferrous metal is detected
- Programmed to detect a large steel target at 0.375"
- Target detection gap is dependent on shape/size/ferrous content.
- Custom programming available for precision repeatable detection of targets, contact Sensor Solutions.
- Provided lock nuts used to set air gap from target.

FEATURES

- True Zero Speed
- Large Detection Gap
- Internal Hysteresis
- Detects Through Aluminum

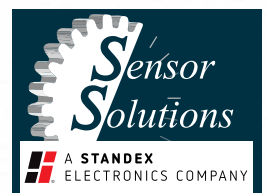

S18-275VPD-RICB1E

Digital Ferrous Metal Detection Sensor

Note: Check our website or contact us for details on all our ferrous metal detection options.

Electrical Specifications	Conditions	Min	Max	Unit
Temperature Range*	Operating	-20	+85	Deg C
Supply Voltage, Vcc	Operating	+8.0	+30	Volts DC
Supply Current	Into Vcc, Vout Low	(typ 8)	+16	mA
Output Resistance	Inside Sensor, Vo-Vout	256	285	mA
Frequency Range **		0	500***	Hz
Digital Voltage Low Vol	Rload = 1k	0	0.6	Volts
Digital Voltage High Voh	Vcc = 24, Rload = 1k	18	20	Volts
Output Rise Time 10-90%	Rload=1k, C<100 pF	-	1	µS
Output Fall Time 90-10%	Rload=1k, C<100 pF	-	10	µS
Output Capacitance, Vout-Gnd	Inside Sensor	-	540	pF
Input Capacitance, Vcc-Gnd	Inside Sensor	-	5400	pF

*** Can be programmed for operation up to 2000 Hz, contact factory.

Rev B

Absolute Max Limits	Min	Max	Unit
Supply Voltage, Vcc	-24	+30	Volts DC
Voltage at Output	-5	+30	Volts
Reverse Supply Current	-	5.0	mA
Peak Output Current	-10	+10	mA
Vout Short Circuit Duration	-	10	Minutes

Environmental Specifications

Corrosion Resistance	500 hours salt spray ASTM B-117
Installation Torque	60 Foot-Pounds Maximum
Enclosure	Nema 1,3,4,6,13 & IEC IP67
Vibration	10 G's 2 to 2000 Hz Sinusoidal
Mechanical Shock	100 G's, 11 mS Half-Sine

S18 Housing, 303 Stainless Steel, M18X1, 53mm Long

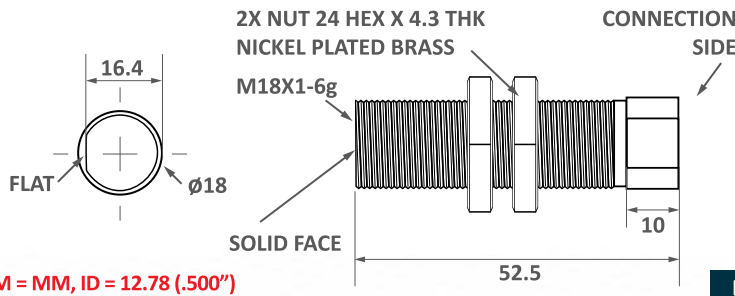

DIM = MM, ID = 12.78 (.500")

Rev E

Functional Characteristics @25°C

	Min	Typ	Max
<i>Sensor Programming + target ferrous content, shape, & size will affect gaps</i>			
Output State, No Target Present: Low (~0V)			
Detect Large Steel Target T=25C**	0.350"	0.375"	0.400"
Hysteresis, Large Steel Target T=25C**	.020"	.050"	.080"
Detect 0.5" ø Steel Target	-	.360"	-
Detect 0.1" ø Steel Target	-	.215"	-

** Frequency, Detection and Hysteresis are Factory Programmable and can be decreased upon request.

CB1E, 4 Pin Male 12mm Micro Connector w/11" Pur Cable

CONNECTOR: 4 PIN MALE M12 STRAIGHT OVERMOLD
CABLE: 22AWG, STRANDED, PUR JACKET & INSULATION

PIN 1 = RED
PIN 2 = BLACK
PIN 3 = WHITE
PIN 4 = GREEN

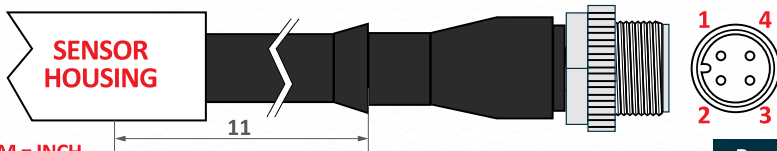

DIM = INCH

Rev A

Connections Chart

Pin 1 Vcc	Pin 3 Ground
Pin 2 Digital Vout	Pin 4 Program, Leave Open

CB1E-275VPD



Caution: A short from the Pin 4 (Green) Program wire to either Pin 1 (Red) Vcc or Pin 2 (Black) Ground wire will cause component failure.

S18-275VPD-RICB1E

Digital Ferrous Metal Detection Sensor

Sensor Function

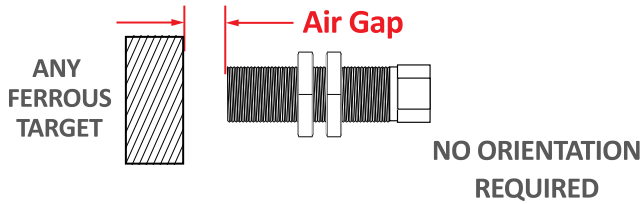

S18-275VPD

RI, Regulated in, PNP

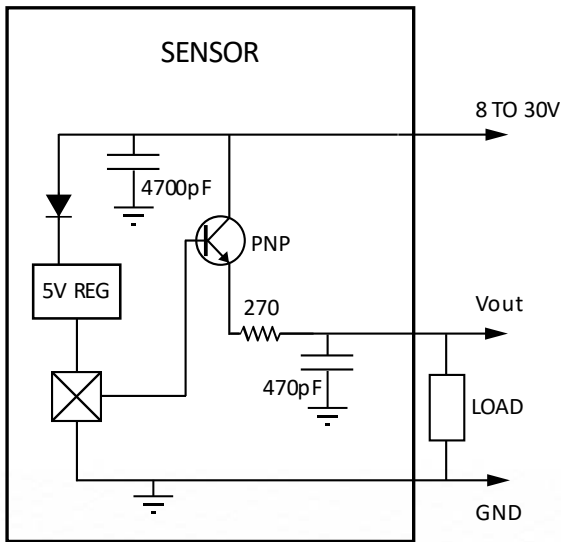

Date Code 'YYM'

YY = YEAR, M = MONTH			
A JAN	D APR	H JUL	L OCT
B FEB	E MAY	J AUG	M NOV
C MAR	G JUN	K SEP	N DEC

Marking

CHARACTERISTIC-OPTION_PROGRAMMING MARKED ON THIS SURFACE yy = PROGRAM #

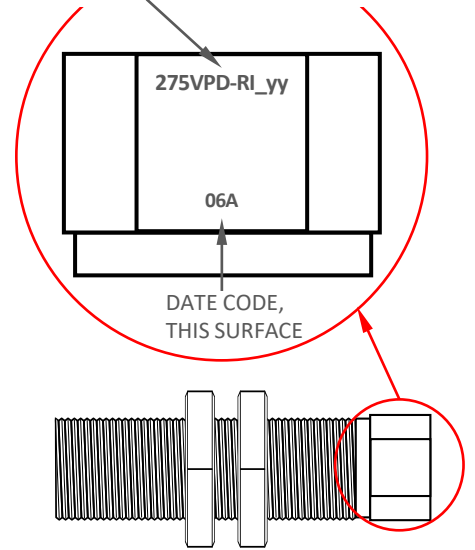

Handling Instructions

DO NOT CONTACT FACE TO FACE

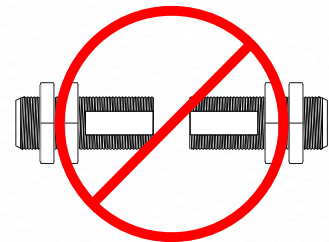

CONTACT WITH OTHER MAGNETS MAY REDUCE THE MAXIMUM OPERATING GAP

Please note: All technical specifications on this series datasheet refer to the standard product range. Modifications in the sense of technical progress are reserved. For general information only. For more specific information, please consult the product datasheet, available upon request.

This series datasheet could contain technical inaccuracies or typographical errors. Changes are periodically made to the information herein. These change will be incorporated in future revisions.

For deviating values, most current specifications and products please contact your nearest sales office.