

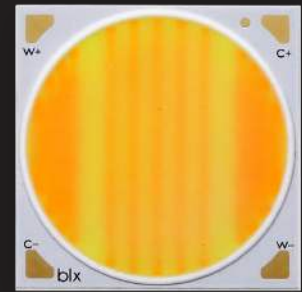
# Bridgelux® Vesta® Series Tunable White Gen 2 29mm Array

Product Data Sheet DS355



# Introduction

Vesta® Series



Vesta® Series Tunable White Array products deliver adaptable light in a solid state lighting package. Vesta Series products tap into the powerful mediums of light and color to influence experience, well-being, and human emotion. They allow designers to mimic daylight to increase productivity and well-being, retailers to influence shopper behavior and fixture manufacturers to simulate the familiar glow and dimming of incandescent lamps. This high flux density light source is designed to support a wide range of high quality directional luminaires and replacement lamps for commercial and residential applications.

Lighting system designs incorporating these LED arrays deliver comparable performance to 150 Watt incandescent-based luminaires, while increasing system level efficacy and prolonging service life. Typical luminaire and lamp types appropriate for this family include replacement lamps, down lights, wall packs and accent, spot and track lights.

## Features

- Tuning range from 2700K-5000K and 2700K-6500K
- Efficacy of 126 lm/W typical
- Uniform, high quality illumination
- Minimum 90 CRI option
- More energy efficient than incandescent, halogen and fluorescent lamps
- Industry standardized dimensions
- Flux packages from 5500 to 7000 lumens typical
- 3 SDCM bin options for both warm white (2700K) and cool white (5000K and 6500K)

## Benefits

- Superior color mixing enabled by phosphor dispensed technology
- Compact system design
- High quality, true color reproduction
- Reliable operation facilitated by high conductivity substrates
- Enhanced optical control
- Uniform, consistent white light

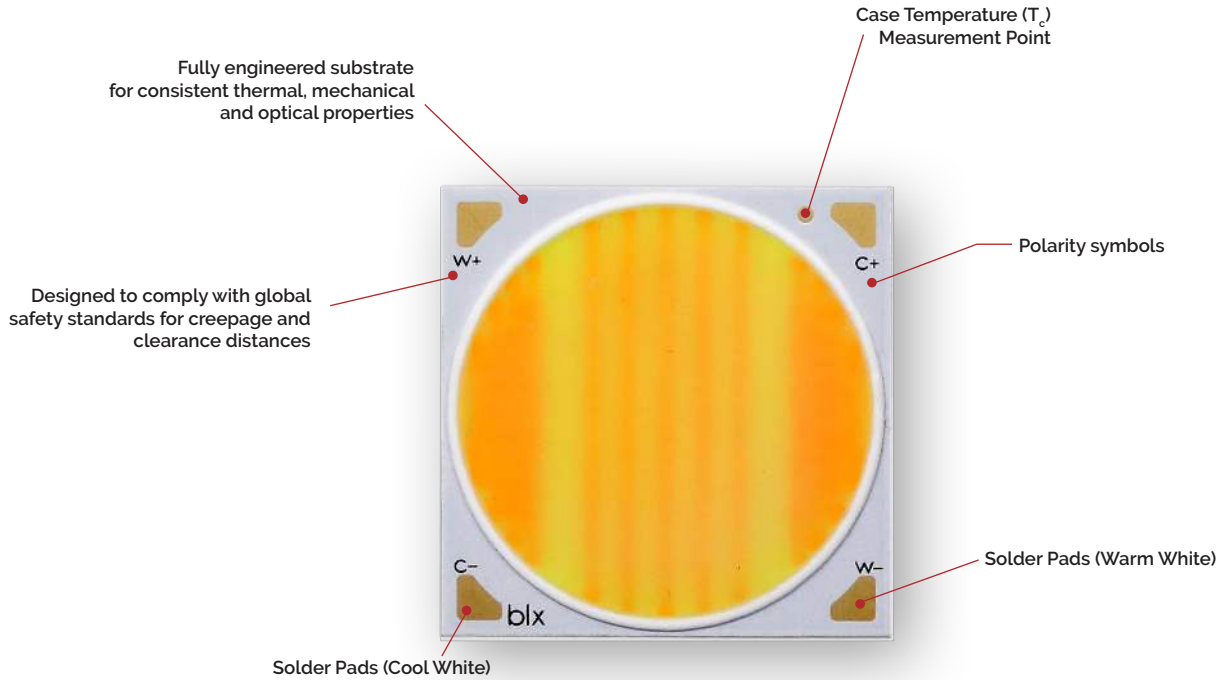


# Contents

Product Feature Map	2
Product Nomenclature	2
Product Selection Guide	3
Electrical Characteristics	4
Absolute Maximum Ratings	5
Performance Curves	6
Typical Radiation Pattern	8
Typical Color Spectrum	9
Mechanical Dimensions	10
Color Binning Information	11
Packaging and Labeling	12
Design Resources	13
Precautions	13
Disclaimers	13
About Bridgelux	14

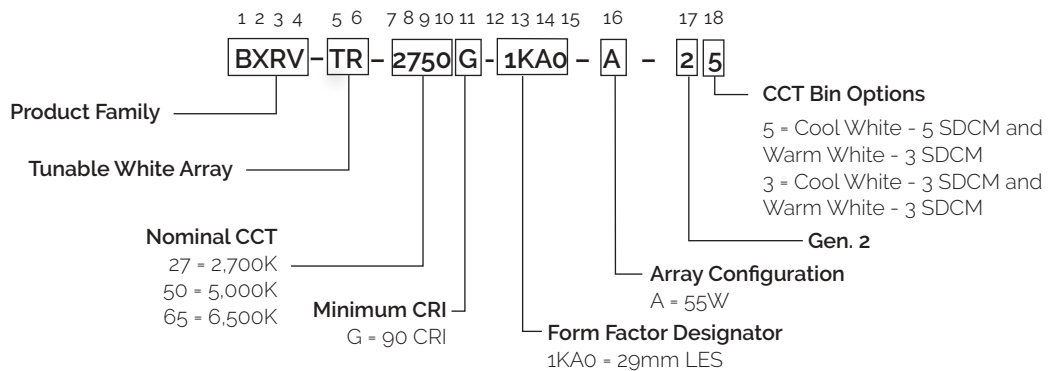
# Product Feature Map

Bridgelux arrays are fully engineered devices that provide consistent thermal and optical performance on an engineered mechanical platform. The arrays incorporate several features to simplify design integration and assembly. Please visit [www.bridgelux.com](http://www.bridgelux.com) for more information on the Vesta Series family of products.



## Product Nomenclature

The part number designation for Bridgelux Vesta Series arrays is explained as follows:



# Product Selection Guide

The following product configurations are available:

**Table 1:** Selection Guide, Measurement Data

Part Number	Nominal CCT <sup>1</sup> (K)	CRI <sup>2</sup>	Nominal Drive Current <sup>3</sup> (per channel) (mA)	Typical V <sub>f</sub> T <sub>c</sub> =25°C (V)	Typical Power T <sub>c</sub> =25°C (W)	Typical Efficacy T <sub>c</sub> =25°C (lm/W)	Typical Pulsed Flux <sup>4,5,6</sup> T <sub>c</sub> =25°C (lm)	Minimum Pulsed Flux T <sub>c</sub> =25°C <sup>9</sup> (lm)	Typical DC Flux T <sub>c</sub> =85°C <sup>7,8</sup> (lm)
BXRV-TR-2750G-1KA0-A-2x	2700	92	1050	52.1	54.7	113	6182	5563	5563
	5000	92	1050	52.4	55.0	125	6878	6190	6052
BXRV-TR-2765G-1KA0-A-2x	2700	92	1050	52.1	54.7	113	6182	5563	5563
	6500	92	1050	52.4	55.0	128	7043	6338	6197

**Notes for Table 1:**

1. Nominal CCT as defined by ANSI C78.377-2011.
2. Minimum CRI value is 90. Minimum R9 value for 90 CRI products is 50, Bridgelux maintains a ±3 tolerance on all R9 values.
3. Refer to Table 3 for maximum drive current conditions.
4. Products tested under pulsed condition (10ms pulse width) at nominal test current where T<sub>j</sub> (junction temperature) = T<sub>c</sub> (case temperature) = 25°C.
5. Typical performance values are provided as a reference only and are not a guarantee of performance.
6. Bridgelux maintains a ±7% tolerance on flux measurements.
7. Typical stabilized DC performance values are provided as reference only and are not a guarantee of performance.
8. Typical performance is estimated based on operation under DC (direct current) with LED array mounted onto a heat sink with thermal interface material and the case temperature maintained at 85°C. Based on Bridgelux test setup, values may vary depending on the thermal design of the luminaire and/or the exposed environment to which the product is subjected.
9. Minimum flux values at the nominal test current are guaranteed by 100% test.

# Electrical Characteristics

**Table 2:** Electrical Characteristics

Part Number	CCT	Nominal Drive Current (mA)	Forward Voltage Pulsed, $T_c = 25^\circ\text{C}$ (V) <sup>1, 2, 3, 7</sup>			Typical Temperature Coefficient of Forward Voltage <sup>4</sup> $\Delta V_f / \Delta T_c$ (mV/ $^\circ\text{C}$ )	Typical Thermal Resistance Junction to Case <sup>5</sup> $R_{j-c}$ ( $^\circ\text{C}/\text{W}$ )	Driver Selection Voltages <sup>6</sup> (V)	
			Minimum	Typical	Maximum			$V_f$ Min. Hot $T_c = 105^\circ\text{C}$ (V)	$V_f$ Max. Cold $T_c = -40^\circ\text{C}$ (V)
BXRV-TR-27xxG-1KA0-A-2x	2700	1050	49.0	52.1	55.2	-17.2	0.12	47.6	56.4
	5000/6500K	1050	49.3	52.4	55.6	-18.2		47.9	56.7

Notes for Table 2:

1. Parts are tested in pulsed conditions,  $T_c = 25^\circ\text{C}$ . Pulse width is 10ms.
2. Voltage minimum and maximum are provided for reference only and are not a guarantee of performance.
3. Bridgelux maintains a tester tolerance of  $\pm 0.10\text{V}$  on forward voltage measurements.
4. Typical temperature coefficient of forward voltage tolerance is  $\pm 0.1\text{mV}$  for nominal current.
5. Thermal resistance value was calculated using total electrical input power; optical power was not subtracted from input power. The thermal interface material used during testing is not included in the thermal resistance value.
6.  $V_f$  min hot and max cold values are provided as reference only and are not guaranteed by test. These values are provided to aid in driver design and selection over the operating range of the product.
7. This product has been designed and manufactured per IEC 62031:2014. This product has passed dielectric withstand voltage testing at 500 V. The working voltage designated for the insulation is 45V DC. The maximum allowable voltage across the array must be determined in the end product application.

# Absolute Maximum Ratings

**Table 3:** Maximum Ratings

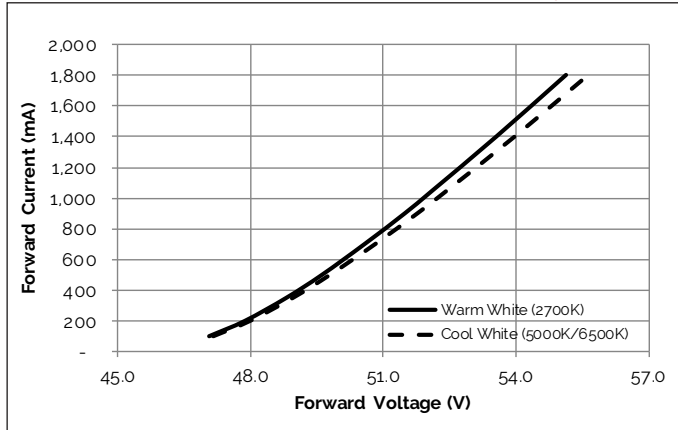
Parameter	Maximum Rating	
LED Junction Temperature ( $T_j$ )	125°C	
Storage Temperature	-40°C to +105°C	
Operating Case Temperature <sup>1</sup> ( $T_c$ )	105°C	
Soldering Temperature <sup>2</sup>	300°C or lower for a maximum of 6 seconds	
Maximum Total Drive Current <sup>4</sup>	1800mA	
	Warm White 2700K	Cool White 5000K/6500K
Maximum Drive Current Per Channel <sup>3,4</sup>	1800mA	1800mA
Maximum Peak Pulsed Drive Current <sup>5</sup>	2100mA	1900mA
Maximum Total Power	96.1W	

Notes for Table 3:

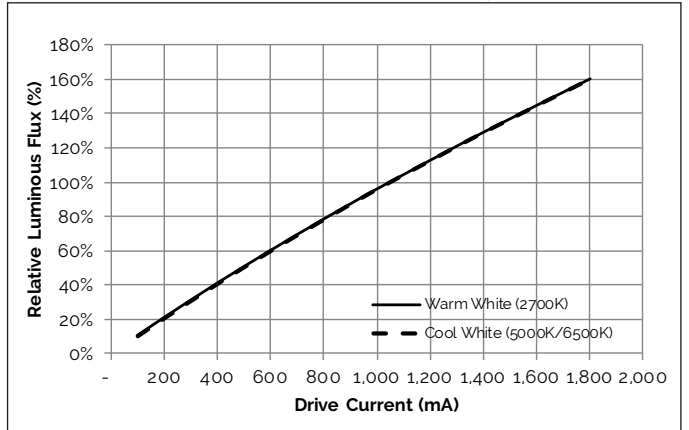
1. For IEC 62717 requirement, please contact Bridgelux Sales Support.
2. See Bridgelux Application Notes for more information.
3. Lumen maintenance and lifetime predictions are valid for drive current and case temperature conditions used for LM-80 testing as included in the applicable LM-80 test report. Contact your Bridgelux sales representatives for the LM-80 report.
4. Maximum Drive Current is maximum combined drive currents between both 2700K and 5000K/6500K channels. For example, if 1800mA is applied to the 2700K channel, no current may be applied to the 6500K channel of the array. If 900mA is applied to the 2700K channel, then a maximum of 900mA can be applied to the 6500K channel.
5. Bridgelux recommends a maximum duty cycle of 10% and pulse width of 20ms when operating LED arrays at the maximum peak pulsed current specified. Maximum peak pulsed currents indicate values where the LED array can be driven without catastrophic failures.

# Performance Curves

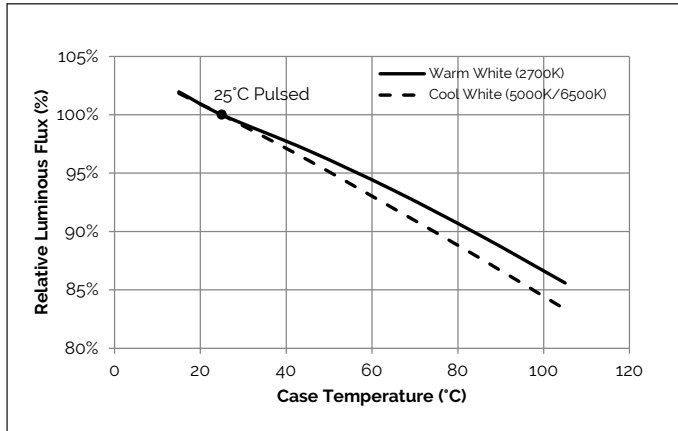
**Figure 1: Forward Voltage vs. Forward Current,  $T_c = 25^\circ\text{C}$**



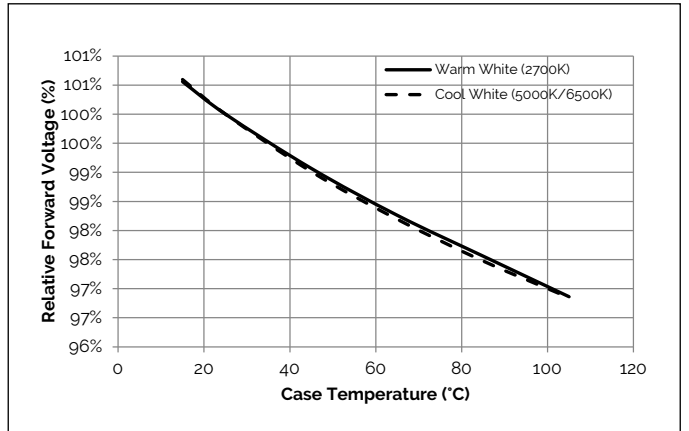
**Figure 2: Relative Flux vs. Drive Current,  $T_c = 25^\circ\text{C}$**



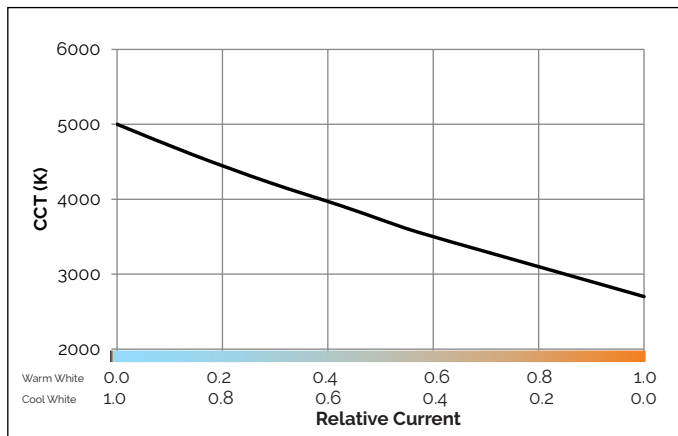
**Figure 3: Relative Flux vs. Case Temperature**



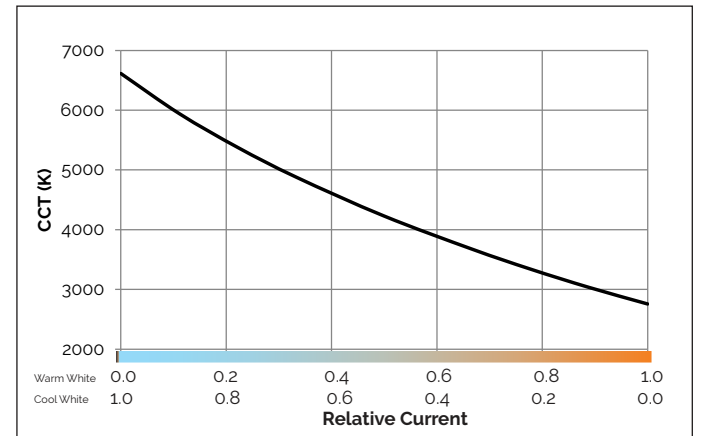
**Figure 4: Relative Voltage vs. Case Temperature**



**Figure 5: CCT vs. Relative Warm White Current**



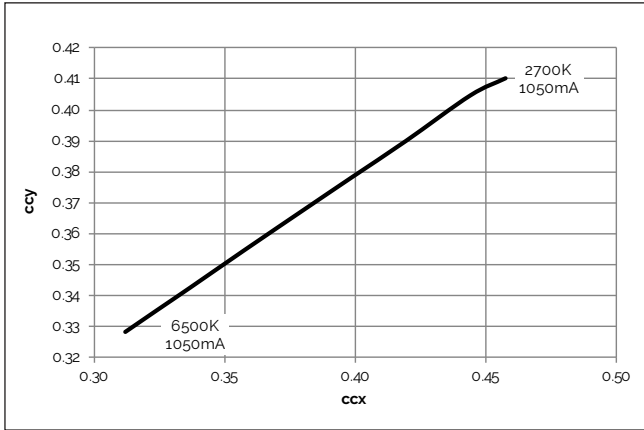
**Figure 6: CCT vs. Relative Warm White Current**



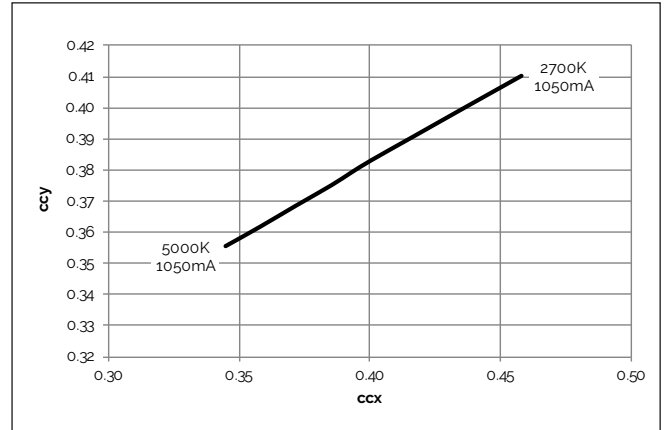


# Performance Curves

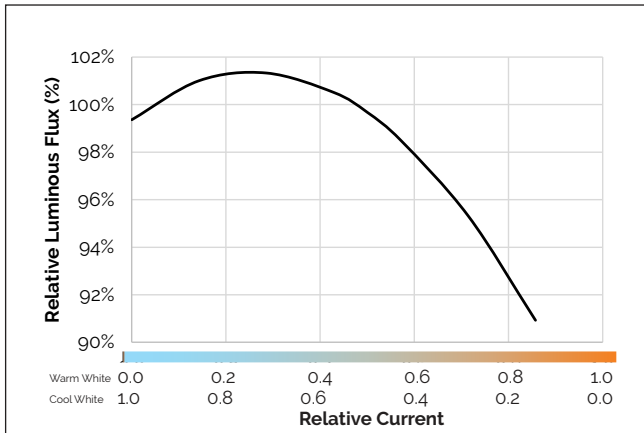
**Figure 7: CCT Tuning Range**



**Figure 8: CCT Tuning Range**

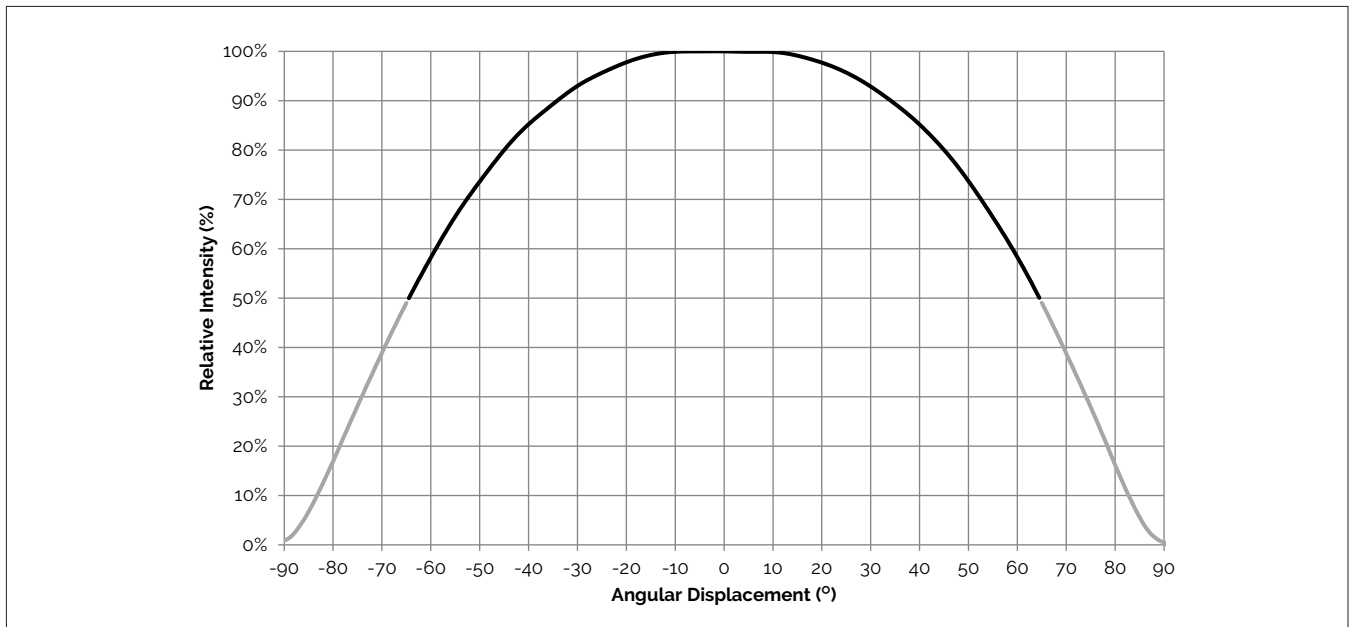


**Figure 9: Relative Flux vs. Relative Current**



# Typical Radiation Pattern

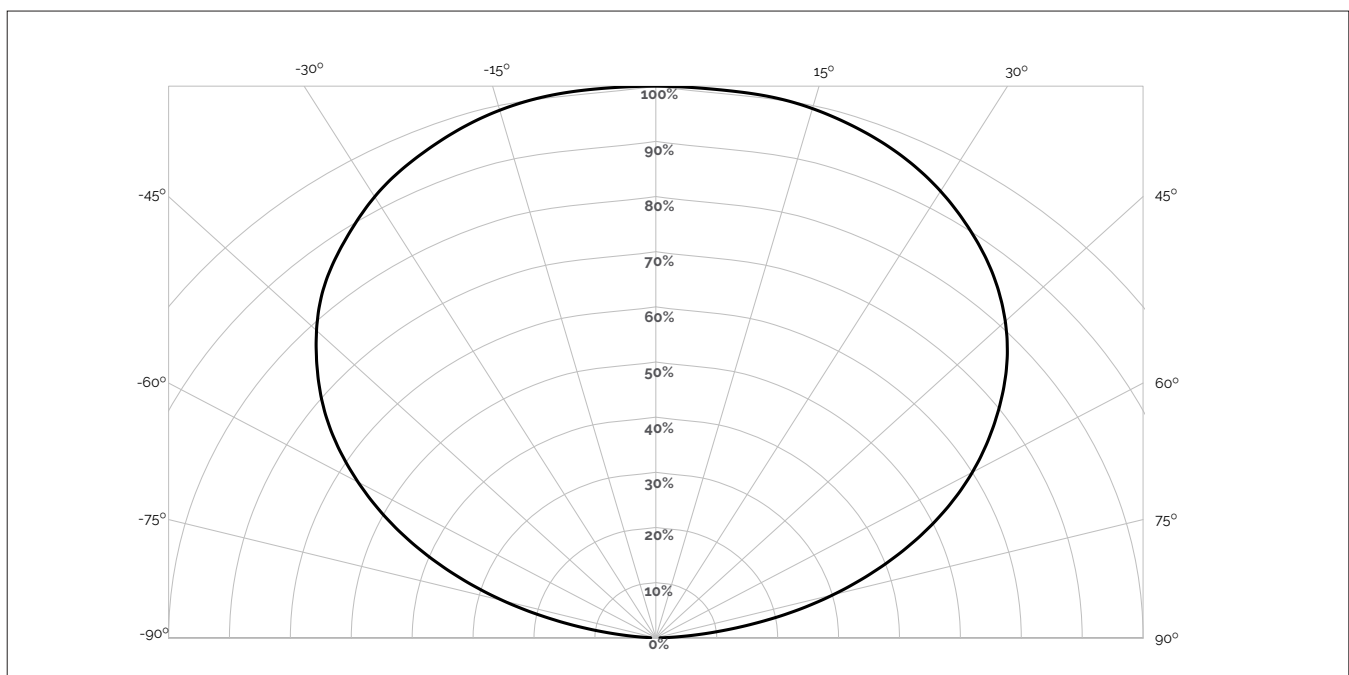
**Figure 10: Typical Spatial Radiation Pattern**



Notes for Figure 10:

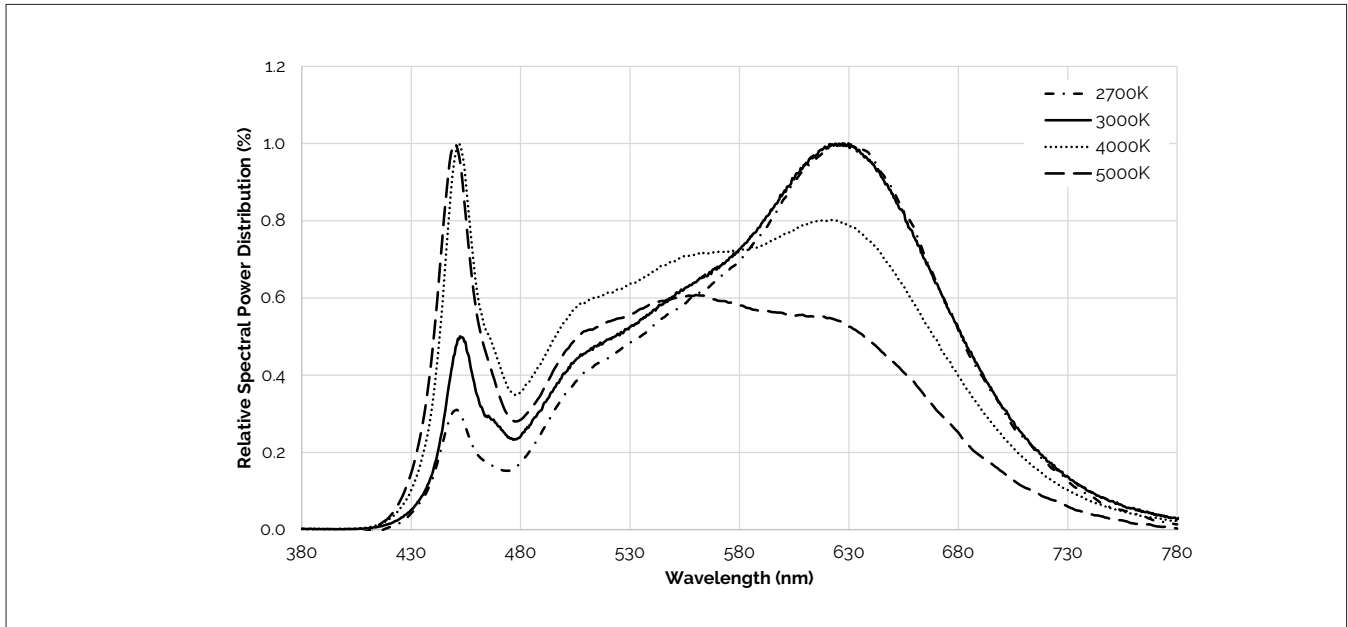
1. Typical viewing angle is 130°.
2. The viewing angle is defined as the off axis angle from the centerline where  $I_v$  is  $\frac{1}{2}$  of the peak value.

**Figure 11: Typical Polar Radiation Pattern**



# Typical Color Spectrum

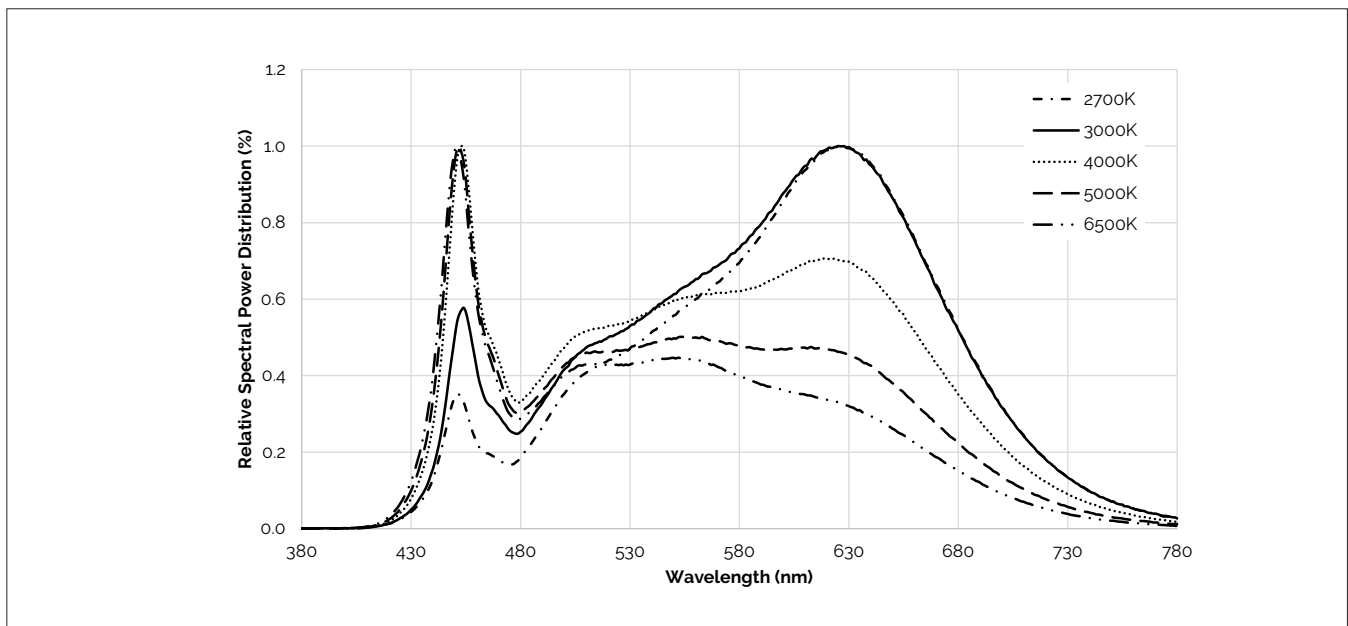
Figure 12: Typical Color Spectrum



Note for Figure 12:

1. Color spectra measured at nominal current for  $T_j = T_c = 25^\circ\text{C}$ .

Figure 13: Typical Color Spectrum

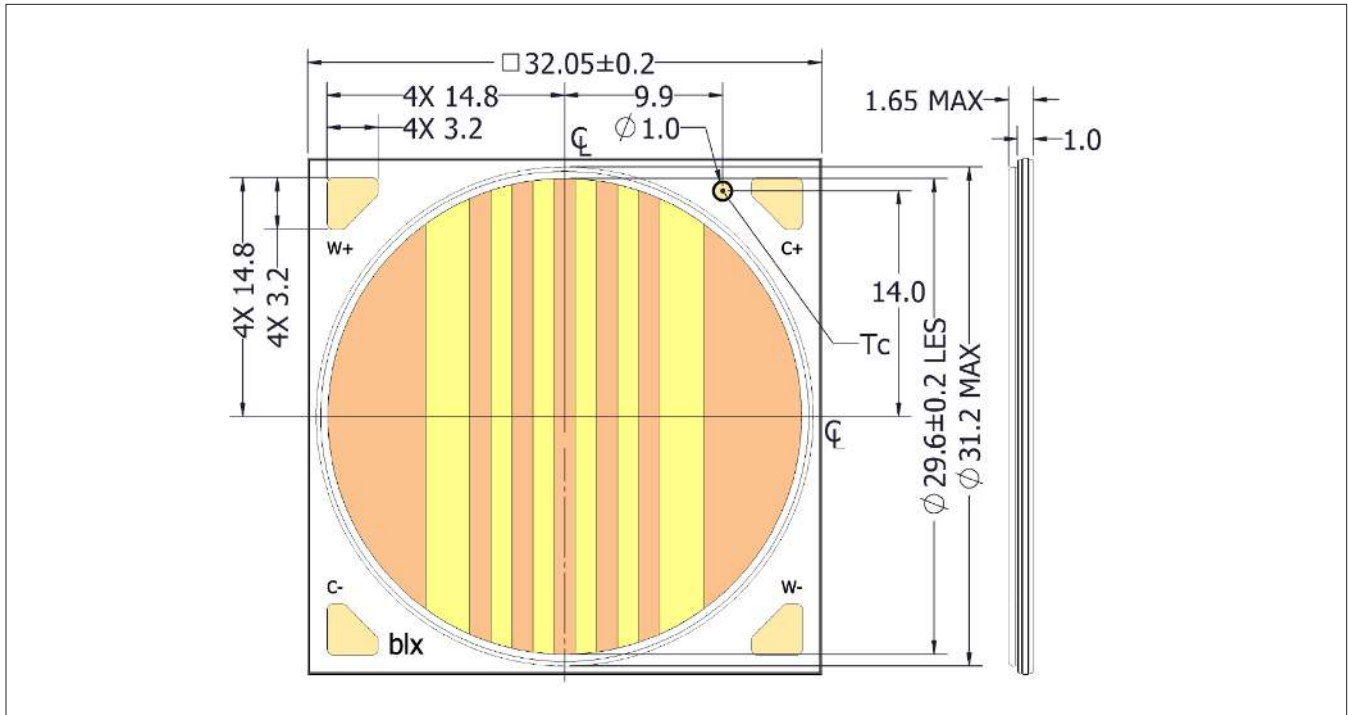


Note for Figure 13:

1. Color spectra measured at nominal current for  $T_j = T_c = 25^\circ\text{C}$ .

# Mechanical Dimensions

**Figure 14: Drawing for Vesta Series Tunable White Gen 2 29mm Array**

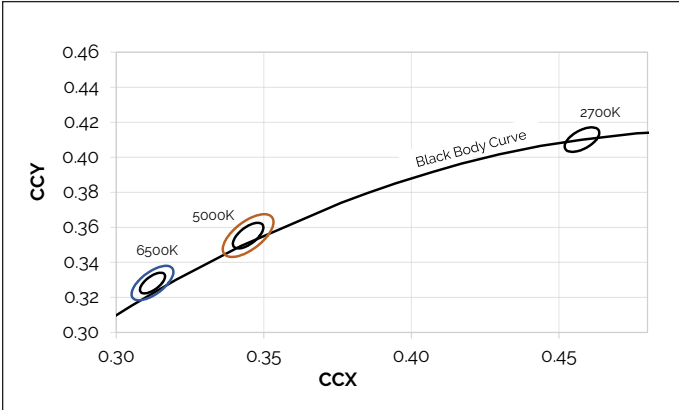


Notes for Figure 14:

1. Solder pads are labeled "+" to denote positive polarity and "-" to denote negative polarity. Solder pads have a gold surface finish.
2. Drawings are not to scale.
3. Drawing dimensions are in millimeters.
4. Unless otherwise specified, tolerances are  $\pm 0.10\text{mm}$ .
5. The optical center of the LED array is nominally defined by the mechanical center of the array.
6. Bridgelux maintains a flatness of 0.1 mm across the mounting surface of the array. Refer to Application Notes for product handling, mounting and heat sink recommendations.

# Color Binning Information

**Figure 15: Graph of Test Bins in xy Color Space**



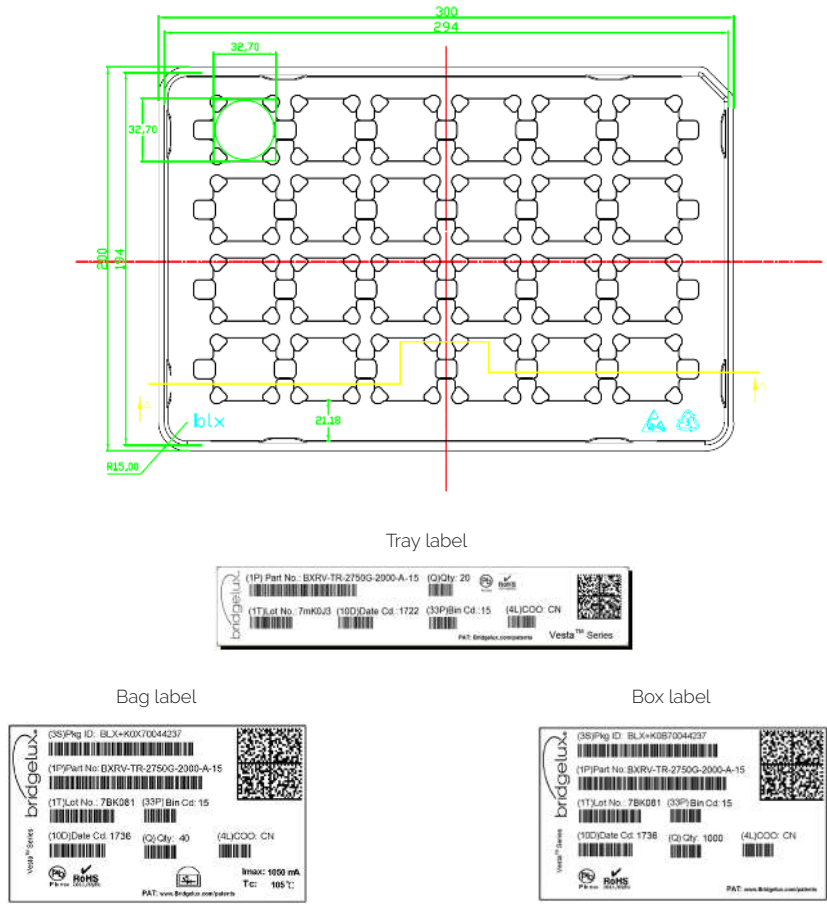
**Table 4: Bin Coordinates and Associated Typical CCT**

Bin Code	2700K	5000K	6500K
5 (5SDCM)	-	(4744K - 5347K)	(6122K - 7012K)
3 (3SDCM)	(2651K - 2794K)	(4853K - 5214K)	(6278K - 6810K)
Center Point (x,y)	(0.4578, 0.4101)	(0.3447, 0.3553)	(0.3123, 0.3282)

Note: Center Point (x,y)\* are the center points of the respective ANSI bins. Products are binned at Tc=85°C

# Packaging and Labeling

**Figure 16: Vesta Series Tunable White 29mm Packaging and Labeling**



Notes for Figure 16:

1. Each tray holds 24 Vesta Series Tunable White 29mm arrays.
2. Eight trays are sealed in an anti-static bag. Up to five such bags are placed in a box and shipped. Depending on quantities ordered, a bigger shipping box, containing four boxes will be used to ship products.
3. Each bag and box is to be labeled as shown above.
4. Dimensions for each tray are 300 mm (L) x 200 mm (W) x 8.8 mm (H). Dimensions for the anti-static bag are 440.0 mm (W) x 350.00 mm (L) x 0.1 mm (T) and that of the inner box are 350.00 mm (L) x 245.00 mm (W) x 6.7 mm (H).

# Design Resources

## Application Notes

Vesta Series Tunable White arrays are intended for use in dry, indoor applications. Bridgelux has developed a comprehensive set of application notes and design resources to assist customers in successfully designing with the Vesta Series product family of LED array products. For a list of resources under development, visit [www.bridgelux.com](http://www.bridgelux.com).

## Optical Source Models

Optical source models and ray set files are available for all Bridgelux products. For a list of available formats, visit [www.bridgelux.com](http://www.bridgelux.com).

## 3D CAD Models

Three dimensional CAD models depicting the product outline of all Bridgelux Vesta Series LED arrays are available in both IGS and STEP formats. Please contact your Bridgelux sales representative for assistance.

## LM80

Please contact your Bridgelux sales representative for more information.

# Precautions

## CAUTION: CHEMICAL EXPOSURE HAZARD

Exposure to some chemicals commonly used in luminaire manufacturing and assembly can cause damage to the LED array. Please consult Bridgelux Application Note for additional information.

## CAUTION: EYE SAFETY

Eye safety classification for the use of Bridgelux Vesta Series is ongoing. Please use appropriate precautions. It is important that employees working with LEDs are trained to use them safely. Please contact your Bridgelux sales representative for more information.

## CAUTION: RISK OF BURN

Do not touch the Vesta Series LED array during operation. Allow the array to cool for a sufficient period of time before handling. The Vesta Series LED array may reach elevated temperatures such that could burn skin when touched.

## CAUTION

### CONTACT WITH LIGHT EMITTING SURFACE (LES)

Avoid any contact with the LES. Do not touch the LES of the LED array or apply stress to the LES (yellow phosphor resin area). Contact may cause damage to the LED array.

Optics and reflectors must not be mounted in contact with the LES (yellow phosphor resin area). Optical devices may be mounted on the top surface of the Vesta Series LED array. Use the mechanical features of the LED array housing, edges and/or mounting holes to locate and secure optical devices as needed.

# Disclaimers

## STANDARD TEST CONDITIONS

Unless otherwise stated, array testing is performed at the nominal drive current.

## MINOR PRODUCT CHANGE POLICY

The rigorous qualification testing on products offered by Bridgelux provides performance assurance. Slight cosmetic changes that do not affect form, fit, or function may occur as Bridgelux continues product optimization.

# About Bridgelux: Bridging Light and Life™

At Bridgelux, we help companies, industries and people experience the power and possibility of light. Since 2002, we've designed LED solutions that are high performing, energy efficient, cost effective and easy to integrate. Our focus is on light's impact on human behavior, delivering products that create better environments, experiences and returns—both experiential and financial. And our patented technology drives new platforms for commercial and industrial luminaires.

**For more information about the company, please visit**

**[bridgelux.com](http://bridgelux.com)**

**[twitter.com/Bridgelux](https://twitter.com/Bridgelux)**

**[facebook.com/Bridgelux](https://facebook.com/Bridgelux)**

**[youtube.com/user/Bridgelux](https://youtube.com/user/Bridgelux)**

**[linkedin.com/company/bridgelux-inc-\\_2](https://linkedin.com/company/bridgelux-inc-_2)**

**WeChat ID: BridgeluxInChina**



46430 Fremont Blvd  
Fremont, CA 94538 USA  
Tel (925) 583-8400  
**[www.bridgelux.com](http://www.bridgelux.com)**

©2019 Bridgelux, Inc. All rights reserved 2019. Product specifications are subject to change without notice. Bridgelux, the Bridgelux stylized logo design and Vesta are registered trademarks of Bridgelux, Inc. Bridging Light and Life is a trademark of Bridgelux, Inc. All other trademarks are the property of their respective owners.

**Bridgelux Vesta Series Tunable White Gen 2 29mm Array Product Data Sheet DS355 Rev. A (06/2019)**