

**Customer Part:**



**Description**

- Surface mount oscillator in a ceramic package with a hermetically sealed metal lid
- Model CFPS-32
- Model Issue number 13

**Frequency Parameters**

- Frequency 25.0MHz
- Frequency Stability ±50.00ppm
- Operating Temperature Range -40.00 to 85.00°C

**Electrical Parameters**

- Supply Voltage 2.5V ±5%
- Current Draw 8.000mA

**Output Details**

- Output Compatibility CMOS
- Drive Capability 15pF max
- Rise and Fall Time 5.0ns max
- Duty Cycle 40/60%

**Output Control**

- Logic '1' (>70% VS) to pad 1 enables oscillator output  
Logic '0' (<30% VS) to pad 1 disables oscillator output; the oscillator output goes to the high impedance state  
No connection to pad 1 enables oscillator output
- Standby Current: 10µA max

**Environmental Parameters**

- Storage Temperature Range: -55 to 125°C
- Shock: MIL-STD-202, Method 213, Condition E
- Vibration: MIL-STD-883, Method 2007, Condition A

**Manufacturing Details**

- RoHS Terminations NiAu
- RoHS Reflow Temp 260degC 10s

**Compliance**

- RoHS Status (2015/863/EU) Compliant
- REACH Status Compliant
- MSL Rating (JEDEC-STD-033): Not Applicable

**Packaging Details**

- Pack Style: Bulk Loose in bulk pack
- Pack Size: 100
- *Alternative packing option available*



**Outline (mm)**

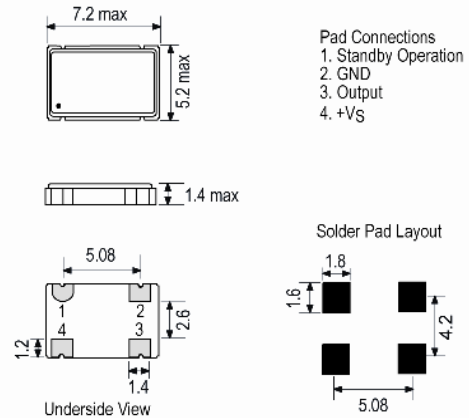

**Test Circuit**

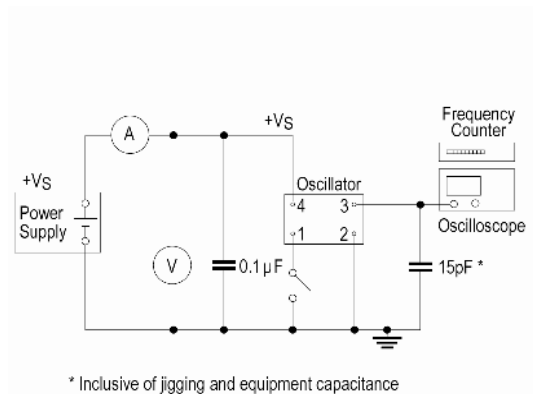

**Sales Office Contact Details:**

UK: +44 (0)1460 270200

USA: +1.760 668 8935

Email: [info@iqdfrequencyproducts.com](mailto:info@iqdfrequencyproducts.com)

Web: [www.iqdfrequencyproducts.com](http://www.iqdfrequencyproducts.com)

Customer Part:

Wave Form



---

**Sales Office Contact Details:**

UK: +44 (0)1460 270200

USA: +1.760 668 8935

Email: [info@iqdfrequencyproducts.com](mailto:info@iqdfrequencyproducts.com)

Web: [www.iqdfrequencyproducts.com](http://www.iqdfrequencyproducts.com)