

Wideband Microwave Amplifier

ZX60-183-S+

50Ω 6 to 18 GHz

The Big Deal

- Wideband, 6-18 GHz
- High Gain, Very Flat Response, 24 dB \pm 1.0 dB typ.
- Excellent Isolation, 62 dB typ.
- Unconditionally Stable performance



CASE STYLE: GC957

Product Overview

The ZX60-183-S+ two-stage amplifier provides high gain in a very small package, only 0.75" x 0.74" x 0.46" high. Internal compensating circuitry provides a consistent, very flat response over the full bandwidth. Designed for 50 Ω SMA coax systems, the gold-plated package uses convenient 5V DC power, and has a nickel-plated brass cover and unibody construction for rugged use.

Key Features

Feature	Advantages
Wideband, 6-18 GHz	Wide frequency range supports a wide array of applications, from microwave radio and radar to military communications, satellite communications, and countermeasures
Excellent Gain Flatness	\pm 1.0 dB gain flatness across entire bandwidth minimizes the need for external equalizer networks, making it a great fit for instrumentation, test lab, EW, or any other amplitude-sensitive system
High Gain and Excellent Isolation	24 dB gain with reverse isolation of 62 dB (38 dB directivity) prevents leakage, making the ZX60-183-S+ an excellent choice for minimizing interactions between different microwave components. It is an ideal LO driver amplifier and provides designers system flexibility and robustness when integrating cascaded RF components
Unconditionally Stable	No risk of damage to other components from impedance mismatch or internal oscillation

Notes

- A. Performance and quality attributes and conditions not expressly stated in this specification document are intended to be excluded and do not form a part of this specification document.
 B. Electrical specifications and performance data contained in this specification document are based on Mini-Circuit's applicable established test performance criteria and measurement instructions.
 C. The parts covered by this specification document are subject to Mini-Circuits standard limited warranty and terms and conditions (collectively, "Standard Terms"); Purchasers of this part are entitled to the rights and benefits contained therein. For a full statement of the Standard Terms and the exclusive rights and remedies thereunder, please visit Mini-Circuits' website at www.minicircuits.com/MCLStore/terms.jsp

Coaxial

Wideband Microwave Amplifier

ZX60-183-S+

50Ω 6 to 18 GHz

Features

- wideband, 6 to 18 GHz
- gain, 24 dB typ and flatness, ±1.0 dB typ.
- output power at 1 dB compression, 18.0 dBm typ.
- excellent isolation, 62 dB typ.
- unconditionally stable
- protected by US patent 6,790,049

Applications

- military and radar
- DBS
- wideband isolation amplifier
- microwave point to point radio
- satellite systems



CASE STYLE: GC957

Connectors	Model
SMA	ZX60-183-S+

+RoHS Compliant

The +Suffix identifies RoHS Compliance. See our web site for RoHS Compliance methodologies and qualifications

Electrical Specifications at 25°C

Parameter	Condition (GHz)	Min.	Typ.	Max.	Units
Frequency Range		6.0		18.0	GHz
Gain	6.0		24.2		dB
	8.0	18.5	24.3	—	
	10.0	18.5	23.5	—	
	12.0		23.5		
	14.0		23.4		
	16.0		22.7		
	18.0	18.5	24.0	—	
Gain Flatness	6.0-18.0		±1.0		dB
Input Return Loss	6.0		16.3		dB
	8.0	10.0	16.5	—	
	10.0		12.2		
	12.0	10.0	15.7	—	
	14.0		11.0		
	16.0		11.8		
	18.0		11.0		
Output Return Loss	6.0		22.2		dB
	8.0	10.0	17.2	—	
	10.0		13.8		
	12.0	10.0	15.9	—	
	14.0	10.0	22.8	—	
	16.0		15.0		
	18.0	10.0	26.6	—	
Output IP3	6.0		27.4		dBm
	8.0		27.7		
	10.0		27.9		
	12.0		27.2		
	14.0		26.9		
	16.0		27.1		
	18.0		26.4		
Output Power @ 1 dB compression	6.0		18.0		dBm
	8.0		18.3		
	10.0	16.0	18.5	—	
	12.0		18.1		
	14.0		17.6		
	16.0		18.0		
	18.0		18.0		
Noise Figure	6.0		8.2		dB
	8.0		6.9		
	10.0		6.3		
	12.0		6.9		
	14.0		6.8		
	16.0		6.8		
	18.0		6.5		
Directivity (Isolation-Gain)			38		dB
DC Voltage			5.0		V
DC Current			260	290	mA

Notes

- Performance and quality attributes and conditions not expressly stated in this specification document are intended to be excluded and do not form a part of this specification document.
- Electrical specifications and performance data contained in this specification document are based on Mini-Circuit's applicable established test performance criteria and measurement instructions.
- The parts covered by this specification document are subject to Mini-Circuits standard limited warranty and terms and conditions (collectively, "Standard Terms"); Purchasers of this part are entitled to the rights and benefits contained therein. For a full statement of the Standard Terms and the exclusive rights and remedies thereunder, please visit Mini-Circuits' website at www.minicircuits.com/MCLStore/terms.jsp



Maximum Ratings

Parameter	Ratings
Operating Temperature	-40°C to 85°C Base Plate Temp.
Storage Temperature	-55°C to 100°C
DC Voltage	5.5V
Input RF Power (no damage)	+20 dBm
Power Dissipation	1.6 W

Permanent damage may occur if any of these limits are exceeded.

Outline Drawing

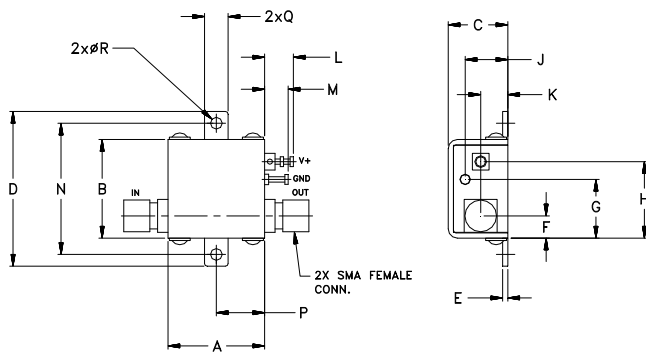

NOTE: When soldering the DC connections, caution must be used to avoid overheating the DC terminal. See Application Note. [AN-40-010](#).

Outline Dimensions (inch/mm)

A	B	C	D	E	F	G	H	J	K	L	M	N	P	Q	R	wt
.74	.75	.46	1.18	.04	.17	.45	.59	.33	.21	.22	.18	1.00	.37	.18	.106	grams
18.80	19.05	11.68	29.97	1.02	4.32	11.43	14.99	8.38	5.33	5.59	4.57	25.40	9.40	4.57	2.69	23.0

Notes

- Performance and quality attributes and conditions not expressly stated in this specification document are intended to be excluded and do not form a part of this specification document.
- Electrical specifications and performance data contained in this specification document are based on Mini-Circuit's applicable established test performance criteria and measurement instructions.
- The parts covered by this specification document are subject to Mini-Circuits standard limited warranty and terms and conditions (collectively, "Standard Terms"); Purchasers of this part are entitled to the rights and benefits contained therein. For a full statement of the Standard Terms and the exclusive rights and remedies thereunder, please visit Mini-Circuits' website at www.minicircuits.com/MCLStore/terms.jsp



FREQUENCY (MHz)	GAIN (dB)	DIRECTIVITY	VSWR IN (:1)	VSWR OUT (:1)	POWER OUT @ 1 dB COMPR. (dBm)	IP3 (dBm)	NF (dB)
6000.00	24.24	43.74	1.13	1.23	17.80	27.78	7.40
7000.00	24.13	41.84	1.06	1.31	18.44	27.98	7.03
8000.00	24.19	38.28	1.26	1.47	18.49	27.72	6.90
9000.00	23.91	36.50	1.57	1.62	18.73	27.47	7.08
10000.00	23.19	39.89	1.67	1.64	18.63	27.76	6.37
11000.00	23.09	45.13	1.64	1.56	18.43	27.26	7.21
12000.00	23.23	40.13	1.41	1.36	18.13	27.49	7.01
13000.00	23.36	40.96	1.21	1.15	17.90	27.48	6.89
14000.00	23.22	38.51	1.32	1.20	17.34	27.34	6.82
15000.00	22.74	38.10	1.57	1.48	17.28	27.48	6.90
16000.00	22.47	39.63	1.59	1.63	17.84	27.64	6.77
17000.00	23.02	44.13	1.39	1.51	17.47	27.12	7.56
18000.00	23.73	39.26	1.43	1.20	18.24	26.71	6.59

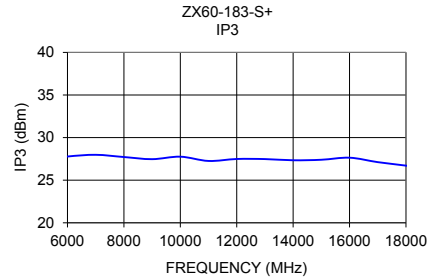
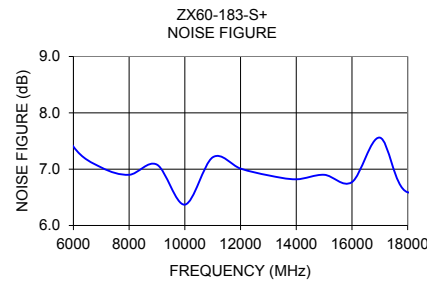
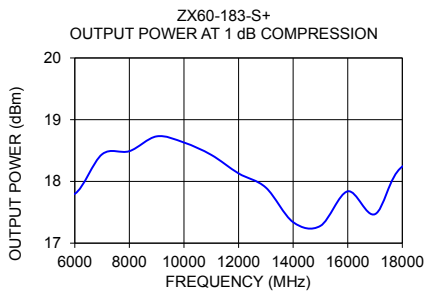
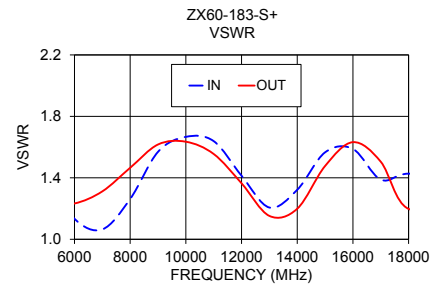
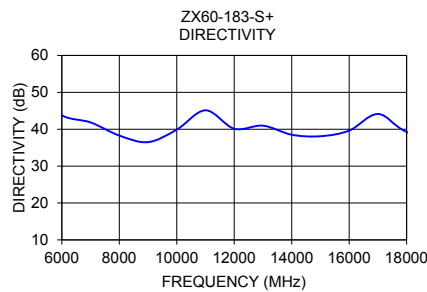
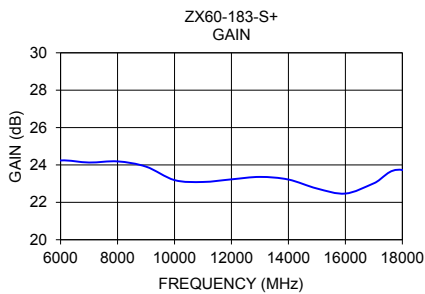

Notes

- A. Performance and quality attributes and conditions not expressly stated in this specification document are intended to be excluded and do not form a part of this specification document.
- B. Electrical specifications and performance data contained in this specification document are based on Mini-Circuit's applicable established test performance criteria and measurement instructions.
- C. The parts covered by this specification document are subject to Mini-Circuits standard limited warranty and terms and conditions (collectively, "Standard Terms"); Purchasers of this part are entitled to the rights and benefits contained therein. For a full statement of the Standard Terms and the exclusive rights and remedies thereunder, please visit Mini-Circuits' website at www.minicircuits.com/MCLStore/terms.jsp

