



Connectors > Connector Accessories > Connector Strain Relief > Crimp Barrel for D-Sub Connectors



Strain Relief Accessory Type: **Crimp Barrel**

Shielded: **Yes**

Thread Size: **None**

Operating Temperature Range: **-40 – 90 °C [-40 – 194 °F]**

[All Crimp Barrel for D-Sub Connectors \(22\)](#)

Features

Product Type Features

Strain Relief Accessory Type	Crimp Barrel
------------------------------	--------------

Mechanical Attachment

Thread Size	None
-------------	------

Usage Conditions

Operating Temperature Range	-40 – 90 °C [-40 – 194 °F]
-----------------------------	------------------------------

Operation/Application

Shielded	Yes
----------	-----

Product Compliance

[For compliance documentation, visit the product page on TE.com>](#)

EU RoHS Directive 2011/65/EU	Compliant with Exemptions
EU ELV Directive 2000/53/EC	Compliant with Exemptions
China RoHS 2 Directive MIIT Order No 32, 2016	Restricted Materials Above Threshold
EU REACH Regulation (EC) No. 1907/2006	



Current ECHA Candidate List: JUNE 2023 (235)

Candidate List Declared Against: JUNE 2023 (235)

SVHC > Threshold:

Pb (3.5% in Component Part)

Article Safe Usage Statements:

Do not eat, drink or smoke when using this product. Wash thoroughly after handling. Recycle if possible and dispose of the article by following all applicable governmental regulations relevant to your geographic location.

Halogen Content

Low Halogen - Br, Cl, F, I < 900 ppm per homogenous material. Also BFR/CFR/PVC Free

Solder Process Capability

Not reviewed for solder process capability

Product Compliance Disclaimer

This information is provided based on reasonable inquiry of our suppliers and represents our current actual knowledge based on the information they provided. This information is subject to change. The part numbers that TE has identified as EU RoHS compliant have a maximum concentration of 0.1% by weight in homogenous materials for lead, hexavalent chromium, mercury, PBB, PBDE, DBP, BBP, DEHP, DIBP, and 0.01% for cadmium, or qualify for an exemption to these limits as defined in the Annexes of Directive 2011/65/EU (RoHS2). Finished electrical and electronic equipment products will be CE marked as required by Directive 2011/65/EU. Components may not be CE marked. Additionally, the part numbers that TE has identified as EU ELV compliant have a maximum concentration of 0.1% by weight in homogenous materials for lead, hexavalent chromium, and mercury, and 0.01% for cadmium, or qualify for an exemption to these limits as defined in the Annexes of Directive 2000/53/EC (ELV). Regarding the REACH Regulation, the information TE provides on SVHC in articles for this part number is based on the latest European Chemicals Agency (ECHA) 'Guidance on requirements for substances in articles' posted at this URL: <https://echa.europa.eu/guidance-documents/guidance-on-reach>

Compatible Parts



TE Part # CAT-R131-F614A
Crimp Flange for Size 4-5 STD/5QL Shell



TE Part # 1-2308349-3
CRIMP FLANGE 3 SMALL



TE Part # 3-2823558-3
CRIMP INSERTS (BARREL ID 12.0 X OD 13.0)

Also in the Series | Rail D-Sub Backshells



Connector Backshells(69)



Connector Strain Relief(53)



Crimp D-Sub Connectors(10)

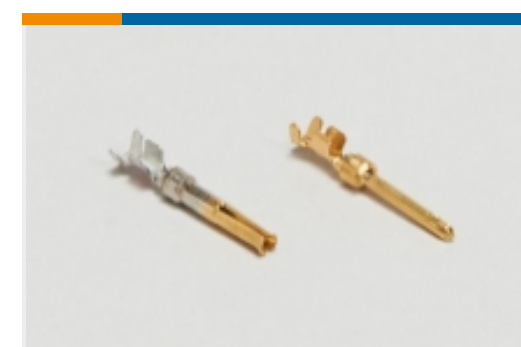

D-Sub Connector Contacts(5)



Insertion & Extraction Tools(2)

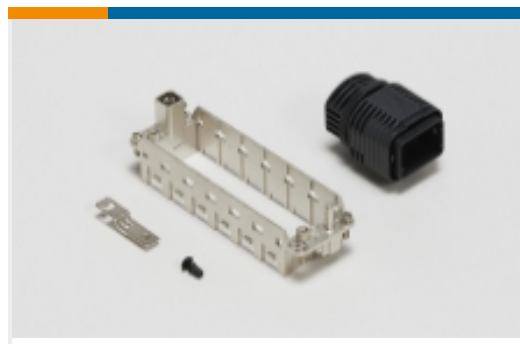

Rectangular Connector Hardware(19)

Customers Also Bought



TE Part #1-2308349-1
CRIMP FLANGES SMALL



TE Part #1-2308350-3
Crimp Barrel for D-Sub Connectors



TE Part #2-2308348-0
CRIMP FLANGE 10 LARGE

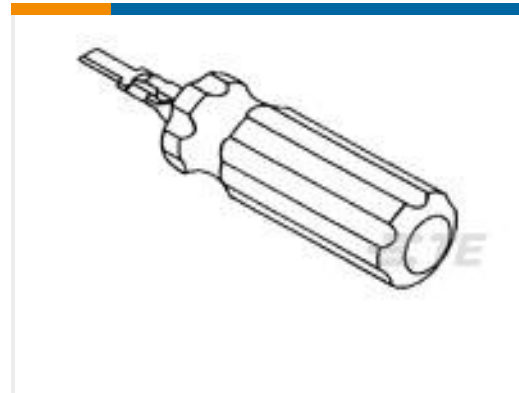

TE Part #724659-1
EXT TOOL FOR POSITIVE .187

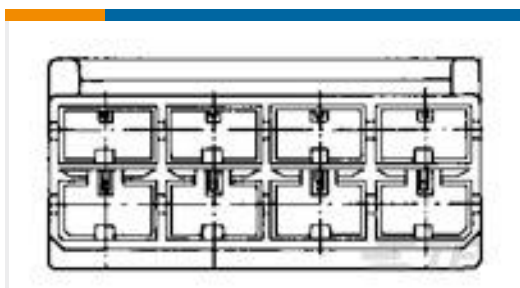

TE Part #926646-1
PL 250 REC HSG 8P NYLON BLACK

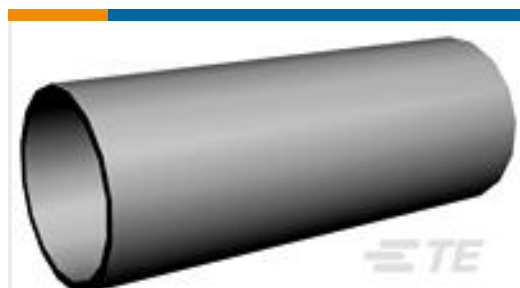

TE Part #3-745130-8
SHLDING FERRULE,PLTD,BULK PKG



TE Part #NB20274001
VERSAFIT-3/16-0-SP

Documents

Product Drawings

[CRIMP BARREL16](#)

English

CAD Files

[3D PDF](#)

3D

Customer View Model

[ENG_CVM_CVM_2-2308350-6_A.2d_dxf.zip](#)

English

Customer View Model

[ENG_CVM_CVM_2-2308350-6_A.3d_igs.zip](#)

English

Customer View Model

[ENG_CVM_CVM_2-2308350-6_A.3d_stp.zip](#)

English

By downloading the CAD file I accept and agree to the [Terms and Conditions](#) of use.



[Datasheets & Catalog Pages](#)

[Rail D-Sub Backshells Flyer](#)

English