

REV.	Change NO.	Change Description	Date	Approved
A0		NEW	2018.01.31	

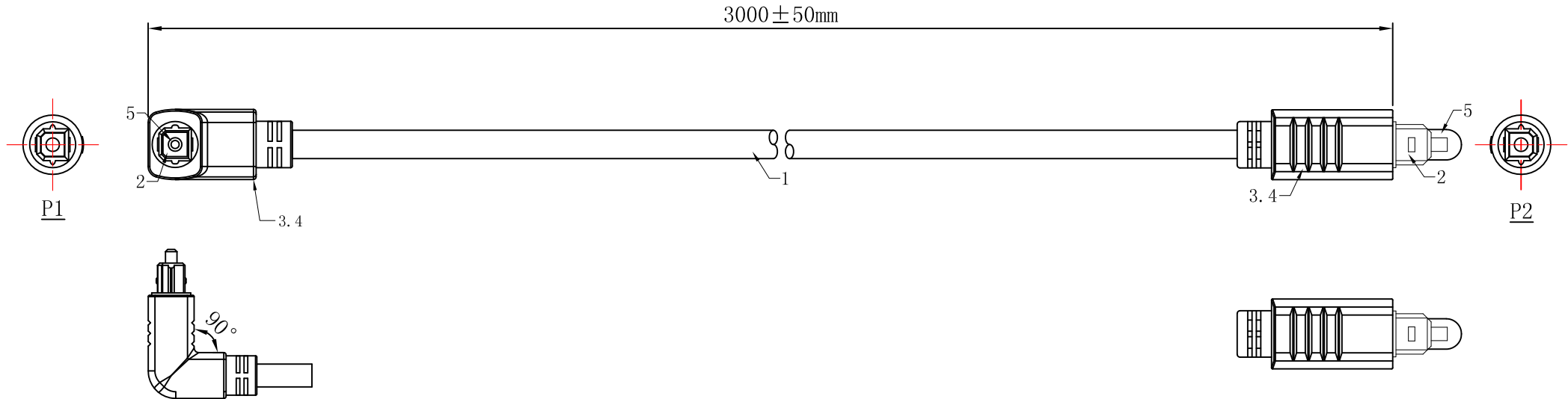

OPTO M MOLDING TYPE
 INNER MOLD NO. :HJ-CT-444
 OUTER MOLD NO. :HJ-CT-434

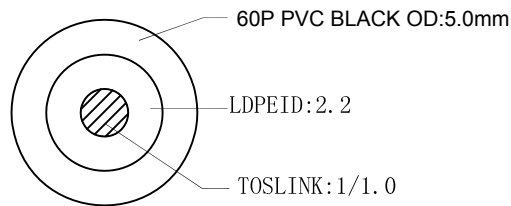

29ZZ00040BK001 (HJ-0143)

OPTO M MOLDING TYPE
 OUTER MOLD NO. :HJ-CT-416

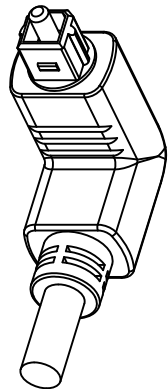

ITEM NO.	106-1242-BL-00300-5	Customer			
DESCRIPTION		REV.	A0	FILE/N	
MATERIAL NO.	C-OPTOM-M-3.0M	PAGE	1 OF 1	APPRO	
CnC Tech, LLC		UNIT	mm	CHECK	
		SCALE	NONE	DRAWN	Shel
		PROJECTION		DATE:	2018.01.31