

Rail-to-rail high output current quad operational amplifiers with standby mode and adjustable phantom ground

Features

- Rail-to-rail input and output
- Low noise: 9 nV/√Hz
- Low distortion
- High output current: 80 mA (able to drive 32 Ω loads)
- High-speed: 4 MHz, 1.3 V/μs
- Operating range from 2.7 to 12 V
- Low input offset voltage: 900 μV max. (TS925A)
- Adjustable phantom ground ($V_{CC}/2$)
- Standby mode
- ESD internal protection: 2 kV
- Latch-up immunity

Applications

- Headphone amplifiers
- Soundcard amplifiers, piezoelectric speakers
- MPEG boards, multimedia systems
- Cordless telephones and portable communication equipment
- Line drivers, buffers
- Instrumentation with low noise as key factor

Description

The TS925 is a rail-to-rail quad BiCMOS operational amplifier optimized and fully specified for 3- and 5-V operation.

High output current allows low load impedances to be driven. An internal low impedance phantom ground eliminates the need for an external reference voltage or biasing arrangement.

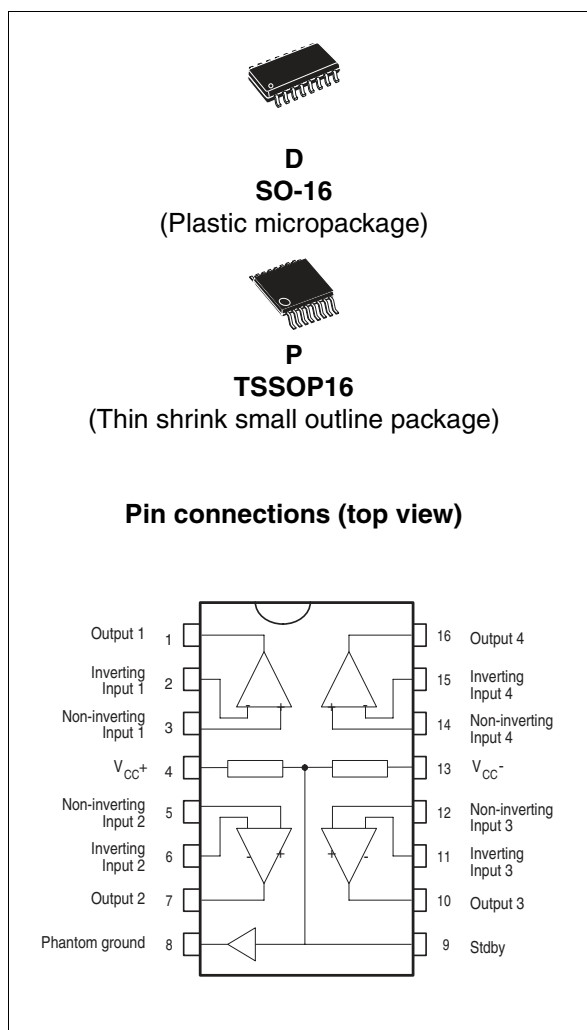

The TS925 exhibits very low noise, low distortion and high output current, making this device an excellent choice for high-quality, low-voltage or battery-operated audio/telecom systems.

The device is stable for capacitive loads up to 500 pF. When the STANDBY mode is enabled, the total consumption drops to 6 μA ($V_{CC} = 3 V$).

1 Absolute maximum ratings and operating conditions

Table 1. Absolute maximum ratings

Symbol	Parameter	Conditions	Value	Unit
V _{CC}	Supply voltage ⁽¹⁾		14	V
V _{id}	Differential input voltage ⁽²⁾		±1	V
V _i	Input voltage		V _{DD} -0.3 to V _{CC} +0.3	V
T _j	Maximum junction temperature		150	°C
R _{thja}	Thermal resistance junction to ambient	SO-16 TSSOP16	95 95	°C/W
R _{thjc}	Thermal resistance junction to case	SO-16 TSSOP16	30 25	°C/W
ESD	Electrostatic discharge	HBM Human body model ⁽³⁾	2	kV
		MM Machine model ⁽⁴⁾	200	V
		CDM Charged device model	1	kV
	Output short circuit duration		See note ⁽⁵⁾	
	Latch-up immunity		200	mA
	Soldering temperature	10 sec, Pb-free package	260	°C

1. All voltage values, except differential voltage are with respect to network ground terminal.
2. Differential voltages are the non-inverting input terminal with respect to the inverting input terminal. If V_{id} > ±1 V, the maximum input current must not exceed ±1mA. In this case (V_{id} > ±1V), an input series resistor must be added to limit input current.
3. Human body model: 100pF discharged through a 1.5 kΩ resistor into pin of device.
4. Machine model ESD: a 200 pF cap is charged to the specified voltage, then discharged directly into the IC with no external series resistor (internal resistor < 5 Ω), into pin-to-pin of device.
5. There is no short-circuit protection inside the device: short-circuits from the output to V_{CC} can cause excessive heating. The maximum output current is approximately 80 mA, independent of the magnitude of V_{CC}. Destructive dissipation can result from simultaneous short-circuits on all amplifiers.

Table 2. Operating conditions

Symbol	Parameter	Value	Unit
V _{CC}	Supply voltage	2.7 to 12	V
V _{icm}	Common mode input voltage range	V _{DD} -0.2 to V _{CC} +0.2	V
T _{oper}	Operating free air temperature range	-40 to +125	°C

2 Electrical characteristics

Table 3. Electrical characteristics for $V_{CC} = 3\text{ V}$ with $V_{DD} = 0\text{ V}$, $V_{icm} = V_{CC}/2$, R_L connected to $V_{CC}/2$, $T_{amb} = 25^\circ\text{ C}$ (unless otherwise specified)

Symbol	Parameter	Conditions	Min.	Typ.	Max.	Unit
DC performance						
V_{io}	Input offset voltage	At $T_{amb} = +25^\circ\text{C}$ TS925 TS925A At $T_{min.} \leq T_{amb} \leq T_{max.}$: TS925 TS925A			3 0.9 5 1.8	mV
DV_{io}	Input offset voltage drift			2		$\mu\text{V}/^\circ\text{C}$
I_{io}	Input offset current	$V_{out} = 1.5\text{V}$		1	30	nA
I_{ib}	Input bias current	$V_{out} = 2.5\text{V}$		15	100	nA
CMR	Common mode rejection ratio	V_{icm} from 0 to 3 V $T_{min} \leq T_{amb} \leq T_{max}$	60	80		dB
V_{OH}	High level output voltage	$R_L = 10\text{k}\Omega$ $R_L = 600\Omega$ $R_L = 32\Omega$	2.90 2.87	2.63		V
V_{OL}	Low level output voltage	$R_L = 10\text{k}\Omega$ $R_L = 600\Omega$ $R_L = 32\Omega$		180	50 100	mV
A_{vd}	Large signal voltage gain	$V_{out} = 2V_{pk-pk}$ $R_L = 10\text{k}\Omega$ $R_L = 600\Omega$ $R_L = 32\Omega$		200 35 16		V/mV
SVR	Supply voltage rejection ratio	$V_{cc} = 2.7$ to 3.3V	60	85		dB
I_o	Output short-circuit current		50	80		mA
I_{CC}	Total supply current	No load, $V_{out} = V_{cc}/2$		5	7	mA
I_{stby}	Total supply current in STANDBY	Pin 9 connected to V_{cc-}		6		μA
V_{enstby}	Pin 9 voltage to enable the STANDBY mode ⁽¹⁾	at $T_{amb} = +25^\circ\text{C}$ at $T_{min} \leq T_{amb} \leq T_{max}$			0.3 0.4	V
V_{distby}	Pin 9 voltage to disable the STANDBY mode ⁽¹⁾	at $T_{amb} = +25^\circ\text{C}$ at $T_{min} \leq T_{amb} \leq T_{max}$	1.1 1			V
AC performance						
GBP	Gain bandwidth product	$R_L = 600\Omega$		4		MHz
SR	Slew rate		0.7	1.3		$\text{V}/\mu\text{s}$
Pm	Phase margin at unit gain	$R_L = 600\Omega$, $C_L = 100\text{pF}$		68		Degrees

Table 3. Electrical characteristics for $V_{CC} = 3\text{ V}$ with $V_{DD} = 0\text{ V}$, $V_{icm} = V_{CC}/2$, R_L connected to $V_{CC}/2$, $T_{amb} = 25^\circ\text{ C}$ (unless otherwise specified) (continued)

Symbol	Parameter	Conditions	Min.	Typ.	Max.	Unit
GM	Gain margin	$R_L = 600\Omega$, $C_L = 100\text{pF}$		12		dB
e_n	Equivalent input noise voltage	$f = 1\text{kHz}$		9		$\frac{\text{nV}}{\sqrt{\text{Hz}}}$
THD	Total harmonic distortion	$V_{out} = 2V_{pk-pk}$, $f = 1\text{kHz}$, $A_v = 1$, $R_L = 600\Omega$		0.01		%
C_s	Channel separation			120		dB
Phantom ground						
V_{pg}	Phantom ground output voltage	No output current	$V_{CC}/2$ -5%	$V_{CC}/2$	$V_{CC}/2$ +5%	V
I_{pgsc}	Phantom ground output short circuit current - sourced		12	18		mA
Z_{pg}	Phantom ground impedance	DC to 20kHz		3		Ω
E_{npg}	Phantom ground output voltage noise	$f = 1\text{kHz}$ $C_{dec} = 100\text{pF}$ $C_{dec} = 1\text{nF}$ $C_{dec} = 10\text{nF}^{(2)}$		200 40 17		$\frac{\text{nV}}{\sqrt{\text{Hz}}}$
I_{pgsk}	Phantom ground output short circuit current - sinked		12	18		mA

1. The STANDBY mode is enabled when pin 9 is GROUNDED and disabled when pin 9 is left OPEN.
2. C_{dec} is the decoupling capacitor on pin 9.

Table 4. Electrical characteristics for $V_{CC} = 5\text{ V}$, $V_{DD} = 0\text{ V}$, $V_{icm} = V_{CC}/2$, R_L connected to $V_{CC}/2$, $T_{amb} = 25^\circ\text{C}$ (unless otherwise specified)

Symbol	Parameter	Conditions	Min.	Typ.	Max.	Unit
DC performance						
V_{io}	Input offset voltage	At $T_{amb} = +25^\circ\text{C}$: TS925 TS925A At $T_{min.} \leq T_{amb} \leq T_{max.}$: TS925 TS925A			3 0.9 5 1.8	mV
DV_{io}	Input offset voltage drift			2		$\mu\text{V}/^\circ\text{C}$
I_{io}	Input offset current	$V_{out} = 2.5\text{V}$		1	30	nA
I_{ib}	Input bias current	$V_{out} = 2.5\text{V}$		15	100	nA
CMR	Common mode rejection ratio	V_{icm} from 0 to 5 V $T_{min} \leq T_{amb} \leq T_{max}$	60	80		dB
V_{OH}	High level output voltage	$R_L = 10\text{k}\Omega$ $R_L = 600\Omega$ $R_L = 32\Omega$	4.90 4.85	4.4		V
V_{OL}	Low level output voltage	$R_L = 10\text{k}\Omega$ $R_L = 600\Omega$ $R_L = 32\Omega$		300	50 120	mV
A_{vd}	Large signal voltage gain	$V_{out} = 2V_{pk-pk}$ $R_L = 10\text{k}$ $R_L = 600\Omega$ $R_L = 32\Omega$		200 40 17		V/mV
SVR	Supply voltage rejection ratio	$V_{cc} = 3$ to 5V	60	85		dB
I_o	Output short-circuit current		50	80		mA
I_{CC}	Total supply current	No load, $V_{out} = V_{cc}/2$		6	8	mA
I_{stby}	Total supply current in STANDBY	Pin 9 connected to V_{cc}		6		μA
V_{enstby}	Pin 9 Voltage to enable the STANDBY mode ⁽¹⁾	at $T_{amb} = +25^\circ\text{C}$ at $T_{min} \leq T_{amb} \leq T_{max}$			0.3 0.4	V
V_{distby}	Pin 9 voltage to disable the STANDBY mode ⁽¹⁾	at $T_{amb} = +25^\circ\text{C}$ at $T_{min} \leq T_{amb} \leq T_{max}$	1.1 1			V
AC performance						
GBP	Gain bandwidth product	$R_L = 600\Omega$		4		MHz
SR	Slew rate		0.7	1.3		V/ μs
Pm	Phase margin at unit gain	$R_L = 600\Omega$, $C_L = 100\text{pF}$		68		Degrees
GM	Gain margin	$R_L = 600\Omega$, $C_L = 100\text{pF}$		12		dB

Table 4. Electrical characteristics for $V_{CC} = 5\text{ V}$, $V_{DD} = 0\text{ V}$, $V_{icm} = V_{CC}/2$, R_L connected to $V_{CC}/2$, $T_{amb} = 25^\circ\text{ C}$ (unless otherwise specified) (continued)

Symbol	Parameter	Conditions	Min.	Typ.	Max.	Unit
e_n	Equivalent input noise voltage	$f = 1\text{ kHz}$		9		$\frac{\text{nV}}{\sqrt{\text{Hz}}}$
THD	Total harmonic distortion	$V_{out} = 2V_{pk-pk}$, $f = 1\text{ kHz}$, $A_v = 1$, $R_L = 600\Omega$		0.01		%
C_s	Channel separation			120		dB
Phantom ground						
V_{pg}	Phantom ground output voltage	No output current	$V_{cc}/2$ -5%	$V_{cc}/2$	$V_{cc}/2$ +5%	V
I_{pgsc}	Phantom ground output short circuit current - sourced		12	18		mA
Z_{pg}	Phantom ground impedance	DC to 20kHz		3		Ω
E_{npg}	Phantom ground output voltage noise	$f = 1\text{ kHz}$ $C_{dec} = 100\text{ pF}$ $C_{dec} = 1\text{ nF}$ $C_{dec} = 10\text{ nF}^{(2)}$		200 40 17		$\frac{\text{nV}}{\sqrt{\text{Hz}}}$
I_{pgsk}	Phantom ground output short circuit current - sinked		12	18		mA

1. The STANDBY mode is enabled when pin 9 is GROUNDED and disabled when pin 9 is left OPEN.
2. C_{dec} is the decoupling capacitor on pin 9.

Figure 1. Input offset voltage distribution

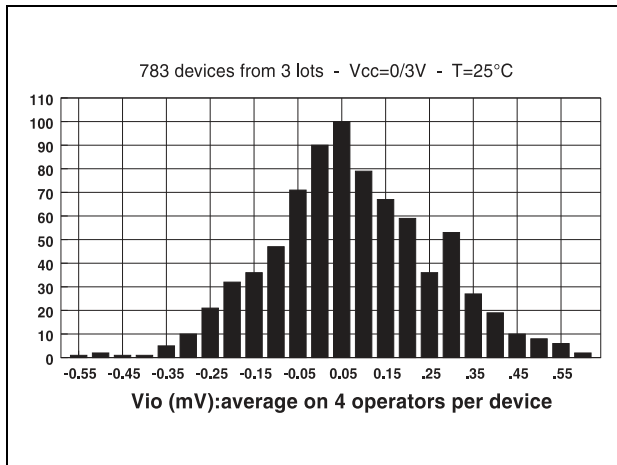

Figure 2. Total supply current vs. supply voltage with no load

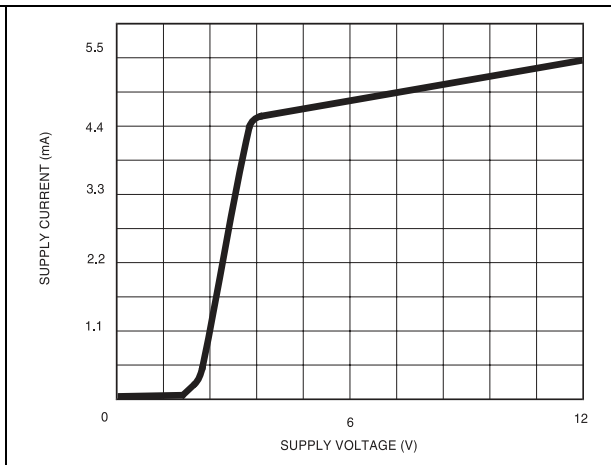

Figure 3. Supply current/amplifier vs. temperature

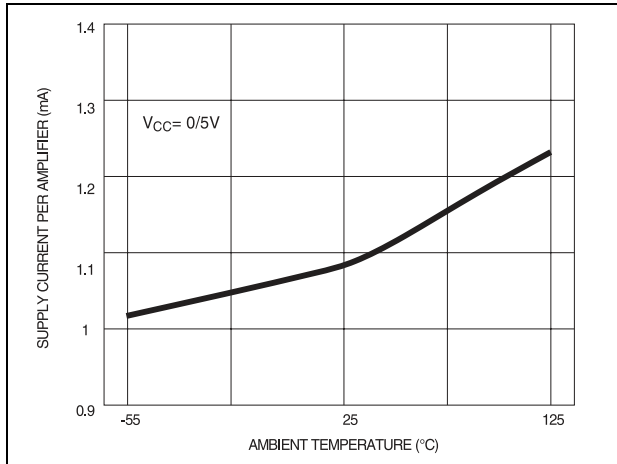

Figure 4. Output short circuit current vs. output voltage

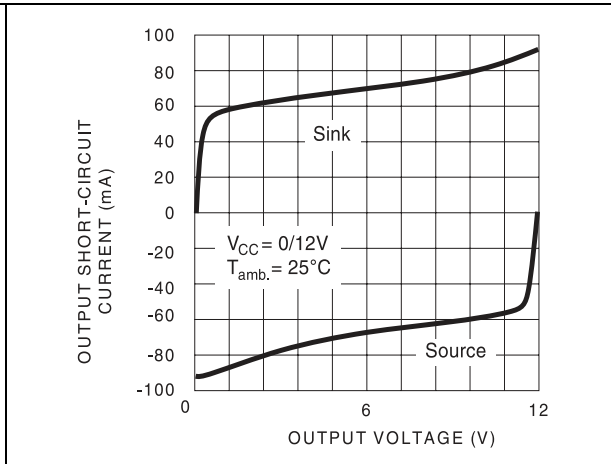

Figure 5. Output short circuit current vs. output voltage

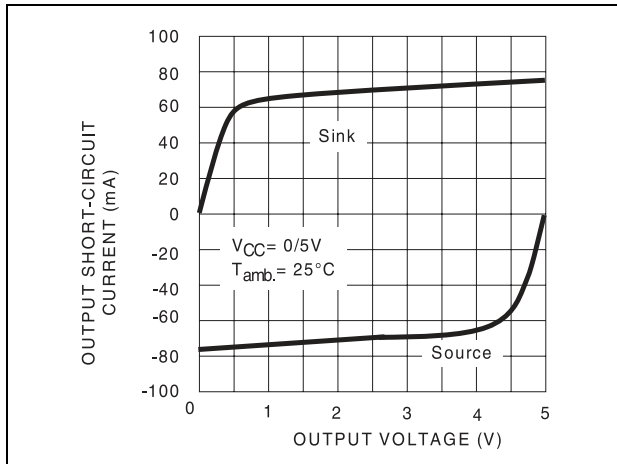

Figure 6. Output short circuit current vs. output voltage

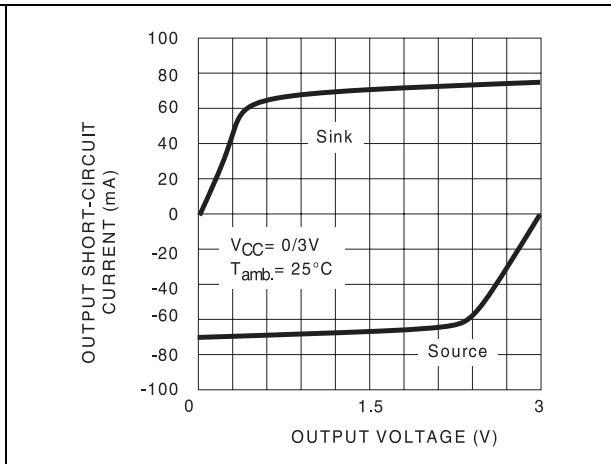

Figure 7. Output short circuit current vs. temperature

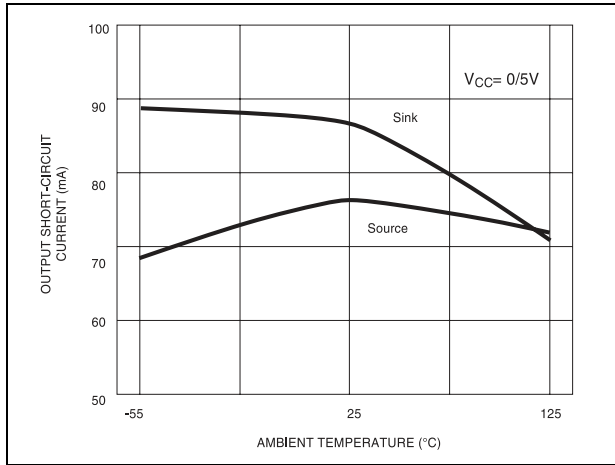

Figure 8. Voltage gain and phase vs. frequency

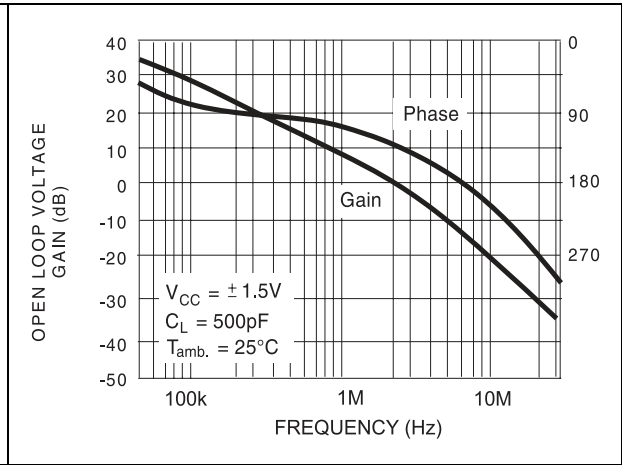

Figure 9. Distortion + noise vs. frequency

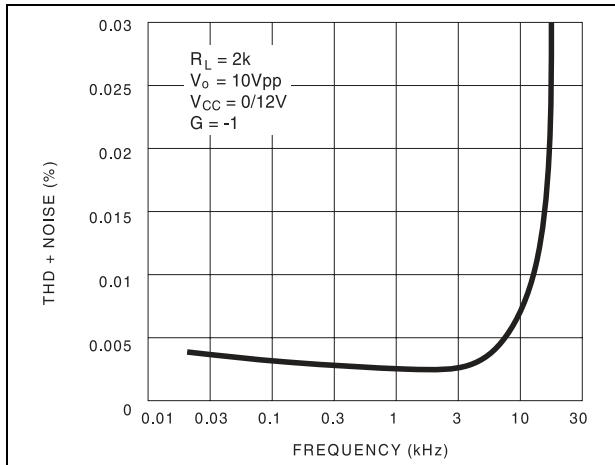

Figure 10. THD + noise vs. frequency

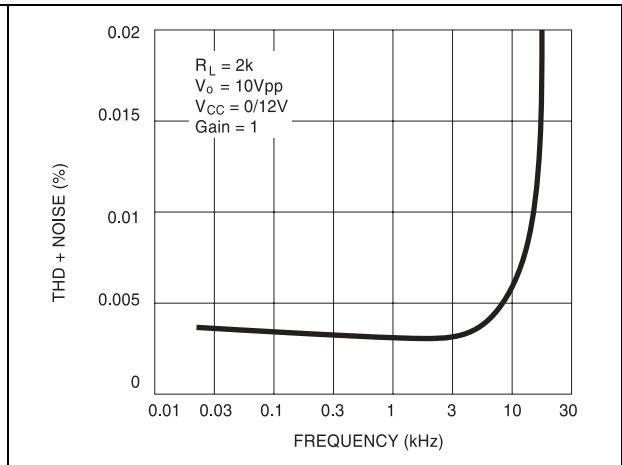

Figure 11. THD + noise vs. frequency

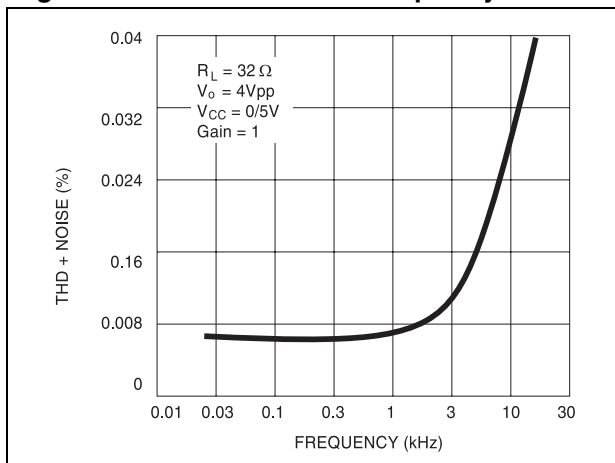

Figure 12. THD + noise vs. frequency

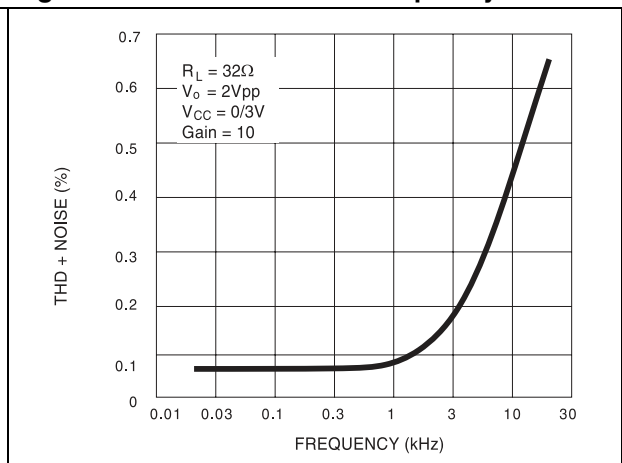

Figure 13. Equivalent input noise vs. frequency

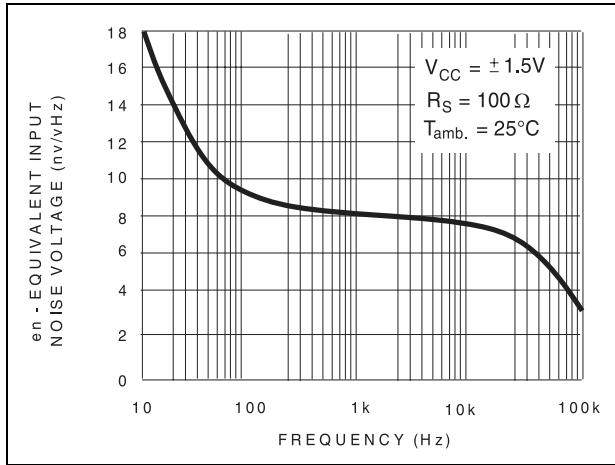

Figure 14. Total supply current vs. standby input voltage

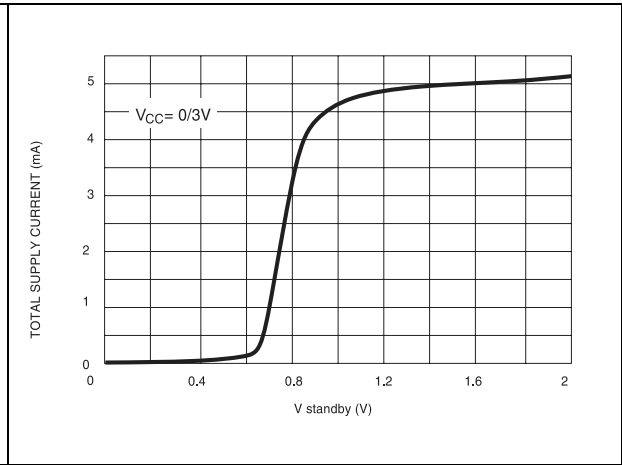
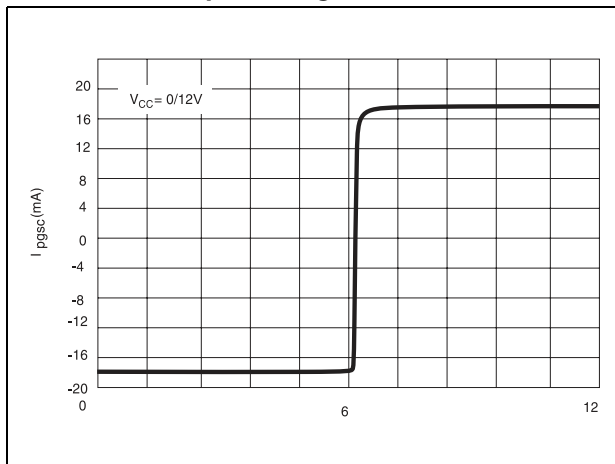

Figure 15. Phantom ground short circuit output current vs. phantom ground output voltage



3 Using the TS925 as a preamplifier and speaker driver

The TS925 is an input/output rail-to-rail quad BiCMOS operational amplifier. It can operate with low supply voltages (2.7 V) and drive output loads as low as 32 Ω

This section illustrates these features by providing an example of how the device can be used as a preamplifier and speaker driver.

The application circuit is shown in [Figure 16](#).

- Operators A1 and A4 are used in a preamplifier configuration.
- Operators A2 and A3 are used in a push-pull configuration driving a headset.
- The phantom ground is used as a common reference level ($V_{CC}/2$).
- The power supply is delivered by two LR6 batteries (2 x 1.5 V nominal).

Figure 16. Electrical schematic

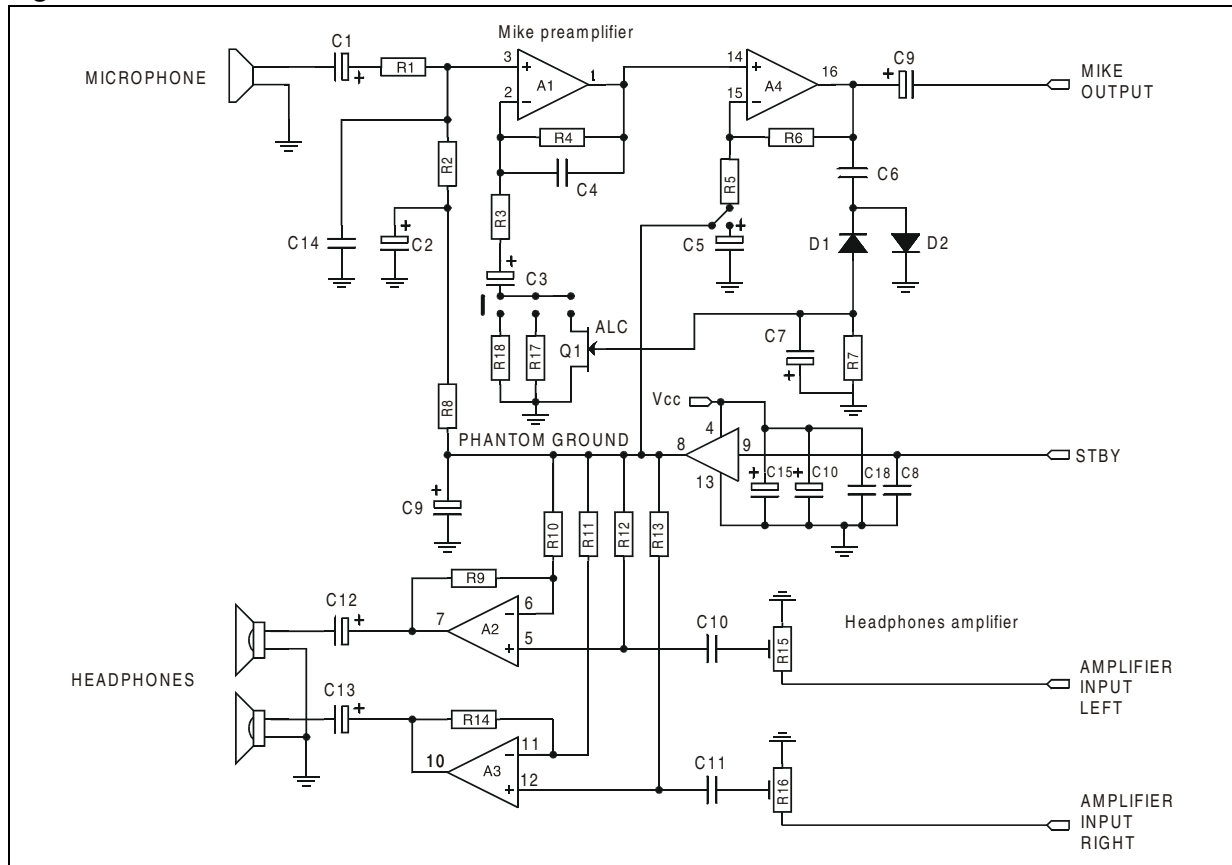

3.1 Preamplifier configuration

The operators A1 and A4 are wired with a non-inverting gain of respectively:

- A1# $(R4/(R3+R17))$
- A4# $R6/R5$

With the following values:

- $R4 = 22\text{ k}\Omega$ - $R3 = 50\ \Omega$ - $R17 = 1.2\text{ k}\Omega$
- $R6 = 47\text{ k}\Omega$ - $R5 = 1.2\text{ k}\Omega$

The gain of the preamplifier chain is therefore equal to 58 dB.

Alternatively, the gain of A1 can be adjusted by choosing a JFET transistor Q1 instead of R17. This JFET voltage controlled resistor arrangement forms an automatic level control (ALC) circuit, useful in many microphone preamplifier applications. The mean rectified peak level of the output signal envelope is used to control the preamplifier gain.

3.2 Headphone amplifier

The operators A2 and A3 are organized in a push-pull configuration with a gain of 5. The stereo inputs can be connected to a CD player and the TS925 can directly drive the headphone speakers. This configuration shows the ability of the circuit to drive a $32\ \Omega$ load with a maximum output swing and high fidelity suitable for sound and music.

Figure 19 shows the available signal swing at the headset outputs: two other rail-to-rail competitor parts are employed in the same circuit for comparison (note the much-reduced clipping level and crossover distortion).

Figure 17. Frequency response of the global preamplifier chain

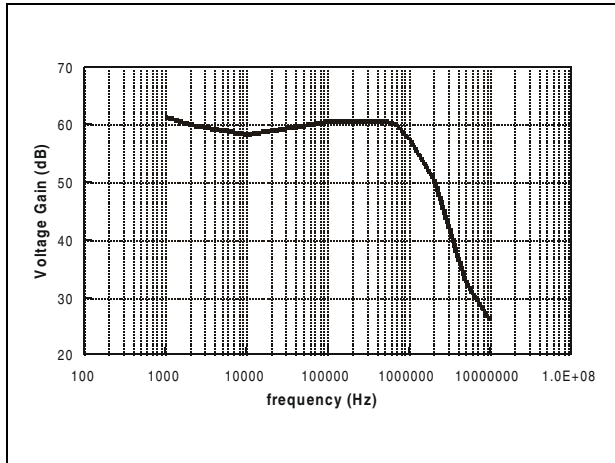

Figure 18. Voltage noise density vs. frequency at preamplifier output

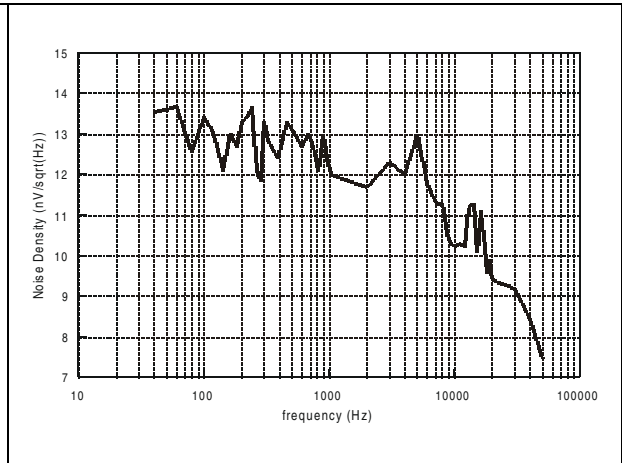

Figure 19. Maximum voltage swing at headphone outputs ($R_L = 32 \Omega$)

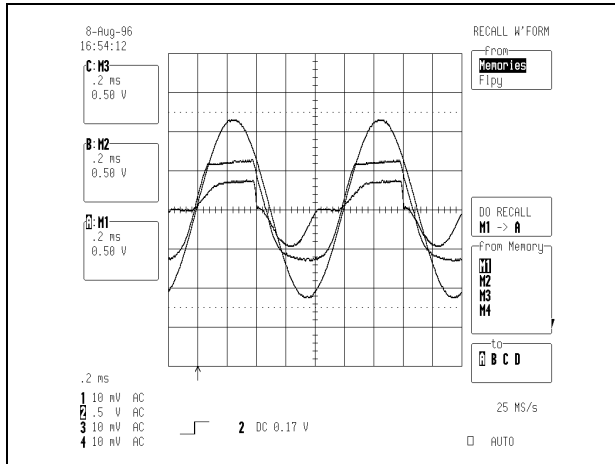
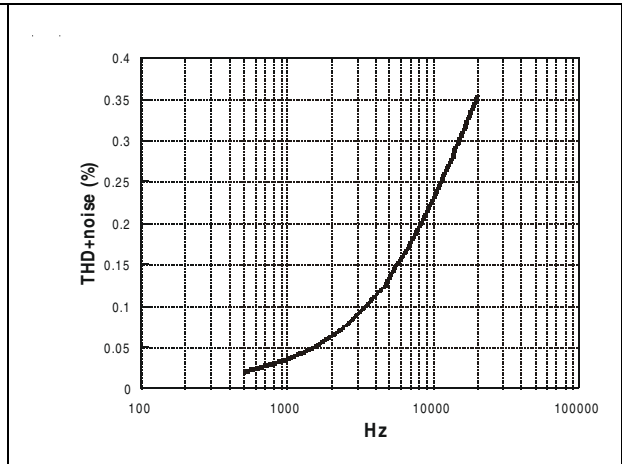

Figure 20. THD + noise vs. frequency (headphone outputs)



4 Package information

In order to meet environmental requirements, ST offers these devices in different grades of ECOPACK[®] packages, depending on their level of environmental compliance. ECOPACK[®] specifications, grade definitions and product status are available at: www.st.com. ECOPACK[®] is an ST trademark.

4.1 SO-16 package information

Figure 21. SO-16 package mechanical drawing

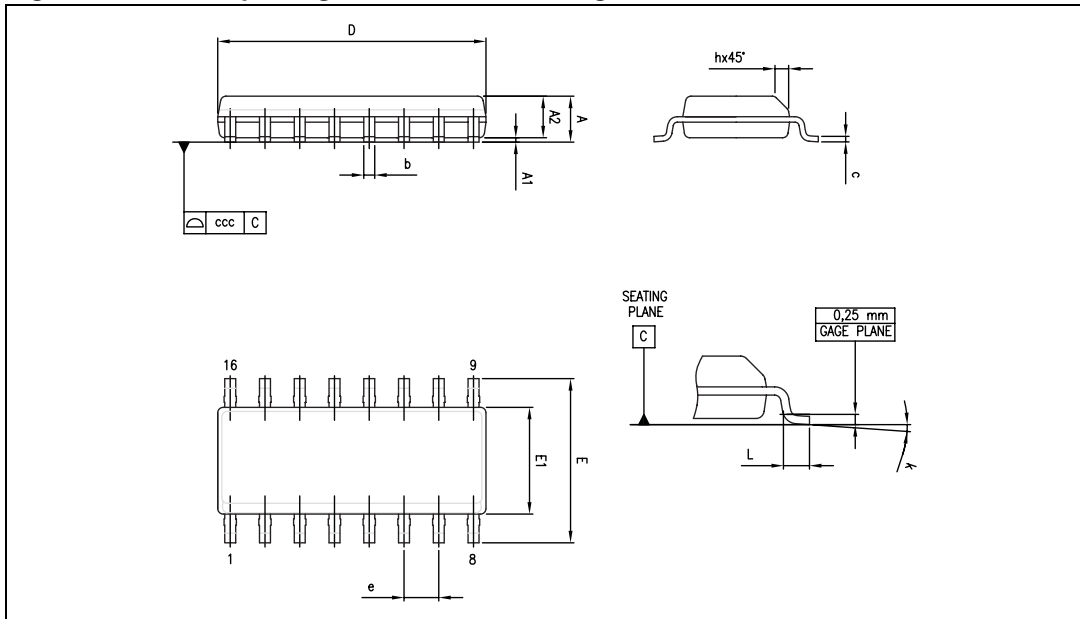

Table 5. SO-16 package mechanical data

Ref.	Dimensions					
	Millimeters			Inches		
	Min.	Typ.	Max.	Min.	Typ.	Max.
A			1.75			0.069
A1	0.10		0.25	0.004		0.010
A2	1.25			0.049		
b	0.31		0.51	0.012		0.020
c	0.17		0.25	0.007		0.010
D ⁽¹⁾	9.80	9.90	10.00	0.386	0.390	0.394
E	5.80	6.00	6.20	0.228	0.236	0.244
E1 ⁽²⁾	3.80	3.90	4.00	0.150	0.154	0.157
e		1.27			0.050	
h	0.25		0.50	0.010		0.020
L	0.40		1.27	0.016		0.050
k	0		8			
ccc			0.10			0.004

1. Does not include mold flash, protrusions or gate burrs. Mold flash, protrusions or gate burrs not to exceed 0.15 mm in total.
2. Does not include interlead flash or protrusions. Interlead flash or protrusions not to exceed 0.25 mm per side.

4.2 TSSOP16 package information

Figure 22. TSSOP16 package mechanical drawing

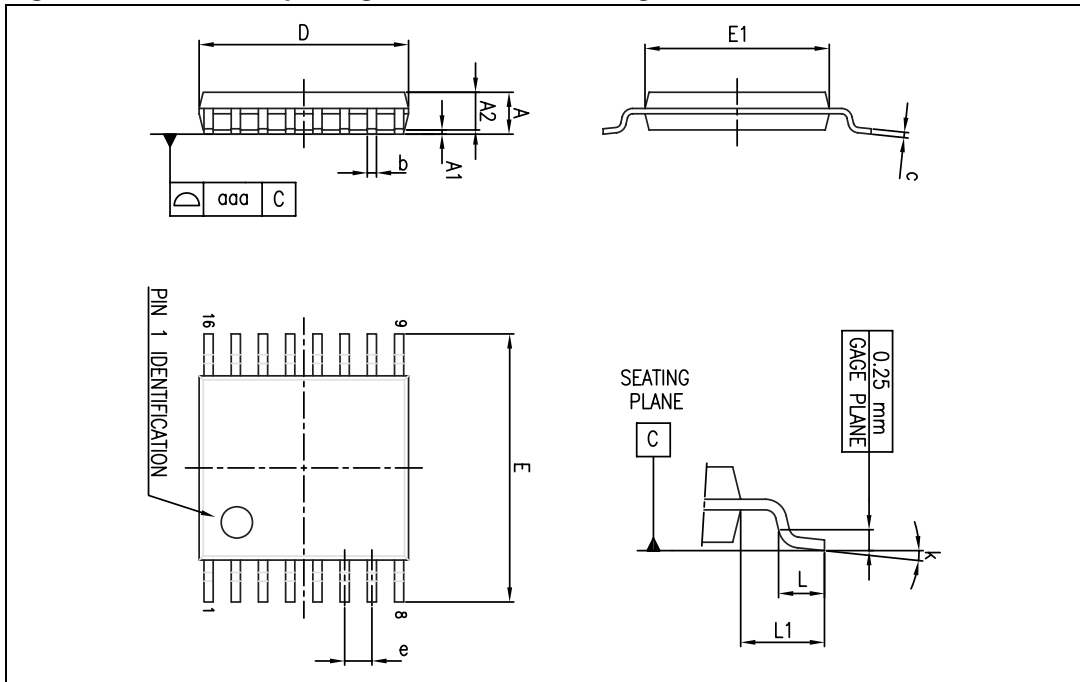

Table 6. TSSOP16 package mechanical data

Ref.	Dimensions					
	Millimeters			Inches		
	Min.	Typ.	Max.	Min.	Typ.	Max.
A			1.20			0.047
A1	0.05		0.15	0.002		0.006
A2	0.80	1.00	1.05	0.031	0.039	0.041
b	0.19		0.30	0.007		0.012
c	0.09		0.20	0.004		0.008
D	4.90	5.00	5.10	0.193	0.197	0.201
E	6.20	6.40	6.60	0.244	0.252	0.260
E1	4.30	4.40	4.50	0.169	0.173	0.177
e		0.65			0.0256	
k	0°		8°	0°		8°
L	0.45	0.60	0.75	0.018	0.024	0.030
L1		1.00			0.039	
aaa			0.10			0.004

5 Ordering information

Order code	Temperature range	Package	Packing	Marking
TS925ID/IDT	-40°C to +125°C	SO-16	Tube and tape & reel	925I
TS925IPT		TSSOP16	Tape & reel	
TS925AID/AIDT		SO-16	Tube and tape & reel	925AI
TS925AIPT		TSSOP16	Tape & reel	

6 Revision history

Table 7. Document revision history

Date	Revision	Changes
01-Feb-2001	1	Initial release. Product in full production.
01-Nov-2005	2	The following changes were made in this revision: <ul style="list-style-type: none"> – Chapter on Macromodels removed from the datasheet. – Data updated in Table 3. on page 3. – Data in tables in Electrical characteristics on page 3 reformatted for easier use. – Minor grammatical and formatting changes throughout.
10-Mar-2009	3	Document reformatted. Removed DIP package information in Chapter 4 and associated order codes in Chapter 5. Updated SO-16 and TSSOP16 package drawings and dimensions in Chapter 4.
28-Apr-2011	4	Modified CMR conditions in Table 3 and Table 4.

Please Read Carefully:

Information in this document is provided solely in connection with ST products. STMicroelectronics NV and its subsidiaries ("ST") reserve the right to make changes, corrections, modifications or improvements, to this document, and the products and services described herein at any time, without notice.

All ST products are sold pursuant to ST's terms and conditions of sale.

Purchasers are solely responsible for the choice, selection and use of the ST products and services described herein, and ST assumes no liability whatsoever relating to the choice, selection or use of the ST products and services described herein.

No license, express or implied, by estoppel or otherwise, to any intellectual property rights is granted under this document. If any part of this document refers to any third party products or services it shall not be deemed a license grant by ST for the use of such third party products or services, or any intellectual property contained therein or considered as a warranty covering the use in any manner whatsoever of such third party products or services or any intellectual property contained therein.

UNLESS OTHERWISE SET FORTH IN ST'S TERMS AND CONDITIONS OF SALE ST DISCLAIMS ANY EXPRESS OR IMPLIED WARRANTY WITH RESPECT TO THE USE AND/OR SALE OF ST PRODUCTS INCLUDING WITHOUT LIMITATION IMPLIED WARRANTIES OF MERCHANTABILITY, FITNESS FOR A PARTICULAR PURPOSE (AND THEIR EQUIVALENTS UNDER THE LAWS OF ANY JURISDICTION), OR INFRINGEMENT OF ANY PATENT, COPYRIGHT OR OTHER INTELLECTUAL PROPERTY RIGHT.

UNLESS EXPRESSLY APPROVED IN WRITING BY AN AUTHORIZED ST REPRESENTATIVE, ST PRODUCTS ARE NOT RECOMMENDED, AUTHORIZED OR WARRANTED FOR USE IN MILITARY, AIR CRAFT, SPACE, LIFE SAVING, OR LIFE SUSTAINING APPLICATIONS, NOR IN PRODUCTS OR SYSTEMS WHERE FAILURE OR MALFUNCTION MAY RESULT IN PERSONAL INJURY, DEATH, OR SEVERE PROPERTY OR ENVIRONMENTAL DAMAGE. ST PRODUCTS WHICH ARE NOT SPECIFIED AS "AUTOMOTIVE GRADE" MAY ONLY BE USED IN AUTOMOTIVE APPLICATIONS AT USER'S OWN RISK.

Resale of ST products with provisions different from the statements and/or technical features set forth in this document shall immediately void any warranty granted by ST for the ST product or service described herein and shall not create or extend in any manner whatsoever, any liability of ST.

ST and the ST logo are trademarks or registered trademarks of ST in various countries.

Information in this document supersedes and replaces all information previously supplied.

The ST logo is a registered trademark of STMicroelectronics. All other names are the property of their respective owners.

© 2011 STMicroelectronics - All rights reserved

STMicroelectronics group of companies

Australia - Belgium - Brazil - Canada - China - Czech Republic - Finland - France - Germany - Hong Kong - India - Israel - Italy - Japan - Malaysia - Malta - Morocco - Philippines - Singapore - Spain - Sweden - Switzerland - United Kingdom - United States of America

www.st.com