

SV4 SERIES ANTI-VANDAL SWITCH

ANTI-VANDAL SWITCHES
DETECTOR SWITCHES
DIP SWITCHES
KEYLOCK SWITCHES
NAVIGATION SWITCHES
PUSHBUTTON SWITCHES
ROCKER SWITCHES
ROTARY SWITCHES
SLIDE SWITCHES
SNAP ACTION SWITCHES
TACTILE SWITCHES
TOGGLE SWITCHES
CAP OPTIONS

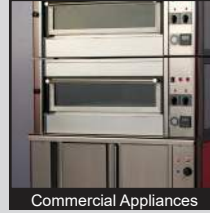

APPLICATIONS / MARKETS



RoHS

SPECIFICATIONS

Electrical Rating: 2A, 36VDC
Mechanical Life: 1,000,000 Cycles
Electrical Life: 200,000 Cycles
Contact Resistance: 50mΩ Max. at 1A 12VDC
Insulation Resistance: 1,000MΩ Min. at 500VDC
Dielectric Strength: 2,000VAC for 1 minute
Operating/Storage Temperature: -20°C to 70°C
Travel: 1.80mm
Contact Material: Silver
Moisture Protection: IP67
Mechanical Impact Protection: IK10
Contact Arrangement: SPST
Actuation Force: 4.5 N
Panel Thickness: 1-6mm
Mounting Nut Torque: 1-3Nm

FEATURES & BENEFITS

- Short body design
- 19mm diameter panel cutout
- Multiple LED options
- Ring or Ring/Power Symbol illumination available
- IP67 rated
- SPST
- Soldered wire leads (500mm long) optional

PART NUMBER CONFIGURATOR

Series	Actuator Options	Terminal Options	Function Options	Body Finish Options	Actuator Finish Options	Lens Style Options	LED-Color Options	Illumination Voltage Options
<input type="text" value="SV4"/>	<input type="text" value="F - Flat"/>	<input type="text" value="2 - Solder
W - Wire Leads
500mm long"/>	<input type="text" value="3 - 1 Pole
Off - (On)*"/>	<input type="text" value="S - Stainless
Steel"/>	<input type="text" value="S - Stainless
Steel"/>	<input type="text" value="3 - Ring moveable
with Actuator
6 - Ring / Power
Symbol moveable
with Actuator"/>	<input type="text" value="0 - White
1 - Red
3 - Green
4 - Blue
5 - Yellow
G - Red/Green
H - Red/Blue"/>	<input type="text" value="1 - Base Voltage<sup>‡</sup>"/>

NOTES:

* () denotes function is momentary

[‡]Base voltage for LED colors Red and Yellow is 2.0V @ 20mA

[‡]Base voltage for LED colors Blue, Green and White is 3.1V @ 20mA

Specifications subject to change without notice 8.1.2022



E-SWITCH®

www.e-switch.com

800.867.2717

1

SV4 SERIES ANTI-VANDAL SWITCH

BODY DIMENSIONS

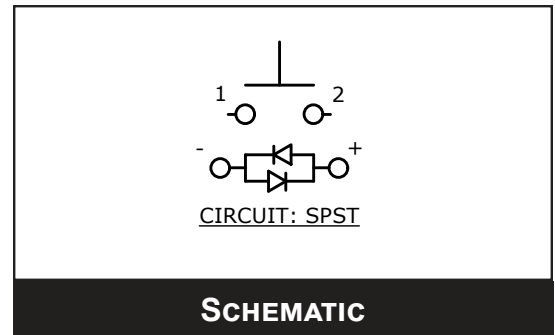
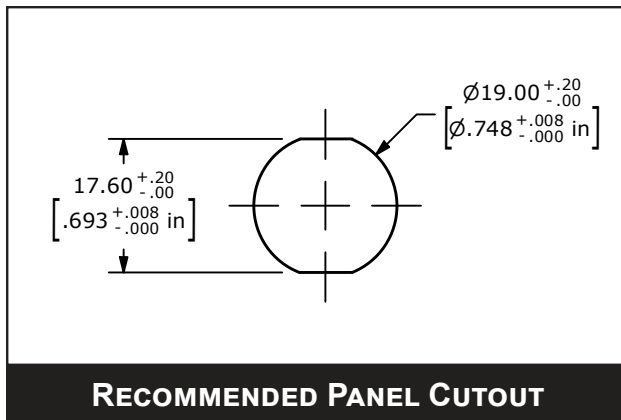
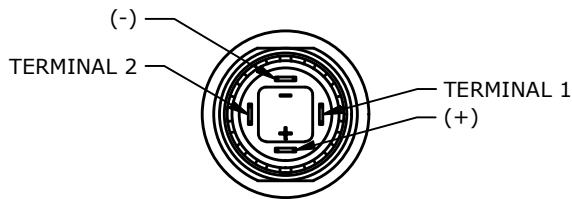
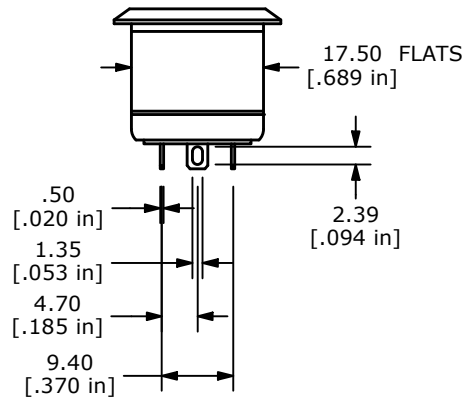
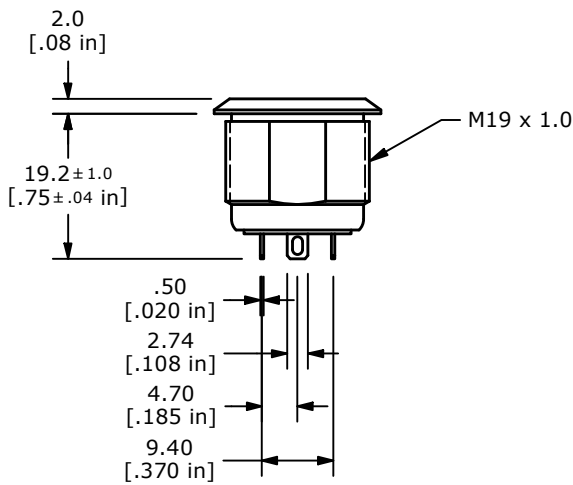
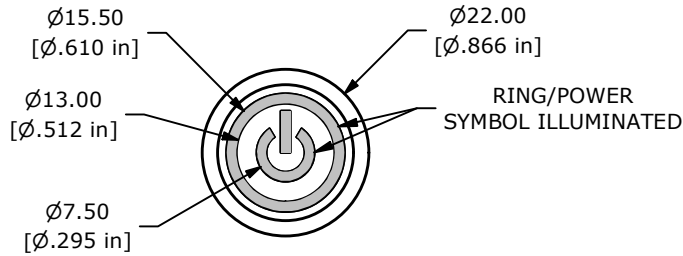

SV4 SERIES ANTI-VANDAL SWITCH

ACTUATOR OPTIONS

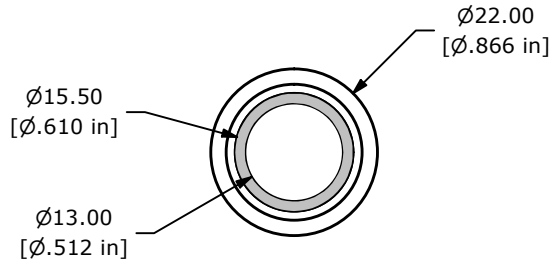

RING ILLUMINATED

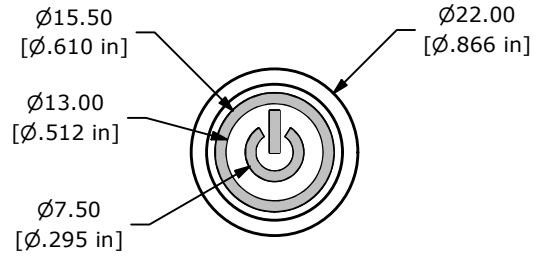

POWER SYMBOL/RING ILLUMINATED

WIRE LEAD OPTION

SWITCH	WIRE	LENGTH
SW1-1	WIRE, 20AWG AWM UL3385, BLACK	500.0 [19.7 in]
SW1-2	WIRE, 20AWG AWM UL3385, BLACK	500.0 [19.7 in]
SW1- (-)	WIRE, 20AWG AWM UL3385, GREEN	500.0 [19.7 in]
SW1- (+)	WIRE, 20AWG AWM UL3385, RED	500.0 [19.7 in]

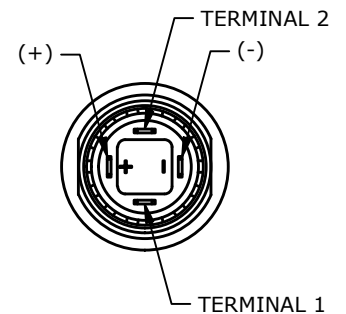
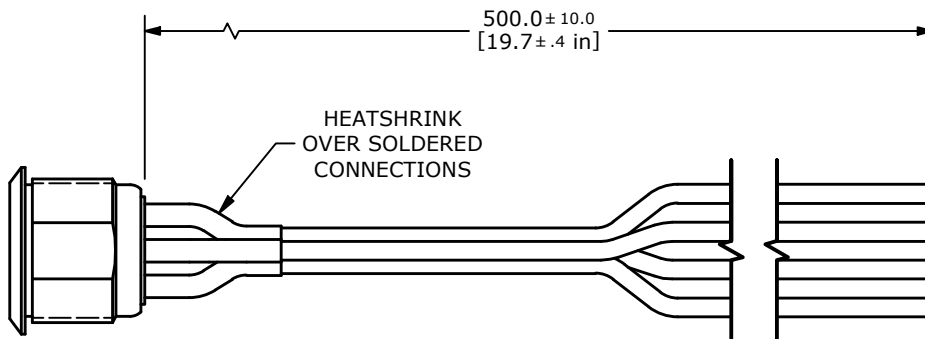

BOTTOM VIEW
SHOWN WITHOUT
WIRING

