

Thermal Overload Relays



For Use with Contactor Series K1..

Thermal Overload Relays for plug-in mounting

Setting Range D.O.L. (A) Δ (A) Type Pack pcs. Weight kg/pc. Wiring Diagram

With Manual Reset, for contactors K1-..



0,12	-	0,18	-	U12/16E 0,18 K1	1	
0,18	-	0,27	-	U12/16E 0,27 K1	1	0,10
0,27	-	0,4	-	U12/16E 0,4 K1	1	0,10
0,4	-	0,6	-	U12/16E 0,6 K1	1	0,10
0,6	-	0,9	-	U12/16E 0,9 K1	1	
0,8	-	1,2	-	U12/16E 1,2 K1	1	0,10
1,2	-	1,8	-	U12/16E 1,8 K1	1	0,10
1,8	-	2,7	-	U12/16E 2,7 K1	1	
2,7	-	4	-	U12/16E 4 K1	1	0,10
4	-	6	7 - 10,5	U12/16E 6 K1	1	
6	-	9	10,5 - 15,5	U12/16E 9 K1	1	0,10
8	-	11	14 - 19	U12/16E 11 K1	1	0,10
10	-	14	18 - 24	U12/16E 14 K1	1	0,10

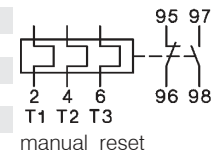

With Auto Reset, for contactors K1-..



0,12	-	0,18	-	U12/16A 0,18 K1	1	0,10
0,18	-	0,27	-	U12/16A 0,27 K1	1	0,10
0,27	-	0,4	-	U12/16A 0,4 K1	1	0,10
0,4	-	0,6	-	U12/16A 0,6 K1	1	
0,6	-	0,9	-	U12/16A 0,9 K1	1	0,10
0,8	-	1,2	-	U12/16A 1,2 K1	1	0,10
1,2	-	1,8	-	U12/16A 1,8 K1	1	0,10
1,8	-	2,7	-	U12/16A 2,7 K1	1	0,10
2,7	-	4	-	U12/16A 4 K1	1	0,10
4	-	6	7 - 10,5	U12/16A 6 K1	1	0,10
6	-	9	10,5 - 15,5	U12/16A 9 K1	1	
8	-	11	14 - 19	U12/16A 11 K1	1	0,10
10	-	14	18 - 24	U12/16A 14 K1	1	0,10

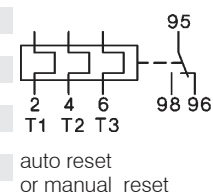

Thermal Overload Relays



With **Quick Tripping Characteristic** for EEx e motors and submersible pumps, f. contactors K1-..

0,4 - 0,6	-		U12/16EQ 0,6 K1	1	0,10
0,6 - 0,9	-		U12/16EQ 0,9 K1	1	0,10
0,8 - 1,2	-		U12/16EQ 1,2 K1	1	0,10
1,2 - 1,8	-		U12/16EQ 1,8 K1	1	
1,8 - 2,7	-		U12/16EQ 2,7 K1	1	0,10
2,7 - 4	-		U12/16EQ 4 K1	1	0,10
4 - 6	7 - 10,5		U12/16EQ 6 K1	1	0,1
6 - 9	10,5 - 15,5		U12/16EQ 9 K1	1	0,10
8 - 11	14 - 19		U12/16EQ 11 K1	1	0,10

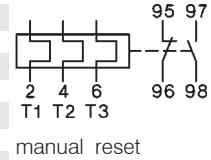

For Use with Contactor Series K3..

Thermal Overload Relays for plug-in mounting

Setting Range		Type	Pack pcs.	Weight kg/pc.	Wiring Diagram
D.O.L. (A)	Δ (A)				

With **Manual Reset**, for contactors K(G)3-10.. to K(G)3-22... ..



0,12 - 0,18	-		U12/16E 0,18 K3	1	0,10
0,18 - 0,27	-		U12/16E 0,27 K3	1	0,10
0,27 - 0,4	-		U12/16E 0,4 K3	1	0,10
0,4 - 0,6	-		U12/16E 0,6 K3	1	
0,6 - 0,9	-		U12/16E 0,9 K3	1	
0,8 - 1,2	-		U12/16E 1,2 K3	1	0,10
1,2 - 1,8	-		U12/16E 1,8 K3	1	0,10
1,8 - 2,7	-		U12/16E 2,7 K3	1	0,10
2,7 - 4	-		U12/16E 4 K3	1	
4 - 6	7 - 10,5		U12/16E 6 K3	1	
6 - 9	10,5 - 15,5		U12/16E 9 K3	1	0,10
8 - 11	14 - 19		U12/16E 11 K3	1	0,10
10 - 14	18 - 24		U12/16E 14 K3	1	0,10
13 - 18	23 - 31		U12/16E 18 K3	1	0,10
17 - 23	30 - 40		U12/16E 23 K3	1	0,10
22 - 30	38 - 52		U12/16E 30 K3	1	0,13

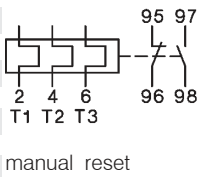

With **quick Tripping Characteristic** for EEx e motors and under water pumps



0,4 - 0,6	-		U12/16EQ 0,6 K3	1	
0,6 - 0,9	-		U12/16EQ 0,9 K3	1	
0,8 - 1,2	-		U12/16EQ 1,2 K3	1	0,10
1,2 - 1,8	-		U12/16EQ 1,8 K3	1	
1,8 - 2,7	-		U12/16EQ 2,7 K3	1	0,10
2,7 - 4	-		U12/16EQ 4 K3	1	0,10
4 - 6	7 - 10,5		U12/16EQ 6 K3	1	0,10
6 - 9	10,5 - 15,5		U12/16EQ 9 K3	1	0,10
8 - 11	14 - 19		U12/16EQ 11 K3	1	0,10
10 - 14	18 - 24		U12/16EQ 14 K3	1	

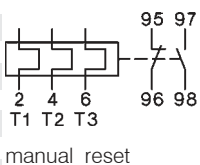

Thermal Overload Relays

For contactors K(G)3-10.. to K(G)3-40A..



0,12 - 0,18	-	U3/32 0,18	1	0,1
0,18 - 0,27	-	U3/32 0,27	1	
0,27 - 0,4	-	U3/32 0,4	1	
0,4 - 0,6	-	U3/32 0,6	1	0,14
0,6 - 0,9	-	U3/32 0,9	1	0,14
0,8 - 1,2	-	U3/32 1,2	1	0,14
1,2 - 1,8	-	U3/32 1,8	1	
1,8 - 2,7	-	U3/32 2,7	1	0,14
2,7 - 4	-	U3/32 4	1	
4 - 6	7 - 10,5	U3/32 6	1	0,14
6 - 9	10,5 - 15,5	U3/32 9	1	
8 - 11	14 - 19	U3/32 11	1	0,14
10 - 14	18 - 24	U3/32 14	1	
13 - 18	23 - 31	U3/32 18	1	0,14
17 - 24	30 - 41	U3/32 24	1	0,14
23 - 32	40 - 55	U3/32 32	1	0,14

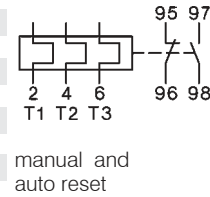

For contactors K(G)3-24A.. to K(G)3-40A ..



10 - 14	18 - 24	U3/42 14	1	0,30
14 - 20	24 - 35	U3/42 20	1	0,30
20 - 28	35 - 48	U3/42 28	1	
28 - 42	48 - 73	U3/42 42	1	0,30

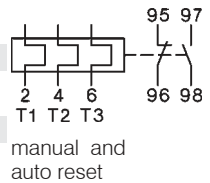

Setting Range D.O.L. (A)	$\Upsilon\Delta$ (A)	Type	Pack pcs.	Weight kg/pc.	Wiring Diagram
-----------------------------	----------------------	------	-----------	---------------	----------------

For contactors K3-50A.. to K3-74A..



20 - 28	35 - 48	U3/74 28	1	0,40
28 - 42	48 - 73	U3/74 42	1	
40 - 52	70 - 90	U3/74 52	1	
52 - 65	90 - 112	U3/74 65	1	
60 - 74	104 - 128	U3/74 74	1	0,40

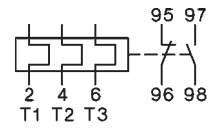

manual and auto reset

For Use with Contactor Series K3..

Thermal Overload Relays for separate mounting

Setting Range D.O.L. (A)	$\Upsilon\Delta$ (A)	Type	Pack pcs.	Weight kg/pc.	Wiring Diagram
-----------------------------	----------------------	------	-----------	---------------	----------------

For contactors K3-90, K3-115, K85, K110



60 - 90	104 - 156	U85 90	1	0,90
80 - 120	140 - 207	U85 120		

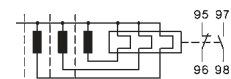

manual reset

Thermal Overload Relays

Accessories



for overload relays	for contactors	Type	Pack set	Weight kg/set
Busbar Sets				
U800	K3-450.., K3-550..	SU840/550	1	1,7
U800	K3-700.., K3-860..	SU840/860	1	2,1



Cable Cross-section (mm ²)	Type		Pack pcs.	Weight kg/pc.
overload relay	solid or stranded	flexible		
for Single Mounting U12/16..K3 Base for DIN-rail mounting plus terminals				
U12/16..K3	0,75 - 6	0,75 - 4	U12SM K3	1 0,035



for Single Mounting U3/32 Additional Terminals with fingertouch protection (U3/32 relays have base for DIN rail mounting integrated)				
U3/32	0,75 - 6	0,75 - 4	U3/32SM	1 0,035



for Single Mounting U3/42 or U3/74 Base for DIN-rail mounting				
U3/42, U3/74	-	-	U3/42G	1 0,030



for Single Mounting U3/42 or U3/74 Connecting Wire Set (3 pcs.)				
U3/42, U3/74	150mm length	10mm ²	LG5830-4	1 0,060
U3/42, U3/74	250mm length	10mm ²	LG5830-2	1 0,100



Additional Terminals with fingertouch protection				
1-pole f. U12/16, U3/32	0,75 - 10	0,75 - 6	LG9339	1 0,009
3-pole for U3/42	4 - 35	6 - 25	LG7559	1 0,052

Thermal Overload Relays, tripping times for selection to motors of protection degree EEx e

Relays With Standard Tripping Characteristic

Setting Range Tripping time depending on the multiple of the current setting from cold condition (tolerance $\pm 20\%$ of the tripping time)

A	A	I_A/I_N 3	I_A/I_N 4	I_A/I_N 5	I_A/I_N 6	I_A/I_N 7,2	I_A/I_N 8
U3/32 ..							
0,12 -	0,18	16,1	9,6	6,8	5,3	4,2	3,7
0,18 -	0,27	16,6	9,7	6,7	5,2	4,1	3,6
0,27 -	0,4	19,4	11,4	7,9	6,1	4,7	4,2
0,4 -	0,6	18,7	10,9	7,6	5,9	4,6	4,0
0,6 -	0,9	19,2	11,2	7,7	5,9	4,6	4,1
0,8 -	1,2	20,8	12,3	8,5	6,6	5,2	4,6
1,2 -	1,8	25,5	14,1	9,8	7,6	5,9	5,2
1,8 -	2,7	26,6	15,6	10,9	8,3	6,5	5,7
2,7 -	4	22,7	13,6	9,5	7,4	5,8	5,1
4 -	6	22,2	13,3	9,3	7,1	5,6	4,9
6 -	9	20,4	11,9	8,2	6,1	4,7	4,0
8 -	11	20,9	11,8	7,9	5,7	4,3	3,5
10 -	14	21,3	11,7	7,4	5,1	3,7	3,0
13 -	18	21,2	12,1	8,0	6,2	4,6	4,1
17 -	24	20,4	12,0	8,6	6,3	4,5	3,7
23 -	32	20,2	10,2	6,7	4,7	3,4	2,8
U3/42							
10 -	14	21,8	11,4	7,0	5,0	3,7	2,8
14 -	20	22,4	11,2	6,7	4,5	3,2	2,4
20 -	28	21,8	10,8	6,5	4,5	3,3	2,5
28 -	42	25,2	13,3	8,0	5,5	4,0	3,1
U3/74							
20 -	28	21,8	10,8	6,5	4,5	3,3	2,5
28 -	42	25,2	13,3	8,0	5,5	4,0	3,1
40 -	52	18,3	9,2	5,6	3,9	2,8	2,2
52 -	65	17,8	8,7	5,2	3,4	2,5	1,9
U85 ..							
60 -	90	19,5	13,5	11,0	10,0	9,5	8,5
80 -	120	18,0	11,0	10,0	9,0	8,5	8,0
U840 ..							
260 -	360	23,3	14,1	10,0	7,6	6,1	5,4
340 -	480	23,0	13,8	9,6	7,6	6,1	5,4
440 -	620	20,5	12,4	9,0	7,0	5,5	5,0
560 -	800	21,0	12,5	9,0	7,0	5,6	5,2
U12/16E(A) ..							
0,12 -	0,18	18,5	10,4	7,2	5,5	4,3	3,6
0,18 -	0,27	16,7	9,8	6,5	5,0	4,1	3,5
0,27 -	0,4	19,4	12,1	8,2	5,9	4,9	4,2
0,4 -	0,6	18,7	11,2	8,0	6,0	4,9	4,1
0,6 -	0,9	19,7	11,6	8,1	6,1	4,9	4,2
0,8 -	1,2	22,9	13,6	10,0	7,3	6,0	5,2
1,2 -	1,8	22,2	13,2	9,2	7,6	5,8	5,3
1,8 -	2,7	23,0	13,7	9,3	7,6	5,7	5,1
2,7 -	4	24,0	14,4	9,9	7,8	5,9	5,1
4 -	6	24,7	13,8	9,9	7,3	5,6	4,8
6 -	9	22,0	13,4	8	5,7	4,1	3,5
8 -	11	17,4	9,2	5,9	4,1	2,9	2,3
10 -	14	26,4	12,9	7,6	5,2	3,5	2,8
13 -	18	14,7	7,7	4,8	3,2	2,3	1,7
17 -	23	16,2	8,4	5,0	3,6	2,4	1,8
22 -	30	16,8	8,5	5,0	3,6	2,3	1,9

Relays With Quick Tripping Characteristic

preferably for motors with short t_E time and for submersible pumps

Setting Range Tripping time depending on the multiple of the current setting from cold condition (tolerance $\pm 20\%$ of the tripping time)

A	A	I_A/I_N 3	I_A/I_N 4	I_A/I_N 5	I_A/I_N 6	I_A/I_N 7,2	I_A/I_N 8
U12/16EQ ..							
0,4 -	0,6	13,6	8,4	5,9	4,2	3,3	3,0
0,6 -	0,9	13,8	7,8	5,2	4,1	3,2	2,7
0,8 -	1,2	13,1	7,5	5,2	3,9	3,1	2,7
1,2 -	1,8	14,6	8,7	6,0	4,6	3,6	3,2
1,8 -	2,7	13,5	7,6	5,3	3,9	3,1	2,7
2,7 -	4	11,0	6,0	4,1	2,6	1,7	1,4
4 -	6	9,6	5,3	3,3	2,3	1,6	1,3
6 -	9	10,2	5,4	3,4	2,3	1,6	1,3
8 -	11	12,0	6,2	3,9	2,5	1,8	1,3
10 -	14	12,8	6,6	4,0	2,6	1,8	1,4

All tripping times of overload relays U12/16EQ are shorter than the minimum values of the t_E time for motors of protection degree EEx e acc. to EN 50019 and therefore are suitable for all motors of protection degree EEx e. For these overload relays the selection on basis of tripping curves is thereby not necessary.

When selecting a standard overload, refer to the tripping curve. Determine the values of the starting current ratio I_A/I_N and the time t_E which is marked on the label of the motor. The overload must trip within the t_E time, which means that the tripping curve from cold condition must be (20% due to tolerance) below the co-ordination point I_A/I_N and the time t_E .
 I_A = Starting current of motor I_N = Rated current of motor
 t_E = t_E -time of motor

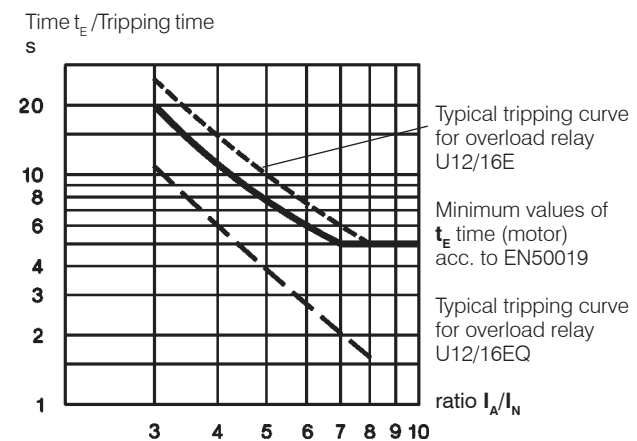

Example of selection for thermal overload relay:

Technical data of a motor protection EEx e
 $P_N = 1,5kW$ $I_N = 3,6A$ $I_A/I_N = 5$ t_E time = 8s

1) U12/16E 4 (2,7 - 4A)
 Tripping time at $5 \times I_N = 9,9s$
 $9,9s + 20\% \text{ tolerance} = 11,9s > t_{E \text{ Motor}} = 8s$
 The device U12/16E 4 is **not suitable**.

2) U12/16EQ 4 (2,7 - 4A)
 Tripping time at $5 \times I_N = 4,1s$
 $4,1s + 20\% \text{ tolerance} = 4,9s < t_{E \text{ Motor}} = 8s$
The device U12/16EQ 4 is therefore suitable for motor protection

DATA SHEET

Thermal Overload Relays Fuses for U3/32, U3/42, U3/74, U12/16E, U85, U180, U320 and U800

Type	Setting Range		Max. Fuse Size According to Coordination-type				Fuse UL	SCCR
	DOL	Δ	"2" ¹⁾		"1" ¹⁾			
			quick	slow, gL(gG)	slow, gL(gG)	aM		
A	A	A	A	A	A	A	kA	
U3/32 (U12/16E)	0,12 - 0,18	-	0,5 ²⁾	0,5 ²⁾	25	-	15	5
	0,18 - 0,27	-	1,0 ²⁾	1,0 ²⁾	25	-	15	5
	0,27 - 0,4	-	2	2	25	-	15	5
	0,4 - 0,6	-	2	2	25	-	15	5
	0,6 - 0,9	-	4	4	25	-	15	5
	0,8 - 1,2	-	4	4	25	2	15	5
	1,2 - 1,8	-	6	6	25	2	15	5
	1,8 - 2,7	-	10	10	25	4	15	5
	2,7 - 4	-	16	10	25	4	15	5
	4 - 6	7 - 10,5	20	16	25	6	15	5
	6 - 9	10,5 - 15,5	35	25	35	10	25	5
	8 - 11	14 - 19	35	25	35	16	30	5
	10 - 14	18 - 24	50	35	63	16	40	5
13 - 18	23 - 31	50	35	63	20	50	5	
17 - (23)24	30 - (40)41	63	50	63	25	60	5	
(22)23 - (30)32	(38)40 - (52)55	80	63	80	35	70	5	
U3/42	10 - 14	18 - 24	50	35	80	16	40	5
	14 - 20	24 - 35	63	50	80	25	60	5
	20 - 28	35 - 48	80	63	80	35	80	5
	28 - 42	48 - 73	100	80	150	50	110	5
U3/74	20 - 28	35 - 48	100	80	150	35	80	5
	28 - 42	48 - 73	125	100	150	50	110	5
	40 - 52	70 - 90	160	100	150	63	200	5
	52 - 65	90 - 112	160	125	150	80	250	10
	60 - 74	104 - 128	160	125	150	80	250	10
U85	60 - 90	104 - 156					300	10
	80 - 120	140 - 207					-	10
U180, U320 U800	all ranges all ranges						-	-

For short circuit protecting overload relays with current transformer use fuse according to the contactor of the combination.

Tripping Characteristics for U3/32, U3/42, U3/74 and U12/16E

Detailed tripping times for each range see table page 124

with three-phase load

Tripping time (Average value of typical tolerance curves from cold condition)

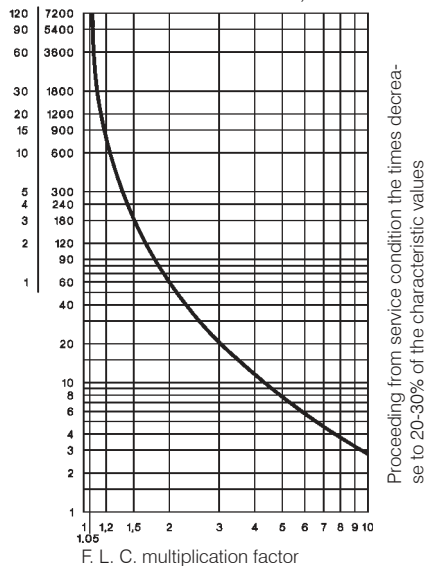

with two-pole load

Tripping time (Typical tolerance curve from cold condition)

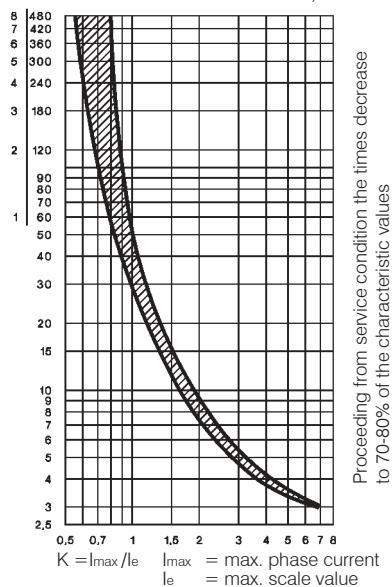

- 1) Coordination-type according to IEC 947-4-1:
"2": Light contact welding accepted. Thermal overload relay must not be damaged.
"1": Welding of contactor and damage of the thermal overload relay allowed.
- 2) Miniature fuse

- 3) Suitable for use on a capability of delivering not more than

Thermal Overload Relays

Tripping Characteristics for U85, U180, U320, and U800

Detailed tripping times for each range of U85 see table page 124

U85 with three-phase load

Tripping time (Average value of typical tolerance curves from cold condition)

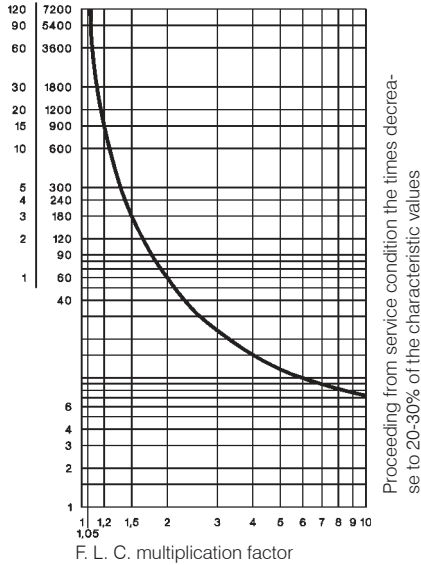

U180, U320 with three-phase load

Tripping time (Average value of typical tolerance curves from cold condition)

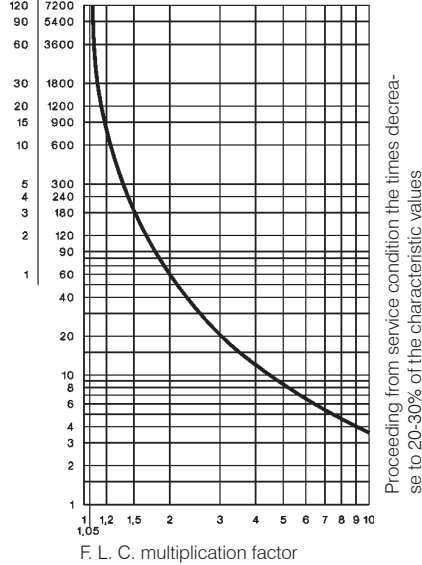

U800 with three-phase load

Tripping time (Average value of typical tolerance curves from cold condition)

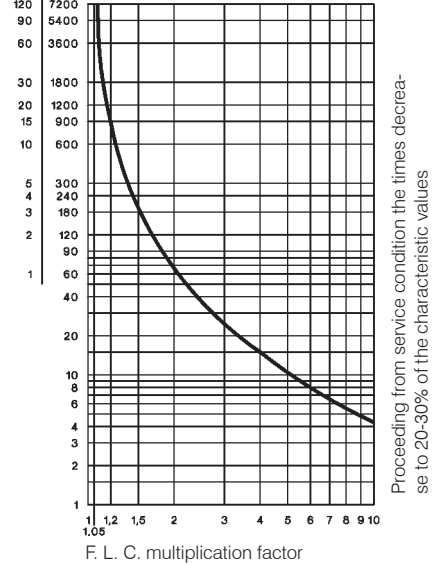

U85 with two-pole load

Tripping time (Typical tolerance curve from cold condition)

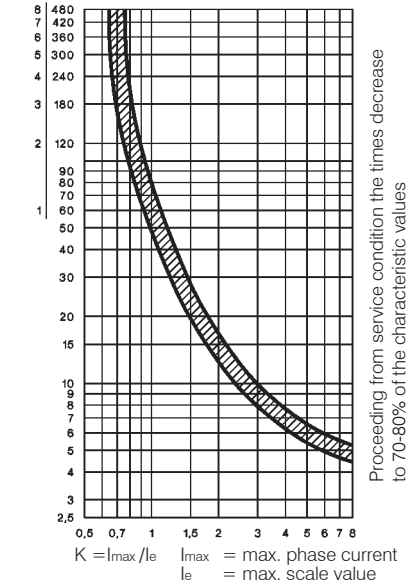

Position of Terminals

U3/32

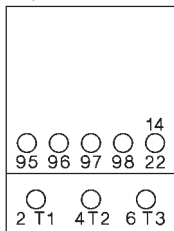

U12/16E, U12/16EM, U12/16EQ

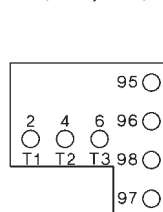

U12/16A

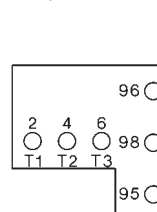

U3/42, U3/74

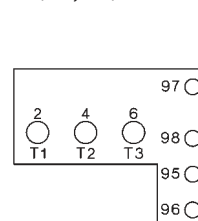

Thermal Overload Relays in Special Version

Fuse for U12/16EQ

Setting Range	Maximum Fuse Acc. to Coordination-type "2" ¹⁾		
	quick A	slow, gL(gG) A	slow, gL(gG) A
0,4 - 0,6	2	2	25
0,6 - 0,9	4	4	25
0,8 - 1,2	4	4	25
1,2 - 1,8	6	6	25
1,8 - 2,7	10	10	25
2,7 - 4	16	10	25
4 - 6	20	16	25
6 - 9	35	25	35
8 - 11	35	25	35
10 - 14	50	35	63

Fuse for U12/16EM

Setting Range	Maximum Fuse Acc. to Coordination-type "2" ¹⁾		
	380-400V slow, gL(gG) A	500V slow, gL(gG) A	660-690V slow, gL(gG) A
0,12 - 0,18	none	none	on request
0,18 - 0,27	none	none	on request
0,27 - 0,4	none	none	on request
0,4 - 0,6	none	none	on request
0,6 - 0,9	none	none	on request
0,8 - 1,2	none	10	on request
1,2 - 1,8	none	16	on request
1,8 - 2,7	20	20	on request
2,7 - 4	35	35	on request

Tripping Characteristic for U12/16EQ

Detailed tripping times for each range see table page 124

with three-phase load

range 0,4-0,6 to 1,8-2,7A
 Tripping time (Typical tolerance curve from cold condition)

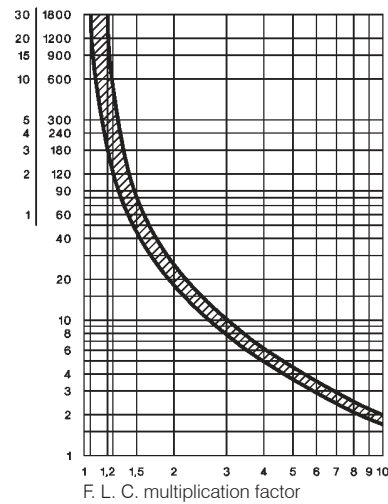

range 2,7-4 to 10-14A

Tripping time (Typical tolerance curve from cold condition)

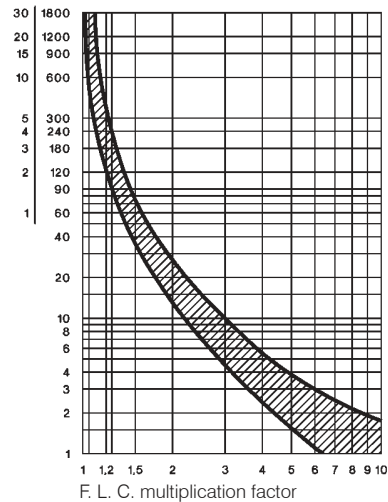

Tripping Characteristic for U12/16EM

with three-phase load

Tripping time (Average value of typical tolerance curves from cold condition)

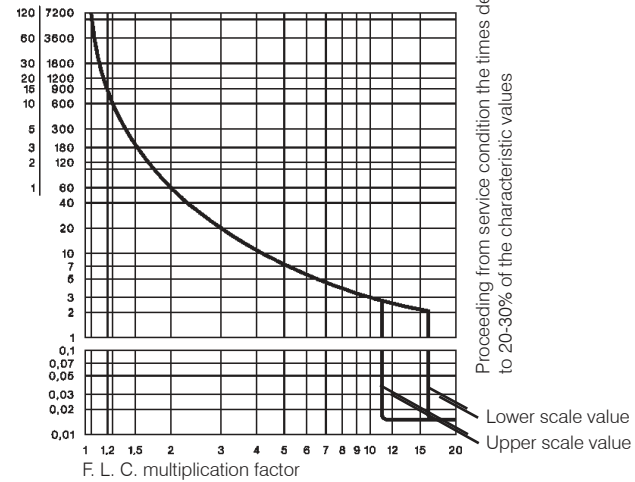

1) Coordination-type according to IEC 947-4-1:

"2": Light contact welding accepted. Thermal overload relay must not be damaged.

"1": Welding of contactor and damage of the thermal overload relay allowed.

DATA SHEET

Thermal Overload Relays

Data according to IEC 947-4-1, IEC 947-5-1, VDE 0660, EN 60947-4-1, EN 60947-5-1

Type		U3/32	U12/16 ⁶⁾	U3/42	U3/74	U85	U180	U320	U800
Rated insulation voltage U_i ¹⁾	V~	690	690	690	690	750	1000	1000	1000
Permissible ambient temperature									
operation	open °C			-25 to +60					-25 to +55
storage	°C			-50 to +70					-40 to +70
Trip class according to IEC 947-4-1	10A	10A	10A	10A	20	10A	10A		10
Cable cross-section									
main connector	solid or stranded mm ²	0,75-6	0,75-6+0,75-2,5 ²⁾	0,75-10	4-35 ²⁾	³⁾	⁷⁾	-	⁷⁾
	flexible mm ²	1-4	0,75-4+0,5-2,5 ²⁾	0,75-6	6-25 ²⁾				
	flexible with multicore cable end mm ²	0,75-4	0,5-2,5+0,5-1,5	0,75-6	4-25				
Cables per clamp	number	2	1+1	2	1				
auxiliary connector	solid mm ²			0,75-2,5 ²⁾					1-2,5 ²⁾
	flexible mm ²			0,5-2,5 ²⁾					1-2,5 ²⁾
	flexible with multicore cable end mm ²			0,5-1,5					1-2,5 ²⁾
Cables per clamp	number			2					2

Type		U3/32	U12/16A	U12/16E	U12/16EQ	U3/42	U85	U180	U800
				U12/16EM		U3/74		U320	
Auxiliary contacts									
Rated insulation voltage U_i ¹⁾									
same potential	V~	690	690	690	690	690	690	690	500
different potential	V~	440	-	440	440	250	440	440	500
Utilization category AC15									
Rated operational	24V A	3	4	5	5	4	5	3	4 ⁵⁾
current I _e	230V A	2	2,5	3	3	2,5	3	2	2,5
	400V A	1	1,5	2	2	1,5	2	1	1,5
	690V A	0,5	0,6	0,6	0,6	0,6	0,6	0,5	0,6
Utilization category DC13									
Rated operational	24V A	1	1,2	1,2	1,2	1,2	1,2	1	1,2
current I _e	110V A	0,15	0,15	0,15	0,15	0,15	0,15	0,15	0,15
	220V A	0,1	0,1	0,1	0,1	0,1	0,1	0,1	0,1
Short circuit prot. (without welding 1kA)									
highest fuse rating	gL (gG) A	4	4	6	6	6	6	4	6

Type		U3/32	U12/16	U12/16E	U3/42	U3/42	U3/74	U3/74	U85
Setting range		all	to 23A	22 - 30A	to 28A	28 - 42A	to 52A	52 - 65A	all
Power loss per current path (max.)									
minimum setting value	W	1,1	1,1	1,7	1,3	1,3	2,0	2,9	1,1
maximum setting value	W	2,3	2,3	3,7	2,6	3,3	3,7	4,5	2,5

Data according to cULus

Type		U3/32	U12/16A	U12/16E	U3/42	U3/74	U85
Rated insulation voltage	V~	600	600	600	600	600	600
Rated current	A	32	23	23	42	75	85
Auxiliary contacts							
Rated voltage							
same potential	V~	600	600	600	600		600
different potential	V~	150	-	150	150	150	150
Switching capacity AC	VA	500	500	500	600	600	600
of aux. contacts	A	2	3	4	4	4	4

Temperature Compensation

In case of higher ambient temperature use the following formula:
(Ambient temperature - 20) x 0,125 = correction factor in % of the full load motor current

Example: Ambient temperature 70°C, full load motor current 7A
(70 - 20) x 0,125 = 6,25%
Setting value: 7A + 6,25% = 7,44A

1) Suitable for: earthed-neutral systems, overvoltage category I to III, pollution degree 3 (standard-industry): U_{imp} = 4kV (at 440V), 6kV (at 690V). Data for other conditions on request.

2) Maximum cable cross-section with prepared conductor

3) Without terminals, suitable for bushing one connector 70mm² (stranded) per phase

4) Switching capacity of the start contact: AC15 300VA, max. 1,5A, DC13 (max. 220V) 30W, max. 1,5A

5) Switching capacity of the make contact: AC15 400VA, max. 1,7A, DC13 (max. 220V) 10W, max. 1A

6) U12/16E 30: Cable cross-section for main connector like type U3/42, one connector only

7) Busbar sets see accessories page 123

Thermal Overload Relays

Dimensions

K3-10N + U3/32

K3-14N

K3-18N

K3-22N

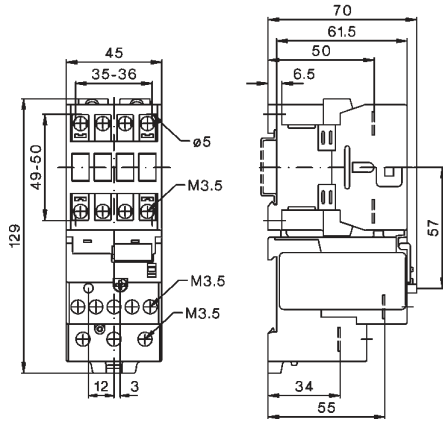

KG3-10 + U3/32

KG3-14

KG3-18

KG3-22

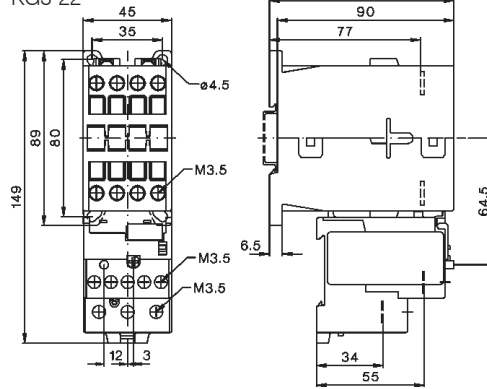

K3-24 + U3/32

K3-32

K3-40

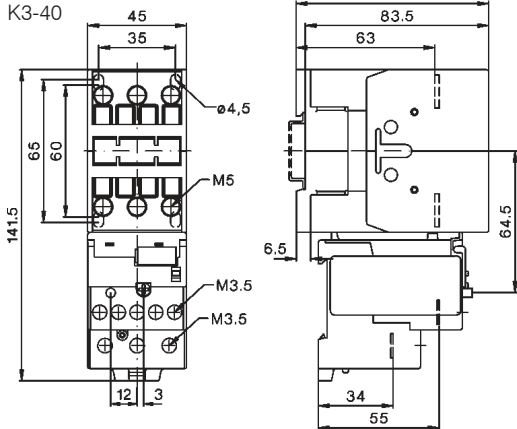

KG3-24 + U3/32

KG3-32

KG3-40

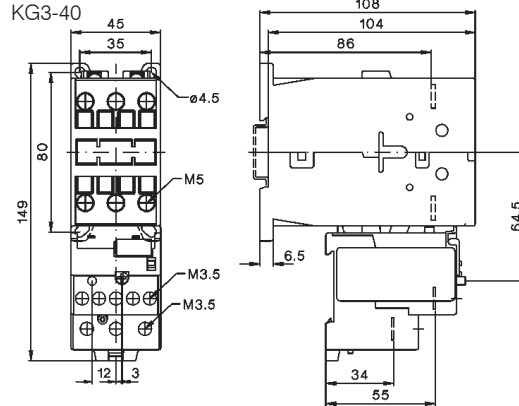

K3-24 + U3/42

K3-32

K3-40

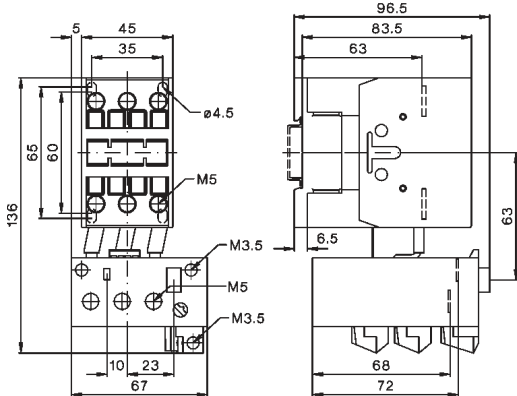

KG3-24 + U3/42

KG3-32

KG3-40

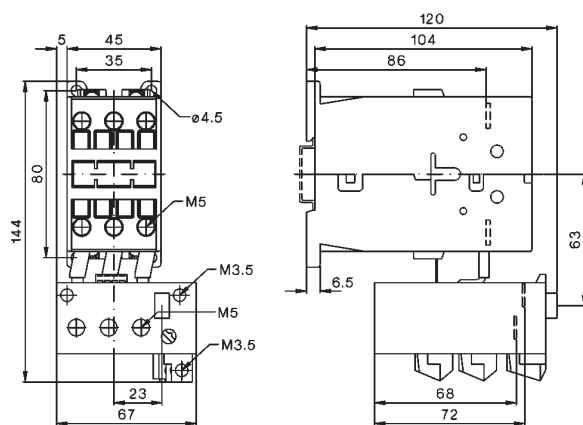

Thermal Overload Relays

U3/32SM

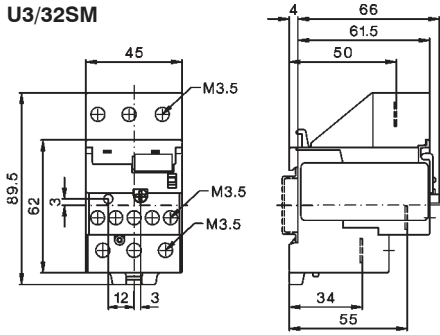

U3/42G + LG5830-

Changing of connecting wire with 1,8Nm

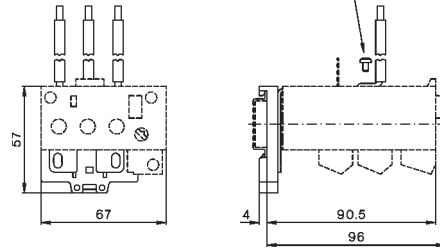

K1-09 + U12/16.. K1
K1-12

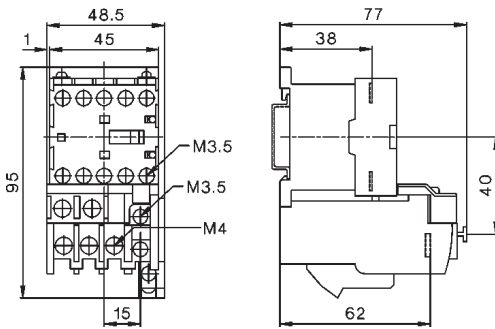

K3-10 + U12/16..K3
K3-14
K3-18
K3-22

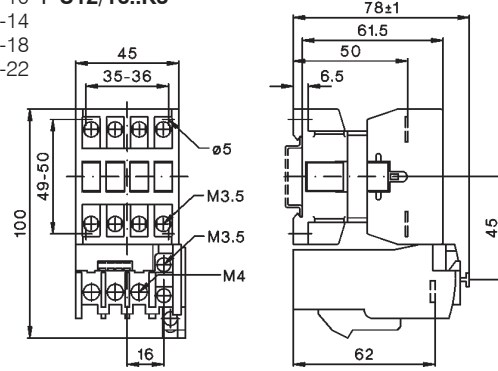

K3-10N + U12/16..K3
K3-14N
K3-18N
K3-22N

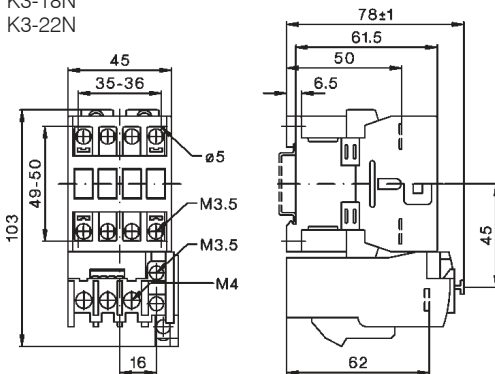

KG3-10 + U12/16..K3
KG3-14
KG3-18
KG3-22

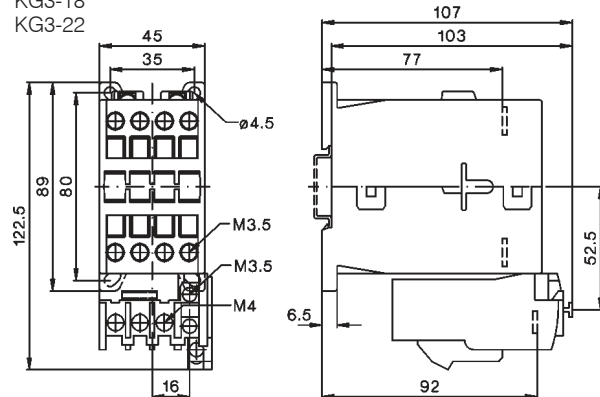

Thermal Overload Relays

U12SM K3

U12/16..K3 + U12SM K3 for snap-on 35mm DIN-rail according to DIN EN50022 and screw mounting (single mounting)

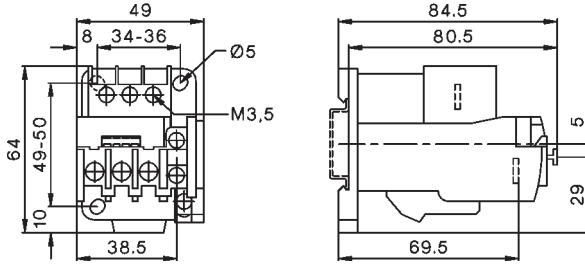

K3-50 + U3/74

K3-62
K3-74

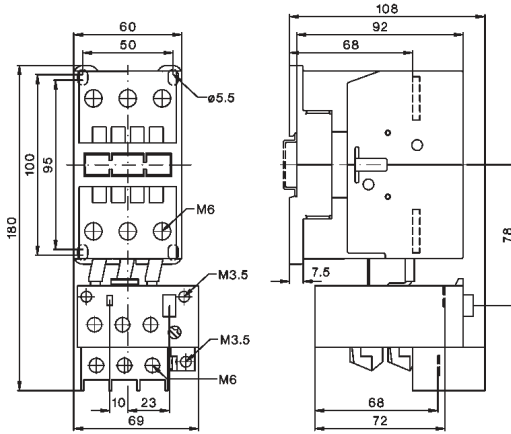

K3-90A + U85

K3-115A

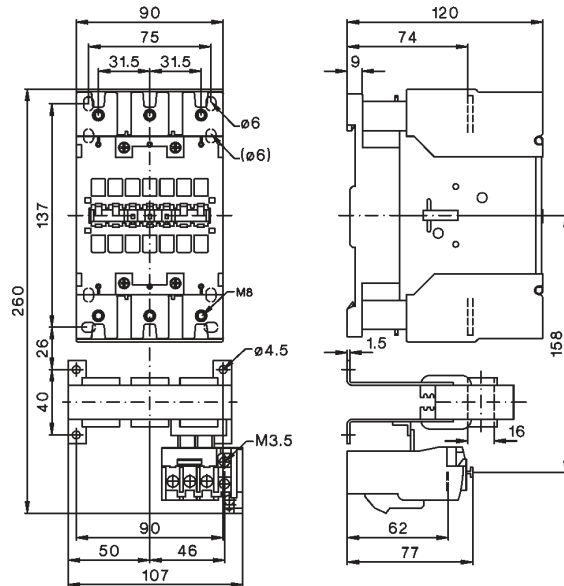

Thermal Overload Relays

K3-151A00 + U180
K3-176A00

Mounting holes

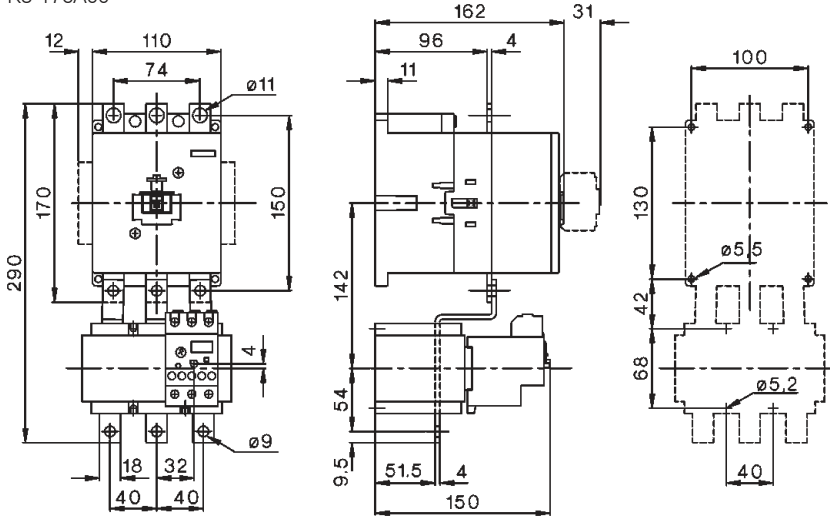

K3-210A00 + U320
K3-260A00
K3-316A00

Mounting holes

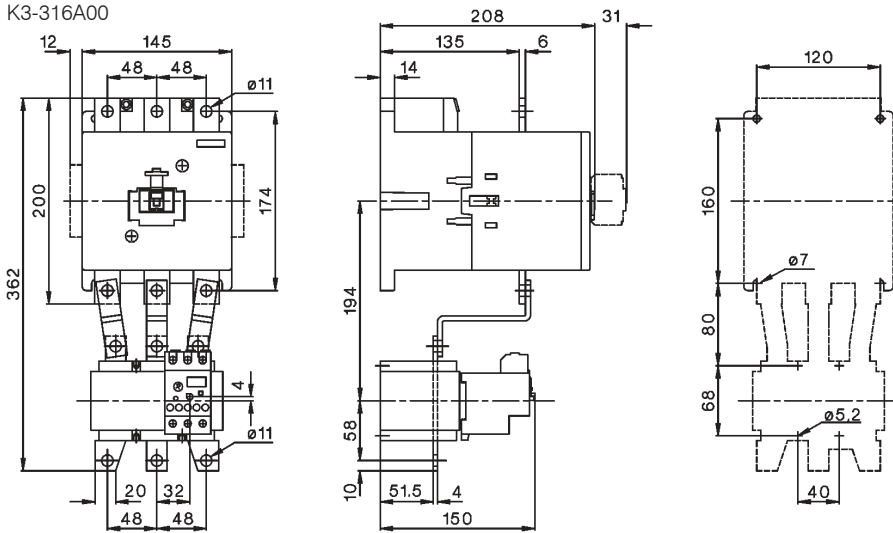

Thermal Overload Relays

U800

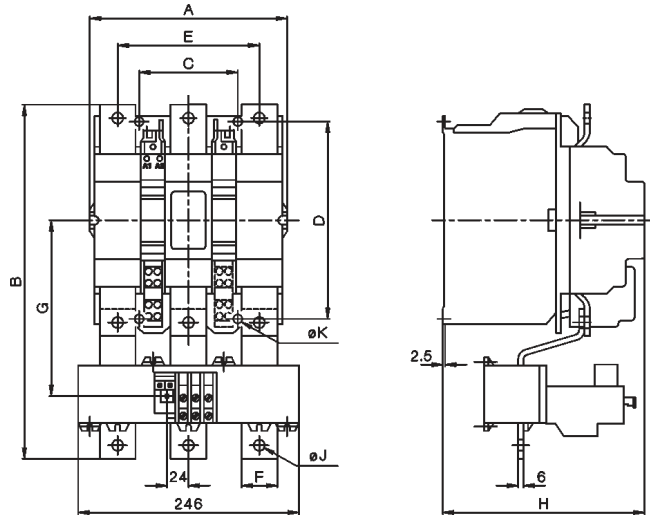
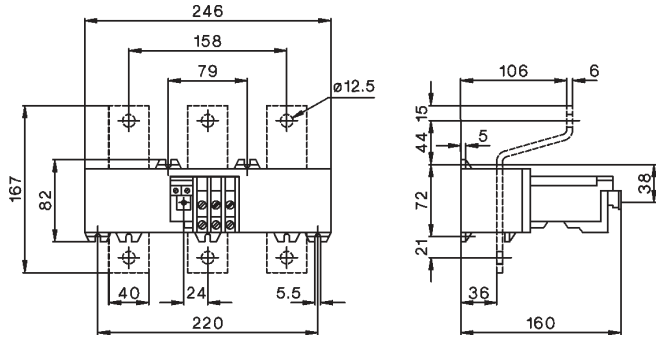

U800 with	A	B	C	D	E	F	G	H	J	K
K3-450	220	372	110	220	158	40	185	225	12,5	9
K3-550	220	395	110	220	158	40	196	225	12,5	9
K3-700	280	487	175	280	202	50	257	291	14,5	11
K3-860	280	540	175	280	202	50	280	291	14,5	11