

- Low Offset Characteristics
- High Differential Voltage Amplification
- Fast Response Times
- Output Compatible with Most TTL Circuits

description

The TL510 monolithic high-speed voltage comparator is an improved version of the TL710 with an extra stage added to increase voltage amplification and accuracy, and a strobe input for greater flexibility. Typical voltage amplification is 33,000. Since the output cannot be more positive than the strobe, a low-level input at the strobe will cause the output to go low regardless of the differential input. Component matching, inherent in integrated circuit fabrication techniques, produces a comparator with low-drift and low-offset characteristics. These circuits are particularly useful for applications requiring an amplitude discriminator, memory sense amplifier, or a high-speed limit detector.

The TL510M is characterized for operation over the full military temperature range of -55°C to 125°C ; the TL510C is characterized for operation from 0°C to 70°C .

functional block diagram (positive logic)

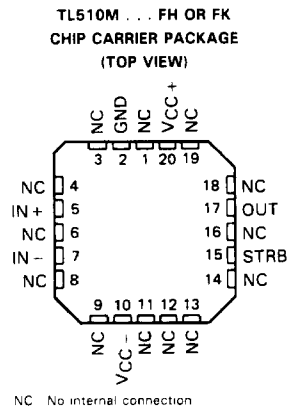
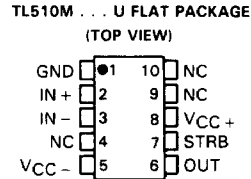
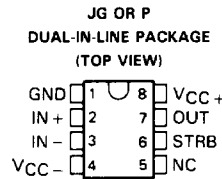
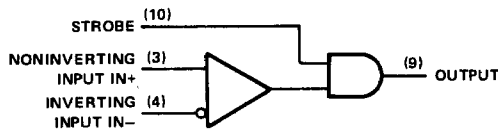

TYPES TL510M, TL510C DIFFERENTIAL COMPARATORS WITH STROBE

schematic

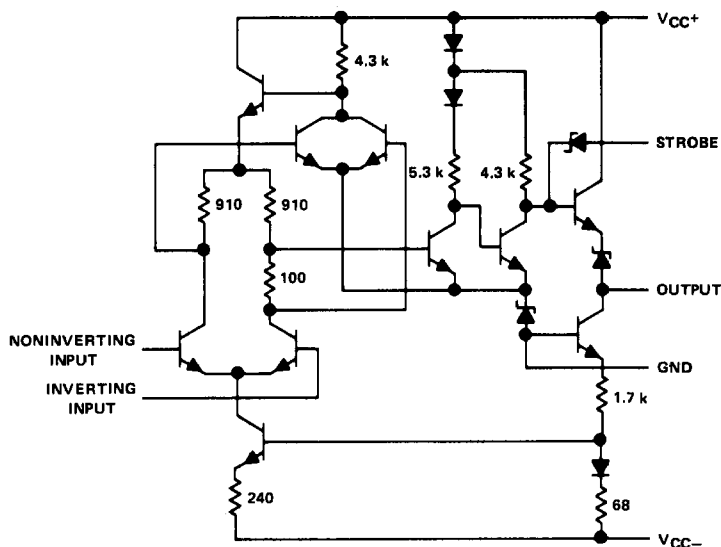

Resistor values shown are nominal in ohms.
Component values shown are nominal.

4

Voltage Comparators

absolute maximum ratings over operating free-air temperature range (unless otherwise noted)

Supply voltage V_{CC+} (see Note 1)	14 V
Supply voltage V_{CC-} (see Note 1)	-7 V
Differential input voltage (see Note 2)	± 5 V
Input voltage (either input, see Note 1)	± 7 V
Strobe voltage (see Note 1)	6 V
Peak output current ($t_W \leq 1$ s)	10 mA
Continuous total power dissipation at (or below) 70°C free-air temperature (see Note 3)	300 mW
Operating free-air temperature range: TL510M Circuits	-55°C to 125°C
TL510C Circuits	0°C to 70°C
Storage temperature range	-65°C to 150°C
Lead temperature 1,6 mm (1/16 inch) from case for 60 seconds: FH, FK, JG, or U package	300°C
Lead temperature 1,6 mm (1/16 inch) from case for 10 seconds: P package	260°C

- NOTES: 1. All voltage values, except differential voltages, are with respect to the network ground terminal.
2. Differential voltages are at the noninverting input terminal with respect to the inverting input terminal.
3. For operation of the TL510M above 70°C free-air temperature, refer to Dissipation Derating Curves, Section 2. In the JG package, TL510M chips are alloy mounted and TL510C chips are glass mounted.

TYPES TL510M, TL510C DIFFERENTIAL COMPARATORS WITH STROBE

electrical characteristics at specified free-air temperature, $V_{CC+} = 12\text{ V}$, $V_{CC-} = -6\text{ V}$
(unless otherwise noted)

PARAMETER	TEST CONDITIONS†	TL510M			TL510C			UNIT
		MIN	TYP	MAX	MIN	TYP	MAX	
V_{IO} Input offset voltage	$R_S \leq 200\ \Omega$, See Note 4	25°C	0.6	2	1.6	3.5	mV	
		Full range	3		4.5			
α_{VIO} Average temperature coefficient of input offset voltage	$R_S = 50\ \Omega$, See Note 4	MIN to 25°C	3	10	3	20	$\mu\text{V}/^\circ\text{C}$	
		25°C to MAX	3	10	3	20		
I_{IO} Input offset current	See Note 4	25°C	0.75	3	1.8	5	μA	
		MIN	1.8	7		7.5		
		MAX	0.25	3				
α_{IIO} Average temperature coefficient of input offset current	See Note 4	MIN to 25°C	15	75	24	100	$\text{nA}/^\circ\text{C}$	
		25°C to MAX	5	25	15	50		
I_{IB} Input bias current	See Note 4	25°C	7	15	7	20	μA	
		MIN	12	25	9	30		
$I_{IH(S)}$ High-level strobe current	$V_{(\text{strobe})} = 5\text{ V}$, $V_{ID} = -5\text{ mV}$	25°C	± 100		± 100		μA	
$I_{IL(S)}$ Low-level strobe current	$V_{(\text{strobe})} = -100\text{ mV}$, $V_{ID} = 5\text{ mV}$	25°C	-1	-2.5	-1	-2.5	mA	
V_{ICR} Common-mode input voltage range	$V_{CC-} = -7\text{ V}$	Full range	± 5		± 5		V	
V_{ID} Differential input voltage range		Full range	± 5		± 5		V	
A_{VD} Large-signal differential voltage amplification	No load, $V_O = 0\text{ to }2.5\text{ V}$	25°C	12.5	33	10	33	V/mV	
		Full range	10		8			
V_{OH} High-level output voltage	$V_{ID} = 5\text{ mV}$, $I_{OH} = 0$	Full range	4‡		5		V	
	$V_{ID} = 5\text{ mV}$, $I_{OH} = -5\text{ mA}$	Full range	2.5	3.6‡	2.5	3.6‡		
V_{OL} Low-level output voltage	$V_{ID} = -5\text{ mV}$, $I_{OL} = 0$	Full range	-1	-0.5‡	0‡	0‡	V	
	$V_{(\text{strobe})} = 0.3\text{ V}$, $V_{ID} = 5\text{ mV}$, $I_{OL} = 0$	Full range	-1	0‡	-1	0‡	V	
I_{OL} Low-level output current	$V_{ID} = -5\text{ mV}$, $V_O = 0$	25°C	2	2.4	1.6	2.4	mA	
		MIN	1	2.3	0.5	2.4		
		MAX	0.5	2.3	0.5	2.4		
r_o Output resistance	$V_O = 1.4\text{ V}$	25°C	200		200		Ω	
$CMRR$ Common-mode rejection ratio	$R_S \leq 200\ \Omega$	Full range	80	100‡	70	100‡	dB	
I_{CC+} Supply current from V_{CC+}	$V_{ID} = -5\text{ mV}$,	Full range	5.5‡		9		mA	
I_{CC-} Supply current from V_{CC-}	No load	Full range	-3.5‡		-7		mA	
P_D Total power dissipation		Full range	90‡		150		mW	

† Unless otherwise noted, all characteristics are measured with the strobe open. Full range (MIN to MAX) for TL510M is -55°C to 125°C and for the TL510C is 0°C to 70°C .

‡ These typical values are at $T_A = 25^\circ\text{C}$.

§ The algebraic convention, where the most-positive (least negative) limit is designated as maximum, is used in this data sheet for logic levels only, e.g., when 0 V is the maximum, the minimum limit is a more-negative voltage.

NOTE 4: These characteristics are verified by measurements at the following temperatures and output voltage levels: for TL510M, $V_O = 1.8\text{ V}$ at $T_A = -55^\circ\text{C}$, $V_O = 1.4\text{ V}$ at $T_A = 25^\circ\text{C}$, and $V_O = 1\text{ V}$ at $T_A = 125^\circ\text{C}$; for TL510C, $V_O = 1.5\text{ V}$ at $T_A = 0^\circ\text{C}$, $V_O = 1.4\text{ V}$ at 25°C , and $V_O = 1.2\text{ V}$ at $T_A = 70^\circ\text{C}$. These output voltage levels were selected to approximate the logic threshold voltages of the types of digital logic circuits these comparators are intended to drive.

4

Voltage Comparators

TYPES TL510M, TL510C DIFFERENTIAL COMPARATORS WITH STROBE

switching characteristics, $V_{CC+} = 12\text{ V}$, $V_{CC-} = -6\text{ V}$, $T_A = 25^\circ\text{C}$

PARAMETER	TEST CONDITIONS			MIN	TYP	MAX	UNIT
Response time	$R_L = \infty$	$C_L = 5\text{ pF}$	See Note 5		30	80	ns
Strobe release time	$R_L = \infty$	$C_L = 5\text{ pF}$	See Note 6		5	25	ns

NOTES: 5. The response time specified is for a 100-mV input step with 5-mV overdrive.

6. For testing purposes, the input bias conditions are selected to produce an output voltage of 1.4 V. A 5-mV overdrive is then added to the input bias voltage to produce an output voltage that rises above 1.4 V. The time interval is measured from the 50% point of the strobe voltage curve to the point where the overdriven output voltage crosses the 1.4 V level.

TYPICAL CHARACTERISTICS

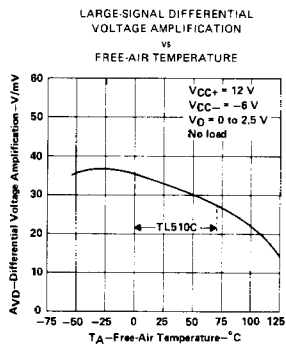

FIGURE 1

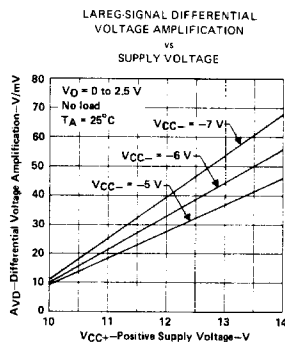

FIGURE 2

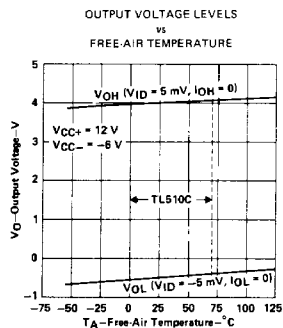

FIGURE 3

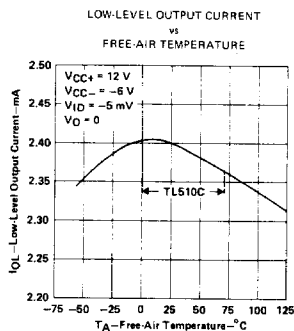

FIGURE 4

4

Voltage Comparators

TYPICAL CHARACTERISTICS

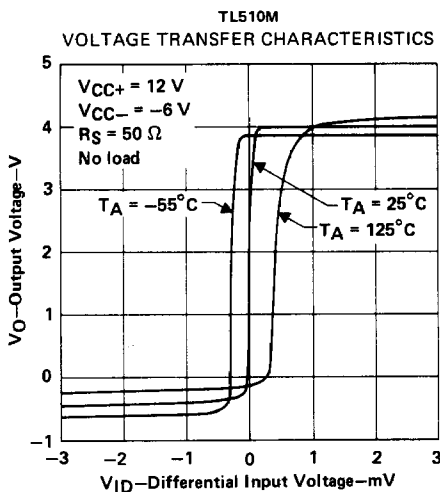

FIGURE 5

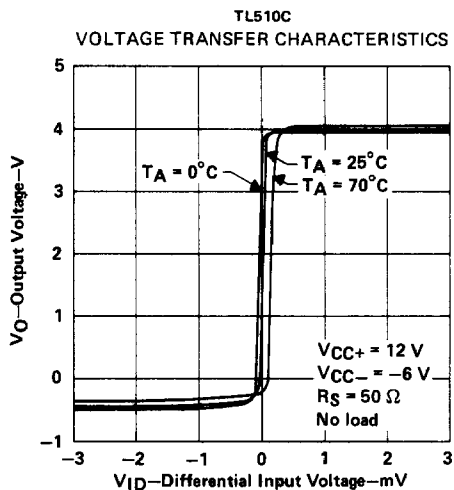

FIGURE 6

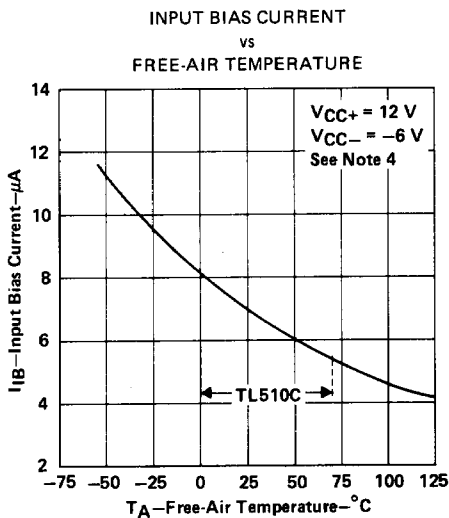

FIGURE 7

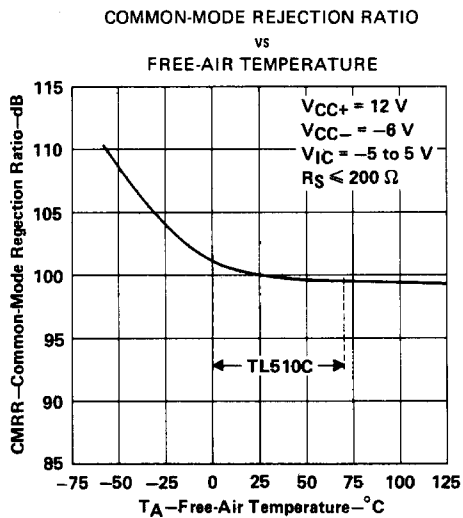

FIGURE 8

4

Voltage Comparators

TYPES TL510M, TL510C
DIFFERENTIAL COMPARATORS WITH STROBE

TYPICAL CHARACTERISTICS

**OUTPUT RESPONSE FOR
 VARIOUS INPUT OVERDRIVES**

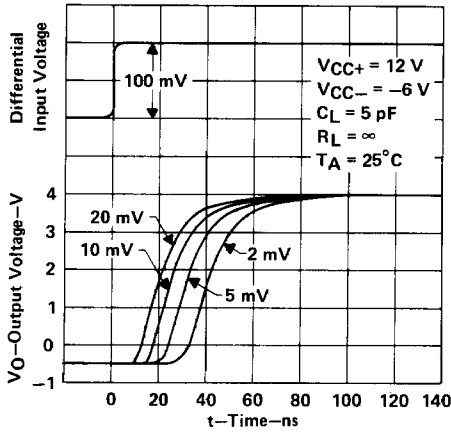

FIGURE 9

**STROBE RELEASE TIME
 FOR VARIOUS INPUT OVERDRIVES**

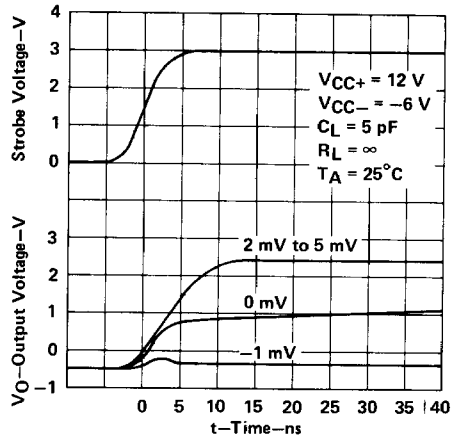

FIGURE 10

COMMON-MODE PULSE RESPONSE

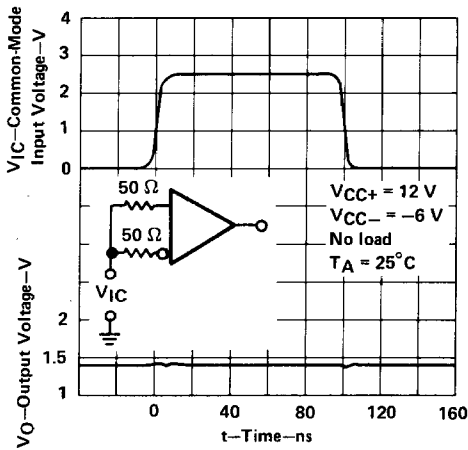

FIGURE 11

**TOTAL POWER DISSIPATION
 vs
 FREE-AIR TEMPERATURE**

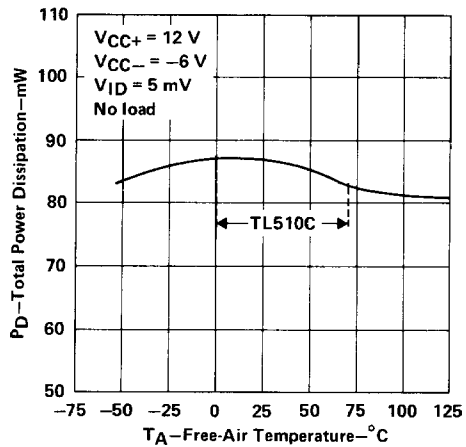

FIGURE 12

4

Voltage Comparators