



Low-Profile, 5V/12V or Adjustable, Step-Up DC-DC Converters for Flash Memory/PCMCIA Cards

General Description

The MAX606/MAX607 are the smallest CMOS, step-up DC-DC converters available for flash memory and PC (PCMCIA) cards. They switch at up to 1MHz, permitting the entire circuit to fit in 0.25in², yet remain under 1.35mm high to fit Type 1, 2, and 3 card standards. These devices operate from a 3V to 5.5V input and provide a $\pm 4\%$ accurate output that is preset to 5V or 12V, or adjustable from V_{IN} to 12.5V. They can provide up to 180mA of output current at 5V.

The MAX606 switches at up to 1MHz and fits Type 1 (thinnest standard) flash memory and PCMCIA cards. It uses a thin, 1.19mm high, 5 μ H inductor and small, 0.68 μ F output capacitors. The entire circuit fits in 0.25in² and is less than 1.35mm high.

The MAX607 switches at up to 500kHz, fitting Type 2 and 3 cards, as well as hand-held devices where height requirements are not as critical. It uses less board area than the MAX606, fitting in 0.16in², but requires 2.5mm of height. It also has a lower no-load supply current than the MAX606.

Both devices use a unique control scheme that optimizes efficiency over all input and output voltages. Other features include 1 μ A logic-controlled shutdown and user-controlled soft-start to minimize inrush currents.

The MAX606/MAX607 come in 8-pin μ MAX and SO packages. The μ MAX package uses half the board area of a standard 8-pin SO and has a maximum height of just 1.11mm.

Applications

- PCMCIA Cards
- Memory Cards
- Single PCMCIA Slot Programming
- Digital Cameras
- Flash Memory Programming
- Hand-Held Equipment

Pin Configuration

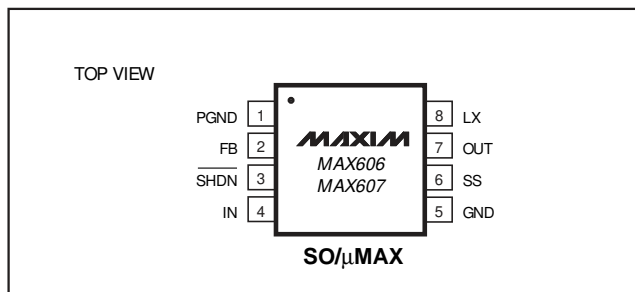

Features

- ◆ Lowest-Height Circuit (1.35mm max)
- ◆ $\pm 4\%$ Regulated Output (5V, 12V, or Adjustable)
- ◆ Up to 180mA Load Current
- ◆ 1MHz Switching Frequency (MAX606)
- ◆ 1 μ A Logic-Controlled Shutdown
- ◆ 3V to 5.5V Input Voltage Range
- ◆ Compact 8-Pin μ MAX Package

Ordering Information

PART	TEMP. RANGE	PIN-PACKAGE
MAX606ESA	-40°C to +85°C	8 SO
MAX606EUA	-40°C to +85°C	8 μ MAX
MAX607ESA	-40°C to +85°C	8 SO
MAX607EUA	-40°C to +85°C	8 μ MAX

Typical Operating Circuit

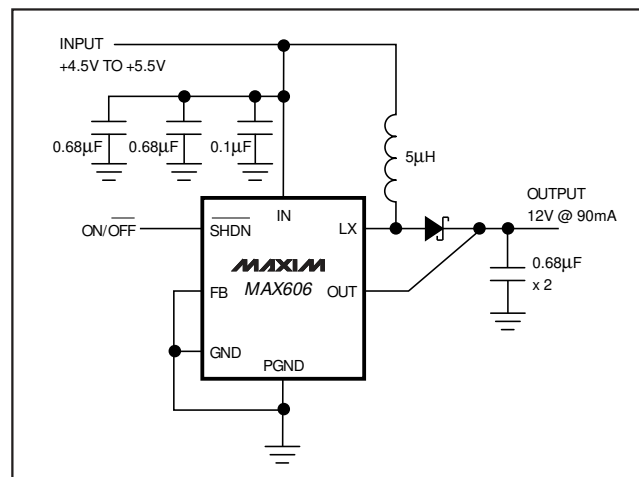

Low-Profile, 5V/12V or Adjustable, Step-Up DC-DC Converters for Flash Memory/PCMCIA Cards

ABSOLUTE MAXIMUM RATINGS

IN to GND	-0.3V to +6V	Continuous Power Dissipation (T _A = +70°C)
LX, OUT to GND	-0.3V to +15V	μMAX (derate 4.10mW/°C above +70°C)
PGND to GND	±0.3V	SO (derate 5.88mW/°C above +70°C)
FB to GND	-0.3V to (V _{CC} + 0.3V)	Operating Temperature Range
SS, SHDN to GND	-0.3V to +6V	Storage Temperature
		Lead Temperature (soldering, 10sec)

Stresses beyond those listed under "Absolute Maximum Ratings" may cause permanent damage to the device. These are stress ratings only, and functional operation of the device at these or any other conditions beyond those indicated in the operational sections of the specifications is not implied. Exposure to absolute maximum rating conditions for extended periods may affect device reliability.

ELECTRICAL CHARACTERISTICS

(V_{IN} = 3.3V, GND = PGND = FB = 0V, SHDN = IN, T_A = 0°C to +85°C, unless otherwise noted. Typical values are at T_A = +25°C.)

PARAMETER	CONDITIONS	MIN	TYP	MAX	UNITS	
Supply Voltage		3.0		5.5	V	
Undervoltage Lockout Threshold			2.4	2.8	V	
Output Voltage (Note 1)	3V < V _{IN} < 5V, FB = IN, I _{LOAD} = 0 to 180mA	4.8	5.0	5.2	V	
	4.5V < V _{IN} < 5.5V, FB = GND, I _{LOAD} = 0 to 120mA	11.5	12.0	12.5		
FB Regulation Setpoint	0.1V < V _{FB} < (V _{IN} - 0.1V)	1.96	2.00	2.04	V	
Adjustable Output Voltage Range	0.1V < V _{FB} < (V _{IN} - 0.1V)	V _{IN}		12.5	V	
Line Regulation	V _{IN} = 3V to 5.5V		0.5		%	
Switch On-Resistance			0.4	1	Ω	
Switch Off-Leakage	V _{LX} = 12V			10	μA	
Switch Current Limit		0.7		1.1	A	
SS Resistance	V _{SHDN} = V _{IN} , V _{SS} = 150mV	30	45	60	kΩ	
	V _{SHDN} = V _{SS} = 0			0.5		
Quiescent Supply Current	V _{OUT} = 13V	MAX606	250	500	μA	
		MAX607	150	300		
Shutdown Quiescent Current	V _{SHDN} = 0, OUT = IN		0.01	10	μA	
OUT Input Current	V _{OUT} = 13V			80	μA	
Switch On-Time Constant (K)	3V < V _{IN} < 5.5V (t _{ON} = K / V _{IN})	MAX606	1.9	3.0	4.3	μs-A
		MAX607	3.8	6.0	8.6	
Switch Off-Time Ratio	2V < (V _{OUT} + 0.5V - V _{IN}) < 8V (see <i>Pulse-Frequency-Modulation Control Scheme</i> section)	0.3		0.7		
SHDN Input Low Voltage	V _{IN} = 3V			0.25V _{IN}	V	
SHDN Input High Voltage	V _{IN} = 5.5V	0.66V _{IN}			V	
SHDN Input Current	V _{SHDN} = 0 or V _{IN}			±1	μA	
FB Input Low Voltage	V _{IN} = 3V to 5.5V. For V _{FB} below this voltage, output regulates to 12V.			0.1	V	
FB Input High Voltage	V _{IN} = 3V to 5.5V. For V _{FB} above this voltage, output regulates to 5V.	V _{IN} - 0.1			V	
FB Input Current	V _{FB} = 2.05V, V _{OUT} = 13V			200	nA	

Low-Profile, 5V/12V or Adjustable, Step-Up DC-DC Converters for Flash Memory/PCMCIA Cards

MAX606/MAX607

ELECTRICAL CHARACTERISTICS

($V_{IN} = 3.3V$, $GND = PGND = FB = 0V$, $\overline{SHDN} = IN$, $T_A = -40^{\circ}C$ to $+85^{\circ}C$, unless otherwise noted.) (Note 2)

PARAMETER	CONDITIONS	MIN	TYP	MAX	UNITS
Supply Voltage		3.0		5.5	V
Undervoltage Lockout Threshold			2.4	2.8	V
Output Voltage (Note 1)	$3V < V_{IN} < 5V$, $FB = IN$, $I_{LOAD} = 0$ to $135mA$	4.75		5.25	V
	$4.5V < V_{IN} < 5.5V$, $FB = GND$, $I_{LOAD} = 0$ to $90mA$	11.4		12.6	
FB Regulation Setpoint	$0.1V < V_{FB} < (V_{IN} - 0.1V)$	1.94		2.06	V
Adjustable Output Voltage Range	$0.1V < V_{FB} < (V_{IN} - 0.1V)$	V_{IN}		12.5	V
Switch On-Resistance				1	Ω
Switch Off-Leakage	$V_{LX} = 12V$			10	μA
Switch Current Limit		0.55		1.25	A
SS Resistance	$V_{\overline{SHDN}} = V_{IN}$, $V_{SS} = 150mV$	30		60	$k\Omega$
	$V_{\overline{SHDN}} = V_{SS} = 0$			0.5	
Quiescent Supply Current	$V_{OUT} = 13V$	MAX606		500	μA
		MAX607		300	
Shutdown Quiescent Current	$V_{\overline{SHDN}} = 0$, $OUT = IN$			10	μA
OUT Input Current	$V_{OUT} = 13V$			85	μA
Switch On-Time Constant (K)	$3V < V_{IN} < 5.5V$ ($t_{ON} = K / V_{IN}$)	MAX606	1.8	4.5	$\mu s-V$
		MAX607	3.5	9.0	
Switch Off-Time Ratio	$2V < (V_{OUT} + 0.5V - V_{IN}) < 8V$ (see <i>Pulse-Frequency-Modulation Control Scheme</i> section)	0.3		0.7	
\overline{SHDN} Input Low Voltage	$V_{IN} = 3V$			$0.25V_{IN}$	V
\overline{SHDN} Input High Voltage	$V_{IN} = 5.5V$	$0.66V_{IN}$			V
\overline{SHDN} Input Current	$V_{\overline{SHDN}} = 0$ or V_{IN}			± 1	μA
FB Input Low Voltage	$V_{IN} = 3V$ to $5.5V$. For V_{FB} below this voltage, output regulates to $12V$.			0.1	V
FB Input High Voltage	$V_{IN} = 3V$ to $5.5V$. For V_{FB} above this voltage, output regulates to $5V$.	$V_{IN} - 0.1$			V
FB Input Current	$V_{FB} = 2.05V$, $V_{OUT} = 13V$			200	nA

Note 1: The load specification is guaranteed by DC parametric tests and is not production tested in circuit.

Note 2: Specifications to $-40^{\circ}C$ are guaranteed by design, not production tested.

Low-Profile, 5V/12V or Adjustable, Step-Up DC-DC Converters for Flash Memory/PCMCIA Cards

Typical Operating Characteristics

($V_{IN} = 3.3V$, $T_A = +25^\circ C$, unless otherwise noted.)

MAXIMUM OUTPUT CURRENT vs. INPUT VOLTAGE

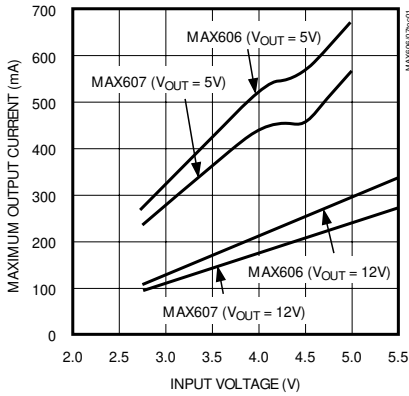

MAX606 EFFICIENCY vs. OUTPUT CURRENT

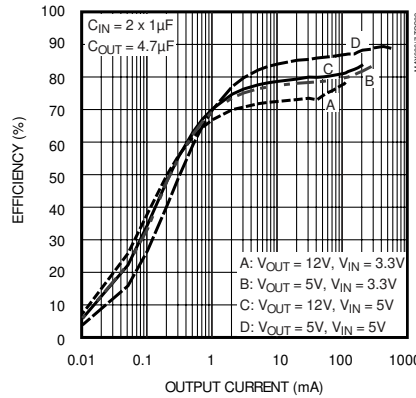

MAX607 EFFICIENCY vs. OUTPUT CURRENT

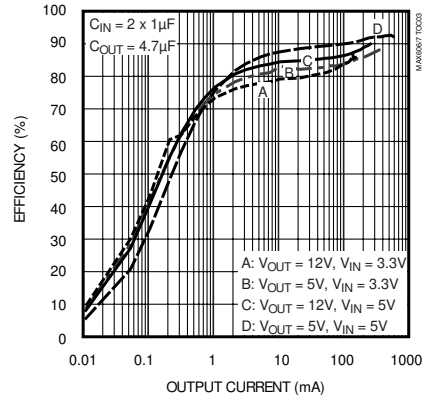

SHUTDOWN QUIESCENT CURRENT vs. TEMPERATURE

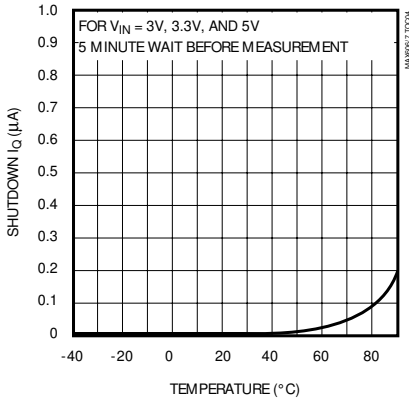

SWITCH ON-TIME vs. INPUT VOLTAGE

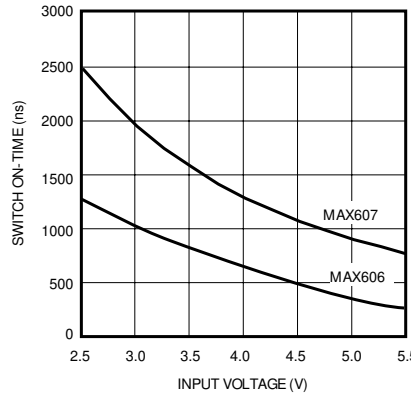

SWITCH OFF-TIME vs. OUTPUT VOLTAGE

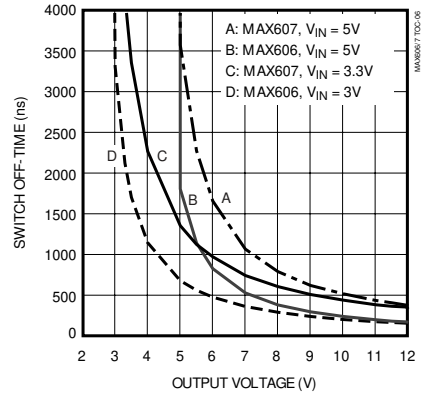

MAX606 NO-LOAD SUPPLY CURRENT vs. TEMPERATURE

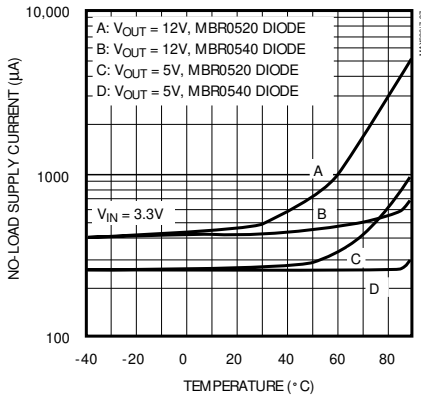

MAX607 NO-LOAD SUPPLY CURRENT vs. TEMPERATURE

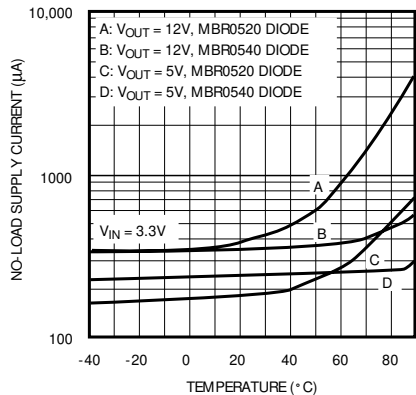

DIODE LEAKAGE CURRENT vs. TEMPERATURE

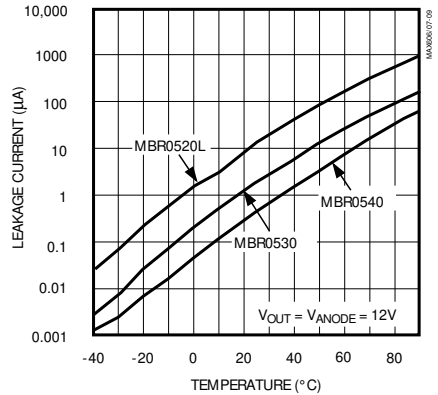

Low-Profile, 5V/12V or Adjustable, Step-Up DC-DC Converters for Flash Memory/PCMCIA Cards

Typical Operating Characteristics (continued)

($V_{IN} = 3.3V$, $T_A = +25^\circ C$, unless otherwise noted.)

MAX606/MAX607

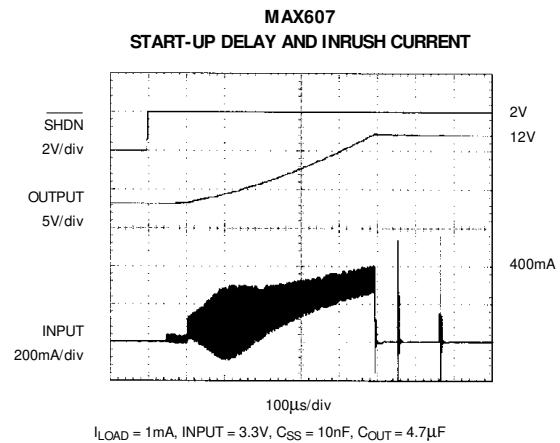
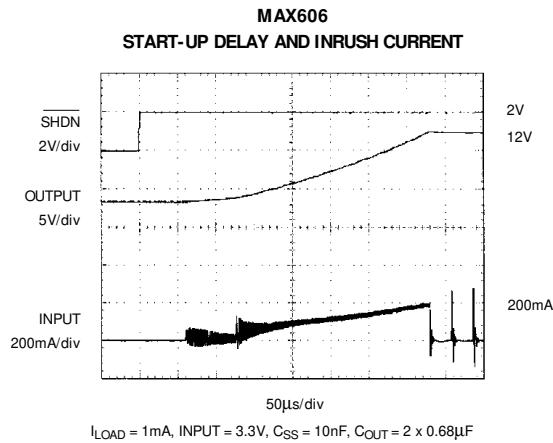
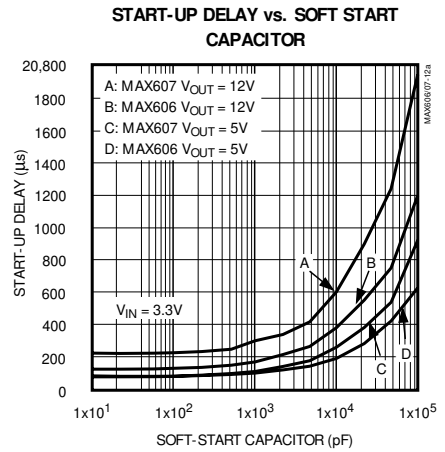
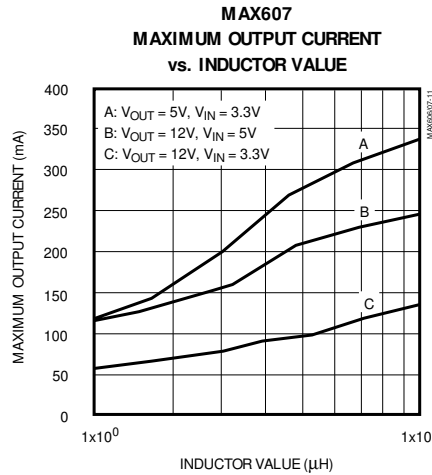
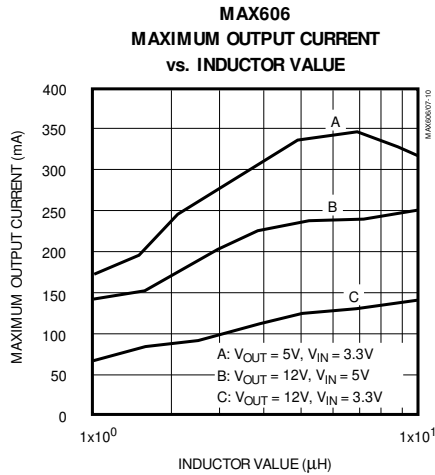

Low-Profile, 5V/12V or Adjustable, Step-Up DC-DC Converters for Flash Memory/PCMCIA Cards

Typical Operating Characteristics (continued)

($V_{IN} = 3.3V$, $T_A = +25^{\circ}C$, unless otherwise noted.)

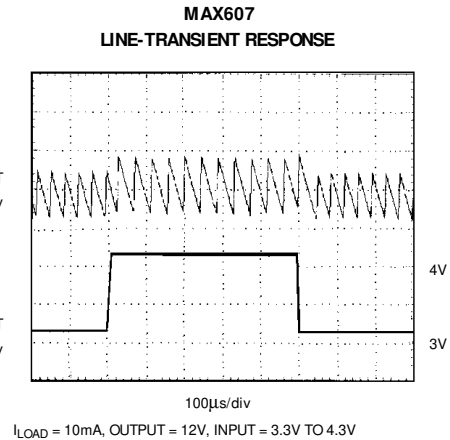
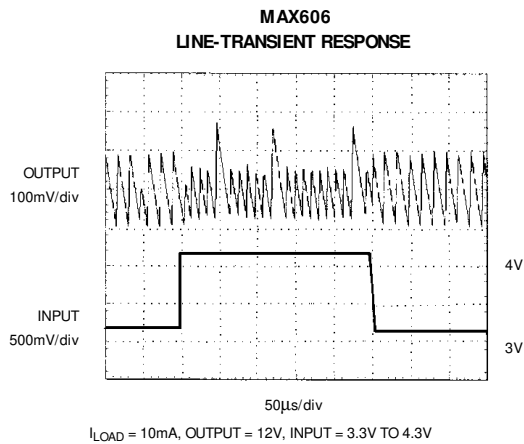
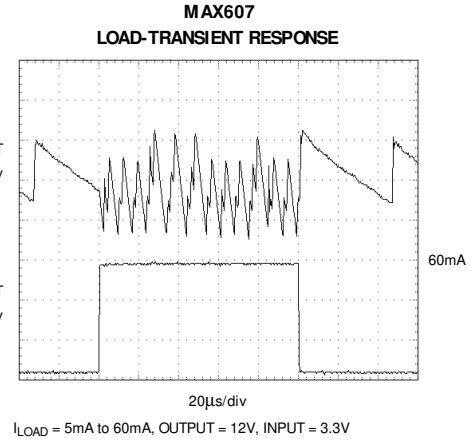
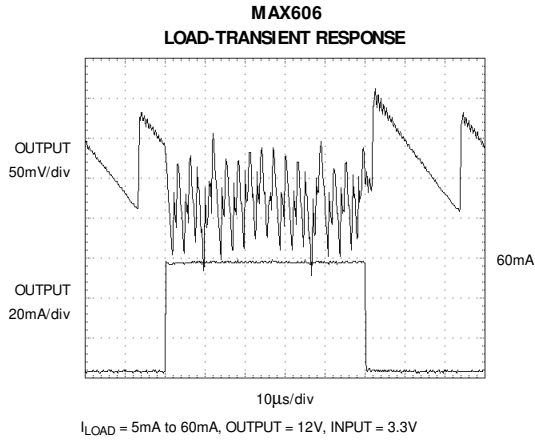

Low-Profile, 5V/12V or Adjustable, Step-Up DC-DC Converters for Flash Memory/PCMCIA Cards

Pin Description

MAX606/MAX607

PIN	NAME	FUNCTION
1	PGND	Power Ground. Source of n-channel power MOSFET.
2	FB	Feedback Input. Connect to IN for 5V output, to GND for 12V output, or to a resistive voltage divider between OUT and GND for an adjustable output between IN and 12.5V.
3	$\overline{\text{SHDN}}$	Shutdown Input, Active Low. Connect to GND to power down or to IN for normal operation. Output power FET is held off when $\overline{\text{SHDN}}$ is low.
4	IN	Supply Voltage Input: 3.0V to 5.5V
5	GND	Analog Ground
6	SS	Soft-Start Input
7	OUT	Output. Always connect directly to the circuit output.
8	LX	Drain of n-channel power MOSFET

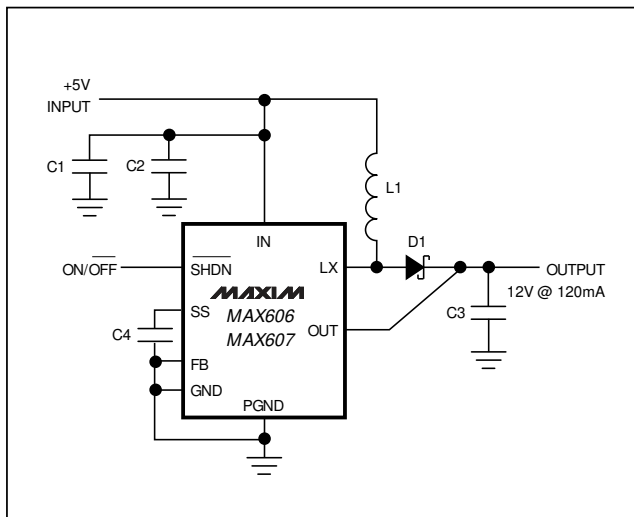

Figure 1. 12V Standard Application Circuit

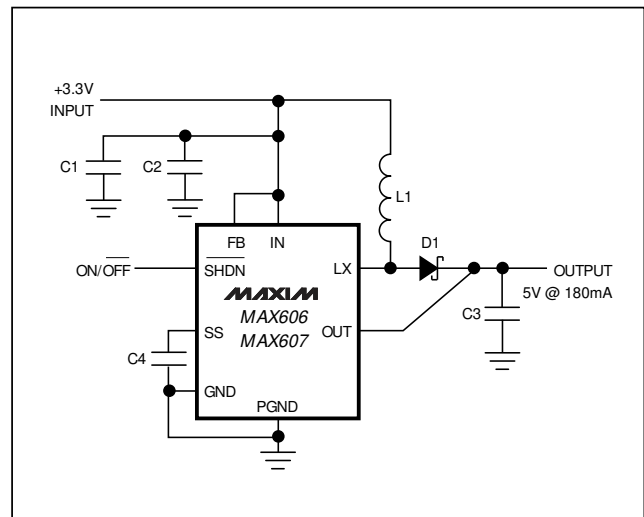

Figure 2. 5V Standard Application Circuit

Standard Application Circuits

This data sheet provides two predesigned standard application circuits. The circuit of Figure 1 produces 12V at 120mA from a 5V input. Table 1 lists component values and part numbers for both the MAX606 and MAX607 variations of this circuit. The circuit of Figure 2 produces

5V at a typical output current of 180mA from a 3.3V input. Each application circuit is designed to deliver the full rated output load current over the temperature range listed. Component values and part numbers for this circuit are listed in Table 2. See Table 3 for component suppliers' phone and fax numbers.

Low-Profile, 5V/12V or Adjustable, Step-Up DC-DC Converters for Flash Memory/PCMCIA Cards

Table 1. Suggested Components for 12V Standard Application Circuit of Figure 2

DESIGNATION	MAX606	MAX607
L1	5 μ H inductor Dale ILS-3825-XX	10 μ H inductor Sumida CLS62-100
D1	0.5A, 20V diode Motorola MBR0520L	0.5A, 20V diode Motorola MBR0520L
C1	0.1 μ F ceramic cap.	0.1 μ F ceramic cap.
C2	2 x 0.68 μ F ceramic cap. Marcon THCR20E1E684Z	2.2 μ F ceramic cap. Marcon THCR30E1E225M
C3	2 x 0.68 μ F ceramic cap. Marcon THCR20E1E684Z	2 x 1 μ F ceramic cap. Marcon THCR30E1E105M
C4	10nF ceramic cap.	10nF ceramic cap.

Table 2. Suggested Components for 5V Standard Application Circuit of Figure 1

DESIGNATION	MAX606	MAX607
L1	5 μ H, 1A inductor Dale ILS-3825-XX	10 μ H, 0.7A inductor Sumida CLS62B-100
D1	0.5A, 20V diode Motorola MBR0520L	0.5A, 20V diode Motorola MBR0520L
C1	0.1 μ F ceramic cap.	0.1 μ F ceramic cap.
C2	2 x 0.68 μ F ceramic cap. Marcon THCR20E1E684Z	2.2 μ F ceramic cap. Marcon THCR30E1E225M
C3	4.7 μ F ceramic cap. Marcon THCR30E1E475M	4.7 μ F ceramic cap. Marcon THCR30E1E475M
C4	10nF ceramic cap.	10nF ceramic cap.

Detailed Description

The remainder of this document contains the detailed information you'll need to design a circuit that differs from the two Standard Application Circuits. If you are using one of the predesigned circuits, the following sections are purely informational.

The MAX606/MAX607 CMOS, step-up DC-DC converters employ a current-limited pulse-frequency control scheme. This control scheme regulates a boost topology to convert input voltages between 3V and 5.5V into either a pin-programmable 5V/12V output, or an adjustable output between V_{IN} and 12.5V. It optimizes performance over all input and output voltages, and guarantees output accuracy to $\pm 4\%$.

The ultra-high switching frequency (typically 1MHz for the MAX606 and 0.5MHz for the MAX607) permits the use of extremely small external components, making these converters ideal for use in Types 1, 2, and 3 flash memory and PCMCIA applications.

Pulse-Frequency-Modulation Control Scheme

The MAX606/MAX607 employ a proprietary, current-limited control scheme that combines the ultra-low supply current of traditional pulse-skipping converters with the high full-load efficiency of current-mode pulse-width-modulation converters. This particular control scheme is similar to the one used in previous current-limited devices (which governed the switching current

Table 3. Component Suppliers

SUPPLIER	PHONE	FAX
Dale Inductors	605-668-4131	605-665-1627
Marcon/United Chemi-Con	708-696-2000	708-518-9985
Motorola	602-244-3576	602-244-4015
Sumida USA	708-956-0666	708-956-0702
Sumida Japan	03-607-5111	03-607-5144

via maximum on-time, minimum off-time, and current limit), except it varies the on and off times according to the input and output voltages. This important feature enables the MAX606/MAX607 to achieve ultra-high switching frequencies while maintaining high output accuracy, low output ripple, and high efficiency over a wide range of loads and input/output voltages.

Figure 3 shows the functional diagram of the MAX606/MAX607. The internal power MOSFET is turned on when the error comparator senses that the output is out of regulation. The power switch stays on until either the timing circuit turns it off at the end of the on-time, or the switch current reaches the current limit. Once off, the switch remains off during the off-time. Subsequently, if the output is still out of regulation, another switching cycle is initiated. Otherwise, the switch remains turned off as long as the output is in regulation.

Low-Profile, 5V/12V or Adjustable, Step-Up DC-DC Converters for Flash Memory/PCMCIA Cards

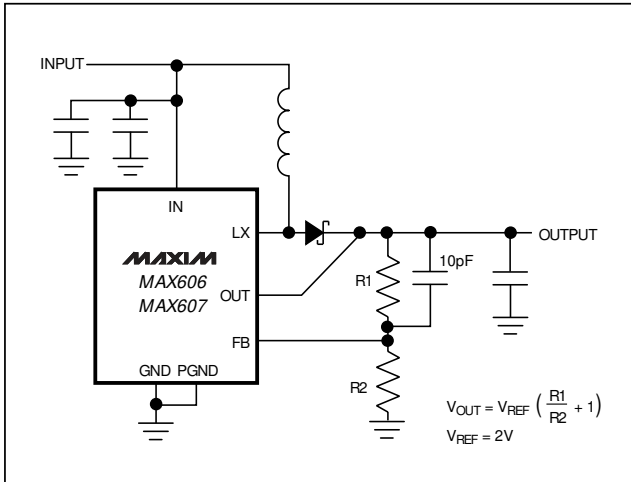

Figure 4. Adjustable Output Voltage

When FB is connected to IN or GND, an internal voltage divider is configured to produce a predetermined output. However, when the voltage at FB is between 0.1V above ground and 0.1V below V_{IN} , the device is in the adjustable output mode. In this mode, the MAX606/MAX607 output voltage is set by two external resistors, R1 and R2 (Figure 4), which form a voltage divider between the output and FB. Use the following equation to determine the output voltage:

$$V_{OUT} = V_{REF} \left(\frac{R1}{R2} + 1 \right)$$

where $V_{REF} = 2V$. To simplify the resistor selection:

$$R1 = R2 \left[\left(\frac{V_{OUT}}{V_{REF}} \right) - 1 \right]$$

Since the input current at FB is 200nA maximum, large values (up to 100k Ω) can be used for R2 with no significant loss of accuracy. For 1% error, the current through R2 should be at least 100 times the FB input bias current.

Soft-Start

Connecting a capacitor to the Soft-Start (SS) pin ensures a gradually increasing current limit during power-up or when exiting shutdown, thereby reducing initial inrush currents. This feature can be useful, for example, when an old battery's increased series resistance limits initial inrush currents. Using the soft-start feature in a situation like this minimizes the risk of overloading the incoming supply.

Soft-start timing is controlled by the value of the SS capacitor. On power-up, the SS capacitor is charged by the 2V reference through an internal, 45k Ω pull-up resistor. As the voltage on the SS pin increases, the voltage at the SS clamp output also increases, which in turn raises the current-limit threshold. The Start-Up Delay vs.

SS Capacitor graph in the *Typical Operating Characteristics* shows typical timing characteristics for selected capacitor values and circuit conditions. The soft-start capacitor is discharged each time the MAX606 or MAX607 is put into shutdown, including during under-voltage lockout and when powering down at IN.

If the circuit is required to start up with no load, as in flash memory programming supplies, soft-start is not required. Omitting the soft-start capacitor permits a minimum output voltage rise time from the shutdown state, improving flash memory access time.

Undervoltage Lockout

The MAX606/MAX607 monitor the supply voltage at IN and operate for supply voltages greater than 2.8V. When an undervoltage condition is detected, control logic turns off the output power FET and discharges the soft-start capacitor to ground. The control logic holds the output power FET in an off state until the supply voltage rises above the undervoltage threshold, at which time a soft-start cycle begins.

Shutdown Mode

Connecting \overline{SHDN} to GND will hold the MAX606/MAX607 in shutdown mode. In shutdown, the output power FET is off, but there is still an external path from IN to the load via the inductor and diode. The internal reference capacitor also turns off, which causes the soft-start capacitor to discharge. Typical device standby current in shutdown mode is 0.01 μA . For normal operation, connect \overline{SHDN} to IN. A soft-start cycle is initiated when the MAX606/MAX607 exit shutdown.

Applications Information

Inductor Selection

Use a 5 μH inductor for the MAX606 and a 10 μH inductor for the MAX607. See Table 3 for a list of component suppliers. Higher inductor values allow greater load currents due to operation in continuous-conduction mode, while lower inductor values lead to smaller physical size due to lower energy-storage requirements and lower output-filter-capacitor requirements. Potential drawbacks of using lower inductor values are increased output ripple, lower efficiency, and lower output-current capability due to operation in discontinuous-conduction mode. (See the Maximum Output Current vs. Inductor Value graph in the *Typical Operating Characteristics*.)

The inductor must have a saturation (incremental) current rating equal to the peak switch-current limit, which is 1.1A. For highest efficiency, minimize the inductor's DC resistance.

Low-Profile, 5V/12V or Adjustable, Step-Up DC-DC Converters for Flash Memory/PCMCIA Cards

Diode Selection

The MAX606/MAX607's high switching frequency demands a high-speed rectifier. Use a Schottky diode with at least a 0.5A average current rating and a 1.2A peak current rating, such as an MBR0520L. See Table 3 for a list of component suppliers.

Capacitor Selection

Output Filter Capacitor

The output voltage ripple is a function of the output capacitor's equivalent series resistance (ESR) and capacitance. For best performance, use ceramic capacitors. Higher-ESR capacitors, such as tantalums, will cause excessive ripple. See Table 3 for a list of component suppliers.

The output voltage ripple is approximately 100mVp-p for the 12V Standard Application Circuit (Figure 1) and 50mV for the 5V circuit (Figure 2). To further reduce this ripple, or to reduce the ripple on a different application circuit, increase the value of the output filter capacitor. If this capacitor is low ESR (e.g., ceramic), the output voltage ripple will be dominated by this capacitance.

Input Bypass Capacitors

For applications where the MAX606/MAX607 are physically close to the input supply's filter capacitor (e.g., in PCMCIA drivers from the host computer), the input bypass capacitor may not be necessary.

In other applications where the MAX606/MAX607 are more than a few inches away from the supply (such as memory cards), the input bypass capacitor is needed to reduce reflected current ripple to the supply and improve efficiency by creating a low-impedance path for the ripple current. Under these circumstances, the associated high Q and low ESR of ceramic capacitors do not diminish the problem. Therefore, include some low-Q, moderate-ESR capacitance (e.g., tantalum) at the input in order to reduce ringing.

Layout

The MAX606/MAX607's high-frequency operation and high peak currents make PC board layout critical to minimize ground bounce and noise. Locate input bypass and output filter capacitors as close to the device pins as possible. All connections to OUT (and to FB when operating in adjustable-output mode) should also be kept as short as possible. A ground plane is recommended. Solder GND and PGND directly to the ground plane. Refer to the MAX606/MAX607 evaluation kit manual for a suggested surface-mount layout.

Chip Topography

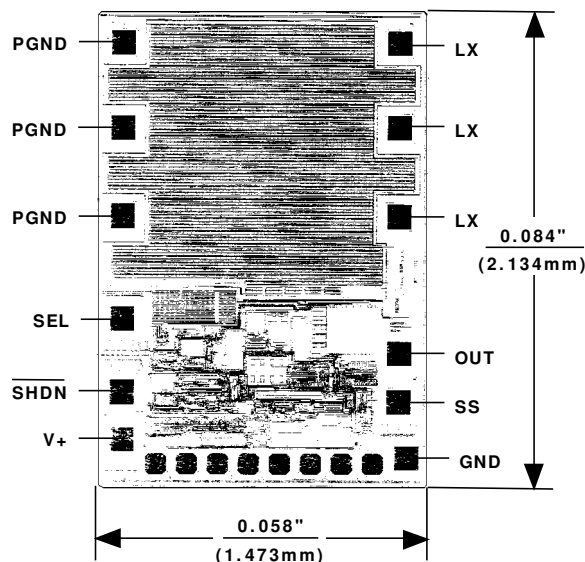

TRANSISTOR COUNT: 613

SUBSTRATE CONNECTED TO GND

MAX606/MAX607

Low-Profile, 5V/12V or Adjustable, Step-Up DC-DC Converters for Flash Memory/PCMCIA Cards

Package Information

8LUMAXD.ERS

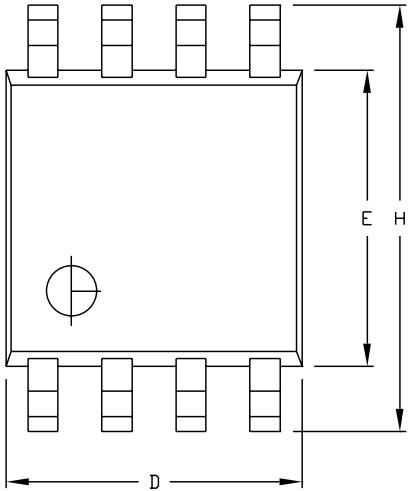

	INCHES		MILLIMETERS		JEDEC			
	MIN	MAX	MIN	MAX	MIN	MAX	MIN	MAX
A	0.037	0.043	0.94	1.10	---	0.043	---	1.10
A1	0.002	0.006	0.05	0.15	0.002	0.006	0.05	0.15
B	0.010	0.014	0.25	0.36	0.010	0.016	0.25	0.40
C	0.005	0.007	0.13	0.18	0.005	0.009	0.13	0.23
D	0.116	0.120	2.95	3.05	0.114	0.122	2.9	3.1
e	0.0256	BSC	0.65	BSC	0.0256	BSC	0.64	BSC
E	0.116	0.120	2.95	3.05	0.114	0.122	2.9	3.1
H	0.188	0.198	4.78	5.03	0.193	BSC	4.9	BSC
L	0.016	0.026	0.41	0.66	0.016	0.027	0.40	0.70
α	0°	6°	0°	6°	0°	6°	0°	6°

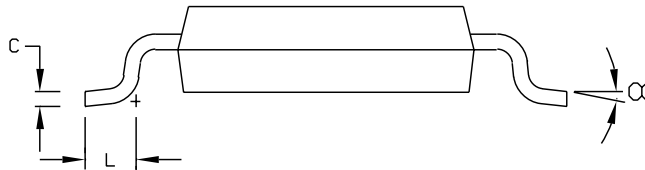
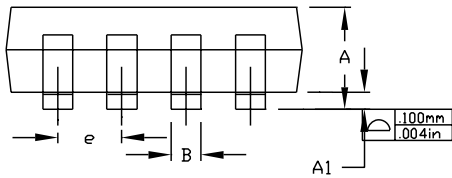

NOTES:

1. D&E DO NOT INCLUDE MOLD FLASH.
2. MOLD FLASH OR PROTRUSIONS NOT TO EXCEED .15mm(.006").
3. CONTROLLING DIMENSION: MILLIMETERS.
4. MEETS JEDEC MO-187.

MAXIM
 PROPRIETARY INFORMATION
 TITLE:
 8L uMAX PACKAGE OUTLINE DWG.
 APPROVAL: DOCUMENT CONTROL NO. 21-0036 REV F 1/1