



MS2553C

35 Watts, 50 Volts

Pulsed Avionics 1025 to 1150 MHz

GENERAL DESCRIPTION

The MS2553C is a medium power COMMON BASE bipolar transistor. It is designed for pulsed systems in the frequency band 1025-1150 MHz. The device has gold thin-film metallization and diffused ballasting for proven highest MTTF. The transistor includes input prematch for broadband capability. Low thermal resistance package reduces junction temperature, extends life.

**CASE OUTLINE
M220
(Common Base)**

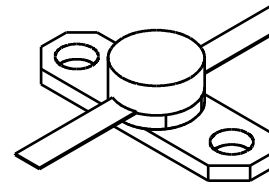

ABSOLUTE MAXIMUM RATINGS

Power Dissipation

Device Dissipation @25°C (P_d) 175 W (At rated pulse condition)

Voltage and Current

Collector to Base Voltage (BV_{ces}) 65 V

Emitter to Base Voltage (BV_{ebo}) 3.5 V

Collector Current (I_c) 4.0 A

Temperatures

Storage Temperature -65 to +150 °C

Operating Junction Temperature +200 °C

ELECTRICAL CHARACTERISTICS @ 25°C

SYMBOL	CHARACTERISTICS	TEST CONDITIONS	MIN	TYP	MAX	UNITS
BV _{EBO}	Emitter - Base Breakdown	I _e = 10mA	3.5			V
BV _{CBO}	Collector - Base Breakdown	I _c = 20mA	65			V
BV _{CEO}	Collector - Emitter Breakdown	I _c = 20mA	25			V
h _{FE}	DC - Current Gain	I _c = 500mA, V _{ce} = 5V	20			-
θ _{jc} ^{1,2}	Thermal Resistance				0.5	°C/W

FUNCTIONAL CHARACTERISTICS @ 25°C, V_{cc} = 50V

P _{OUT}	Power Out	F = 1025/1090/1150 MHz, PW = 10μsec, DF = 1%, P _{IN} = 3.2W	35			W
P _{IN}	Power Input				3.2	W
G _p	Power Gain		10.5			dB
η _c	Collector Efficiency		40			%
P _d	Pulse Droop				1	dB
?	Load Mismatch				10:1	-

NOTES: 1. At rated output power and pulse conditions

2. Pulse Format: PW=10μs, DF=1%

Rev. A - May. 2008

Microsemi reserves the right to change, without notice, the specifications and information contained herein.
Visit our web site at www.microsemi.com or contact our factory direct.

Typical Performance (1025MHz ~ 1150MHz)

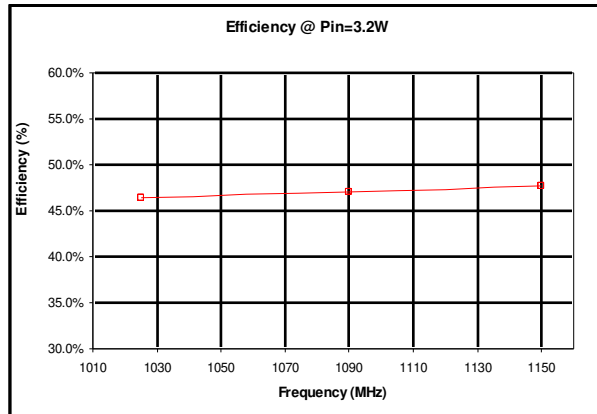
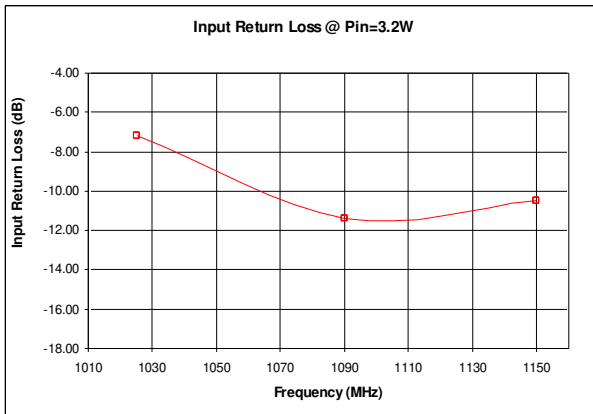
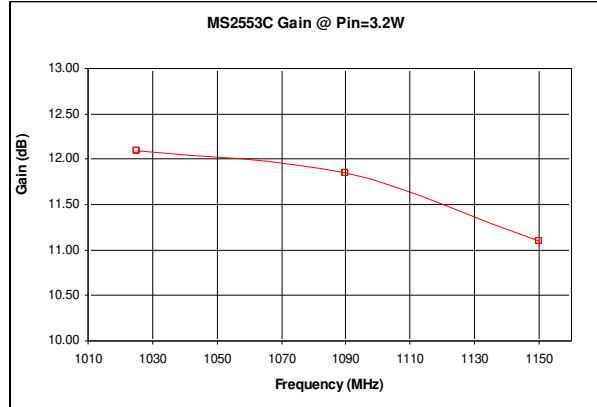
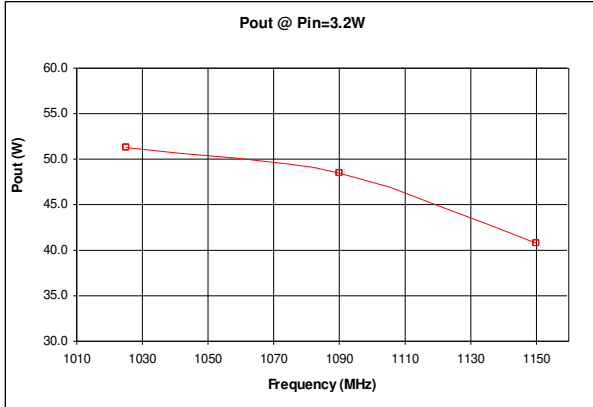

MS2553C Test Circuit Layout

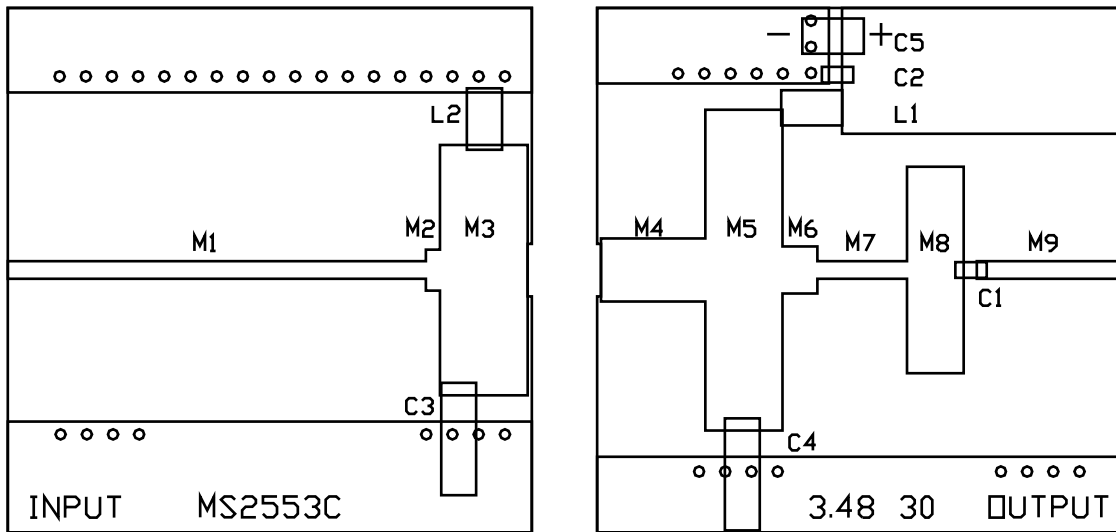

MS2553C Test Circuit Component Designations and Values

Part	Description	Part	Description
C1, C2	100pF Chip Capacitor (ATC 100B)	C3, C4	.35-3.5pF Johanson Capacitor, JMC5801
C5	220uF 63V Electrolytic Capacitor	L1, L2	4 Turns, 20 AWG, IDIA 0.092"φ
M1	67 x 1596 mils (W x L)	M2	156 x 54 mils (W x L)
M3	955 x 335 mils (W x L)	M4	240 x 398 mils (W x L)
M5	1224 x 294 mils (W x L)	M6	180 x 134 mils (W x L)
M7	67 x 342 mils (W x L)	M8	788 x 216 mils (W x L)
M9	67 x 551 mils (W x L)	PCB	Rogers RO4350, $\epsilon_r=3.48$, 30mils, 1oz

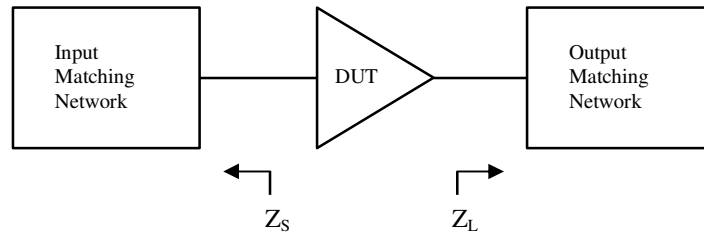
Typical Impedance Values

Frequency (MHz)	Z_S (?S)	Z_L (?S)
1025	6.3 - j15.4	6.6 + j2.0
1090	5.6 - j14.5	7.6 + j2.6
1150	5.1 - j13.8	8.6 + j2.7

* $V_{CC} = 50V$, $P_{IN} = 3.2W$

* Pulse Format: 10 μ s, 1% Long Term Duty Factor

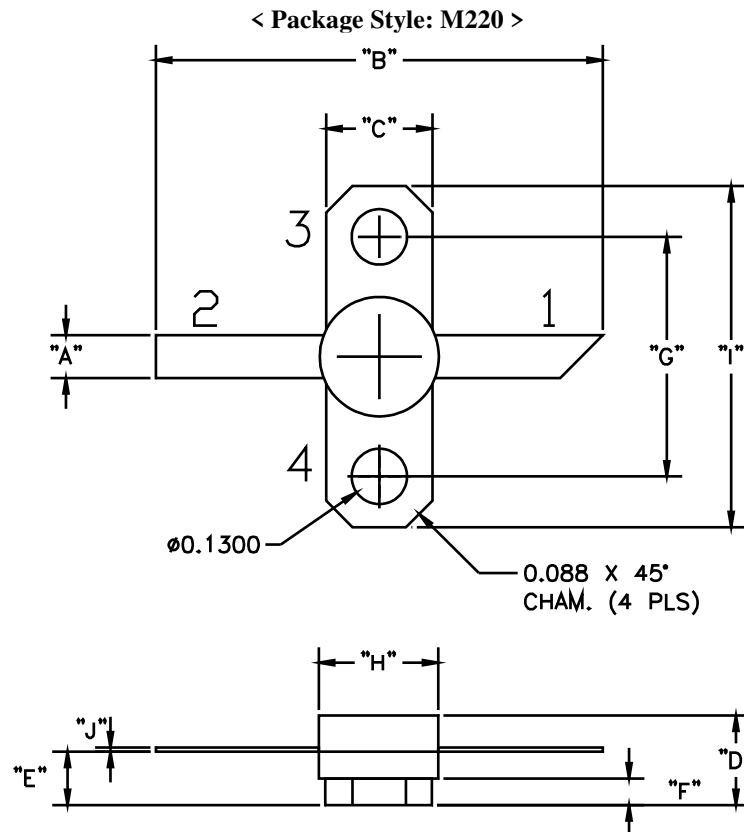
Package Mechanical Data

DIMENSION					
	MINIMUM INCHES/MM	MAXIMUM INCHES/MM		MINIMUM INCHES/MM	MAXIMUM INCHES/MM
A	.100 / 2.54		B	1.050 / 26.67	-
C	.250 / 6.35		D	-	.210 / 5.33
E	.120 / 3.05	.130 / 3.30	F	.062 / 1.58	
G	.562 / 14.28		H	-	.285 / 7.24
I	.800 / 20.32		J	.003 / 0.08	.006 / 0.15
PIN CONNECTION					
1	COLLECTOR		2	EMITTER	
3	BASE		4	BASE	