

General Specifications

Electrical Capacity (Resistive Load)

Logic Level: 0.4VA maximum @ 28V AC/DC maximum
(Applicable Range 0.1mA ~ 0.1A @ 20mV ~ 28V)
Note: Find additional explanation of operating range in Supplement section.

Other Ratings

Contact Resistance: 80 milliohms maximum
Insulation Resistance: 500 megohms minimum @ 500V DC
Dielectric Strength: 500V AC minimum for 1 minute minimum
Mechanical Life: 50,000 operations minimum
Electrical Life: 50,000 operations minimum
Nominal Operating Force: 1.0N
Travel: Pretravel .020" (0.5mm); Overtravel .023 (0.6mm); Total Travel .043" (1.1mm)

Materials & Finishes

Actuator: Glass fiber reinforced polyamide (UL94V-0)
Case: Glass fiber reinforced polyamide (UL94V-0)
Movable Contacts: Phosphor bronze with gold plating
Stationary Contacts: Brass with gold plating
Base: Glass fiber reinforced polyamide (UL94V-0)
Mounting Bracket: Phosphor bronze with tin plating
Terminals: Brass with gold plating

Environmental Data

Operating Temperature Range: -25°C through +70°C (-13°F through +158°F)
Humidity: 90 ~ 95% humidity for 240 hours @ 40°C (104°F)
Vibration: 10 ~ 55Hz with peak-to-peak amplitude of 1.5mm traversing the frequency range & returning in 1 minute; 3 right angled directions for 2 hours
Shock: 50G (490m/s²) acceleration (tested in 6 right angled directions, with 5 shocks in each direction)

PCB Processing

Soldering: Wave Soldering Recommended: See Profile A in Supplement section.
Manual Soldering: See Profile A in Supplement section.
Cleaning: These devices are not process sealed. Hand clean locally using alcohol based solution.

Standards & Certifications

Flammability Standards: UL94V-0 actuator, case, & base
 The GB2 Series pushbuttons have not been tested for UL recognition or CSA certification. These switches are designed for use in a low-voltage, low-current, logic-level circuit. When used as intended in a logic-level circuit, the results do not produce hazardous energy.

Distinctive Characteristics

Unique, off-center actuator allows high density setup and easy actuation while avoiding accidental operation in compact environments.

Side-by-side, block mounting can be achieved by use of bracket AT546 on straight PC mounting types.

Off-Momentary On Circuit.

Black, white, and red snap-on caps available.

Extremely thin size allows high density PCB mounting and makes these switches ideal for handheld equipment.

Award-winning STC contact mechanism with benefits unavailable in conventional mechanisms: smoother, positive detent actuation, increased contact stability and unparalleled logic-level reliability. (Additional STC details in Terms & Acronyms; see Supplement section.)

Molded-in, epoxy sealed terminals lock out flux and other contaminants.

.100" x .100" (2.54mm x 2.54mm) terminal spacing conforms to standard PC board grid spacing for straight and angle mounting.

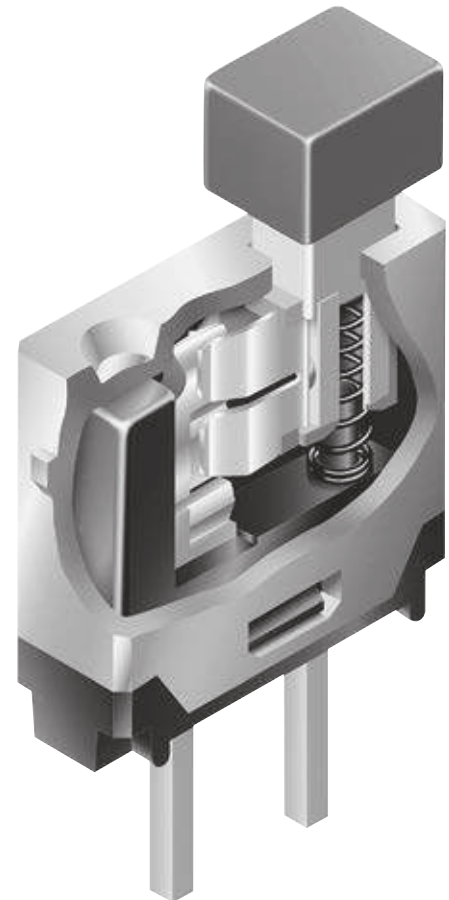

Actual Size

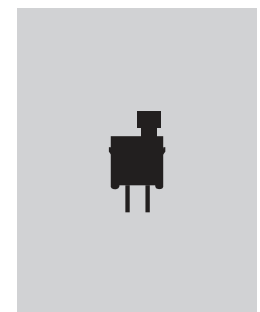

TYPICAL SWITCH ORDERING EXAMPLE

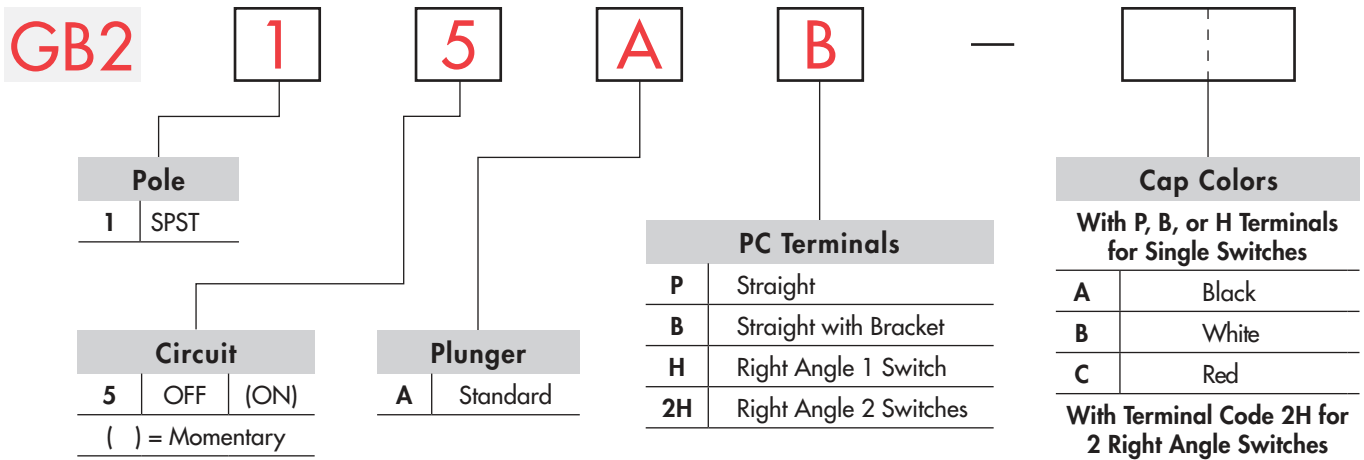

DESCRIPTION FOR TYPICAL ORDERING EXAMPLE

GB215AB

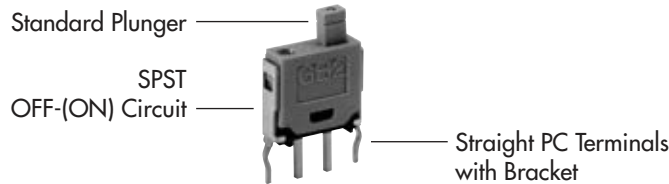

POLE & CIRCUIT

Pole	Model	Plunger Position () = Momentary		Connected Terminals		Throw & Schematics
		Normal	Down	Normal	Down	
SP	GB215	OFF	(ON)	OPEN	1-2 1-2 3-4	Note: Terminal numbers are not actually on the switch.

TYPICAL SWITCH DIMENSIONS

Straight PC



GB215AP

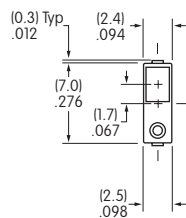

Single Pole

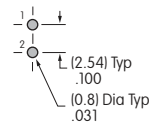
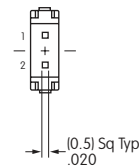
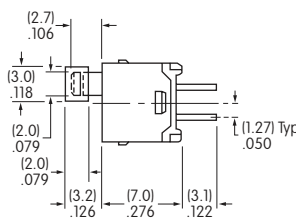

TYPICAL SWITCH DIMENSIONS

Single Pole

Straight PC with Bracket

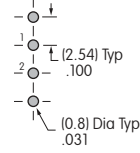
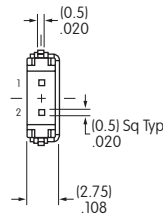
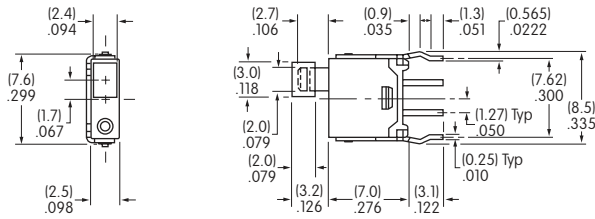

GB215AB

Single Pole with 1 Switch

Right Angle PC

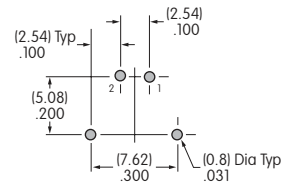
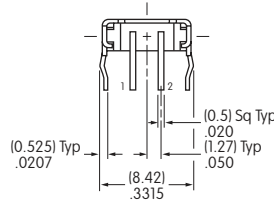
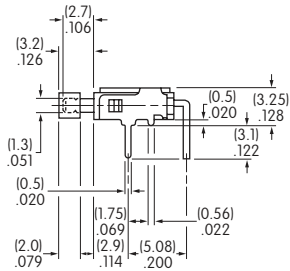
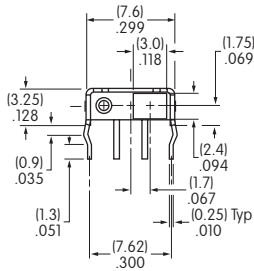

GB215AH

Single Pole with 2 Switches

Right Angle PC

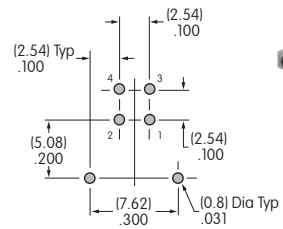
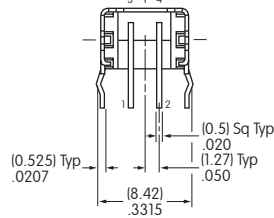
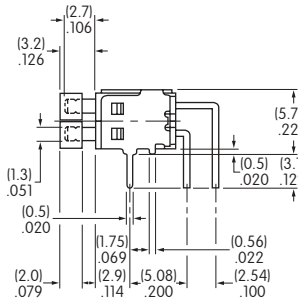
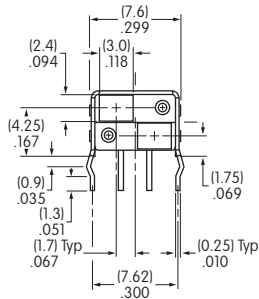

GB215A2H

SNAP-ON CAP & MOUNTING BRACKET

- A** AT4137 Rectangular Snap-on Cap Black
- B** AT4137 Rectangular Snap-on Cap White
- C** AT4137 Rectangular Snap-on Cap Red

Material: PBT
Finish: Glossy



Actual Size

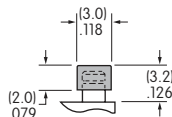

AT546
Mounting Bracket
for Block Mounting

Material:
Phosphor Bronze
with Tin Plating

