

## GHz NOISE SUPPRESSION CHIP FERRITE BEAD BLM15H□□□SN1□ REFERENCE SPECIFICATION

### 1. Scope

This reference specification applies to chip ferrite bead BLM15H\_SN series for general electronic equipment.

### 2. Part Numbering

(Ex.)

|            |      |                   |                 |                                      |             |          |                    |                     |
|------------|------|-------------------|-----------------|--------------------------------------|-------------|----------|--------------------|---------------------|
| BL         | M    | 15                | HG              | 601                                  | S           | N        | 1                  | D                   |
| Product ID | Type | Dimension (L × W) | Characteristics | Impedance (Typical value at 100 MHz) | Performance | Category | Numbers of circuit | Packaging D: taping |

### 3. Part Number and Rating

|                             |                 |
|-----------------------------|-----------------|
| Operating temperature range | -55°C to +125°C |
| Storage temperature range   | -55°C to +125°C |

| Customer Part number | Murata Part number | Impedance (Ω) |          | Rated current (mA) | DC resistance (Ω) max. |                      | Remark                     |
|----------------------|--------------------|---------------|----------|--------------------|------------------------|----------------------|----------------------------|
|                      |                    | at 100 MHz    | at 1 GHz |                    | Initial values         | Values after testing |                            |
|                      | BLM15HG601SN1D     | 600±25%       | 1000±40% | 300                | 0.7                    | 0.8                  | For general use            |
|                      | BLM15HG102SN1D     | 1000±25%      | 1400±40% | 250                | 1.1                    | 1.2                  | For general use            |
|                      | BLM15HD601SN1D     | 600±25%       | 1400±40% | 300                | 0.85                   | 0.95                 | For high speed signal line |
|                      | BLM15HD102SN1D     | 1000±25%      | 2000±40% | 250                | 1.25                   | 1.35                 | For high speed signal line |
|                      | BLM15HD182SN1D     | 1800±25%      | 2700±40% | 200                | 2.2                    | 2.3                  | For high speed signal line |
|                      | BLM15HB121SN1D     | 120±25%       | 500±40%  | 300                | 0.7                    | 0.8                  | For high speed signal line |
|                      | BLM15HB221SN1D     | 220±25%       | 900±40%  | 250                | 1.0                    | 1.1                  | For high speed signal line |

### 4. Testing Conditions

|                            |   |
|----------------------------|---|
| Unless otherwise specified | Temperature: ordinary temperature (15°C to 35°C)<br>Humidity: ordinary humidity [25% to 85% (RH)] |
| In case of doubt           | Temperature: 20°C±2°C<br>Humidity: 60% to 70% (RH)<br>Atmospheric pressure: 86 kPa to 106 kPa     |

### 5. Appearance and Dimensions

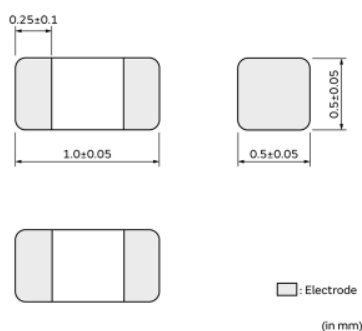

Equivalent circuit

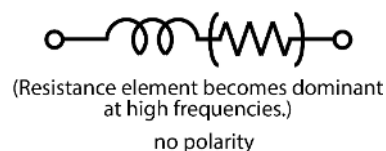

Unit mass (typical value): 0.001 g

## 6. Marking

No marking.

## 7. Electrical Performance

| No. | Item          | Specification           | Test method  |
|-----|---------------|-------------------------|--|
| 7.1 | Impedance     | Meet chapter 3 ratings. | Measuring equipment: Keysight 4291A or the equivalent<br>Measuring frequency: 100 MHz $\pm$ 1 MHz, 1 GHz $\pm$ 1 MHz<br>Measuring fixture: Keysight 16192A or the equivalent |
| 7.2 | DC resistance | Meet chapter 3 ratings. | Measuring equipment: digital multimeter<br>Substrate wiring resistance is excluded.  |

## 8. Mechanical Performance

The product is soldered on a substrate for test. (Excluding appearance and dimensions, drop, resistance to soldering heat, and solderability)

(Test shall be done using flux, solder and soldering condition which are specified in chapter 12 except the case of being specified special condition.)

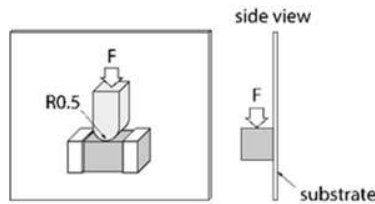
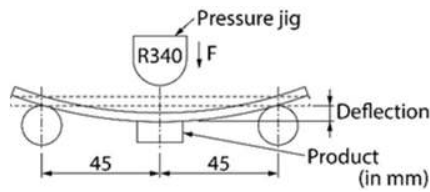
| No. | Item                         | Specification   | Test method  |
|-----|------------------------------|---|--|
| 8.1 | Appearance and Dimensions    | Meet chapter 5.   | Visual inspection and measured with slide calipers.  |
| 8.2 | Shear test                   | Appearance: No significant mechanical damage shall be observed.<br>Impedance change rate (at 100 MHz): within $\pm$ 30%<br>DC resistance: Meet chapter 3 ratings. | Applying force: 5 N<br>Holding time: 5 s $\pm$ 1 s<br>Force application direction:<br>  |
| 8.3 | Bending test                 | Appearance: No significant mechanical damage shall be observed.<br>Impedance change rate (at 100 MHz): within $\pm$ 30%<br>DC resistance: Meet chapter 3 ratings. | Test substrate: glass-epoxy substrate (100 mm $\times$ 40 mm $\times$ 0.8 mm)<br>Pressurizing speed: 0.5 mm/s<br>Pressure jig: R340<br>Deflection: 2.0 mm<br>Holding time: 30 s<br>  |
| 8.4 | Vibration                    | Appearance: No significant mechanical damage shall be observed.<br>Impedance change rate (at 100 MHz): within $\pm$ 30%<br>DC resistance: Meet chapter 3 ratings. | Oscillation frequency: 10 Hz to 2000 Hz to 10 Hz, for approx. 20 min<br>Total amplitude: 1.5 mm or acceleration amplitude of 196 m/s <sup>2</sup> , whichever is smaller<br>Test time: 3 directions perpendicular to each other, 2 h for each direction (6 h in total)   |
| 8.5 | Resistance to soldering heat | Appearance: No significant mechanical damage shall be observed.<br>Impedance change rate (at 100 MHz): within $\pm$ 30%<br>DC resistance: Meet chapter 3 ratings. | Flux: ethanol solution with a rosin content of 25(wt)%<br>Pre-heating: 150°C $\pm$ 10°C/60 s to 90 s<br>Solder: Sn-3.0Ag-0.5Cu solder<br>Solder temperature: 270°C $\pm$ 5°C<br>Immersion time: 10 s $\pm$ 0.5 s<br>Immersion and emersion rates: 25 mm/s<br>Post-treatment: left at a room condition for 48 h $\pm$ 4 h |

| No. | Item          | Specification   | Test method  |
|-----|---------------|---|--|
| 8.6 | Drop          | Appearance shall have no significant mechanical damage.                         | The product shall be dropped on concrete or steel board.<br>Method: free fall<br>Height: 75 cm<br>Attitude from which the product is dropped: 3 directions<br>Number of times: 3 times for each direction (Total 9 times)            |
| 8.7 | Solderability | 95% or more of the outer electrode shall be covered with new solder seamlessly. | Flux: ethanol solution with a rosin content of 25(wt)%<br>Pre-heating: 150°C±10°C/60 s to 90 s<br>Solder: Sn-3.0Ag-0.5Cu solder<br>Solder temperature: 240°C±5°C<br>Immersion time: 3 s±1 s<br>Immersion and emersion rates: 25 mm/s |

## 9. Environmental Performance

The product is soldered on a glass-epoxy substrate for test.

(Test shall be done using flux, solder and soldering condition which are specified in chapter 12 except the case of being specified special condition.)

| No. | Item              | Specification  | Test method   |
|-----|-------------------|--|---|
| 9.1 | Temperature cycle | Appearance: No significant mechanical damage shall be observed.<br>Impedance change rate (at 100 MHz): within ±30%<br>DC resistance: Meet chapter 3 ratings. | Single cycle conditions:<br>Step 1: -55°C (+0°C, -3°C)/30 min±3 min<br>Step 2: ordinary temperature/3 min<br>Step 3: +125°C (+3°C, -0°C)/30 min±3 min<br>Step 4: ordinary temperature/3 min<br>Number of testing: 100 cycles<br>Post-treatment: left at a room condition for 48 h±4 h |
| 9.2 | Humidity          | Appearance: No significant mechanical damage shall be observed.<br>Impedance change rate (at 100 MHz): within ±30%<br>DC resistance: Meet chapter 3 ratings. | Temperature: 70°C±2°C<br>Humidity: 90% (RH) to 95% (RH)<br>Test time: 1000 h (+48 h, -0 h)<br>Post-treatment: left at a room condition for 48 h±4 h   |
| 9.3 | Heat life         | Appearance: No significant mechanical damage shall be observed.<br>Impedance change rate (at 100 MHz): within ±30%<br>DC resistance: Meet chapter 3 ratings. | Temperature: 125°C±3°C<br>Applied current: rated current at test temperature<br>Test time: 1000 h (+48 h, -0 h)<br>Post-treatment: left at a room condition for 48 h±4 h  |
| 9.4 | Cold resistance   | Appearance: No significant mechanical damage shall be observed.<br>Impedance change rate (at 100 MHz): within ±30%<br>DC resistance: Meet chapter 3 ratings. | Temperature: -55°C±2°C<br>Test time: 1000 h (+48 h, -0 h)<br>Post-treatment: left at a room condition for 48 h±4 h  |

## 10. Specification of Packaging

### 10.1 Appearance and dimensions of tape (8 mm width/paper tape)

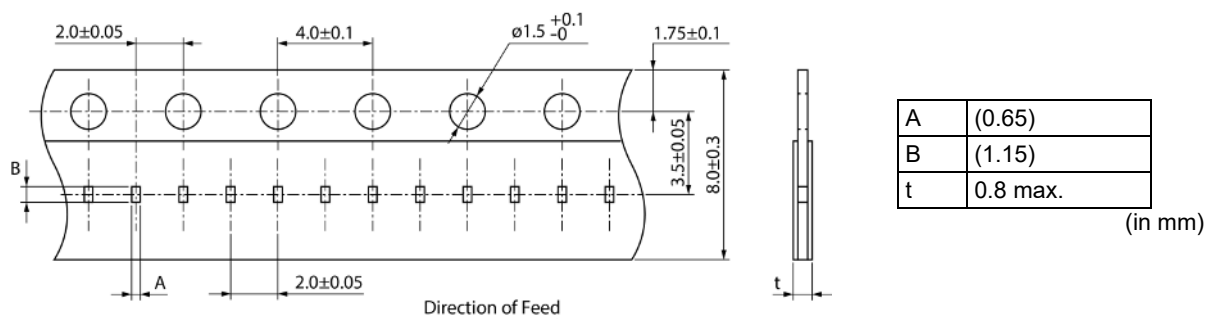

**10.2 Taping specifications**

|                                      |   |
|--------------------------------------|---|
| Packing quantity (Standard quantity) | 10000 pcs/reel  |
| Packing method                       | The products are placed in cavities of a carrier tape and sealed by a cover tape (top tape and bottom tape when the cavities of the carrier tape are punched type).       |
| Feed hole position                   | The feed holes on the carrier tape are on the right side when the cover tape (top tape when the cavities of the carrier tape are punched type) is pulled toward the user. |
| Joint                                | The carrier tape and cover tape (top tape when the cavities of the carrier tape are punched type) are seamless.   |
| Number of missing products           | Number of missing products within 0.025% of the number per reel or 1 pc., whichever is greater, and are not continuous. The specified quantity per reel is kept.          |

**10.3 Break down force of tape**

|   |          |
|---|----------|
| Cover tape (or top tape)  | 5 N min. |
| Bottom tape (only when the cavities of the carrier tape are punched type) | 5 N min. |

**10.4 Peeling off force of tape**

|                      |  |
|----------------------|--|
| Speed of peeling off | 300 mm/min   |
| Peeling off force    | 0.1 N to 0.6 N (The lower limit is for typical value.) |

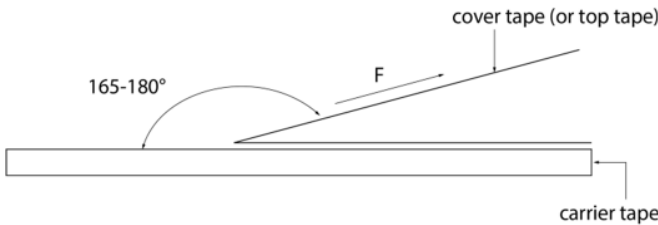

**10.5 Dimensions of leader section, trailer section and reel**

A vacant section is provided in the leader (start) section and trailer (end) section of the tape for the product. The leader section is further provided with an area consisting only of the cover tape (or top tape). (See the diagram below.)

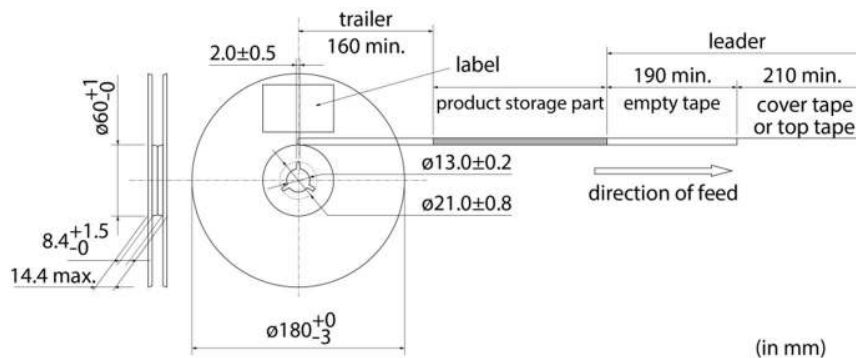

**10.6 Marking for reel**

Customer part number, Murata part number, inspection number (\*1), RoHS marking (\*2), quantity, etc.

|   |   |
|---|---|
| *1 Expression of inspection No.:<br>□□    ○○○○    ◇◇◇◇<br>(1)    (2)    (3) | (1) Factory code<br>(2) Date<br>First digit: year/last digit of year<br>Second digit: month/Jan. to Sep. → 1 to 9, Oct. to Dec. → O, N, D<br>Third, Fourth digit: day<br>(3) Serial No. |
| *2 Expression of RoHS marking:<br>ROHS-    Y    (△)<br>(1)    (2)           | (1) RoHS regulation conformity<br>(2) Murata classification number  |

**10.7 Marking on outer box (corrugated box)**

Customer name, purchasing order number, customer part number, Murata part number, RoHS marking (\*2), quantity, etc.

**10.8 Specification of outer box**

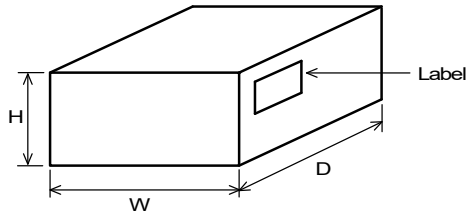

| Dimensions of outer box (mm)   |     |    | Standard reel quantity in outer box (reel) |
|--|-----|----|--|
| W  | D   | H  |  |
| 186  | 186 | 93 | 5  |
| * Above outer box size is typical. It depends on a quantity of an order. |     |    |  |

**11. ⚠Caution**

**11.1 Restricted applications**

Please contact us before using our products for the applications listed below which require especially high reliability for the prevention of defects which might directly cause damage to the third party's life, body or property.

- |                               |   |                              |   |
|-------------------------------|---|------------------------------|---|
| (1) Aircraft equipment        | (2) Aerospace equipment   | (3) Undersea equipment       | (4) Power plant control equipment       |
| (5) Medical equipment         | (6) Transportation equipment (vehicles, trains, ships, etc.)  | (7) Traffic signal equipment | (8) Disaster/crime prevention equipment |
| (9) Data-processing equipment | (10) Applications of similar complexity and/or reliability requirements to the applications listed in the above |                              |   |

**11.2 Precautions on rating**

Avoid using in exceeded the rated temperature range, rated voltage, or rated current. Usage when the ratings are exceeded could lead to wire breakage, burning, or other serious fault.

**11.3 Inrush current**

If an inrush current (or pulse current or rush current) that significantly exceeds the rated current is applied to the product, overheating could occur, resulting in wire breakage, burning, or other serious fault.

**11.4 Corrosive gas**

Please refrain from use since contact with environments with corrosive gases (sulfur gas [hydrogen sulfide, sulfur dioxide, etc.], chlorine, ammonia, etc.) or oils (cutting oil, silicone oil, etc.) that have come into contact with the previously stated corrosive gas environment will result in deterioration of product quality or an open from deterioration due to corrosion of product electrode, etc. We will not bear any responsibility for use under these environments.

**12. Precautions for Use**

This product is for use only with reflow soldering. It is designed to be mounted by soldering. If you want to use other mounting method, for example, using a conductive adhesive, please consult us beforehand. Also, if repeatedly subjected to temperature cycles or other thermal stress, due to the difference in the coefficient of thermal expansion with the mounting substrate, the solder (solder fillet part) in the mounting part may crack. The occurrence of cracks due to thermal stress is affected by the size of the land where mounted, the solder volume, and the heat dissipation of the mounting substrate. Carefully design it when a large change in ambient temperature is assumed.

**12.1 Land dimensions**

The following diagram shows the recommended land dimensions for reflow soldering:

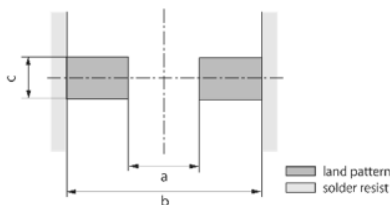

|   |     |
|---|-----|
| a | 0.4 |
| b | 1.2 |
| c | 0.5 |

(in mm)

## 12.2 Flux and solder used

|        |  |
|--------|--|
| Flux   | <ul style="list-style-type: none"> <li>• Use a rosin-based flux.</li> <li>• Do not use a highly acidic flux with a halide content exceeding 0.2(wt)% (chlorine conversion value).</li> <li>• Do not use a water-soluble flux.</li> </ul> |
| Solder | <ul style="list-style-type: none"> <li>• Use Sn-3.0Ag-0.5Cu solder.</li> <li>• Standard thickness of solder paste: 100 μm to 200 μm</li> </ul>   |

If you want to use a flux other than the above, please consult our technical department.

## 12.3 Soldering conditions (reflow)

- Pre-heating should be in such a way that the temperature difference between solder and product surface is limited to 150°C max.  
Cooling into solvent after soldering also should be in such a way that the temperature difference is limited to 100°C max. Insufficient pre-heating may cause cracks on the product, resulting in the deterioration of product quality.
- Standard soldering profile and the limit soldering profile is as follows.  
The excessive limit soldering conditions may cause leaching of the electrode and/or resulting in the deterioration of product quality.

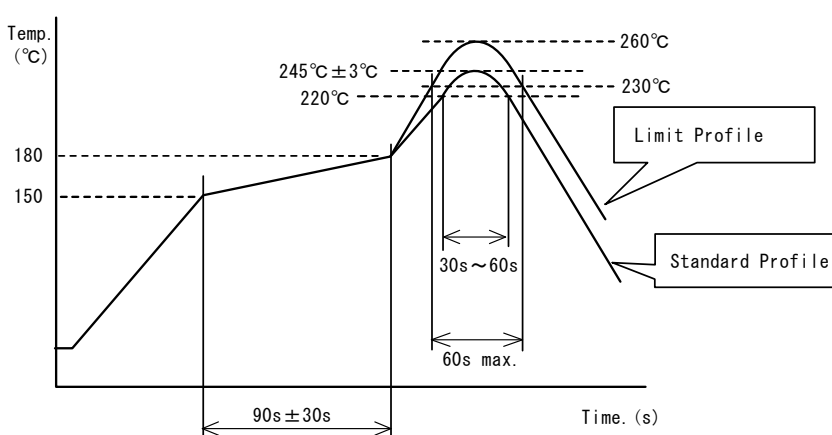

|                         | Standard profile           | Limit profile              |
|-------------------------|----------------------------|----------------------------|
| Pre-heating             | 150°C to 180°C/90 s ± 30 s | 150°C to 180°C/90 s ± 30 s |
| Heating                 | Above 220°C/30 s to 60 s   | Above 230°C/60 s max.      |
| Peak temperature        | 245°C ± 3°C                | 260°C/10 s                 |
| Number of reflow cycles | 2 times                    | 2 times                    |

## 12.4 Reworking with soldering iron

The following requirements must be met to rework a soldered product using a soldering iron.

| Item                                | Requirement         |
|-------------------------------------|---------------------|
| Pre-heating                         | 150°C/approx. 1 min |
| Tip temperature of soldering iron   | 350°C max.          |
| Power consumption of soldering iron | 80 W max.           |
| Tip diameter of soldering iron      | ø3 mm max.          |
| Soldering time                      | 3 s (+1 s, -0 s)    |
| Number of reworking operations      | 2 times max.        |

\* Avoid a direct contact of the tip of the soldering iron with the product. Such a direction contact may cause cracks in the ceramic body due to thermal shock.

## 12.5 Solder volume

Solder shall be used not to be exceeded the upper limits as shown below.

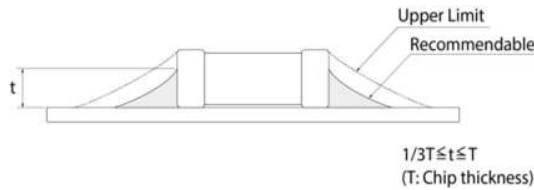

An increased solder volume increases mechanical stress on the product. Exceeding solder volume may cause the failure of mechanical or electrical performance.

## 12.6 Product's location

The following shall be considered when designing and laying out PCBs.

(1) PCB shall be designed so that products are not subject to mechanical stress due to warping the board.

[Products direction]

Products shall be located in the sideways direction (length:  $a < b$ ) to the mechanical stress.

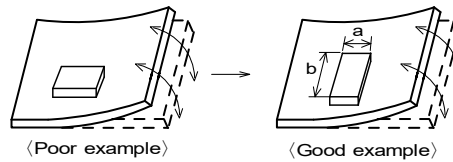

(2) Components location on PCB separation

It is effective to implement the following measures, to reduce stress in separating the board.

It is best to implement all of the following three measures; however, implement as many measures as possible to reduce stress.

| Contents of measures  | Stress level |
|---|--------------|
| (1) Turn the mounting direction of the component parallel to the board separation surface.  | $A > D^*1$   |
| (2) Add slits in the board separation part.   | $A > B$      |
| (3) Keep the mounting position of the component away from the board separation surface.   | $A > C$      |
| *1 $A > D$ is valid when stress is added vertically to the perforation as with hand separation.<br>If a cutting disc is used, stress will be diagonal to the PCB, therefore $A > D$ is invalid. |              |

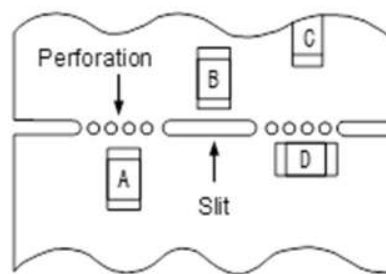

(3) Mounting components near screw holes

When a component is mounted near a screw hole, it may be affected by the board deflection that occurs during the tightening of the screw.

Mount the component in a position as far away from the screw holes as possible.

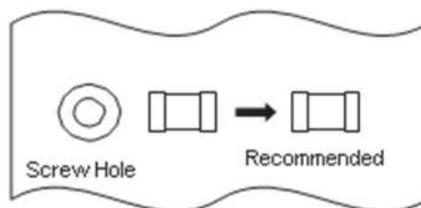

**12.7 Handling of substrate**

After mounting products on a substrate, do not apply any stress to the product caused by bending or twisting to the substrate when cropping the substrate, inserting and removing a connector from the substrate or tightening screw to the substrate. Excessive mechanical stress may cause cracking in the product.

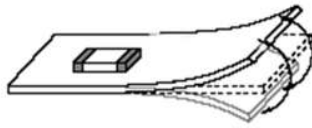

Bending

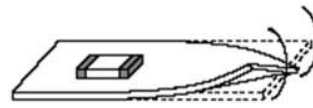

Twisting

**12.8 Cleaning**

When cleaning this product, observe the following conditions.

Any cleaning may cause deterioration in the quality of the product, so please check the quality of this product before use.

(1) The cleaning temperature shall be 60°C max. If isopropyl alcohol (IPA) is used, the cleaning temperature shall be 40°C max.

(2) When ultrasonic cleaning is used, under some cleaning conditions, the substrate could resonate and the substrate vibrations could result in chip cracks, solder breakage, and other problems. Be sure to always perform a test cleaning beforehand using an actual cleaning device, and then check the quality of the products.

(3) Cleaner

Alcohol-based cleaner: IPA

Aqueous agent: PINE ALPHA ST-100S

(4) There shall be no residual flux or residual cleaner.

When using aqueous agent, rinse the product with deionized water adequately and completely dry it so that no cleaner is left.

\* For other cleaning, please consult our technical department.

**12.9 Storage and transportation**

|                    |  |
|--------------------|--|
| Storage period     | Use the product within 12 months after delivery.<br>If you do not use the product for more than 12 months, check solderability before using it.  |
| Storage conditions | <ul style="list-style-type: none"> <li>The products shall be stored in a room not subject to rapid changes in temperature and humidity. The recommended temperature range is -10°C to +40°C. The recommended relative humidity range is 15% to 85%. Keeping the product in corrosive gases, such as sulfur, chlorine gas or acid may cause the poor solderability.</li> <li>Do not place the products directly on the floor; they should be placed on a palette so that they are not affected by humidity or dust.</li> <li>Avoid keeping the products in a place exposed to direct sunlight, heat or vibration.</li> <li>Do not keep products in bulk packaging. Bulk storage could result in collisions between the products or between the products and other parts, resulting in chipping or wire breakage.</li> <li>Avoid storing the product by itself bare (i.e. exposed directly to air).</li> </ul> |
| Transportation     | Excessive vibration and impact reduces the reliability of the products. Exercise caution when handling the products.   |

**12.10 Resin coating (including moisture-proof coating)**

When the product is coated/molded with resin, its electrical characteristics may change.

A wire breakage issue may occur by mechanical stress caused by the resin, amount/cured shape of resin, or operating condition etc.

Some resins contain impurities or hydrolyzable chlorine, which could result in corrosion of the conducting materials, leading to wire breakage.

So, please pay your careful attention when you select resin in case of coating/molding the products with the resin.

Prior to use the coating resin, please make sure no reliability issue is observed by evaluating products mounted on your board.

**12.11 Mounting conditions**

Check the mounting condition before using.

Using mounting conditions (nozzles, equipment conditions, etc.) that are not suitable for products may lead to pick up errors, misalignment, or damage to the product.

**12.12 Operating environment**

Do not use this product under the following environmental conditions as it may cause deterioration of product quality.

(1) In the corrodible atmosphere such as acidic gases, alkaline gases, chlorine, sulfur gases, organic gases and etc.

(the sea breeze, Cl<sub>2</sub>, H<sub>2</sub>S, NH<sub>3</sub>, SO<sub>2</sub>, NO<sub>2</sub>, etc)

(2) In the atmosphere where liquid such as organic solvent, may splash on the products.

(3) In the atmosphere where the temperature/humidity changes rapidly and it is easy to dew.



### **12.13 Mounting density**

If this product is placed near heat-generating products, be sure to implement sufficient heat-dissipating measures.

If this product is subjected to a significant amount of heat from other products, this could adversely affect product quality, resulting in a circuit malfunction or failure of the mounted section. Also, be sure that the product is used in a manner so that the heat that the product is subjected to from other products does not exceed the upper limit of the rated operating temperature for the product.

### **13. Note**

- (1) Please make sure that your product has been evaluated in view of your specifications with our product being mounted to your product.
- (2) You are requested not to use our product deviating from the reference specifications.
- (3) The contents of this reference specification are subject to change without advance notice. Please approve our product specifications or transact the approval sheet for product specifications before ordering.