

SFP-25GB-CW-27-40-C

MSA and TAA Compliant 25GBase-CWDM SFP28 Transceiver (SMF, 1270nm, 40km, LC, DOM)

Features

- Up to 25.78Gbps Data Links
- Up to 40km transmission on SMF
- CWDM DFB Laser and APD receiver
- Metal enclosure, for lower EMI
- Hot-pluggable SFP28 footprint
- Specifications compliant with SFF 8472
- Dual CDR with bypass function
- Compliant with SFF-8402 with LC connector
- 2-wire interface with integrated Digital Diagnostic monitoring
- Single 3.3V power supply
- Power dissipation < 2.0W
- Operating temperature: 0°C to 70°C
- RoHS compliant and Lead Free



Applications

- High speed storage area networks
- 25G Ethernet
- CPRI

Product Description

This MSA and TAA compliant SFP28 transceiver provides 25GBase-CWDM throughput up to 40km over single-mode fiber (SMF) using a wavelength of 1270nm via an LC connector. It is guaranteed to be 100% compatible with the equivalent MSA compliant transceiver. This easy to install, hot swappable transceiver has been programmed, uniquely serialized and data-traffic and application tested to ensure that it will initialize and perform identically. Digital optical monitoring (DOM) support is also present to allow access to real-time operating parameters. This transceiver is Trade Agreements Act (TAA) compliant. We stand behind the quality of our products and proudly offer a limited lifetime warranty.

ProLabs' transceivers are RoHS compliant and lead-free.

TAA refers to the Trade Agreements Act (19 U.S.C. & 2501-2581), which is intended to foster fair and open international trade. TAA requires that the U.S. Government may acquire only "U.S. – made or designated country end products."



Regulatory Compliance

- ESD to the Electrical PINs: compatible with MIL-STD-883E Method 3015.4
- ESD to the LC Receptacle: compatible with IEC 61000-4-3
- EMI/EMC compatible with FCC Part 15 Subpart B Rules, EN55022:2010
- Laser Eye Safety compatible with FDA 21CFR, EN60950-1& EN (IEC) 60825-1,2
- RoHS compliant with EU RoHS 2.0 directive 2015/863/EU

CWDM Available Wavelengths

Wavelengths	Min.	Typ.	Max.
27	1264.5	1271	1277.5
29	1284.5	1291	1297.5
31	1304.5	1311	1317.5

Absolute Maximum Ratings

Parameter	Symbol	Min.	Typ.	Max.	Unit	Notes
Maximum Supply Voltage	Vcc	-0.3		4	V	
Storage Temperature	TS	-40		85	°C	
Operating Case Temperature	Tc	0		70	°C	
Relative Humidity (non-condensing)						
Data Rate	BR		25.78		Gbps	1
Transmission Distance	TD		40		km	
Coupled fiber		Single mode fiber				2

Notes:

1. TX Rate/RX Rate
2. 9/125um SMF

Electrical Characteristics

Parameter	Symbol	Min.	Typ.	Max.	Unit	Notes
Power Supply Voltage	Vcc	3.14	3.3	3.47	V	
Power Supply Current	Icc			550	mA	
	Icc			600	mA	
Signal Input Voltage	VSI	Vcc-0.3		Vcc+0.3	V	
Transmitter						
Input differential impedance	Rin		100		Ω	1
Single ended data input swing	Vin,pp	180		700	mV	
Transmitter Fault Output-High	VFaultH	2		Vcc+0.3	V	
Transmitter Fault Output-Low	VFaultL	0		0.8	V	
Transmitter Disable Voltage- High	VDisH	2		Vcc+0.3	V	
Transmitter Disable Voltage- low	VDisL	0		0.8	V	
Receiver						
Differential data output swing	Vout,pp	300		850	mV	2
LOS Output Voltage-High	VLOSH	2		Vcc+0.3	V	
LOS Output Voltage-Low	VLOSL	0		0.8	V	

Notes:

1. Connected directly to TX data input pins. AC coupled thereafter.
2. Into 100 ohms differential termination.

Optical Characteristics

Parameter	Symbol	Min.	Typ.	Max.	Unit	Notes
Transmitter						
Average Launched Power	P_o	0		+6.0	dBm	
Center Wavelength Range	λ_C	$\lambda-6.5$		$\lambda+6.5$	nm	1
Spectrum Bandwidth (-20dB)	$\Delta\lambda$			1	nm	
Side-Mode Suppression Ratio	SMSR	30			dB	
Extinction Ratio	ER	3.5			dB	2
Relative Intensity Noise	$RIN_{20\text{OMA}}$			-130	dB/Hz	
Average Launched Power (Laser Off)	P_{off}			-30		
Optical return loss tolerance				20	dB	
Transmitter reflectance				-12	dB	
Transmitter eye mask definition {X1, X2, X3, Y1, Y2, Y3} Hit ratio 5×10^{-5} hits per sample		{0.31, 0.4, 0.45, 0.34, 0.38, 0.4}				3
Receiver						
Input Optical Wavelength	λ_{IN}	1270		1610	nm	
Damage threshold		-3			dBm	
Receiver Sensitivity	P_{sen1}			-19	dBm	4
Input Saturation Power (Overload)	P_{SAT}	-6			dBm	4
Los Of Signal Assert	P_A	-35			dBm	
Los Of Signal De-assert	P_D			-20	dBm	
LOS -Hysteresis	P_{Hys}	0.5		6	dB	

Notes:

1. λ is: 1271~1311 (nm)
2. Measured with a PRBS 231-1 test pattern, @25.78Gb/s.
3. Transmitter eye mask definition, Compliant with IEEE 802.3cc.
4. Measured with Light source 1310nm, ER=3.5dB; BER = $<5 \times 10^{-5}$ @PRBS=231-1 NRZ.

Pin Descriptions

Pin	Symbol	Name/Descriptions	Ref.
1	VeeT	Transmitter Ground (Common with Receiver Ground).	1
2	TX Fault	Transmitter Fault. LVTTTL-O	2
3	TX Disable	Transmitter Disable. Laser output disabled on high or open. LVTTTL-I.	3
4	SDA	2-Wire Serial Interface Data Line (Same as MOD-DEF2 in INF-8074i). LVTTTL-I/O.	
5	SCL	2-Wire Serial Interface Data Line (Same as MOD-DEF2 in INF-8074i). LVTTTL-I.	
6	MOD_ABS	Module Absent, Connect to VeeT or VeeR in Module.	4
7	RS0	Rate Select 0. Not used	5
8	LOS	Loss of Signal indication. Logic 0 indicates normal operation. LVTTTL-O.	2
9	RS1	Rate Select 1. Not used	5
10	VeeR	Receiver Ground (Common with Transmitter Ground).	1
11	VeeR	Receiver Ground (Common with Transmitter Ground).	1
12	RD-	Receiver Inverted DATA out. AC Coupled. CML-O.	
13	RD+	Receiver Non-inverted DATA out. AC Coupled. CML-O.	
14	VeeR	Receiver Ground (Common with Transmitter Ground).	1
15	VccR	Receiver Power Supply.	
16	VccT	Transmitter Power Supply.	
17	VeeT	Transmitter Ground (Common with Receiver Ground).	1
18	TD+	Transmitter Non-Inverted DATA in. AC Coupled. CML-I.	
19	TD-	Transmitter Inverted DATA in. AC Coupled. CML-O.	
20	VeeT	Transmitter Ground (Common with Receiver Ground).	1

Notes:

1. The module signal ground contacts, VeeR and VeeT, should be isolated from the module case.
2. This contact is an open collector/drain output and should be pulled up to the Vcc_Host with resistor in the range 4.7K Ω to 10K Ω . Pull ups can be connected to one or several power supplies, however the host board design shall ensure that no module contract has voltage exceeding module VccT/R +0.5.V.
3. Tx_Disable is an input contact with a 4.7K Ω to 10K Ω pull-up resistor to VccT inside module.
4. Mod_ABS is connected to VeeT or VeeR in the SFP+ module. The host may pull the contract up to Vcc_Host with a resistor in the range from 4.7K Ω to 10K Ω . Mod_ABS is asserted "High" when the SFP+ module is physically absent from a host slot.
5. Internally pulled down per SFF-8431

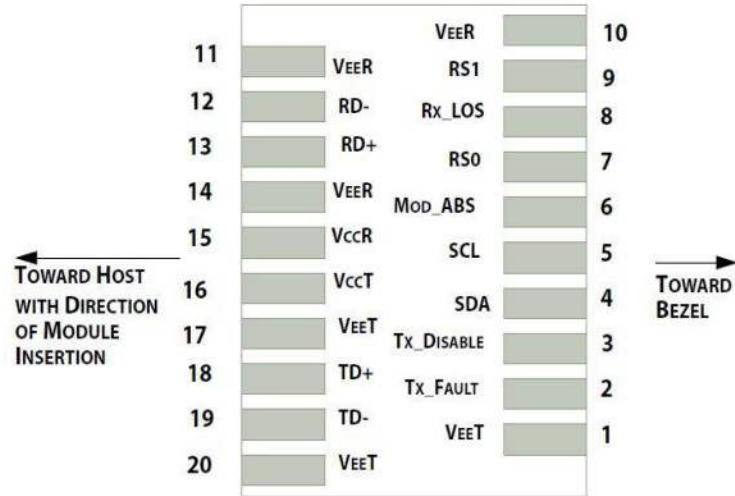

Pin-out of connector Block on Host board

Recommended Interface Circuit Schematic

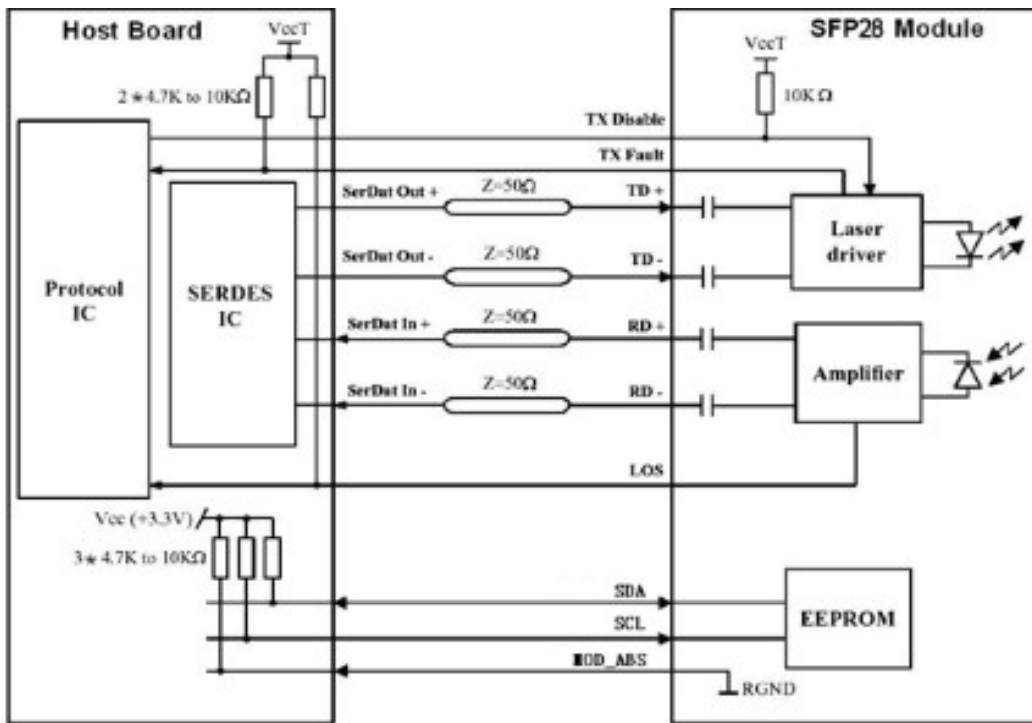

Mechanical Specifications

Small Form Factor Pluggable (SFP) transceivers are compatible with the dimensions defined by the SFP Multi-Sourcing Agreement (MSA).

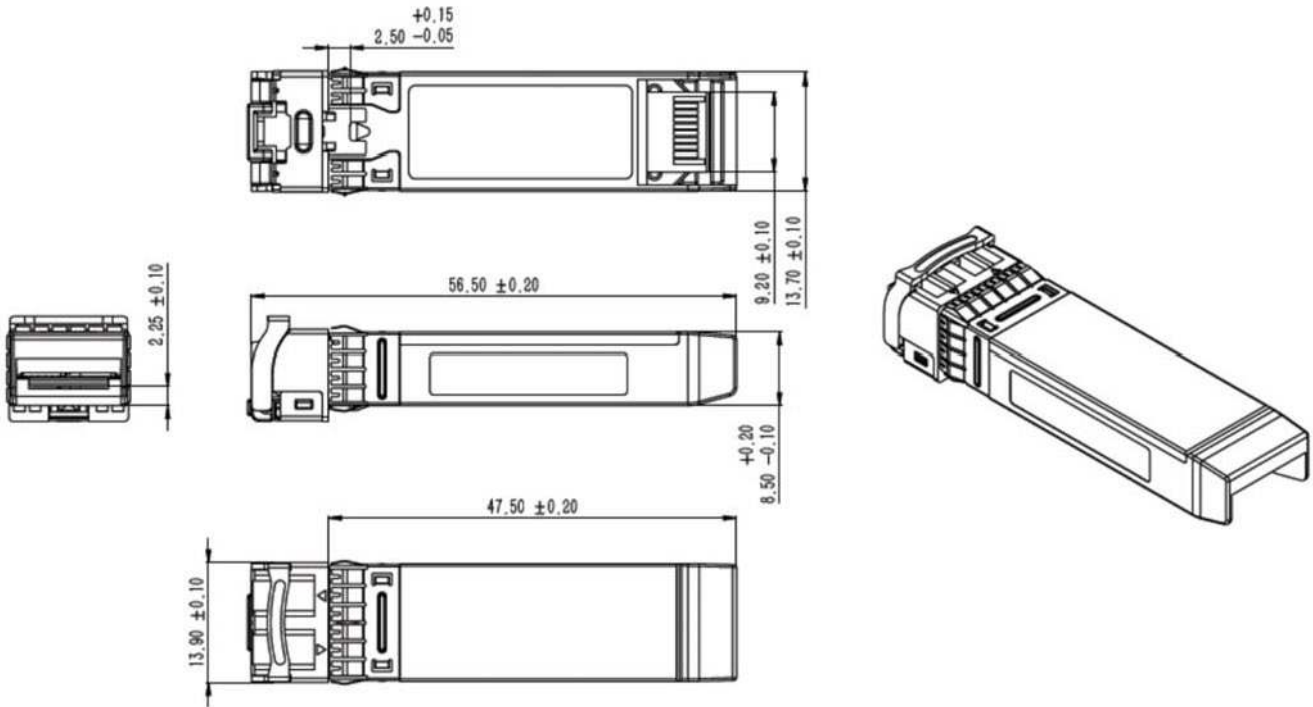

EEPROM Information

EEPROM memory map specific data field description is as below:

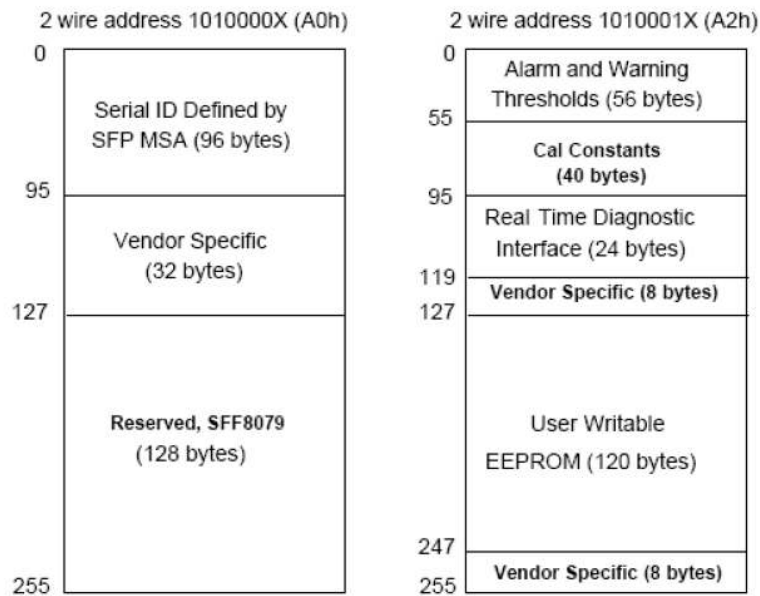

About ProLabs

Our experience comes as standard; for over 15 years ProLabs has delivered optical connectivity solutions that give our customers freedom and choice through our ability to provide seamless interoperability. At the heart of our company is the ability to provide state-of-the-art optical transport and connectivity solutions that are compatible with over 90 optical switching and transport platforms.

Complete Portfolio of Network Solutions

ProLabs is focused on innovations in optical transport and connectivity. The combination of our knowledge of optics and networking equipment enables ProLabs to be your single source for optical transport and connectivity solutions from 100Mb to 400G while providing innovative solutions that increase network efficiency. We provide the optical connectivity expertise that is compatible with and enhances your switching and transport equipment.

Trusted Partner

Customer service is our number one value. ProLabs has invested in people, labs and manufacturing capacity to ensure that you get immediate answers to your questions and compatible product when needed. With Engineering and Manufacturing offices in the U.K. and U.S. augmented by field offices throughout the U.S., U.K. and Asia, ProLabs is able to be our customers best advocate 24 hours a day.

Contact Information

ProLabs US

Email: sales@prolabs.com

Telephone: 952-852-0252

ProLabs UK

Email: salesupport@prolabs.com

Telephone: +44 1285 719 600