

<p>GlobTek, Inc. www.globtek.com 186 Veterans Drive, Northvale, NJ 07647 Tel. (201) 784-1000 Fax (201) 784-0111</p>	<p>Drawing Title: GTM96600-6512-P2, ICT / ITE / Medical Power Supply/Class 2/Household Power Supply, Efficiency Level: USA DOE Level VI / Eco-design Directive 2009/125/EC, (EU) 2019/1782, Case Color/Style: GlobTek Black, Potted/Encapsulated in plastic housing, Regulated Switchmode AC-DC Power Supply AC Adaptor, Input Rating: 100-240V~, 50-60 Hz, Lead Wires , Output Rating: 65W, 12.0V@5.41A, Output Configuration: 1500 mm, 18/2 Cond, H05RN-F (OR EQUIVALENT OUTDOOR CABLE), T-plug system (includes 5.5x2.5, 5.5x2.1, 3.5x1.3mm plugs in each kit), Ferrite: Core Size: 26 x 28.5 x 16, GlobTek Black, GT Cord # C52501, Pin Out: Polarity Configuration T00 All plugs are Medical Grade, Locking, Polarized once installed, and single use only. Product demonstration link: https://en.globtek.com/news/t00-changeable-output-plug-system-for-power-supplies MOLDED CONNECTORS AVAILABLE, Blades/Input Cord: IEC60320-C8 Universal Fixed Input Cord: 2 Conductor, H05RN-F 0.75mm 2C, 1830 mm, Black, terminated in an inline IEC60320/C8 IEC inlet, Approvals: CB 60950; CB 62368; CE; China RoHS; Double Insulation; EAC; cETLus 60601-1; IP68; PSE; PSE; PSE; Level VI; LPS 60950; RCM; Ukraine; VCCI; WEEE; cETLus UL1310 (36V only); UKCA; S-Mark IEC/EN 60601-1; CB 61158; Morocco; GEMS (5V) pending; RCM 5V (pending);FCC; Korea (5V On</p>	
	<p>Model No. GTM96600-6512-P2</p>	
	<p>Part No./Ordering No. PR9KE5416T00-IMR6B</p>	<p>Rev C</p>

In Addition to GlobTek Inc.'s renewed ISO9001:2015 - Quality Management System Certification, GlobTek Inc. is now certified to:

ISO13485:2016 - Medical Devices Quality Management System Certification

ISO14001:2015 - Environmental Management System Certification

ISO Certificates are available online at <https://www.globtek.com/iso-certificates/>

The acceptance of this specification and use of the product described in this document indicates the acceptance and binding of the customer to Globtek TERMS AND CONDITIONS (attached to the end of this document), which supersede all other agreements, terms, and conditions (<https://en.globtek.com/terms-and-conditions/>).

The purchaser of this product (Customer) agrees that it is their sole responsibility to determine suitability/fitness of the product described in this specification for their application and to take precautions for protection against any hazards attendant to the handling and use of the product.

Footnote:

GlobTek Inc. will not be liable for the safety and performance of these power supplies/battery packs if unauthorized access and repair occurs. End user should consult applicable UL, CSA or EN standards for proper installation instruction.

Limitation of Use:

GlobTek products are intended for use with commercial, medical, and/or industrial equipment only. GlobTek product are not authorized for use as mission critical components in life support hazardous environment, nuclear or aircraft applications without prior written approval from the CEO of GlobTek Inc.

Contents of this document are subject to change without prior notice.

Customer Approval of Specification:

Please approve, sign and send back to GlobTek so we can complete order processing.

A delay in receipt of this form will delay delivery schedule.

Company Name: _____	Customer P/N: _____
Quote Number: _____	Date: _____
Authorized Representative Name: _____	Authorized Representative Signature: _____

GlobTek, Inc. www.globtek.com 186 Veterans Drive, Northvale, NJ 07647 Tel. (201) 784-1000 Fax (201) 784-0111	Drawing Title: GTM96600-6512-P2, ICT / ITE / Medical Power Supply/Class 2/Household Power Supply, Efficiency Level: USA DOE Level VI / Eco-design Directive 2009/125/EC, (EU) 2019/1782, Case Color/Style: GlobTek Black, Potted/Encapsulated in plastic housing, Regulated Switchmode AC-DC Power Supply AC Adaptor, Input Rating: 100-240V~, 50-60 Hz, Lead Wires , Output Rating: 65W, 12.0V@5.41A, Output Configuration: 1500 mm, 18/2 Cond, H05RN-F (OR EQUIVALENT OUTDOOR CABLE), T-plug system (includes 5.5x2.5, 5.5x2.1, 3.5x1.3mm plugs in each kit), Ferrite: Core Size: 26 x 28.5 x 16, GlobTek Black, GT Cord # C52501, Pin Out: Polarity Configuration T00 All plugs are Medical Grade, Locking, Polarized once installed, and single use only. Product demonstration link: https://en.globtek.com/news/t00-changeable-output-plug-system-for-power-supplies MOLDED CONNECTORS AVAILABLE, Blades/Input Cord: IEC60320-C8 Universal Fixed Input Cord: 2 Conductor, H05RN-F 0.75mm 2C, 1830 mm, Black, terminated in an inline IEC60320/C8 IEC inlet, Approvals: CB 60950; CB 62368; CE; China RoHS; Double Insulation; EAC; cETLus 60601-1; IP68; PSE; PSE; PSE; Level VI; LPS 60950; RCM; Ukraine; VCCI; WEEE; cETLus UL1310 (36V only); UKCA; S-Mark IEC/EN 60601-1; CB 61158; Morocco; GEMS (5V) pending; RCM 5V (pending);FCC; Korea (5V On	
	Model No. GTM96600-6512-P2	
	Part No./Ordering No. PR9KE5416T00-IMR6B	Rev C

REVISION HISTORY

REV	DESCRIPTION	SUB	DATE	APPROVED
C	Input cord updated to 0.75mm 2 conductors Update: core size change to 26*28.5*16 mm, update outer carton size change to 545*485*250 mm, Qty change to 27pcs/carton, master carton GW change to: 20.3 kg , update label specs to ISO 15223 medical device compliant label	QA	08/27/2020	QA
B	Correct P/N from "5146" to "5416"; correct packing from standard DT to T00 cellular.	bsiep	07/17/2019	QA
A	Initial Release	bsiep	07/16/2019	QA

POWER SUPPLY INFORMATION

TYPE	Potted/Encapsulated in plastic housing
TECHNOLOGY	Regulated Switchmode AC-DC Power Supply AC Adaptor
CASE COLOR	GlobTek Black
NAMEPLATE RATED INPUT	100-240V~, 50-60 Hz, 1.5A
INPUT CONFIG	Lead Wires
WATTS	65.00
VOLTS OUT	12.0
CURRENT OUT (Amps)	5.41
BLADE/CORD INCLUDED	FC-IEC2-1830-Rubber IEC60320-C8 Universal Fixed Input Cord: 2 Conductor, H05RN-F 0.75mm 2C, 1830 mm, Black, terminated in an inline IEC60320/C8 IEC inlet
BLADE/CORD INSTALLED	N/A :Not Applicable
INGRESS PROTECTION	IP68
GROUNDING CONFIGURATION	(F1) Class II / Double Insulated
EFFICIENCY LEVEL	USA DOE Level VI / Eco-design Directive 2009/125/EC, (EU) 2019/1782
OUTPUT CONFIGURATION	1500 mm, 18/2 Cond, H05RN-F (OR EQUIVALENT OUTDOOR CABLE), T-plug system (includes 5.5x2.5, 5.5x2.1, 3.5x1.3mm plugs in each kit), Ferrite: Core Size: 26 x 28.5 x 16, GlobTek Black, GT Cord # C52501
OVERMOLDED	Yes
OUTPUT CONNECTOR GENDER	Female
CONNECTOR PIN OUT	Polarity Configuration T00 All plugs are Medical Grade, Locking, Polarized once installed, and single use only. Product demonstration link: https://en.globtek.com/news/t00-changeable-output-plug-system-for-power-supplies MOLDED CONNECTORS AVAILABLE
LABEL SPECS	ISO 15223 medical device compliant label,L-1470
SPECIAL BARCODE LABEL MATERIAL	No
PACK SPEC	Cell packing for DT plug model with T00 plug and manual
USER MANUAL	809-DESKTOPUSERMANUAL on A4 paper

PROPRIETARY INFORMATION

PROPRIETARY OF GLOBTEK, INC. ANY REPRODUCTION, DISCLOSURE OR USE OF THIS DRAWING, IN WHOLE OR IN PART, IS HEREBY PROHIBITED EXCEPT AS SPECIFIED IN WRITING BY GLOBTEK, INC. © GlobTek, Inc. 2019 - 2023

<p>GlobTek, Inc. www.globtek.com 186 Veterans Drive, Northvale, NJ 07647 Tel. (201) 784-1000 Fax (201) 784-0111</p>	<p>Drawing Title: GTM96600-6512-P2, ICT / ITE / Medical Power Supply/Class 2/Household Power Supply, Efficiency Level: USA DOE Level VI / Eco-design Directive 2009/125/EC, (EU) 2019/1782, Case Color/Style: GlobTek Black, Potted/Encapsulated in plastic housing, Regulated Switchmode AC-DC Power Supply AC Adaptor, Input Rating: 100-240V~, 50-60 Hz, Lead Wires , Output Rating: 65W, 12.0V@5.41A, Output Configuration: 1500 mm, 18/2 Cond, H05RN-F (OR EQUIVALENT OUTDOOR CABLE), T-plug system (includes 5.5x2.5, 5.5x2.1, 3.5x1.3mm plugs in each kit), Ferrite: Core Size: 26 x 28.5 x 16, GlobTek Black, GT Cord # C52501, Pin Out: Polarity Configuration T00 All plugs are Medical Grade, Locking, Polarized once installed, and single use only. Product demonstration link: https://en.globtek.com/news/t00-changeable-output-plug-system-for-power-supplies MOLDED CONNECTORS AVAILABLE, Blades/Input Cord: IEC60320-C8 Universal Fixed Input Cord: 2 Conductor, H05RN-F 0.75mm 2C, 1830 mm, Black, terminated in an inline IEC60320/C8 IEC inlet, Approvals: CB 60950; CB 62368; CE; China RoHS; Double Insulation; EAC; cETLus 60601-1; IP68; PSE; PSE; PSE; Level VI; LPS 60950; RCM; Ukraine; VCCI; WEEE; cETLus UL1310 (36V only); UKCA; S-Mark IEC/EN 60601-1; CB 61158; Morocco; GEMS (5V) pending; RCM 5V (pending);FCC; Korea (5V On</p>	
	<p>Model No. GTM96600-6512-P2</p>	
	<p>Part No./Ordering No. PR9KE5416T00-IMR6B</p>	<p>Rev C</p>

Notes/Modifications/Customizations (notes in this section supersede the values shown in the standard spec)
DIMENSIONS ARE IN MM UNLESS SPECIFIED OTHERWISE

<p>GlobTek, Inc. www.globtek.com 186 Veterans Drive, Northvale, NJ 07647 Tel. (201) 784-1000 Fax (201) 784-0111</p>	<p>Drawing Title: GTM96600-6512-P2, ICT / ITE / Medical Power Supply/Class 2/Household Power Supply, Efficiency Level: USA DOE Level VI / Eco-design Directive 2009/125/EC, (EU) 2019/1782, Case Color/Style: GlobTek Black, Potted/Encapsulated in plastic housing, Regulated Switchmode AC-DC Power Supply AC Adaptor, Input Rating: 100-240V~, 50-60 Hz, Lead Wires , Output Rating: 65W, 12.0V@5.41A, Output Configuration: 1500 mm, 18/2 Cond, H05RN-F (OR EQUIVALENT OUTDOOR CABLE), T-plug system (includes 5.5x2.5, 5.5x2.1, 3.5x1.3mm plugs in each kit), Ferrite: Core Size: 26 x 28.5 x 16, GlobTek Black, GT Cord # C52501, Pin Out: Polarity Configuration T00 All plugs are Medical Grade, Locking, Polarized once installed, and single use only. Product demonstration link: https://en.globtek.com/news/t00-changeable-output-plug-system-for-power-supplies MOLDED CONNECTORS AVAILABLE, Blades/Input Cord: IEC60320-C8 Universal Fixed Input Cord: 2 Conductor, H05RN-F 0.75mm 2C, 1830 mm, Black, terminated in an inline IEC60320/C8 IEC inlet, Approvals: CB 60950; CB 62368; CE; China RoHS; Double Insulation; EAC; cETLus 60601-1; IP68; PSE; PSE; PSE; Level VI; LPS 60950; RCM; Ukraine; VCCI; WEEE; cETLus UL1310 (36V only); UKCA; S-Mark IEC/EN 60601-1; CB 61158; Morocco; GEMS (5V) pending; RCM 5V (pending);FCC; Korea (5V On</p>	
	<p>Model No. GTM96600-6512-P2</p>	
	<p>Part No./Ordering No. PR9KE5416T00-IMR6B</p>	<p>Rev C</p>

ELECTRICAL SPECIFICATIONS

A) ELECTRICAL SPECIFICATIONS:

01. Input Voltage: Specified 90-264 Vac, Nameplate rated: 100-240Vac
 - 90-264 Vac range @ 100% of rated load current
 - 85-264 Vac range @ 85% of rated load current
 - 110-370 VDC range @ 100% of rated load current
02. Input Frequency: Specified 47-63 Hz, Nameplate rated 50-60Hz
03. Output Regulation: +/- 5% measured at the output connector
04. Line Voltage Regulation: +/- 0.5% typical measured at full load
05. Green Power On Indicator LED
06. Output Ripple (Vp-p): 1% or 100 mV whichever is greater, measured at 20 MHz bandwidth with 0.1 uf ceramic capacitor in parallel with a low impedance 47 uf electrolytic capacitor connected at the end of the output connector
07. Turn-ON/OFF Overshoot: 5% maximum, 1 mS typical recovery time for 40% to 70% step load
08. Turn-ON Delay: 1 second maximum @ full load, nominal line
09. Hold-Up Time: 8 mS typical @ nominal input voltage and full load
10. Inrush Current: 30A/60A maximum cold start @ 115/230Vac input
11. Efficiency: Compliant with Efficiency Level VI and CoC Tier 2 standards
12. No Load Standby Power: <0.075 W @ 230Vac for <= 49W output power rating, <0.15W @ 230Vac for > 49W output power rating

B) PROTECTION

01. Input Protection: Input line fusing and 300Vac MOV
02. Short Circuit/ Overload: Electronically Protected unit will auto recover upon removal of fault
 - Output Current Limit: 110% to 160% of rated output current
 - (upper end of current limit range is determined by normal output power rating, not derated output power level)
03. Output Over-Voltage: 110% to 130% of nominal output voltage

C) SAFETY

01. Dielectric Withstand Voltage: 4000Vac or 5656Vdc from input to output, On Class I models, 3000Vac or 4242Vdc from input to earth
02. Earth Leakage Current: Class I models < 300uA, N/A for Class II models
03. Touch Current: Class I models < 20uA, Class II models < 85uA, F2 Models < 20uA
04. [Output Isolation Options:](#)
 - a) C8 or C18 Inlet, Class II
 - b) C6 or C14 Inlet, Class II FE, Output Isolated from Earth contact
 - c) C6 or C14 Inlet, Class I, Output negative directly attached to Earth contact
05. Earth Continuity Test: < 0.1 Ohm between Earth Pin at AC input and PCB termination point (Class I models only)
06. Means of Protection: 2 x MOPP
07. Compliant Standards: See listings at end of this drawing for specifics

D) EMC

- EN 60601-1-2, 4th edition
- Emissions, per EN 55032, EN 61000-6-3, EN 61000-6-4
- Conducted Emissions: Class B, FCC Part 15, Class B
 - Radiated Emissions: Class B, FCC Part 15, Class B

PROPRIETARY INFORMATION

PROPRIETARY OF GLOBTEK, INC. ANY REPRODUCTION, DISCLOSURE OR USE OF THIS DRAWING, IN WHOLE OR IN PART, IS HEREBY PROHIBITED EXCEPT AS SPECIFIED IN WRITING BY GLOBTEK, INC. © GlobTek, Inc. 2019 - 2023

GlobTek, Inc. www.globtek.com 186 Veterans Drive, Northvale, NJ 07647 Tel. (201) 784-1000 Fax (201) 784-0111	Drawing Title: GTM96600-6512-P2, ICT / ITE / Medical Power Supply/Class 2/Household Power Supply, Efficiency Level: USA DOE Level VI / Eco-design Directive 2009/125/EC, (EU) 2019/1782, Case Color/Style: GlobTek Black, Potted/Encapsulated in plastic housing, Regulated Switchmode AC-DC Power Supply AC Adaptor, Input Rating: 100-240V~, 50-60 Hz, Lead Wires , Output Rating: 65W, 12.0V@5.41A, Output Configuration: 1500 mm, 18/2 Cond, H05RN-F (OR EQUIVALENT OUTDOOR CABLE), T-plug system (includes 5.5x2.5, 5.5x2.1, 3.5x1.3mm plugs in each kit), Ferrite: Core Size: 26 x 28.5 x 16, GlobTek Black, GT Cord # C52501, Pin Out: Polarity Configuration T00 All plugs are Medical Grade, Locking, Polarized once installed, and single use only. Product demonstration link: https://en.globtek.com/news/t00-changeable-output-plug-system-for-power-supplies MOLDED CONNECTORS AVAILABLE, Blades/Input Cord: IEC60320-C8 Universal Fixed Input Cord: 2 Conductor, H05RN-F 0.75mm 2C, 1830 mm, Black, terminated in an inline IEC60320/C8 IEC inlet, Approvals: CB 60950; CB 62368; CE; China RoHS; Double Insulation; EAC; cETLus 60601-1; IP68; PSE; PSE; PSE; Level VI; LPS 60950; RCM; Ukraine; VCCI; WEEE; cETLus UL1310 (36V only); UKCA; S-Mark IEC/EN 60601-1; CB 61158; Morocco; GEMS (5V) pending; RCM 5V (pending);FCC; Korea (5V On	
	Model No. GTM96600-6512-P2	
	Part No./Ordering No. PR9KE5416T00-IMR6B	Rev C

<p>Line Frequency Harmonics EN61000-3-2, Class A Voltage Fluctuations/Flicker EN61000-3-3</p> <p>Immunity, per EN 55024, EN 61000-6-1, EN 61000-6-2 Static Discharge Immunity EN61000-4-2, 10kV Contact Discharge, 20kV air discharge Radiated RF Immunity EN61000-4-3, 10V/m 80-1000MHz, 3V/m 1-2.7GHz, 80% 1KHz AM. EFT/Burst Immunity EN61000-4-4, 4kV/100kHz. Line Surge Immunity EN61000-4-5, 2kV differential, 4kV common-mode Conducted RF Immunity EN61000-4-6, 3Vrms, 80% 1KHz AM Power Frequency Magnetic Field Immunity EN61000-4-8, 3A/m Voltage Dip Immunity EN61000-4-11, Criteria</p> <p>E) OTHER: 01. MTBF: 1,000,000 Hours @ 40°C ambient temperature, Full Load 02. GTM96600 Family: -20°C to 40°C ambient temperature with full load Regarding Operating Temperature, a- See below derating table for output power capability at alternate temperature b- Extended low end temperature range available as custom option 03. Operating Humidity: 0% to 95% relative humidity, non-condensing 04. Storage Temperature: -30°C to 80°C 05. Operating Altitude: 5000 Meters 06. Ingress Protection: IP40 standard, IP52 available as special option 07. ROHS: Compliant with latest regulations, see approvals section below</p> <p>F) ENCLOSURE 01. Housing: High impact plastic, 94V0 polycarbonate, non-vented 02. Markings: Label or Laser Printed 03. AC Input mechanical options: Desktop C6, C8, C14 or C18 IEC Inlet. Hybrid option (Desktop or Changeable Blade Wall Plug-in) Class I or Class II input</p> <p>G) SPECIAL OPTIONS 01. Cost reduction, removal of LED 02. Custom Cordsets, various cordage types, and connector types 03. Custom Markings 04. Short term Output Surge Capability 05. Reduced Leakage Current versions 06. Tightened output voltage tolerance 07. Reduced output ripple level 08. Reduced output power rating marking 09. High Rel PCB laminate with Plated through Holes for IPC610 Class 2 Compliance 10. Low Temperature operation, down to -40°C 11. Special Housing Colors and Cordset Colors</p> <p>H) OUTPUT CONNECTORS Several output connector options are available with various output current ratings. GlobTek can supply 10A rated 2.1mm and 2.5mm style DC Power Jacks, to complement our 10A output rated 2.1mm and 2.5mm DC power plugs used on our output cordsets. Please visit https://en.globtek.com/news/high-current-coaxial-barrel-plug-jacks-for-high-wattage-power-supplies for a real time product offering of</p>

<p>GlobTek, Inc. www.globtek.com 186 Veterans Drive, Northvale, NJ 07647 Tel. (201) 784-1000 Fax (201) 784-0111</p>	<p>Drawing Title: GTM96600-6512-P2, ICT / ITE / Medical Power Supply/Class 2/Household Power Supply, Efficiency Level: USA DOE Level VI / Eco-design Directive 2009/125/EC, (EU) 2019/1782, Case Color/Style: GlobTek Black, Potted/Encapsulated in plastic housing, Regulated Switchmode AC-DC Power Supply AC Adaptor, Input Rating: 100-240V~, 50-60 Hz, Lead Wires , Output Rating: 65W, 12.0V@5.41A, Output Configuration: 1500 mm, 18/2 Cond, H05RN-F (OR EQUIVALENT OUTDOOR CABLE), T-plug system (includes 5.5x2.5, 5.5x2.1, 3.5x1.3mm plugs in each kit), Ferrite: Core Size: 26 x 28.5 x 16, GlobTek Black, GT Cord # C52501, Pin Out: Polarity Configuration T00 All plugs are Medical Grade, Locking, Polarized once installed, and single use only. Product demonstration link: https://en.globtek.com/news/t00-changeable-output-plug-system-for-power-supplies MOLDED CONNECTORS AVAILABLE, Blades/Input Cord: IEC60320-C8 Universal Fixed Input Cord: 2 Conductor, H05RN-F 0.75mm 2C, 1830 mm, Black, terminated in an inline IEC60320/C8 IEC inlet, Approvals: CB 60950; CB 62368; CE; China RoHS; Double Insulation; EAC; cETLus 60601-1; IP68; PSE; PSE; PSE; Level VI; LPS 60950; RCM; Ukraine; VCCI; WEEE; cETLus UL1310 (36V only); UKCA; S-Mark IEC/EN 60601-1; CB 61158; Morocco; GEMS (5V) pending; RCM 5V (pending);FCC; Korea (5V On</p>	
	<p>Model No. GTM96600-6512-P2</p>	
	<p>Part No./Ordering No. PR9KE5416T00-IMR6B</p>	<p>Rev C</p>

mating connectors.

TO ADDRESS SYSTEM-LEVEL EMI CONCERNS, FERRITE CHOKES/BEADS MAY BE ADDED/REVISED UPON REQUEST. A SAMPLE KIT OF GLOBTEK'S STANDARD FERRITES IS AVAILABLE UNDER GLOBTEK P/N: EMI-MITIGATION-KIT1

FOR ADDITIONAL INFORMATION, PLEASE READ OUR WHITE PAPER AT: <https://r.globtek.info/3QeaqtD>

INGRESS PROTECTION: IP68

GlobTek, Inc.
 www.globtek.com
 186 Veterans Drive,
 Northvale, NJ 07647
 Tel. (201) 784-1000
 Fax (201) 784-0111

Drawing Title: GTM96600-6512-P2, ICT / ITE / Medical Power Supply/Class 2/Household Power Supply, Efficiency Level: USA DOE Level VI / Eco-design Directive 2009/125/EC, (EU) 2019/1782, Case Color/Style: GlobTek Black, Potted/Encapsulated in plastic housing, Regulated Switchmode AC-DC Power Supply AC Adaptor, Input Rating: 100-240V~, 50-60 Hz, Lead Wires , Output Rating: 65W, 12.0V@5.41A, Output Configuration: 1500 mm, 18/2 Cond, H05RN-F (OR EQUIVALENT OUTDOOR CABLE), T-plug system (includes 5.5x2.5, 5.5x2.1, 3.5x1.3mm plugs in each kit), Ferrite: Core Size: 26 x 28.5 x 16, GlobTek Black, GT Cord # C52501, Pin Out: Polarity Configuration T00 All plugs are Medical Grade, Locking, Polarized once installed, and single use only. Product demonstration link: <https://en.globtek.com/news/t00-changeable-output-plug-system-for-power-supplies> MOLDED CONNECTORS AVAILABLE, Blades/Input Cord: IEC60320-C8 Universal Fixed Input Cord: 2 Conductor, H05RN-F 0.75mm 2C, 1830 mm, Black, terminated in an inline IEC60320/C8 IEC inlet, Approvals: CB 60950; CB 62368; CE; China RoHS; Double Insulation; EAC; cETLus 60601-1; IP68; PSE; PSE; PSE; Level VI; LPS 60950; RCM; Ukraine; VCCI; WEEE; cETLus UL1310 (36V only); UKCA; S-Mark IEC/EN 60601-1; CB 61158; Morocco; GEMS (5V) pending; RCM 5V (pending);FCC; Korea (5V On

Model No. GTM96600-6512-P2

Part No./Ordering No. PR9KE5416T00-IMR6B

Rev C

3D File Download https://en.globtek.com/file/dl/GTM96600-65VV.V-P2_SR_with_fixed_Plug_2_pin.zip

Mechanical drawing

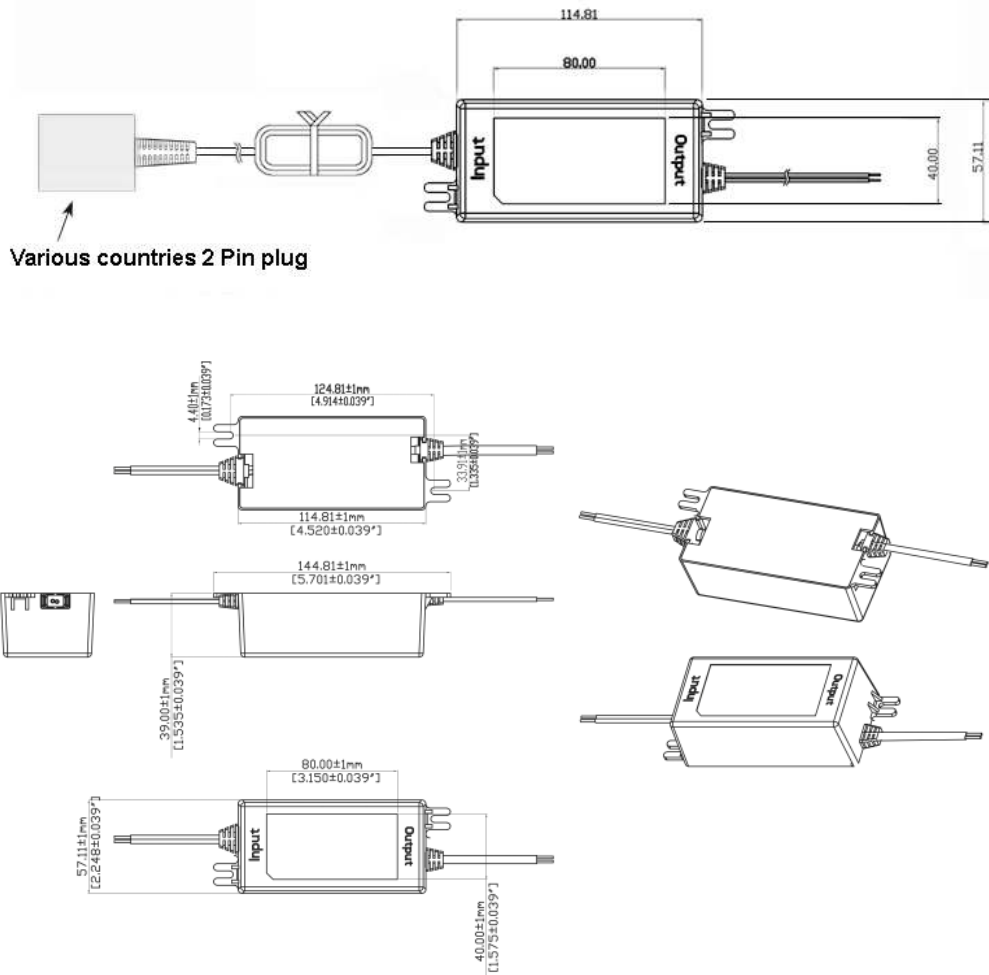

GlobTek, Inc.
 www.globtek.com
 186 Veterans Drive,
 Northvale, NJ 07647
 Tel. (201) 784-1000
 Fax (201) 784-0111

Drawing Title: GTM96600-6512-P2, ICT / ITE / Medical Power Supply/Class 2/Household Power Supply, Efficiency Level: USA DOE Level VI / Eco-design Directive 2009/125/EC, (EU) 2019/1782, Case Color/Style: GlobTek Black, Potted/Encapsulated in plastic housing, Regulated Switchmode AC-DC Power Supply AC Adaptor, Input Rating: 100-240V~, 50-60 Hz, Lead Wires , Output Rating: 65W, 12.0V@5.41A, Output Configuration: 1500 mm, 18/2 Cond, H05RN-F (OR EQUIVALENT OUTDOOR CABLE), T-plug system (includes 5.5x2.5, 5.5x2.1, 3.5x1.3mm plugs in each kit), Ferrite: Core Size: 26 x 28.5 x 16, GlobTek Black, GT Cord # C52501, Pin Out: Polarity Configuration T00 All plugs are Medical Grade, Locking, Polarized once installed, and single use only. Product demonstration link: <https://en.globtek.com/news/t00-changeable-output-plug-system-for-power-supplies> MOLDED CONNECTORS AVAILABLE, Blades/Input Cord: IEC60320-C8 Universal Fixed Input Cord: 2 Conductor, H05RN-F 0.75mm 2C, 1830 mm, Black, terminated in an inline IEC60320/C8 IEC inlet, Approvals: CB 60950; CB 62368; CE; China RoHS; Double Insulation; EAC; cETLus 60601-1; IP68; PSE; PSE; PSE; Level VI; LPS 60950; RCM; Ukraine; VCCI; WEEE; cETLus UL1310 (36V only); UKCA; S-Mark IEC/EN 60601-1; CB 61158; Morocco; GEMS (5V) pending; RCM 5V (pending);FCC; Korea (5V On

Model No. GTM96600-6512-P2

Part No./Ordering No. PR9KE5416T00-IMR6B

Rev C

DERATING CURVE

**TYPICAL EXTERNAL POWER SUPPLY
 DERATING CURVE**
 (FOR EFFICIENCY LEVEL V AND EFFICIENCY LEVEL VI PRODUCTS)

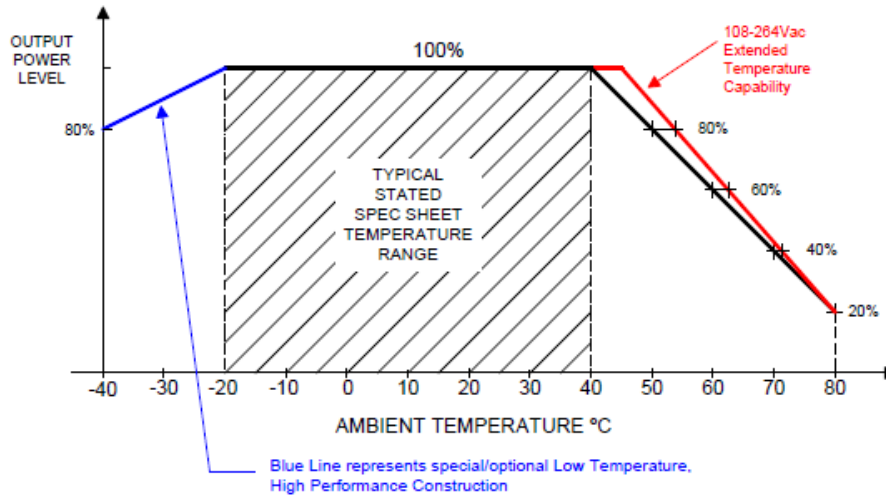

<p>GlobTek, Inc. www.globtek.com 186 Veterans Drive, Northvale, NJ 07647 Tel. (201) 784-1000 Fax (201) 784-0111</p>	<p>Drawing Title: GTM96600-6512-P2, ICT / ITE / Medical Power Supply/Class 2/Household Power Supply, Efficiency Level: USA DOE Level VI / Eco-design Directive 2009/125/EC, (EU) 2019/1782, Case Color/Style: GlobTek Black, Potted/Encapsulated in plastic housing, Regulated Switchmode AC-DC Power Supply AC Adaptor, Input Rating: 100-240V~, 50-60 Hz, Lead Wires , Output Rating: 65W, 12.0V@5.41A, Output Configuration: 1500 mm, 18/2 Cond, H05RN-F (OR EQUIVALENT OUTDOOR CABLE), T-plug system (includes 5.5x2.5, 5.5x2.1, 3.5x1.3mm plugs in each kit), Ferrite: Core Size: 26 x 28.5 x 16, GlobTek Black, GT Cord # C52501, Pin Out: Polarity Configuration T00 All plugs are Medical Grade, Locking, Polarized once installed, and single use only. Product demonstration link: https://en.globtek.com/news/t00-changeable-output-plug-system-for-power-supplies MOLDED CONNECTORS AVAILABLE, Blades/Input Cord: IEC60320-C8 Universal Fixed Input Cord: 2 Conductor, H05RN-F 0.75mm 2C, 1830 mm, Black, terminated in an inline IEC60320/C8 IEC inlet, Approvals: CB 60950; CB 62368; CE; China RoHS; Double Insulation; EAC; cETLus 60601-1; IP68; PSE; PSE; PSE; Level VI; LPS 60950; RCM; Ukraine; VCCI; WEEE; cETLus UL1310 (36V only); UKCA; S-Mark IEC/EN 60601-1; CB 61158; Morocco; GEMS (5V) pending; RCM 5V (pending);FCC; Korea (5V On</p>	
	<p>Model No. GTM96600-6512-P2</p>	
	<p>Part No./Ordering No. PR9KE5416T00-IMR6B</p>	<p>Rev C</p>

INPUT CONFIGURATION

(F1) Class II / Double Insulated

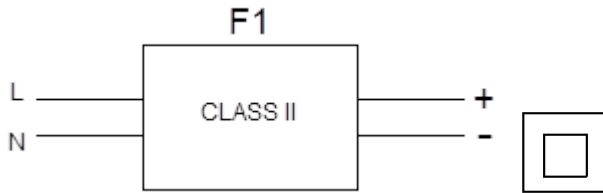

[Alternate grounding configurations](#) available upon request.

Blades/Cord Included:FC-IEC2-1830-Rubber:IEC60320-C8 Universal Fixed Input Cord: 2 Conductor, H05RN-F 0.75mm 2C, 1830 mm, Black, terminated in an inline IEC60320/C8 IEC inlet

<p>GlobTek, Inc. www.globtek.com 186 Veterans Drive, Northvale, NJ 07647 Tel. (201) 784-1000 Fax (201) 784-0111</p>	<p>Drawing Title: GTM96600-6512-P2, ICT / ITE / Medical Power Supply/Class 2/Household Power Supply, Efficiency Level: USA DOE Level VI / Eco-design Directive 2009/125/EC, (EU) 2019/1782, Case Color/Style: GlobTek Black, Potted/Encapsulated in plastic housing, Regulated Switchmode AC-DC Power Supply AC Adaptor, Input Rating: 100-240V~, 50-60 Hz, Lead Wires , Output Rating: 65W, 12.0V@5.41A, Output Configuration: 1500 mm, 18/2 Cond, H05RN-F (OR EQUIVALENT OUTDOOR CABLE), T-plug system (includes 5.5x2.5, 5.5x2.1, 3.5x1.3mm plugs in each kit), Ferrite: Core Size: 26 x 28.5 x 16, GlobTek Black, GT Cord # C52501, Pin Out: Polarity Configuration T00 All plugs are Medical Grade, Locking, Polarized once installed, and single use only. Product demonstration link: https://en.globtek.com/news/t00-changeable-output-plug-system-for-power-supplies MOLDED CONNECTORS AVAILABLE, Blades/Input Cord: IEC60320-C8 Universal Fixed Input Cord: 2 Conductor, H05RN-F 0.75mm 2C, 1830 mm, Black, terminated in an inline IEC60320/C8 IEC inlet, Approvals: CB 60950; CB 62368; CE; China RoHS; Double Insulation; EAC; cETLus 60601-1; IP68; PSE; PSE; PSE; Level VI; LPS 60950; RCM; Ukraine; VCCI; WEEE; cETLus UL1310 (36V only); UKCA; S-Mark IEC/EN 60601-1; CB 61158; Morocco; GEMS (5V) pending; RCM 5V (pending);FCC; Korea (5V On</p>	
	<p>Model No. GTM96600-6512-P2</p>	
	<p>Part No./Ordering No. PR9KE5416T00-IMR6B</p>	<p>Rev C</p>

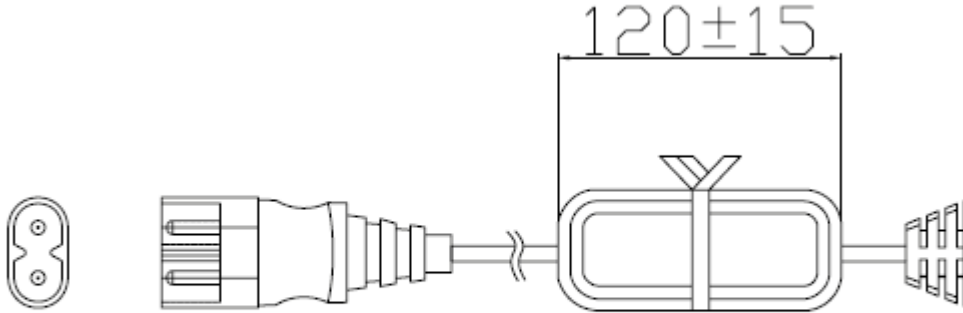

For use with GlobTek input [power cords](#) or the below international plug adapters for easy global deployment(to be ordered separately unless indicated otherwise elsewhere in the spec):

Part
Number/Ordering Description
Number

207-703R(R)	PLUG ADAPTOR STRAIGHT EUROPLUG TYPE C EN50075 (CEE 7/16) TO CONNECTOR IEC 60320/C7
207R-703R(R)	PLUG ADAPTOR DOWN ANGLE EUROPLUG TYPE C EN50075 (CEE 7/16) TO CONNECTOR IEC 60320/C7
451-703R(R)	PLUG ADAPTOR STRAIGHT TYPE A NEMA 1-15P TO CONNECTOR IEC 60320/C7
451R-703R(R)	PLUG ADAPTER DOWN ANGLE TYPE A NEMA 1-15P TO CONNECTOR IEC 60320/C7
501-703R(R)	PLUG ADAPTOR STRAIGHT TYPE I AUSTRALIA AS/NZS 3112 TO CONNECTOR IEC 60320/C7
501R-703R(R)	AUSTRALIA DOWN ANGLE TYPE I AS/NZS 3112 RIGHT ANGLE TO CONNECTOR IEC 60320/C7
610-703R(R)	PLUG ADAPTOR STRAIGHT TYPE G UK BS1363 TO CONNECTOR IEC 60320/C7
610R-703R(R)	PLUG ADAPTER DOWN ANGLE TYPE G UK BS1363, RIGHT ANGLE TO CONNECTOR IEC 60320/C7

Blades/Cord Installed:N/A:Not Applicable

See "Blade/Cord Installed" section.

Contact GlobTek for customization requests such as Molded country plugs, Molex or TE connectors, or IEC connectors mounted on any type of cable in any customer specified lengths.

GlobTek, Inc. www.globtek.com 186 Veterans Drive, Northvale, NJ 07647 Tel. (201) 784-1000 Fax (201) 784-0111	Drawing Title: GTM96600-6512-P2, ICT / ITE / Medical Power Supply/Class 2/Household Power Supply, Efficiency Level: USA DOE Level VI / Eco-design Directive 2009/125/EC, (EU) 2019/1782, Case Color/Style: GlobTek Black, Potted/Encapsulated in plastic housing, Regulated Switchmode AC-DC Power Supply AC Adaptor, Input Rating: 100-240V~, 50-60 Hz, Lead Wires , Output Rating: 65W, 12.0V@5.41A, Output Configuration: 1500 mm, 18/2 Cond, H05RN-F (OR EQUIVALENT OUTDOOR CABLE), T-plug system (includes 5.5x2.5, 5.5x2.1, 3.5x1.3mm plugs in each kit), Ferrite: Core Size: 26 x 28.5 x 16, GlobTek Black, GT Cord # C52501, Pin Out: Polarity Configuration T00 All plugs are Medical Grade, Locking, Polarized once installed, and single use only. Product demonstration link: https://en.globtek.com/news/t00-changeable-output-plug-system-for-power-supplies MOLDED CONNECTORS AVAILABLE, Blades/Input Cord: IEC60320-C8 Universal Fixed Input Cord: 2 Conductor, H05RN-F 0.75mm 2C, 1830 mm, Black, terminated in an inline IEC60320/C8 IEC inlet, Approvals: CB 60950; CB 62368; CE; China RoHS; Double Insulation; EAC; cETLus 60601-1; IP68; PSE; PSE; PSE; Level VI; LPS 60950; RCM; Ukraine; VCCI; WEEE; cETLus UL1310 (36V only); UKCA; S-Mark IEC/EN 60601-1; CB 61158; Morocco; GEMS (5V) pending; RCM 5V (pending);FCC; Korea (5V On	
	Model No. GTM96600-6512-P2	
	Part No./Ordering No. PR9KE5416T00-IMR6B	Rev C

OUTPUT CORD AND CONNECTOR:	T00/C52501
ACTUAL CONNECTORS, OVERMOLDS, FERRITES MAY VARY SLIGHTLY FROM THE PICTURE BELOW	
CABLE TYPE	H05RN-F (OR EQUIVALENT OUTDOOR CABLE)
CABLE LENGTH (mm)	1500
CABLE TOLERANCE (mm)	± 50
WIRE GAUGE (AWG)	18
CONDUCTORS	2
HANK DIMENSION (mm)	80 ± 10
CABLE / CONNECTOR OVERMOLD COLOR	GlobTek Black
FERRITE TYPE AND DIMENSION	Core Size: 26 x 28.5 x 16
FERRITE NUMBER OF TURNS(Definition)	2 Pass thru core (1 turns)
FERRITE DIMENSION FROM STRAIN RELIEF	50±10
FERRITE DIMENSION FROM PLUG	N/A
PLUG TYPE	T-plug system (includes 5.5x2.5, 5.5x2.1, 3.5x1.3mm plugs in each kit)
OUTPUT CONNECTOR GENDER	Female
OVERMOLDED	Yes
OVER MOLD ORIENTATION	Straight
CONNECTOR PIN OUT	Polarity Configuration T00 All plugs are Medical Grade, Locking, Polarized once installed, and single use only. Product demonstration link: https://en.globtek.com/news/t00-changeable-output-plug-system-for-power-supplies
	MOLDED CONNECTORS AVAILABLE
ADDITIONAL REQUIREMENTS	Cable material shall be rated for outdoor use
<p>This novel system allows for rapid shipment of prototype samples or small quantities of common output voltage and current which can fulfill the needs of most common barrel plug specs. The table below explains the standard and non standard options available as part of this system. This system also allows for both Center Positive and Center Negative polarity.</p> <p>The T00 plug and adapters are Medical Grade, single use only, Polarized after installation, and not removable without use of special tool.</p> <p>Any of the below options, and more, are available as molded plugs from stock or special order. Please contact GlobTek for more information</p>	

GlobTek, Inc.
 www.globtek.com
 186 Veterans Drive,
 Northvale, NJ 07647
 Tel. (201) 784-1000
 Fax (201) 784-0111

Drawing Title: GTM96600-6512-P2, ICT / ITE / Medical Power Supply/Class 2/Household Power Supply, Efficiency Level: USA DOE Level VI / Eco-design Directive 2009/125/EC, (EU) 2019/1782, Case Color/Style: GlobTek Black, Potted/Encapsulated in plastic housing, Regulated Switchmode AC-DC Power Supply AC Adaptor, Input Rating: 100-240V~, 50-60 Hz, Lead Wires , Output Rating: 65W, 12.0V@5.41A, Output Configuration: 1500 mm, 18/2 Cond, H05RN-F (OR EQUIVALENT OUTDOOR CABLE), T-plug system (includes 5.5x2.5, 5.5x2.1, 3.5x1.3mm plugs in each kit), Ferrite: Core Size: 26 x 28.5 x 16, GlobTek Black, GT Cord # C52501, Pin Out: Polarity Configuration T00 All plugs are Medical Grade, Locking, Polarized once installed, and single use only. Product demonstration link: <https://en.globtek.com/news/t00-changeable-output-plug-system-for-power-supplies> MOLDED CONNECTORS AVAILABLE, Blades/Input Cord: IEC60320-C8 Universal Fixed Input Cord: 2 Conductor, H05RN-F 0.75mm 2C, 1830 mm, Black, terminated in an inline IEC60320/C8 IEC inlet, Approvals: CB 60950; CB 62368; CE; China RoHS; Double Insulation; EAC; cETLus 60601-1; IP68; PSE; PSE; PSE; Level VI; LPS 60950; RCM; Ukraine; VCCI; WEEE; cETLus UL1310 (36V only); UKCA; S-Mark IEC/EN 60601-1; CB 61158; Morocco; GEMS (5V) pending; RCM 5V (pending);FCC; Korea (5V On

Model No. GTM96600-6512-P2

Part No./Ordering No. PR9KE5416T00-IMR6B

Rev C

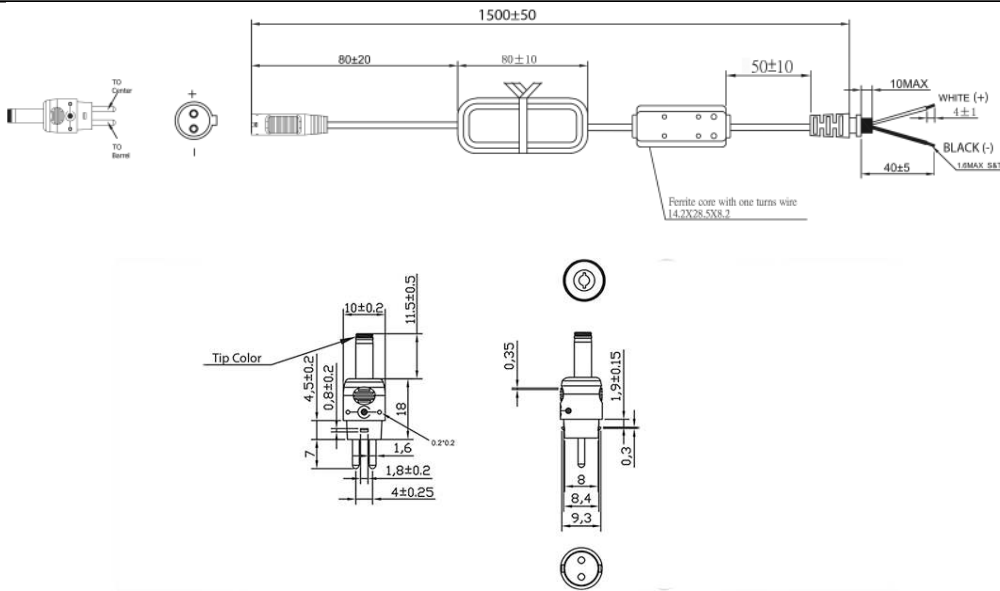

Option upon request: STRAIGHT Female Barrels are available for special order in any length between 9mm-14mm

This novel system allows for rapid shipment of prototype samples or small quantities of common output voltage and current which can fulfill the needs of most common barrel plug as well as male plug specs. The table explains the standard and non-standard options available as part of this system. This system also allows for both Center Positive and Center Negative polarity.

The T00 plug and adapters are Medical Grade, single use only, Polarized after installation, and not removable without use of special tool.

Please [click here](#) and review [usage guidance](#) below before use.

Any of the below options, and more, are available as molded plugs from stock or special order. Please contact GlobTek for more information

ADDITIONAL OUTPUT PLUG OPTIONS ARE AVAILABLE AT <https://www.globtek.com/connectors/>

STANDARD PLUGS AND CONNECTORS CAN BE SEEN ONLINE AT <https://www.globtek.com/connectors/>

CALCULATE VOLTAGE REGULATION/DROP WITH OUR ONLINE CALCULATOR: <https://en.globtek.com/output-cable-regulation-calculator/>

<p>GlobTek, Inc. www.globtek.com 186 Veterans Drive, Northvale, NJ 07647 Tel. (201) 784-1000 Fax (201) 784-0111</p>	<p>Drawing Title: GTM96600-6512-P2, ICT / ITE / Medical Power Supply/Class 2/Household Power Supply, Efficiency Level: USA DOE Level VI / Eco-design Directive 2009/125/EC, (EU) 2019/1782, Case Color/Style: GlobTek Black, Potted/Encapsulated in plastic housing, Regulated Switchmode AC-DC Power Supply AC Adaptor, Input Rating: 100-240V~, 50-60 Hz, Lead Wires , Output Rating: 65W, 12.0V@5.41A, Output Configuration: 1500 mm, 18/2 Cond, H05RN-F (OR EQUIVALENT OUTDOOR CABLE), T-plug system (includes 5.5x2.5, 5.5x2.1, 3.5x1.3mm plugs in each kit), Ferrite: Core Size: 26 x 28.5 x 16, GlobTek Black, GT Cord # C52501, Pin Out: Polarity Configuration T00 All plugs are Medical Grade, Locking, Polarized once installed, and single use only. Product demonstration link: https://en.globtek.com/news/t00-changeable-output-plug-system-for-power-supplies MOLDED CONNECTORS AVAILABLE, Blades/Input Cord: IEC60320-C8 Universal Fixed Input Cord: 2 Conductor, H05RN-F 0.75mm 2C, 1830 mm, Black, terminated in an inline IEC60320/C8 IEC inlet, Approvals: CB 60950; CB 62368; CE; China RoHS; Double Insulation; EAC; cETLus 60601-1; IP68; PSE; PSE; PSE; Level VI; LPS 60950; RCM; Ukraine; VCCI; WEEE; cETLus UL1310 (36V only); UKCA; S-Mark IEC/EN 60601-1; CB 61158; Morocco; GEMS (5V) pending; RCM 5V (pending);FCC; Korea (5V On</p>	
	<p>Model No. GTM96600-6512-P2</p>	
	<p>Part No./Ordering No. PR9KE5416T00-IMR6B</p>	<p>Rev C</p>

OUTPUT CONNECTOR HOOK UP

TO ADDRESS SYSTEM-LEVEL EMI CONCERNS, FERRITE CHOKES/BEADS MAY BE ADDED/REVISED UPON REQUEST. A SAMPLE KIT OF GLOBTEK'S STANDARD FERRITES IS AVAILABLE UNDER GLOBTEK P/N: EMI-MITIGATION-KIT1

FOR ADDITIONAL INFORMATION, PLEASE READ OUR WHITE PAPER AT:

<https://en.globtek.com/technical-articles/ferrite-kit-radiated-emi-suppression-kit-for-globtek-power-supplies-cable-assemblies>

GlobTek, Inc. www.globtek.com 186 Veterans Drive, Northvale, NJ 07647 Tel. (201) 784-1000 Fax (201) 784-0111	Drawing Title: GTM96600-6512-P2, ICT / ITE / Medical Power Supply/Class 2/Household Power Supply, Efficiency Level: USA DOE Level VI / Eco-design Directive 2009/125/EC, (EU) 2019/1782, Case Color/Style: GlobTek Black, Potted/Encapsulated in plastic housing, Regulated Switchmode AC-DC Power Supply AC Adaptor, Input Rating: 100-240V~, 50-60 Hz, Lead Wires , Output Rating: 65W, 12.0V@5.41A, Output Configuration: 1500 mm, 18/2 Cond, H05RN-F (OR EQUIVALENT OUTDOOR CABLE), T-plug system (includes 5.5x2.5, 5.5x2.1, 3.5x1.3mm plugs in each kit), Ferrite: Core Size: 26 x 28.5 x 16, GlobTek Black, GT Cord # C52501, Pin Out: Polarity Configuration T00 All plugs are Medical Grade, Locking, Polarized once installed, and single use only. Product demonstration link: https://en.globtek.com/news/t00-changeable-output-plug-system-for-power-supplies MOLDED CONNECTORS AVAILABLE, Blades/Input Cord: IEC60320-C8 Universal Fixed Input Cord: 2 Conductor, H05RN-F 0.75mm 2C, 1830 mm, Black, terminated in an inline IEC60320/C8 IEC inlet, Approvals: CB 60950; CB 62368; CE; China RoHS; Double Insulation; EAC; cETLus 60601-1; IP68; PSE; PSE; PSE; Level VI; LPS 60950; RCM; Ukraine; VCCI; WEEE; cETLus UL1310 (36V only); UKCA; S-Mark IEC/EN 60601-1; CB 61158; Morocco; GEMS (5V) pending; RCM 5V (pending);FCC; Korea (5V On	
	Model No. GTM96600-6512-P2	
	Part No./Ordering No. PR9KE5416T00-IMR6B	Rev C

LABEL:L-1470

LABEL P/N	ISO 15223 medical device compliant label
MATERIAL	Flat Thermal Transfer, Imprintable, Polyester Label and/or Pad Printed and/or Molded, and/or Laser Engraved in the case
BACKGROUND COLOR	Black if housing is Black, White or Silver if housing is White or Gray.
TEXT COLOR	White or Silver if label is Black Background for Black housing. Black if label is White or Silver background and Housing is White or Gray.
LABEL WIDTH (mm)	79.5
LABEL HEIGHT (mm)	39.5
SPECIAL BARCODE LABEL MATERIAL	No

Below is the minimum information which will appear on the label. NOTE: in the logo area additional/actual positioning of symbols and text is subjected to change as per agency updates/requirements or additional model approvals become available.

Agency logos may be in Regulatory Certifications/Label Markings area on the label or molded into the case housing outside the label area. Information will be shown via Label and/or Pad Printed and/or Molded in the case.

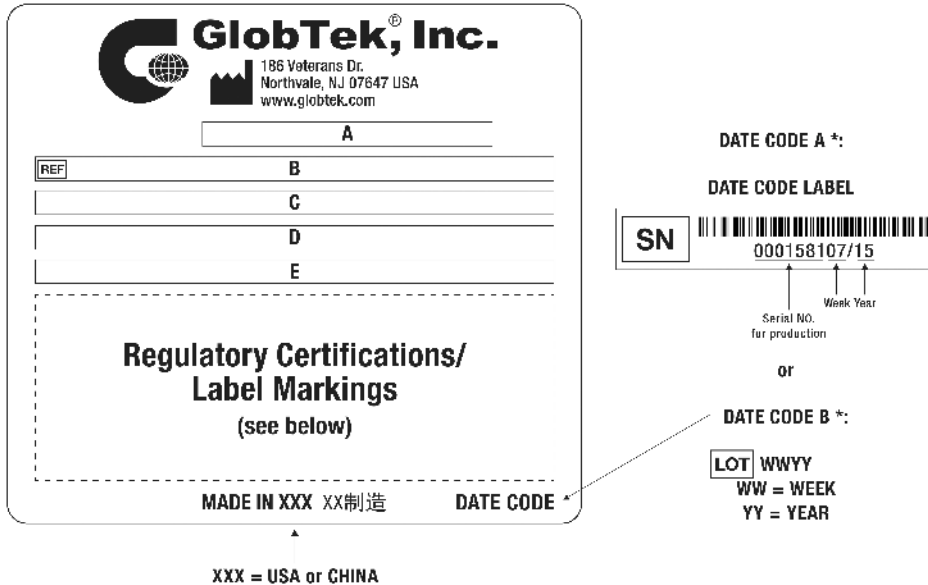

A=ICT / ITE / Medical Power Supply/Class 2/Household Power Supply
 B=P/N: (料号) PR9KE5416T00-IMR6B
 C=Model (型号) GTM96600-6512-P2
 D=Input (输入)100-240V~, 50-60 Hz, 1.5A
 E=Output (输出)12.0 V  5.41 A, 65.00W

GlobTek, Inc. www.globtek.com 186 Veterans Drive, Northvale, NJ 07647 Tel. (201) 784-1000 Fax (201) 784-0111	Drawing Title: GTM96600-6512-P2, ICT / ITE / Medical Power Supply/Class 2/Household Power Supply, Efficiency Level: USA DOE Level VI / Eco-design Directive 2009/125/EC, (EU) 2019/1782, Case Color/Style: GlobTek Black, Potted/Encapsulated in plastic housing, Regulated Switchmode AC-DC Power Supply AC Adaptor, Input Rating: 100-240V~, 50-60 Hz, Lead Wires , Output Rating: 65W, 12.0V@5.41A, Output Configuration: 1500 mm, 18/2 Cond, H05RN-F (OR EQUIVALENT OUTDOOR CABLE), T-plug system (includes 5.5x2.5, 5.5x2.1, 3.5x1.3mm plugs in each kit), Ferrite: Core Size: 26 x 28.5 x 16, GlobTek Black, GT Cord # C52501, Pin Out: Polarity Configuration T00 All plugs are Medical Grade, Locking, Polarized once installed, and single use only. Product demonstration link: https://en.globtek.com/news/t00-changeable-output-plug-system-for-power-supplies MOLDED CONNECTORS AVAILABLE, Blades/Input Cord: IEC60320-C8 Universal Fixed Input Cord: 2 Conductor, H05RN-F 0.75mm 2C, 1830 mm, Black, terminated in an inline IEC60320/C8 IEC inlet, Approvals: CB 60950; CB 62368; CE; China RoHS; Double Insulation; EAC; cETLus 60601-1; IP68; PSE; PSE; PSE; Level VI; LPS 60950; RCM; Ukraine; VCCI; WEEE; cETLus UL1310 (36V only); UKCA; S-Mark IEC/EN 60601-1; CB 61158; Morocco; GEMS (5V) pending; RCM 5V (pending);FCC; Korea (5V On	
	Model No. GTM96600-6512-P2	
	Part No./Ordering No. PR9KE5416T00-IMR6B	Rev C

AGENCY ONLINE DOCUMENTS	http://www.globtek.info/certs/GTM96600-TZ/
CE EC-Declaration for Medical	http://globtek.force.com/models/ec_declaration_product?id=01t0c0000097qIR&m=1
CE EC-Declaration for Industrial/Commercial/ITE	http://globtek.force.com/models/ec_declaration_product?id=01t0c0000097qIR&i=2
CE EC-Declaration for Household	http://globtek.force.com/models/ec_declaration_product?id=01t0c0000097qIR&h=2
UKCA-Declaration for Medical	http://globtek.force.com/models/ukca_declaration_product?id=01t0c0000097qIR&m=1
UKCA-Declaration for Industrial/Commercial/ITE	http://globtek.force.com/models/ukca_declaration_product?id=01t0c0000097qIR&i=2
UKCA-Declaration for Household	http://globtek.force.com/models/ukca_declaration_product?id=01t0c0000097qIR&h=2
Morocco SDoC Declaration	https://globtek.secure.force.com/models/Morocco_SDoC_Declaration?id=a000c00000Q0hRKEAZ
RoHS/RoHS3 Declaration	https://www.globtek.com/pdf/rohs_cert/01t0c0000097qIRAAQ
REACH Declaration	https://www.globtek.com/pdf/iso_certificates/REACH.pdf
Conflict Minerals Declaration	https://www.globtek.com/pdf/conflict-minerals.pdf
Prop 65 Statement	https://en.globtek.com/prop-65-statement.pdf

IPXY rating is based on 3rd party testing and customers should check suitability and test system level IPXY rating before ordering.

Regulatory Certifications/Label Markings

Below follows a link to the latest regulatory certifications and marks for this specific product. National standards as well as certification schemes are constantly changing and so is the set of certification marks and symbols applicable to this product. Various standards, marks and symbols, and certificates are subject to change at any time without notice.

Additional standards or unique country certifications are available upon request. Please contact Globtek to request a quotation.

LATEST PRODUCT/MODEL CERTIFICATIONS: <https://www.globtek.com/datasheet/w70384>

AGENCY ONLINE DOCUMENTS <http://www.globtek.info/certs/GTM96600-TZ/>



(F1) Class II / Double Insulated



Polarity Configuration T00 All plugs are Medical Grade, Locking, Polarized once installed, and single use only.

Product demonstration link:

<https://en.globtek.com/news/t00-changeable-output-plug-system-for-power-s>

MOLDED CONNECTORS AVAILABLE

GlobTek, Inc. www.globtek.com 186 Veterans Drive, Northvale, NJ 07647 Tel. (201) 784-1000 Fax (201) 784-0111	Drawing Title: GTM96600-6512-P2, ICT / ITE / Medical Power Supply/Class 2/Household Power Supply, Efficiency Level: USA DOE Level VI / Eco-design Directive 2009/125/EC, (EU) 2019/1782, Case Color/Style: GlobTek Black, Potted/Encapsulated in plastic housing, Regulated Switchmode AC-DC Power Supply AC Adaptor, Input Rating: 100-240V~, 50-60 Hz, Lead Wires , Output Rating: 65W, 12.0V@5.41A, Output Configuration: 1500 mm, 18/2 Cond, H05RN-F (OR EQUIVALENT OUTDOOR CABLE), T-plug system (includes 5.5x2.5, 5.5x2.1, 3.5x1.3mm plugs in each kit), Ferrite: Core Size: 26 x 28.5 x 16, GlobTek Black, GT Cord # C52501, Pin Out: Polarity Configuration T00 All plugs are Medical Grade, Locking, Polarized once installed, and single use only. Product demonstration link: https://en.globtek.com/news/t00-changeable-output-plug-system-for-power-supplies MOLDED CONNECTORS AVAILABLE, Blades/Input Cord: IEC60320-C8 Universal Fixed Input Cord: 2 Conductor, H05RN-F 0.75mm 2C, 1830 mm, Black, terminated in an inline IEC60320/C8 IEC inlet, Approvals: CB 60950; CB 62368; CE; China RoHS; Double Insulation; EAC; cETLus 60601-1; IP68; PSE; PSE; PSE; Level VI; LPS 60950; RCM; Ukraine; VCCI; WEEE; cETLus UL1310 (36V only); UKCA; S-Mark IEC/EN 60601-1; CB 61158; Morocco; GEMS (5V) pending; RCM 5V (pending);FCC; Korea (5V On	
	Model No. GTM96600-6512-P2	
	Part No./Ordering No. PR9KE5416T00-IMR6B	Rev C

PACKAGING

Packing Spec P/N	Cell packing for DT plug model with T00 plug and manual
Box Qty	27
Gift Box Size (mm)	Egg Crate
Gift Box Color	White
Master Carton Size (mm)	545 x 485 x 250
Master Carton Cubic Volume (m³)	0.07
Master GW (Kg)	20.3 kg
BLADES INCLUDED	FC-IEC2-1830-Rubber: IEC60320-C8 Universal Fixed Input Cord: 2 Conductor, H05RN-F 0.75mm 2C, 1830 mm, Black, terminated in an inline IEC60320/C8 IEC inlet
BLADE/CORD INSTALLED	N/A: Not Applicable
USER MANUAL*	809-DESKTOPUSERMANUAL on A4 paper
USER MANUAL WEB LINK	https://en.globtek.com/pdf/809-DESKTOPUSERMANUAL.jpg

* This specification sheet is considered the user manual for all applications. It is expected that the buyer of this product will use it to formulate their own user manual for their end product and a user manual specifically for the power adapter is not usually required. If a user manual is not specifically listed above then none will be provided with this unit.

If specific packaging is required, this section must specify all requirements and note "no exceptions". If this section does not specify packaging, it is subject to change without notice at GlobTek's discretion.

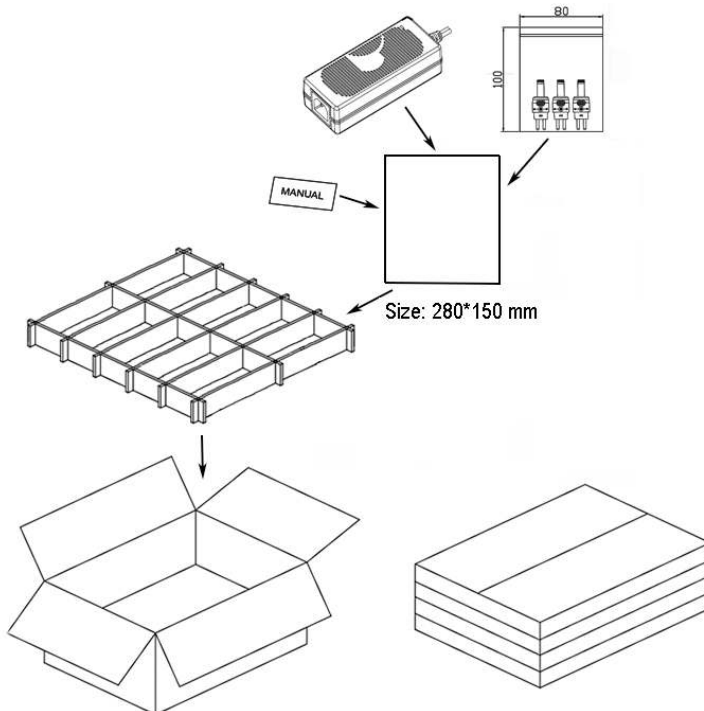

PROPRIETARY INFORMATION

PROPRIETARY OF GLOBTEK, INC. ANY REPRODUCTION, DISCLOSURE OR USE OF THIS DRAWING, IN WHOLE OR IN PART, IS HEREBY PROHIBITED EXCEPT AS SPECIFIED IN Page 16 of 20

WRITING BY GLOBTEK, INC. © GlobTek, Inc. 2019 - 2023

quest / 08/11/2023 7:21:56 PM GMT

<p>GlobTek, Inc. www.globtek.com 186 Veterans Drive, Northvale, NJ 07647 Tel. (201) 784-1000 Fax (201) 784-0111</p>	<p>Drawing Title: GTM96600-6512-P2, ICT / ITE / Medical Power Supply/Class 2/Household Power Supply, Efficiency Level: USA DOE Level VI / Eco-design Directive 2009/125/EC, (EU) 2019/1782, Case Color/Style: GlobTek Black, Potted/Encapsulated in plastic housing, Regulated Switchmode AC-DC Power Supply AC Adaptor, Input Rating: 100-240V~, 50-60 Hz, Lead Wires , Output Rating: 65W, 12.0V@5.41A, Output Configuration: 1500 mm, 18/2 Cond, H05RN-F (OR EQUIVALENT OUTDOOR CABLE), T-plug system (includes 5.5x2.5, 5.5x2.1, 3.5x1.3mm plugs in each kit), Ferrite: Core Size: 26 x 28.5 x 16, GlobTek Black, GT Cord # C52501, Pin Out: Polarity Configuration T00 All plugs are Medical Grade, Locking, Polarized once installed, and single use only. Product demonstration link: https://en.globtek.com/news/t00-changeable-output-plug-system-for-power-supplies MOLDED CONNECTORS AVAILABLE, Blades/Input Cord: IEC60320-C8 Universal Fixed Input Cord: 2 Conductor, H05RN-F 0.75mm 2C, 1830 mm, Black, terminated in an inline IEC60320/C8 IEC inlet, Approvals: CB 60950; CB 62368; CE; China RoHS; Double Insulation; EAC; cETLus 60601-1; IP68; PSE; PSE; PSE; Level VI; LPS 60950; RCM; Ukraine; VCCI; WEEE; cETLus UL1310 (36V only); UKCA; S-Mark IEC/EN 60601-1; CB 61158; Morocco; GEMS (5V) pending; RCM 5V (pending);FCC; Korea (5V On</p>	
	<p>Model No. GTM96600-6512-P2</p>	
	<p>Part No./Ordering No. PR9KE5416T00-IMR6B</p>	<p>Rev C</p>

Manual for T00-plug: WHITE BACKGROUND WITH BLACK TEXT

GlobTek, Inc.
 T-Plug Instructions
 • Color of Plug indicates Approval Status
 • Refer to the website www.globtek.com for more information

PART NO	DIAMETER		LENGTH	TIP COLOR
	OUTER	INNER		
TC-12-50R	5.2	2.1	12	YELLOW
TR-12-50R	5.5	2.5	12	BLACK
TR-11-80R	3.2	1.2	11	BLADE
TR-12-35-50R	4.0	1.7	35	BROWN
TR-12-35-50R	4.74	1.7	35	RED
TR-12-35-50R	5.1	3.3	35	ORANGE
TR-12-35-50R	2.25	0.7	35	YELLOW
TR-12-115-50R	6.5	3.9	115	BLACK
TR-12-115-50R	3.5	-	14	-
TR-12-115-50R	3.2	-	14	-
TR-12-115-50R	2.5	-	11	-
TR-12-115-50R	2.2	-	11	-

Dimensions: 80mm+0/-0.2 (width), 90mm+0/-0.2 (height)

SHEET A

Plugs can only be inserted one time
Molded options available upon request

Dimensions: 80mm+0/-0.2 (width), 90mm+0/-0.2 (height)

Text: Arial Bold/18pt

SHEET B

<p>GlobTek, Inc. www.globtek.com 186 Veterans Drive, Northvale, NJ 07647 Tel. (201) 784-1000 Fax (201) 784-0111</p>	<p>Drawing Title: GTM96600-6512-P2, ICT / ITE / Medical Power Supply/Class 2/Household Power Supply, Efficiency Level: USA DOE Level VI / Eco-design Directive 2009/125/EC, (EU) 2019/1782, Case Color/Style: GlobTek Black, Potted/Encapsulated in plastic housing, Regulated Switchmode AC-DC Power Supply AC Adaptor, Input Rating: 100-240V~, 50-60 Hz, Lead Wires , Output Rating: 65W, 12.0V@5.41A, Output Configuration: 1500 mm, 18/2 Cond, H05RN-F (OR EQUIVALENT OUTDOOR CABLE), T-plug system (includes 5.5x2.5, 5.5x2.1, 3.5x1.3mm plugs in each kit), Ferrite: Core Size: 26 x 28.5 x 16, GlobTek Black, GT Cord # C52501, Pin Out: Polarity Configuration T00 All plugs are Medical Grade, Locking, Polarized once installed, and single use only. Product demonstration link: https://en.globtek.com/news/t00-changeable-output-plug-system-for-power-supplies MOLDED CONNECTORS AVAILABLE, Blades/Input Cord: IEC60320-C8 Universal Fixed Input Cord: 2 Conductor, H05RN-F 0.75mm 2C, 1830 mm, Black, terminated in an inline IEC60320/C8 IEC inlet, Approvals: CB 60950; CB 62368; CE; China RoHS; Double Insulation; EAC; cETLus 60601-1; IP68; PSE; PSE; PSE; Level VI; LPS 60950; RCM; Ukraine; VCCI; WEEE; cETLus UL1310 (36V only); UKCA; S-Mark IEC/EN 60601-1; CB 61158; Morocco; GEMS (5V) pending; RCM 5V (pending);FCC; Korea (5V On</p>		
	<p>Model No. GTM96600-6512-P2</p>		
	<table border="1"> <tr> <td data-bbox="300 459 1377 459">Part No./Ordering No. PR9KE5416T00-IMR6B</td> <td data-bbox="1377 459 1557 459">Rev C</td> </tr> </table>	Part No./Ordering No. PR9KE5416T00-IMR6B	Rev C
Part No./Ordering No. PR9KE5416T00-IMR6B	Rev C		

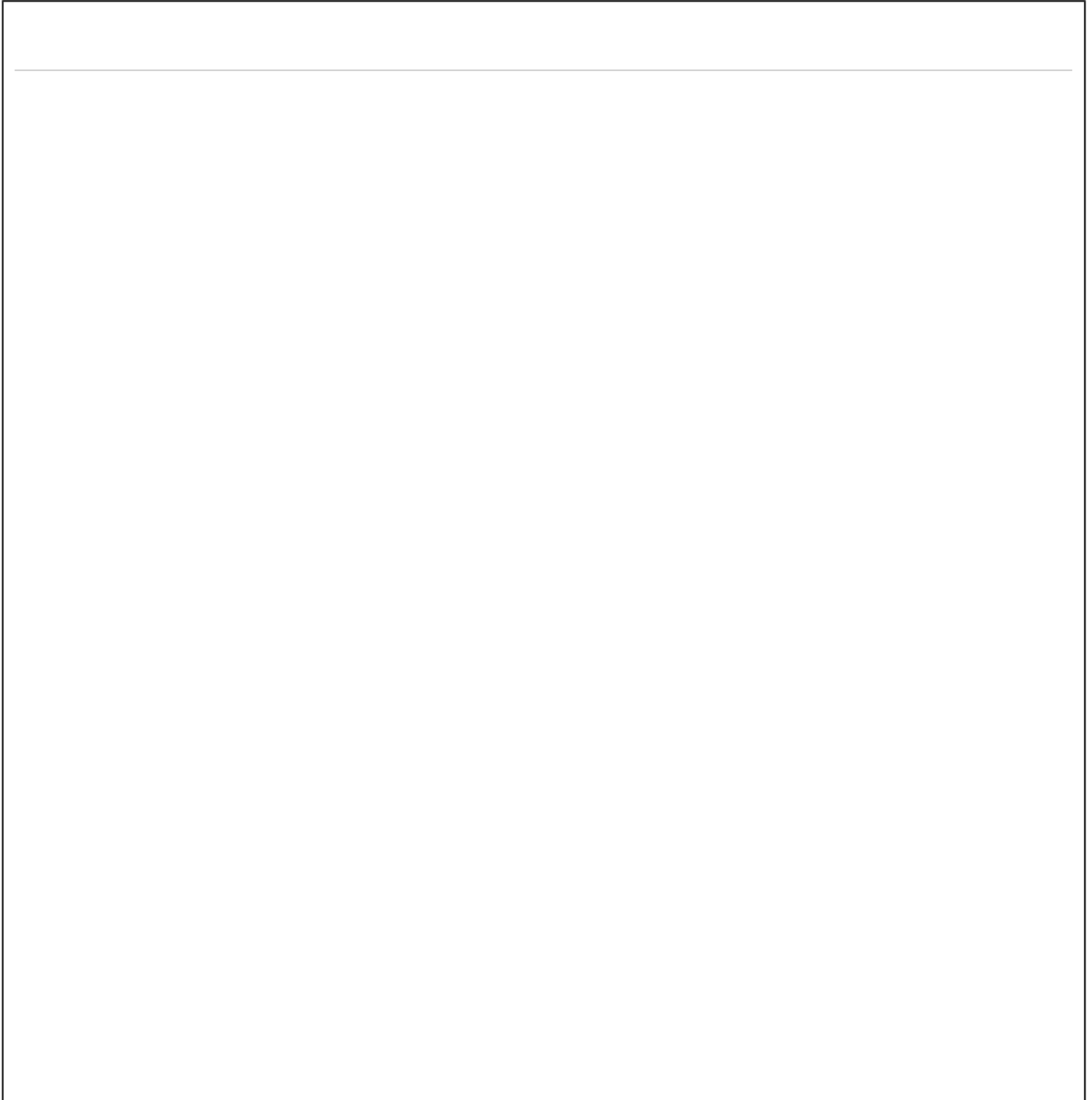

GlobTek, Inc. www.globtek.com 186 Veterans Drive, Northvale, NJ 07647 Tel. (201) 784-1000 Fax (201) 784-0111	Drawing Title: GTM96600-6512-P2, ICT / ITE / Medical Power Supply/Class 2/Household Power Supply, Efficiency Level: USA DOE Level VI / Eco-design Directive 2009/125/EC, (EU) 2019/1782, Case Color/Style: GlobTek Black, Potted/Encapsulated in plastic housing, Regulated Switchmode AC-DC Power Supply AC Adaptor, Input Rating: 100-240V~, 50-60 Hz, Lead Wires , Output Rating: 65W, 12.0V@5.41A, Output Configuration: 1500 mm, 18/2 Cond, H05RN-F (OR EQUIVALENT OUTDOOR CABLE), T-plug system (includes 5.5x2.5, 5.5x2.1, 3.5x1.3mm plugs in each kit), Ferrite: Core Size: 26 x 28.5 x 16, GlobTek Black, GT Cord # C52501, Pin Out: Polarity Configuration T00 All plugs are Medical Grade, Locking, Polarized once installed, and single use only. Product demonstration link: https://en.globtek.com/news/t00-changeable-output-plug-system-for-power-supplies MOLDED CONNECTORS AVAILABLE, Blades/Input Cord: IEC60320-C8 Universal Fixed Input Cord: 2 Conductor, H05RN-F 0.75mm 2C, 1830 mm, Black, terminated in an inline IEC60320/C8 IEC inlet, Approvals: CB 60950; CB 62368; CE; China RoHS; Double Insulation; EAC; cETLus 60601-1; IP68; PSE; PSE; PSE; Level VI; LPS 60950; RCM; Ukraine; VCCI; WEEE; cETLus UL1310 (36V only); UKCA; S-Mark IEC/EN 60601-1; CB 61158; Morocco; GEMS (5V) pending; RCM 5V (pending);FCC; Korea (5V On	
	Model No. GTM96600-6512-P2	
	Part No./Ordering No. PR9KE5416T00-IMR6B	Rev C

INSTRUCTIONS TO THE OEM SYSTEMS ENGINEER

It is the responsibility of the OEM systems engineer to provide the end system user instructions and warnings for the use of this product in the end system.

If an input cord is required for this product, AC Mains voltage should be provided to the power supply by a power supply cord approved to the national standards of the country in which it will be used.

This product is not designed to be repaired. No serviceable parts inside. A blown internal fuse is an indication of catastrophic failure of circuit component(s). If a Failure Analysis is required for a failed power supply/battery charger, please return the damaged unit to GlobTek for an accurate determination of the root cause of the failure.

EMC Compliance of the complete OEM product, including the GlobTek power supply/battery charger needs to be verified by the OEM systems engineer.

INSTRUCTION SHEET

N/A

<p>GlobTek, Inc. www.globtek.com 186 Veterans Drive, Northvale, NJ 07647 Tel. (201) 784-1000 Fax (201) 784-0111</p>	<p>Drawing Title: GTM96600-6512-P2, ICT / ITE / Medical Power Supply/Class 2/Household Power Supply, Efficiency Level: USA DOE Level VI / Eco-design Directive 2009/125/EC, (EU) 2019/1782, Case Color/Style: GlobTek Black, Potted/Encapsulated in plastic housing, Regulated Switchmode AC-DC Power Supply AC Adaptor, Input Rating: 100-240V~, 50-60 Hz, Lead Wires , Output Rating: 65W, 12.0V@5.41A, Output Configuration: 1500 mm, 18/2 Cond, H05RN-F (OR EQUIVALENT OUTDOOR CABLE), T-plug system (includes 5.5x2.5, 5.5x2.1, 3.5x1.3mm plugs in each kit), Ferrite: Core Size: 26 x 28.5 x 16, GlobTek Black, GT Cord # C52501, Pin Out: Polarity Configuration T00 All plugs are Medical Grade, Locking, Polarized once installed, and single use only. Product demonstration link: https://en.globtek.com/news/t00-changeable-output-plug-system-for-power-supplies MOLDED CONNECTORS AVAILABLE, Blades/Input Cord: IEC60320-C8 Universal Fixed Input Cord: 2 Conductor, H05RN-F 0.75mm 2C, 1830 mm, Black, terminated in an inline IEC60320/C8 IEC inlet, Approvals: CB 60950; CB 62368; CE; China RoHS; Double Insulation; EAC; cETLus 60601-1; IP68; PSE; PSE; PSE; Level VI; LPS 60950; RCM; Ukraine; VCCI; WEEE; cETLus UL1310 (36V only); UKCA; S-Mark IEC/EN 60601-1; CB 61158; Morocco; GEMS (5V) pending; RCM 5V (pending);FCC; Korea (5V On</p>		
	<p>Model No. GTM96600-6512-P2</p>		
	<table border="1"> <tr> <td data-bbox="300 459 1377 459">Part No./Ordering No. PR9KE5416T00-IMR6B</td> <td data-bbox="1377 459 1557 459">Rev C</td> </tr> </table>	Part No./Ordering No. PR9KE5416T00-IMR6B	Rev C
Part No./Ordering No. PR9KE5416T00-IMR6B	Rev C		

