



MAX1385 Evaluation Kit/Evaluation System

General Description

The MAX1385 evaluation kit (EV kit) is an assembled and tested PCB that demonstrates the MAX1385 dual RF LDMOS bias controller. The accompanying Windows® 2000/XP-compatible software provides a handy user interface to exercise the features of the MAX1385.

The MAX1385 evaluation system (EV system) includes the MAX1385 EV kit, a high-speed I²C interface module (HSI2CMOD), and a 68HC16 microcontroller (μC) module (68HC16MODULE-DIP). Order the complete EV system for comprehensive evaluation of the MAX1385 using a PC. Order the EV kit if the 68HC16MODULE-DIP module has already been purchased with a previous Maxim EV system, or for custom use in other μC-based systems.

The EV kit comes with the MAX1385 installed, but can also be used to evaluate the MAX1386.

Windows is a registered trademark of Microsoft Corp.

Features

- ◆ Demonstrates a Simple V_{gs} (Temperature) Lookup Control Loop
- ◆ 68HC16 Assembly Source Code Included
- ◆ Proven PCB Layout
- ◆ Complete Evaluation System
- ◆ Data-Logging Software
- ◆ Lead(Pb)-Free and RoHS Compliant

Ordering Information

PART	TYPE	INTERFACE
MAX1385EVKIT+	EV kit	User-provided I ² C interface
MAX1385EVC16	EV system	Windows PC with RS-232 serial port

+Denotes lead(Pb)-free and RoHS compliant.

Note: The MAX1385 EV kit software is included with the MAX1385 EV kit, but is designed for use with the complete EV system. The EV system includes both the 68HC16MODULE-DIP and HSI2CMOD modules and the EV kit. If the Windows software will not be used, the MAX1385 EV kit board can be purchased by itself, without the μC.

Component Lists

MAX1385 EV System

PART	QTY	DESCRIPTION
MAX1385EVKIT+	1	MAX1385 EV kit
HSI2CMOD	1	High-speed I ² C interface module
68HC16MODULE-DIP	1	68HC16 μC module

MAX1385 EV Kit

DESIGNATION	QTY	DESCRIPTION
C1, C4, C8, C10, C12, C16	6	1.0μF ±10%, 10V X5R ceramic capacitors (0603) TDK C1608X5R1A105K
C2, C5, C9, C11, C13, C14, C15, C28, C29	9	0.1μF ±20%, 50V X7R ceramic capacitors (0603) TDK C1608X7R1H104M
		0.1μF ±20%, 16V X7R ceramic capacitors (0603) TDK C1608X7R1C104M
		0.1μF ±10%, 16V X7R ceramic capacitors (0603) TDK C1608X7R1C104K

MAX1385 EV Kit (continued)

DESIGNATION	QTY	DESCRIPTION
C3, C18	2	1.0μF ±20%, 25V X5R ceramic capacitors (0603) TDK C1608X5R1E105M
		1.0μF ±20%, 25V X7R ceramic capacitors (0603) TDK C1608X7R1E105M
		1.0μF ±10%, 25V X7R ceramic capacitors (0603) TDK C1608X7R1E105K
C6, C7	0	Not installed; ceramic capacitors (0603)
C17	1	10μF ±20%, 25V X7R ceramic capacitor (1210) TDK C3225X7R1E106M
C19	1	4.7μF ±20%, 6.3V X5R ceramic capacitor (0603) TDK C1608X5R0J475M
C20–C23	4	100pF ±5%, 50V C0G ceramic capacitors (0603) TDK C1608C0G1H101J TDK C1608C0G1H101K

Evaluate: MAX1385/MAX1386

MAX1385 Evaluation Kit/Evaluation System

Component Lists

MAX1385 EV Kit (continued)

DESIGNATION	QTY	DESCRIPTION
D1	1	Red LED
J1	1	20-pin, 2 x 10 right-angle female receptacle
JU0, JU1, JU2, JU10, JU11	5	3-pin headers
JU3-JU9, JU12-JU21	17	2-pin headers
L1	1	70Ω, 4A ferrite bead (0603) Murata BLM18SG700 TN1
M1, M2	2	nFET (TO-220AB) Vds = 55V (High Vds --> Low GM) Rdson = 0.024Ω at Vgs = 10V Id = 29A at 100°C International Rectifier IRFZ44NPBF
R1	1	680Ω ±5% resistor (0603)
R2, R3	2	1kΩ ±1% resistors (1206)
R4	1	0Ω resistor (0603)

DESIGNATION	QTY	DESCRIPTION
R5, R9	2	4.99kΩ ±1% resistors (1206)
R7, R8	2	0.1Ω ±1% sense resistors (2010) IRC LRC-LR2010LF-01-R100-F DALE WSL2010R1000FEA
R10, R11	2	0Ω resistors (1206)
R12, R13	2	100Ω ±5% resistors (1206)
R14, R15	2	47Ω ±5% resistors (1206)
U1	1	MAX1385BETM+ (48 Thin QFN-EP, 7mm x 7mm x 0.8mm)
U2	1	MAX6126AASA25+ +2.5V voltage reference (8 SO)
U3	1	MAX1615EUK+T +28V input linear regulator (Top Mark: ABZD)
U4, U5	2	nnp transistors (3 SOT23) Fairchild MMBT3904 (Top Mark: 1A)
—	22	Shunts
—	1	PCB: MAX1385EVKIT+

Component Suppliers

SUPPLIER	PHONE	FAX	WEBSITE
Fairchild Semiconductor	888-522-5372	Local rep only	www.fairchildsemi.com
International Rectifier	310-322-3331	310-726-8721	www.irf.com
IRC, Inc.	361-992-7900	361-992-3377	www.irctt.com
TDK Corp.	847-803-6100	847-390-4405	www.component.tdk.com
Vishay/Dale	402-564-3131	402-563-6296	www.vishay.com

Note: Indicate that you are using the MAX1385 when contacting these component suppliers.

Quick Start

Required Equipment

See Figure 1 for system connections:

- 8V, 500mA DC power supply
- 10V, 1000mA DC power supply
- MAX1385 EV system:
 - MAX1385 EV kit
 - High-speed I²C interface module
 - 68HC16 μC module

- A user-supplied Windows 2000/XP PC with a spare serial (COM) port
- 9-pin I/O extension cable

Note: In the following sections, software-related items are identified by bolding. Text in **bold** refers to items directly from the EV kit software. Text in **bold and underlined** refers to items from the Windows operating system.

MAX1385 Evaluation Kit/Evaluation System

Procedure

The MAX1385 EV kit is fully assembled and tested. Follow the steps below to verify board operation.

Caution: Do not turn on the power until all connections are made.

- 1) Ensure that the MAX1385 EV kit jumpers are set in accordance with Table 1.
- 2) Carefully connect the boards by aligning the 40-pin header of the HSI2CMOD with the 40-pin connector of the 68HC16MODULE-DIP module. Gently press them together. The two boards should be flush against one another. Next, connect the MAX1385 EV kit 20-pin connector to the HSI2CMOD board.
- 3) Connect the 8VDC power source to the 68HC16MODULE-DIP module at the terminal block located next to the ON/OFF switch, along the top edge of the module. Observe the polarity marked on the board.
- 4) Connect a cable from the computer's serial port to the 68HC16MODULE-DIP module. If using a 9-pin serial port, use a straight-through, 9-pin female-to-male cable. If the only available serial port uses a 25-pin connector, a standard 25-pin to 9-pin adapter will be required. The EV kit software checks the modem status lines (CTS, DSR, and DCD) to confirm that the correct port has been selected.
- 5) Visit the Maxim website (www.maxim-ic.com/evkitsoftware) to download the latest version of the EV kit software. Install the MAX1385 evaluation software on your computer by launching 1385Rxx.msi. The program files are copied and icons are created in the Windows **Start** menu.
- 6) Turn on the 8VDC power supply.
- 7) Start the MAX1385 EV kit program by opening its icon in the **Start** menu.
- 8) Accept the default system parameters by clicking the **Next** button, as shown in Figure 2.
- 9) The software establishes communications with the 68HC16MODULE-DIP and HSI2CMOD boards. The program prompts you to connect the μ C module and turn its power on. Slide SW1 to the ON position. Select the correct serial port, and click **OK**. The program automatically downloads its software to the module. During connection, you will be asked to move the HSI2CMOD Rev A board's jumper JU5.
- 10) Wait until the software enters **Open-Loop System Checkout** mode (Figure 3).
- 11) Turn on the 10V DC power supply.
- 12) Click the **Start Calibration** button. Successful calibration results in a total of approximately 250mA drain current.

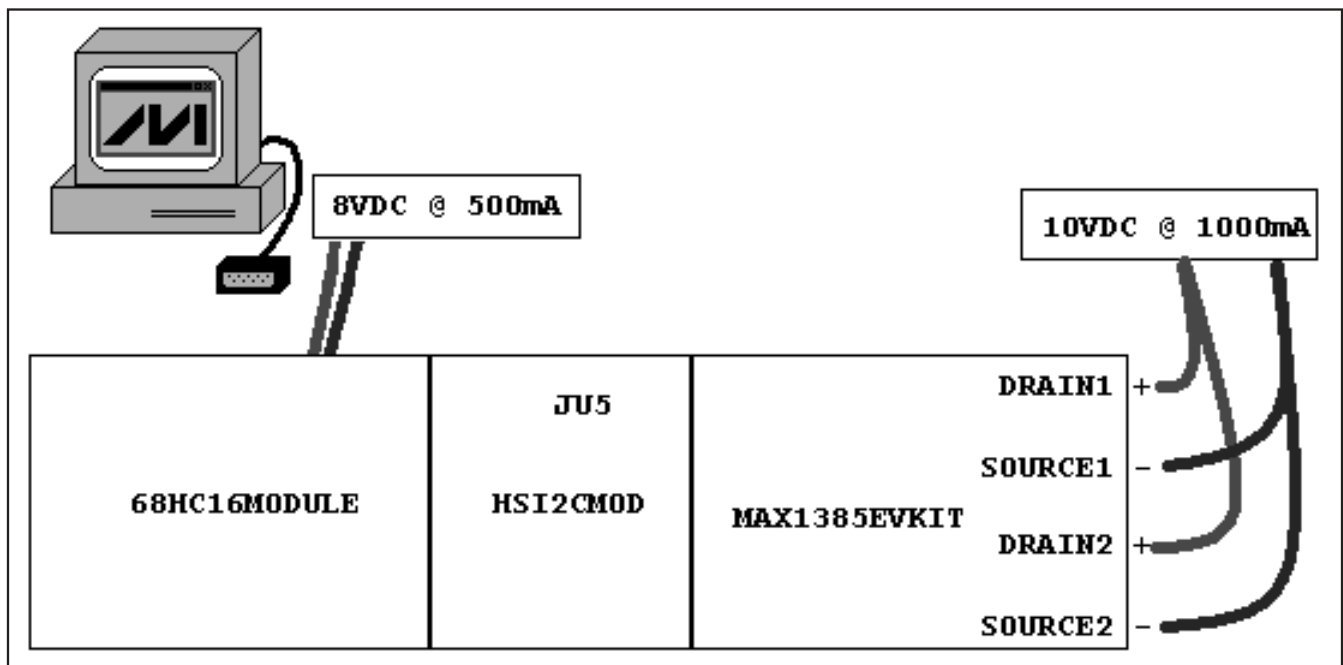

Figure 1. MAX1385 EV Kit System Connections

MAX1385 Evaluation Kit/Evaluation System

Maxim MAX1385 Evaluation Kit

File Options View Help

This software demonstrates a MAX1385 regulating one or two LDMOS FETs IDq over Temperature.
Enter system parameters, then proceed to Calibration...

Ideal Vgs vs T: IRFZ44N_125mA.txt
Device: MAX1385: Gate Gain = 2 V/V

1/2 MAX1385

Drain Supply

RCS +
RCS -
ADCIN
DXP
DXN
SAFE
OPSAFE
GATE
GATEGND

PGA
V
T
Im < I < IM
Tm < T < TM
f(T)

IDq

MAX1385 Global Configuration

ALARM output pin: FAIL=High, OK=Low

Alarm Comparator / Interrupt Mode: 1: Release as soon as condition clears

Built-in hysteresis (window mode alarm limits): 8 LSB

ADC Conversion Start Trigger: 00: Conv reg write

ADC Reference Voltage Source: 00: External

DAC Reference Voltage Source: 00: External

Parameters are valid, click Next to proceed

Unlock Next >>

Step 1: System Parameter Selection | Step 2: Calibration and Regulation | Hardware Connection

firmware: --- no hardware address: --- Alarm: --- alarm flags unknown

Use Channel 1 **Use Channel 2**

CH1 FET parameters

Target Drain Current (IDq): 0.125 A

Gate Drive (Vgs) range: 2.000 V 4.500 V

CH1 Current Sense Resistor (Rcs): 0.100 ohm Vcs = 0.01250 V

PGA setting: 10: 25 V/V Vpgaout = 0.31250 V

MAX1385 CH1 Alarm Configuration

MAX1385 SAFE1 output pin: FAIL=High, OK=Low

Temperature: 00 ignore

Low Limit: -40.0 °C High Limit: 85.0 °C

Current: 00 ignore

Low Limit: 0.050 A High Limit: 0.135 A

CH2 FET parameters Copy all CH1 parameters

Target Drain Current (IDq): 0.125 A

Gate Drive (Vgs) range: 2.000 V 4.500 V

CH2 Current Sense Resistor (Rcs): 0.100 ohm Vcs = 0.01250 V

PGA setting: 10: 25 V/V Vpgaout = 0.31250 V

MAX1385 CH2 Alarm Configuration

MAX1385 SAFE2 output pin: FAIL=High, OK=Low

Temperature: 00 ignore

Low Limit: -40.0 °C High Limit: 85.0 °C

Current: 00 ignore

Low Limit: 0.050 A High Limit: 0.135 A

Figure 2. MAX1385 EV Kit System Parameter Selection Window

MAX1385 Evaluation Kit/Evaluation System

Evaluate: MAX1385/MAX1386

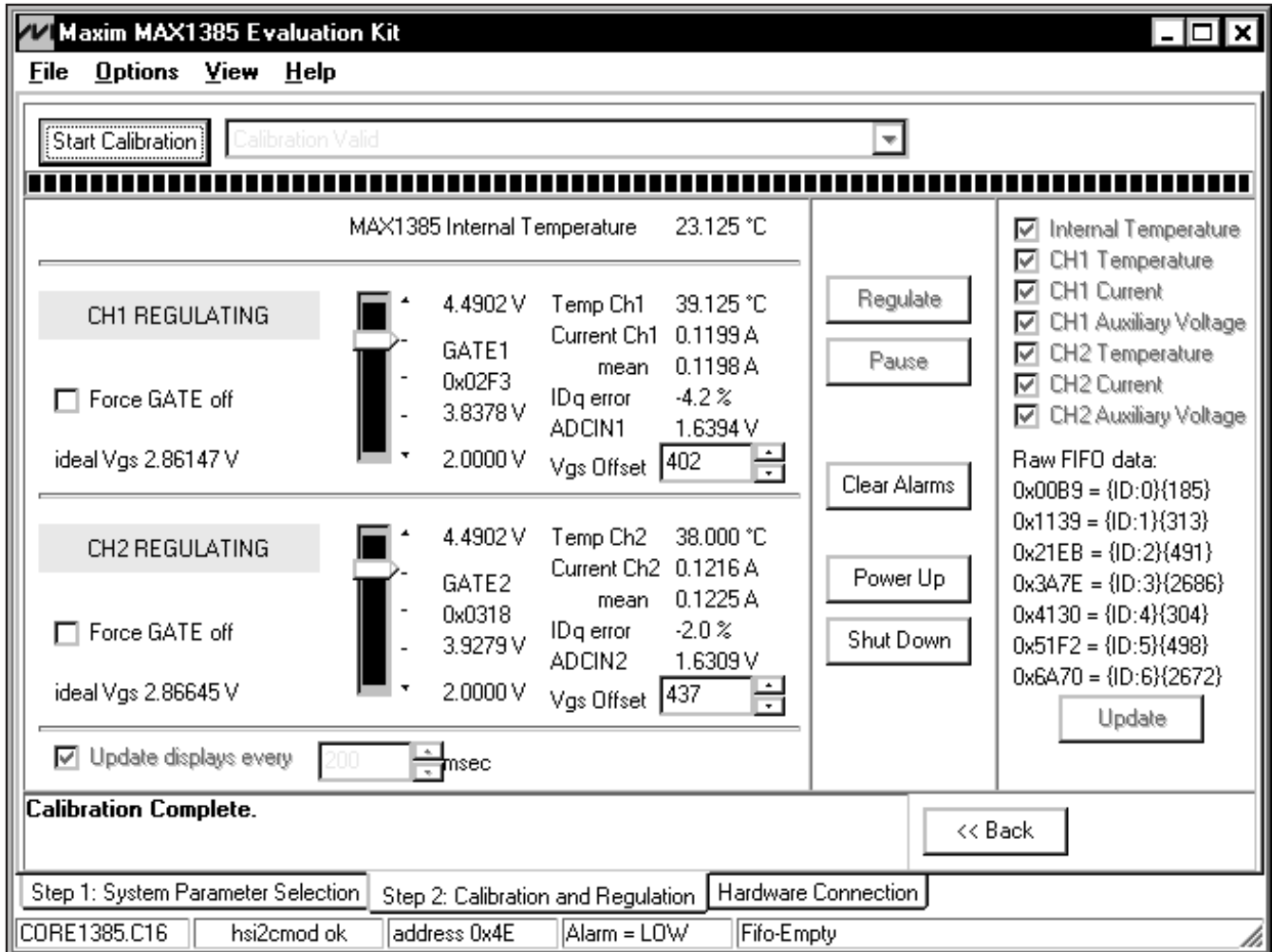

Figure 3. MAX1385 EV Kit Calibration and Regulation Window

MAX1385 Evaluation Kit/Evaluation System

Detailed Description of Software

System parameters and MAX1385 configuration settings are determined in the **Step 1: System Parameter Selection** tab (Figure 2). Invalid parameters are flagged with a red circle-slash-NO sign, and an error message appears at the bottom of the screen. If Channel 2 will be identical to Channel 1, click the **Copy all CH1 parameters** button. Once all parameters are valid, click the **Next** button to proceed to the next screen.

Power-on the 68HC16MODULE-DIP μ C and click on the **Step 2: Calibration and Regulation** tab. Executable code is loaded into the μ C, allowing access to the MAX1385 registers.

Once the μ C is loaded and the MAX1385 is initialized, **Open-Loop System Checkout** begins. Operate the **GATE1/GATE2** sliders (Figure 3) while watching the current indicator to verify that the MAX1385 is connected to the target FETs. Once the gate control, temperature, and current-measurement connections have been verified, click the **Start Calibration** button.

During calibration, the software enables the Vgs vs. Temperature regulation loop (though not at optimal speed), adjusting the Vgs (FINEDAC) code offset until the target drain current is reached.

Clicking the **Shut Down** button halts the regulation loop on the μ C. Clicking the **Power Up** button sends the sequence 0x64<— 0x0008, 0x0008 to power up the device again.

Clicking the **Regulate** button enables regulation on Channel 1 and/or Channel 2, depending on which was enabled back on the first screen. Clicking the **Pause** button disables regulation on both channels.

The **Hardware Connection** tab allows register read/write access to the MAX1385 and also the registers of the DI2CM core inside the HSI2CMOD board.

Keyboard Navigation

When you type on the keyboard, the system must know which control receives the keys. Press the **TAB** key to move the keyboard's focus from one control to the next. The focused control is indicated by a dotted outline. **SHIFT+TAB** moves the focus to the previously focused control. Buttons respond to the keyboard's **SPACE** bar. Some controls respond to the keyboard's **UP** and **DOWN** arrow keys. Activate the program's menu bar by pressing the **F10** key, and then press the letter of the menu item desired. Most menu items have one letter underlined, indicating their shortcut key.

Saving Graphs to Disk

Data in the real-time graph and in sampled data graphs may be saved to a file. Only the raw output codes are saved, but voltages may be inferred based on the reference voltage and the maximum code value.

Ideal Vgs vs. Temperature File

A small data file describing the typical Vgs voltage over temperature to produce the desired target drain current (IDq) must be created by the user. An example file is shown in Listing 1.

```
; MFGR: International Rectifier
; DEVICE: IRFZ44N
; Mean Vgs vs Temperature characteristic to
; regulate at IDq = 0.125 A
; Mean of data collected from two devices
; measured by [ts] 04/13/2005

; TEMP_C, Vgs _mean
-40.0, 3.2470
-20.0, 3.1495
0.0, 3.0550
20.0, 2.9560
40.0, 2.8565
60.0, 2.7545
80.0, 2.6475
85.0, 2.6190
```

Listing 1.

Each Vgs vs. Temperature point must be on a line by itself.

- The lines may be in any order.
- The temperature ($^{\circ}$ C) must be in the first column.
- The Vgs gate-to-source voltage (volts) must be in the second column.
- The columns may be separated by a comma.
- Spaces and tabs will be ignored.

Comments may be added to improve readability. Comments cannot be combined with data lines. The software treats the following lines as comments:

- Blank lines
- ; Lines that begin with a semicolon
- * Lines that begin with an asterisk
- / Lines that begin with a forward slash
- \ Lines that begin with a backslash

Detailed Description of Hardware

For *table-top* demonstration, two MOSFETS (M1 and M2) are provided on-board, taking the place of the LDMOS FETs, which would be used in a real application. Diode-connected BJT transistors U4 and U5 sense

MAX1385 Evaluation Kit/Evaluation System

the temperature of each FET, while remaining electrically isolated by PCB copper layers. Capacitors C20 and C21 filter the external temperature measurements. Gate drive is lowpass filtered by R14/C28 and R15/C29. Kelvin-connected precision resistors R7 and R8, filtered by R12/C22 and R13/C23, measure drain current. Drain voltage is sensed by 6:1 resistor-dividers R9/R2 and R5/R3.

Power is provided from the HSI2CMOD board connected to J1. The digital supply connects directly to 5V through jumper JU8. On-board MAX1615 regulator U3 provides the 5V analog supply through jumper JU12 and ferrite bead L1. On-board MAX6126 voltage reference U2 drives both REFADC and REFDAC through jumpers JU5 and JU6. The MAX1385 power is bypassed by capacitors C1–C5.

The complete evaluation system is a three-board set, with the 68HC16MODULE-DIP μ C driving the

HSI2CMOD board's high-speed I²C interface core. Refer to the HSI2CMOD data sheet for details.

Evaluating the MAX1386

The MAX1386 may be evaluated on the same layout as the MAX1385. The only difference is that the gate gain is 4V/V instead of 2V/V. Be sure to select the MAX1386 in the **Device** pulldown menu, as shown in Figure 2.

Evaluating the SPI™ Interface

The SPI interface is not supported by the MAX1385 EV kit software. However, the MAX1385 EV kit PCB layout supports the hardware. Set jumper JU11 to the 1-2 position. The SPI interface pins use the same pins as the MAX1385's SCL, SDA, A0, and A1 pins.

SPI is a trademark of Motorola, Inc.

Evaluate: MAX1385/MAX1386

Table 1. Jumper Settings

JUMPER	SIGNAL	SHUNT POSITION	DESCRIPTION
JU0	A0/ $\overline{\text{CSB}}$	1-2*	A0 = DVDD
		Open	Do not use
		2-3	A0 = DGND
JU1	A1/DOOUT	1-2*	A1 = DVDD
		Open	Do not use
		2-3	A1 = DGND
JU2	A2	1-2*	A2 = DVDD
		Open	Do not use
		2-3	A2 = DGND
JU3	DXP1	1-2*	The on-board 2N3904 (U4) senses temperature
		Open	An external temperature sensor may be connected between DXP1 and DXN1
JU4	DXP2	1-2*	The on-board 2N3904 (U5) senses temperature
		Open	An external temperature sensor may be connected between DXP2 and DXN2
JU5	REFADC	1-2*	REFADC = +2.5V from MAX6126
		Open	REFADC = internal reference, or user-supplied external voltage reference
JU6	REFDAC	1-2*	REFDAC = +2.5V from MAX6126
		Open	REFDAC = internal reference, or user-supplied external voltage reference
JU7	SAFE2	1-2*	SAFE2 = OPSAFE2
		Open	SAFE2 unconnected
JU8	DVDD	1-2*	DVDD = supplied from J1-1 connector
		Open	DVDD = external user-supplied power
JU9	SAFE1	1-2*	SAFE1 = OPSAFE1
		Open	SAFE1 unconnected

MAX1385 Evaluation Kit/Evaluation System

Table 1. Jumper Settings (continued)

JUMPER	SIGNAL	SHUNT POSITION	DESCRIPTION
JU10	$\overline{\text{CNVST}}$	1-2*	$\overline{\text{CNVST}} = \text{DVDD}$
		Open	$\overline{\text{CNVST}} = \text{J1-15}$
		2-3	$\overline{\text{CNVST}} = \text{DGND}$
JU11	SEL	1-2	U1-5 = DVDD = SPI interface version
		Open	Do not use
		2-3*	U1-5 = DGND = I ² C interface version
JU12	AVDD	1-2*	AVDD = +5V from MAX1615
		Open	AVDD = external user-supplied power
JU13	GATEVDD	1-2*	GATEVDD is powered by AVDD
		Open	GATEVDD must be provided by user
JU14	RCS2-	1-2*	Demo circuit RCS2- connection
		Open	Use external user-provided current-sense connection
JU15	RCS2+	1-2*	Demo circuit RCS2+ connection
		Open	Use external user-provided current-sense connection
JU16	ADCIN2	1-2*	Demo circuit ADCIN2 sense M2 VDRAIN / 4
		Open	Use external user-provided ADCIN2 connection
JU17	GATE2	1-2*	Demo circuit M2 gate connection
		Open	Connect to external user-provided FET gate
JU18	GATE1	1-2*	Demo circuit M1 gate connection
		Open	Connect to external user-provided FET gate
JU19	ADCIN1	1-2*	Demo circuit ADCIN1 sense M1 VDRAIN / 4
		Open	Use external user-provided ADCIN1 connection
JU20	RCS1-	1-2*	Demo circuit RCS1- connection
		Open	Use external user-provided current-sense connection
JU21	RCS1+	1-2*	Demo circuit RCS1+ connection
		Open	Use external user-provided current-sense connection

*Default configuration.

MAX1385 Evaluation Kit/Evaluation System

Troubleshooting

Unable to Communicate with MAX1385, No I²C Acknowledgment

The MAX1385 does not function until it receives two power-up commands at address 0x64 (shutdown register). Typical initialization command sequence is:

- 1) WriteWord(0x64, 0x0008)
- 2) WriteWord(0x64, 0x0008)

Unable to Communicate with HSI2CMOD and/or 68HC16MODULE-DIP Boards

Ensure that adequate power-supply voltage and current have been provided at the 68HC16MODULE-DIP module's J2 terminal block. The HSI2CMOD demands approximately 300mA of supply current at greater than 8V.

HSI2CMOD jumper JU1 should be in the 2-3 position. HSI2CMOD jumper JU5 should be unconnected (shunt on pin 1 only), until the software requests this jumper to be moved.

No Current Measurement

GATEVDD supply must be powered, and both CS1+ and CS2+ must be greater than 5V to enable the current measurement PGA to function. If using only one FET, disconnect the unused GATE_ output and connect the unused CS_+ to DVDD.

```
MAX1385 Write Reg 0x64 <— 0x0008
MAX1385 Write Reg 0x64 <— 0x0008
MAX1385 Write Reg 0x20 <— 0x02A8
MAX1385 Write Reg 0x22 <— 0x0EC0
MAX1385 Write Reg 0x24 <— 0x0161
MAX1385 Write Reg 0x26 <— 0x0083
MAX1385 Write Reg 0x28 <— 0x02A8
MAX1385 Write Reg 0x2A <— 0x0EC0
MAX1385 Write Reg 0x2C <— 0x0161
MAX1385 Write Reg 0x2E <— 0x0083
MAX1385 Write Reg 0x30 <— 0x0000
MAX1385 Write Reg 0x32 <— 0x0000
MAX1385 Write Reg 0x60 <— 0x0000
MAX1385 Write Reg 0x74 <— 0x00CC
MAX1385 Write Reg 0x76 <— 0x0066
MAX1385 Write Reg 0x7A <— 0x00CC
MAX1385 Write Reg 0x7C <— 0x0066
MAX1385 Write Reg 0x52 <— 0x0000
MAX1385 Write Reg 0x56 <— 0x0000
```

Listing 2. Basic Software Initialization Example

MAX1385 Evaluation Kit/Evaluation System

Evaluate: MAX1385/MAX1386

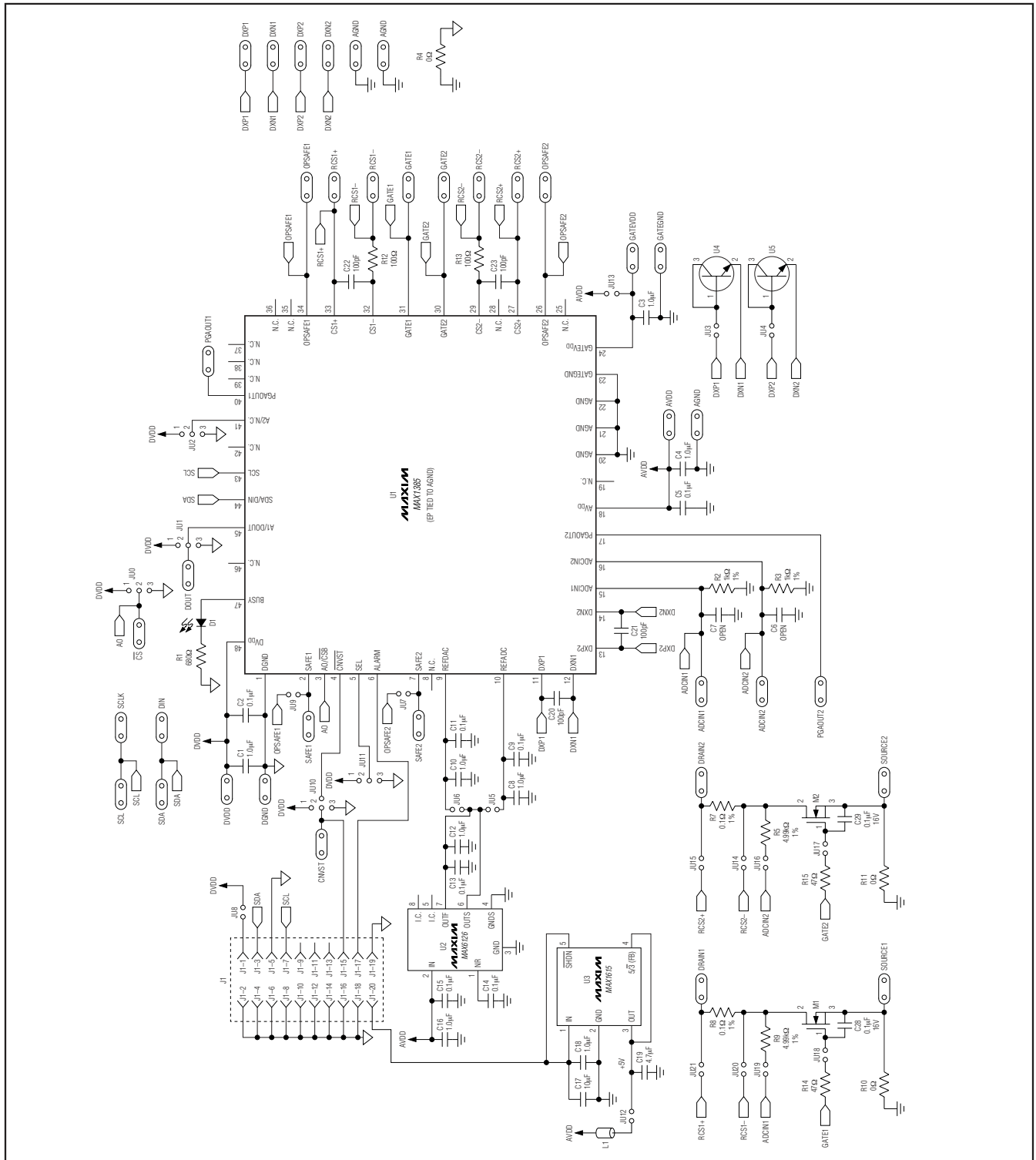

Figure 4. MAX1385 EV Kit Schematic

MAX1385 Evaluation Kit/Evaluation System

Evaluate: MAX1385/MAX1386

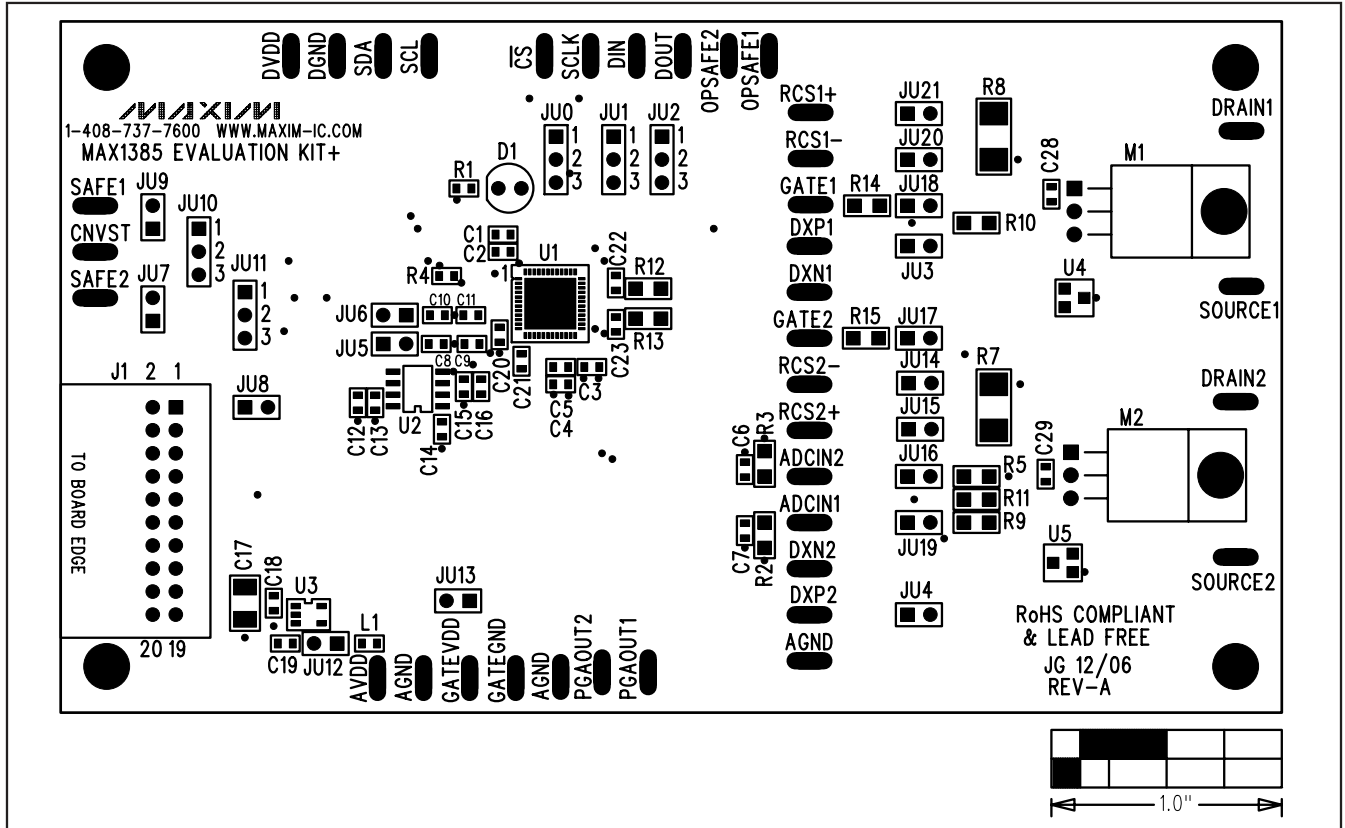

Figure 5. MAX1385 EV Kit Component Placement Guide—Component Side

MAX1385 Evaluation Kit/Evaluation System

Evaluate: MAX1385/MAX1386

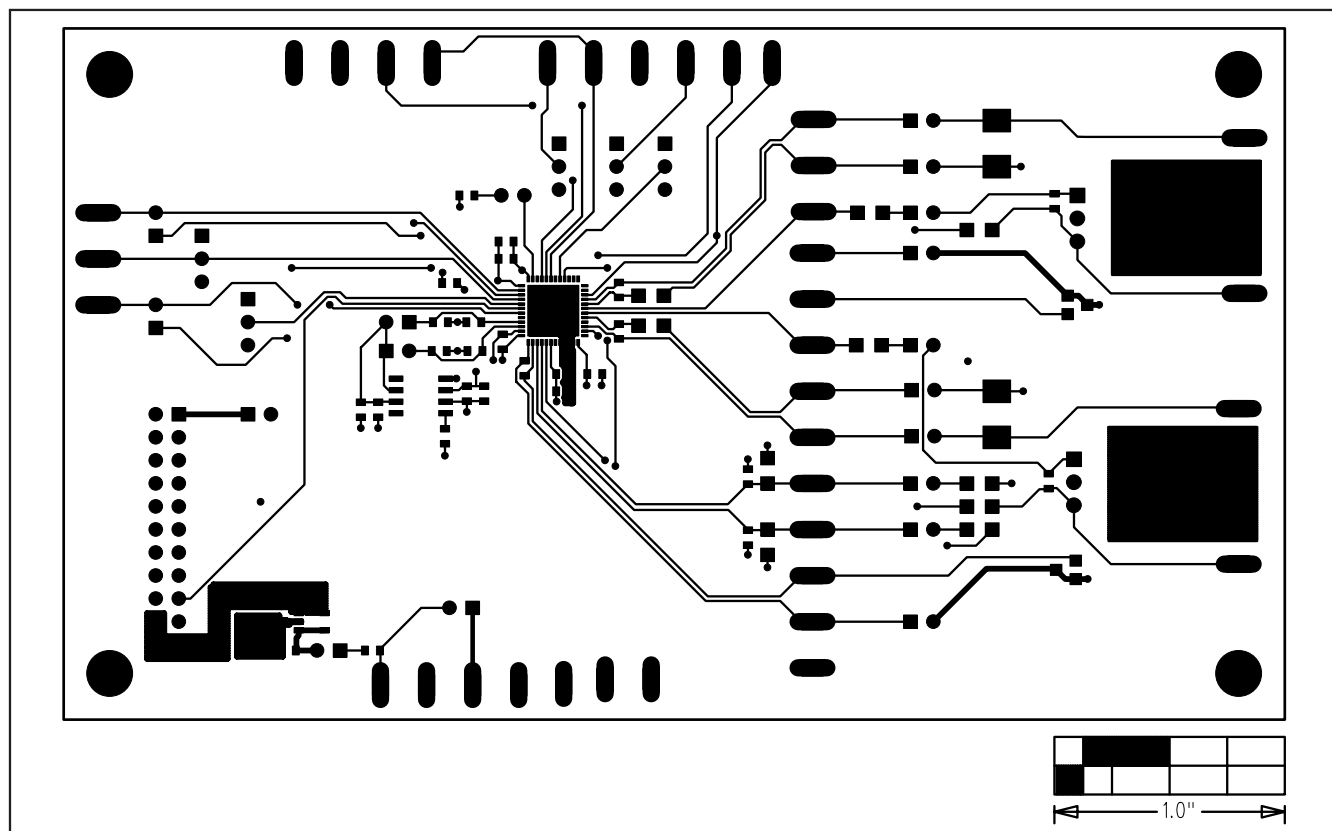

Figure 6. MAX1385 EV Kit PCB Layout—Component Side

MAX1385 Evaluation Kit/Evaluation System

Evaluate: MAX1385/MAX1386

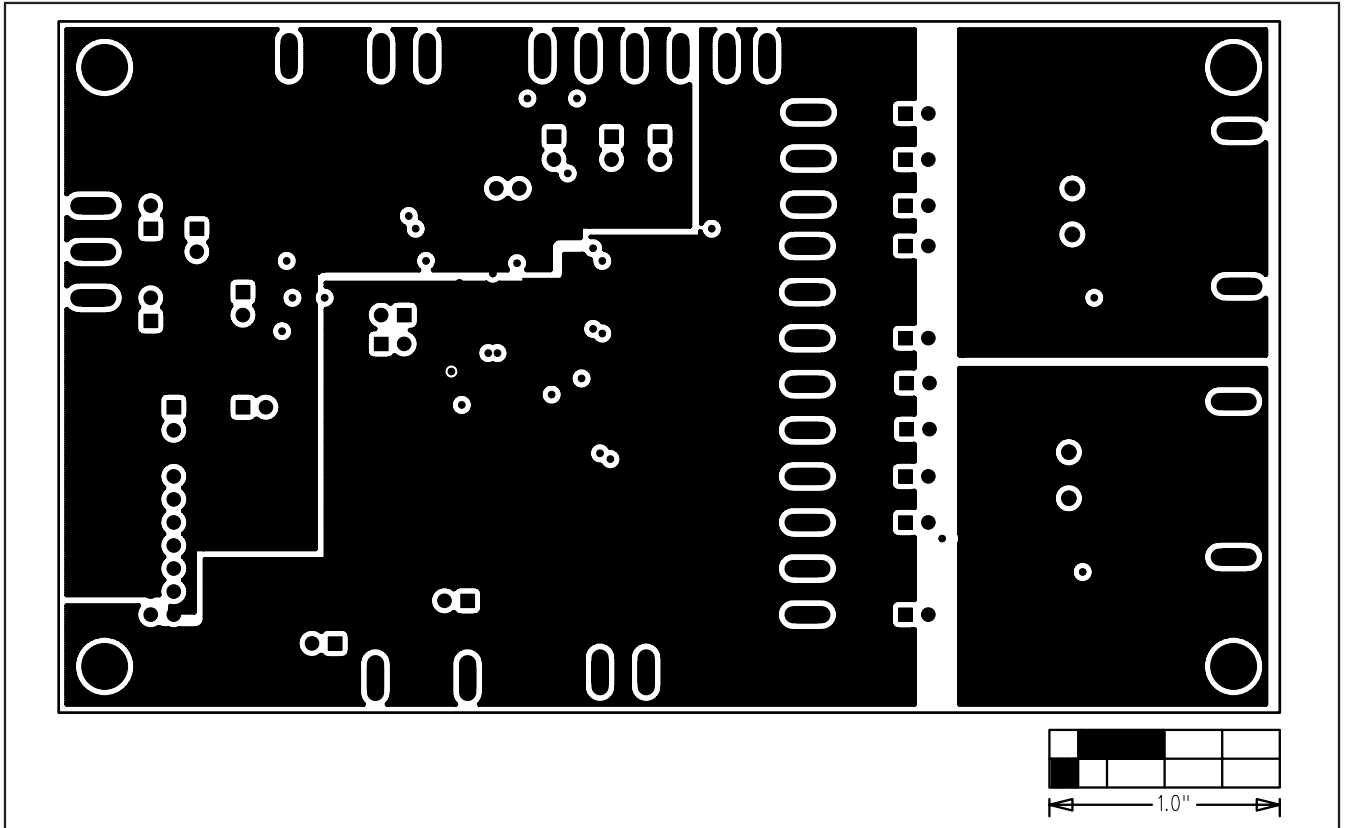

Figure 7. MAX1385 EV Kit PCB Layout—GND Layer 2

MAX1385 Evaluation Kit/Evaluation System

Evaluate: MAX1385/MAX1386

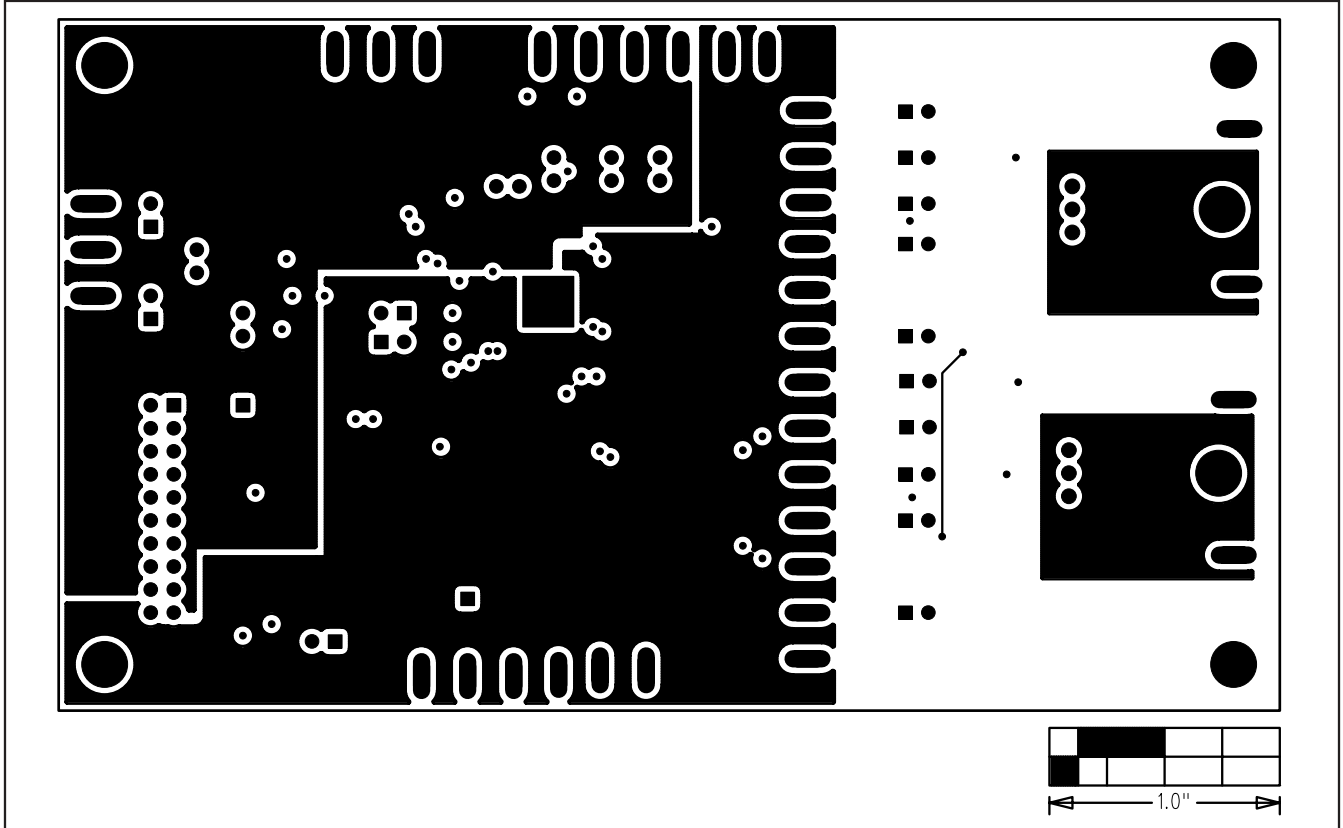

Figure 8. MAX1385 EV Kit PCB Layout—VCC Layer 3

MAX1385 Evaluation Kit/Evaluation System

Evaluate: MAX1385/MAX1386

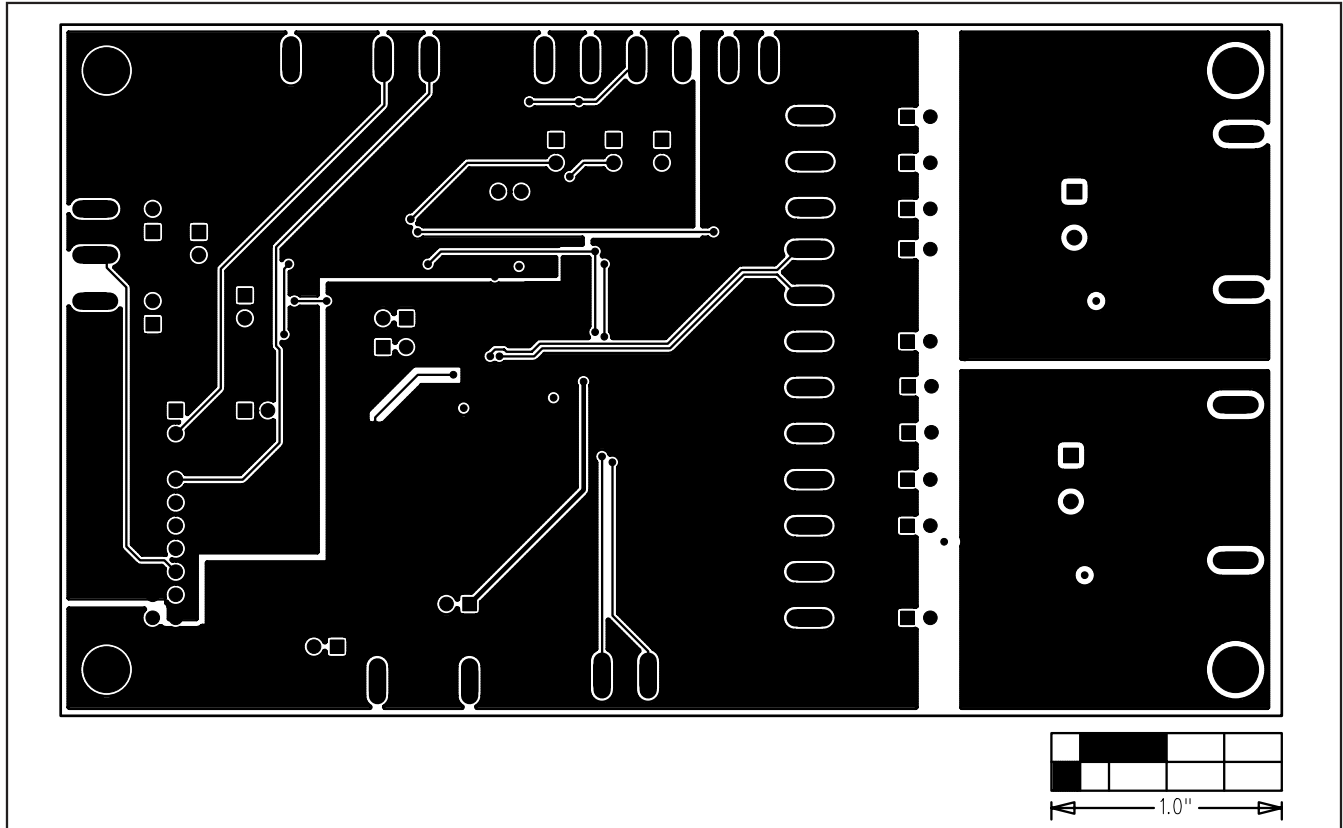

Figure 9. MAX1385 EV Kit PCB Layout—Solder Side

Maxim cannot assume responsibility for use of any circuitry other than circuitry entirely embodied in a Maxim product. No circuit patent licenses are implied. Maxim reserves the right to change the circuitry and specifications without notice at any time.

Maxim Integrated Products, 120 San Gabriel Drive, Sunnyvale, CA 94086 408-737-7600 _____ 15