

ELECTRICAL SPECIFICATION

PARAMETERS		VALUE	UNIT
Frequency Range		863 ~ 928	MHz
Returns Loss, max		-10	dB
VSWR, max		2	-
Gain		1.77	dBi
Impedance		50	Ω
Radiation Pattern		Omni-Directional	-
Polarization		Linear	-
Operating Temperature Range		-20 ~ +65	$^{\circ}\text{C}$
Cable	Coaxial	$\varnothing 1.13$	mm
	Color	Gray	-
Antenna Material		FPC	-
		0.5	oz
Connector		IPEX Compatible	-
Double Tape		3M467	-

DIMENSIONS

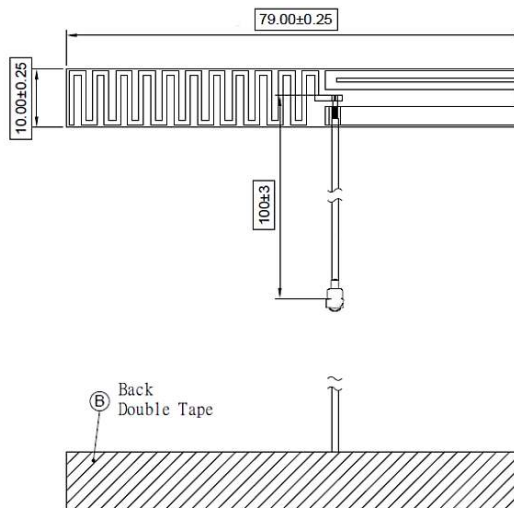
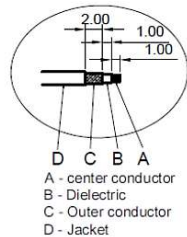

Unit : mm

■ FREQUENCY CHARACTERISTICS

Returns Loss

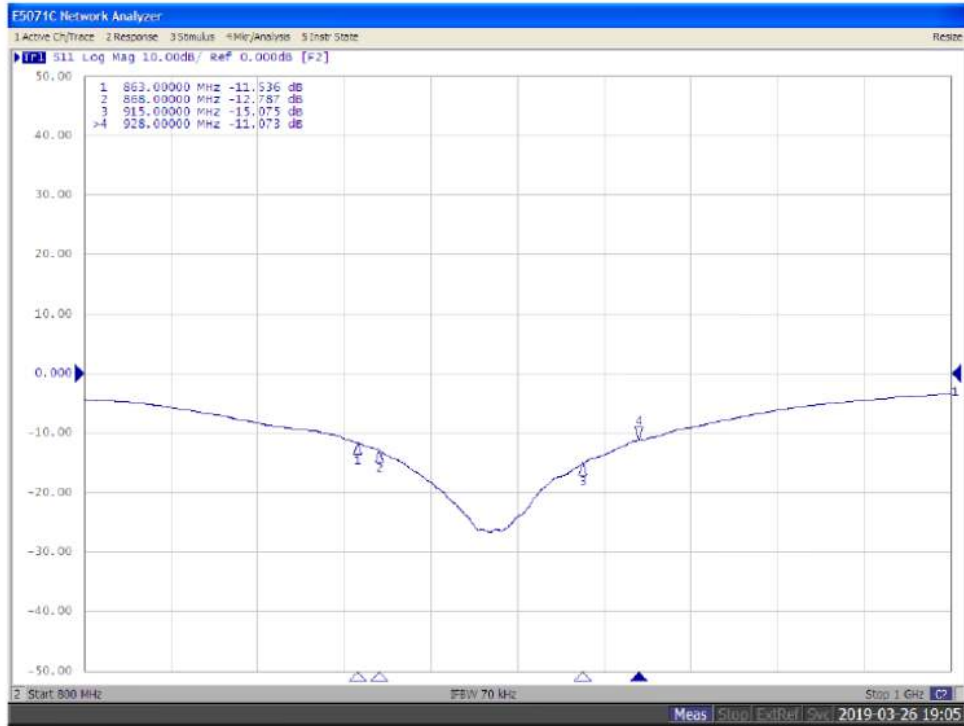

■ EFFICIENCY & PEAK GAIN

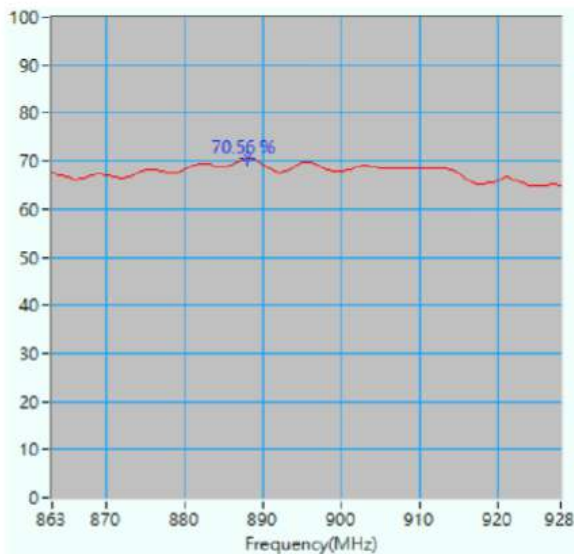

Maximum Efficiency at 888 MHz : 70.5 %

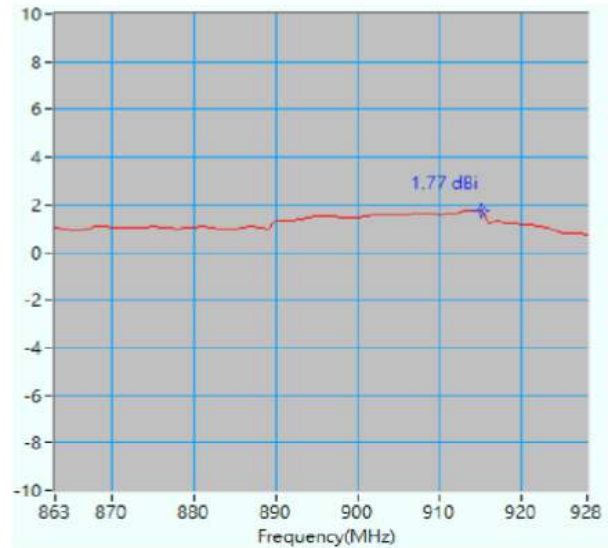

Maximum Peak Gain at 915 MHz : 1.77 dBi

■ RADIATION PATTERN

X-Z Plane
Phi=0.00deg

Gain . dB

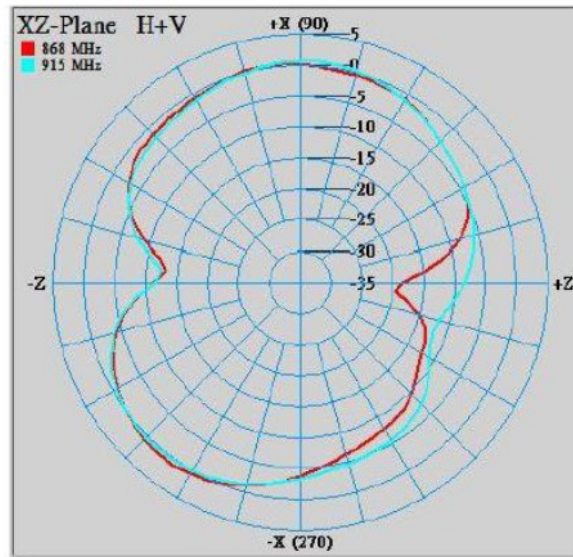

Y-Z Plane
Phi= 90.00deg

Gain . dB

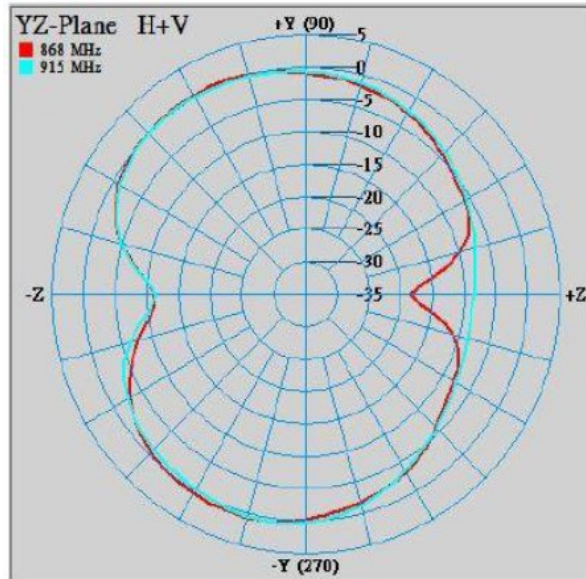

X-Y Plane
Theta= 90.00deg

Gain . dB

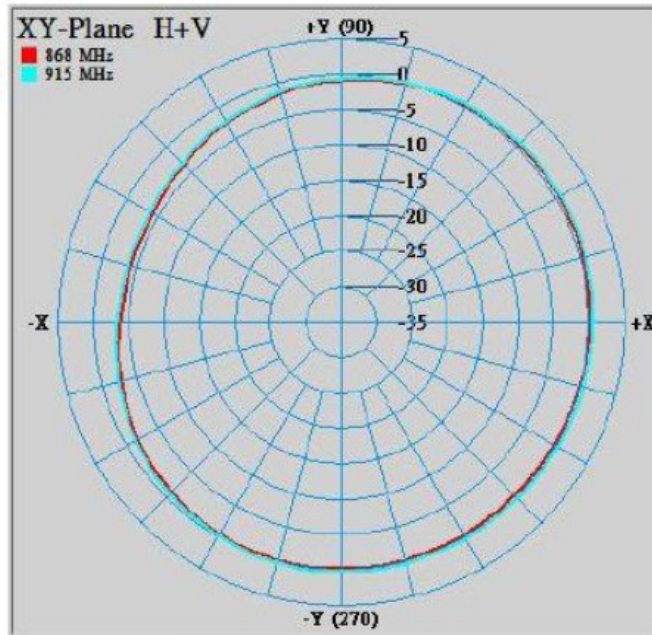

Frequency [MHz]	ZX plane		ZY plane		XY plane	
	Max Value [dB]	Average [dB]	Max Value [dB]	Average [dB]	Max Value [dB]	Average [dB]
868	0.87	-2.86	0.66	-2.50	0.52	-0.91
915	0.65	-2.72	0.48	-2.46	0.82	-0.54

■ APPROVAL

RALTRON	
DRAWN BY:	AR, April 04, 2019
APPROVED BY:	CP, April 04, 2019
REVISION:	A, Initial Release

Raltron Electronics / RAMI Technology USA, LLC, including its affiliates, employees, agents and other persons acting on its behalf (collectively Raltron/RAMI Tech), disclaim any and all liability for any errors or inaccuracies contained in this data sheet. While Raltron/RAMI Tech has made every reasonable effort ensure the accuracy of all product information, specifications and data contained herein, Raltron/RAMI Tech does not guarantee that the information is accurate, reliable or current. The product information is provided only for reference purposes only and is subject to change, correction or revision, at any time without notice. Raltron/RAMI Tech does not assume any liability arising out of an application or use of any product described herein and disclaims any warranties expressed or implied. The user of products in such applications shall assume all risks of such use and will agree to hold Raltron/RAMI Tech, harmless against all damages.

Copyright © 2016, Raltron Electronics / RAMI Technology USA, LLC. All rights reserved. No part of this document may be reproduced in any form without the prior written permission of Raltron Electronics / RAMI Technology USA, LLC.