

Features

- High static and dynamic commutation
- Three quadrants
- Logic level (direct microcontroller driven)
- Package is RoHS (2002/95/EC) compliant
- Tab insulated, voltage = 2500 V rms
- UL certified (ref. file E81734)

Applications

- General purpose AC line load switching
- Home appliances:
 - Fan
 - Pump
 - Solenoid
- Lighting
- Heaters
- Inrush current limiting circuits
- Overvoltage crowbar protection circuits

Description

Available in TO220AB-Insulated (ceramic insulated), the T1610T-8I series of Triac can be used in an on/off or phase angle control function in general purpose AC switching.

T1610T-8I can be directly driven through a microcontroller allowing usage of small capacitive or resistive power supplies.

Provides insulation rated at 2500 V rms (TO-220AB insulated package).

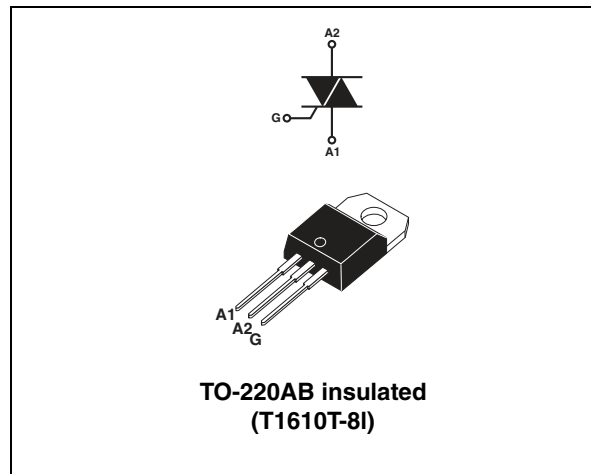

Table 1. Device summary

Order code	Quadrants	Value I_{GT} (mA)
T1610T-8I	I - II - III	10

1 Characteristics

Table 2. Absolute maximum rating ($T_j = 25\text{ }^\circ\text{C}$, unless otherwise specified)

Symbol	Parameter		Value	Unit	
$I_{T(RMS)}$	On-state rms current (full sine wave)		$T_c = 108\text{ }^\circ\text{C}$	16	A
			$T_c = 119\text{ }^\circ\text{C}$	12	
I_{TSM}	Non repetitive surge peak on-state current (full cycle, T_j initial = $25\text{ }^\circ\text{C}$)	$F = 50\text{ Hz}$	$t = 20\text{ ms}$	120	A
		$F = 60\text{ Hz}$	$t = 16.7\text{ ms}$	126	
I^2t	I^2t Value for fusing		$t_p = 10\text{ ms}$	95	A^2s
V_{DRM}, V_{RRM}	Repetitive peak off-state voltage, gate open		$T_j = 150\text{ }^\circ\text{C}$	600	V
			$T_j = 125\text{ }^\circ\text{C}$	800	
V_{DSM}, V_{RSM}	Non repetitive surge peak off-state voltage	$t_p = 10\text{ ms}$	$T_j = 25\text{ }^\circ\text{C}$	900	V
di/dt	Critical rate of rise of on-state current $I_G = 2 \times I_{GT}$		$F = 100\text{ Hz}$	100	$\text{A}/\mu\text{s}$
I_{GM}	Peak gate current		$t_p = 20\text{ }\mu\text{s}$	4	A
$P_{G(AV)}$	Average gate power dissipation			1	W
T_{stg}, T_j	Storage junction temperature range			-40 to +150	$^\circ\text{C}$
	Operating junction temperature range			-40 to +150	
T_L	Lead temperature for soldering during 10 s (at 4 mm from case for TO220AB-ins.)			260	$^\circ\text{C}$
$V_{ins}(\text{rms})$	Insulation rms voltage, 1 minute, TO220AB ceramic insulated			2500	V

Table 3. Electrical characteristics ($T_j = 25\text{ °C}$, unless otherwise specified)

Symbol	Test conditions		Quadrant		Value	Unit
$I_{GT}^{(1)}$	$V_D = 12\text{ V}$, $R_L = 30\ \Omega$		I - II - III	MIN.	0.5	mA
			I - II - III	MAX.	10	mA
V_{GT}	$V_D = 12\text{ V}$, $R_L = 30\ \Omega$		All	MAX.	1.3	V
V_{GD}	$V_D = 800\text{ V}$, $R_L = 3.3\text{ k}\Omega$, $T_j = 125\text{ °C}$		All	MIN.	0.2	V
$I_H^{(1)}$	$I_T = 500\text{ mA}$			MAX.	25	mA
I_L	$I_G = 1.2 I_{GT}$		I - III	MAX.	20	mA
			II		30	
$dV/dt^{(1)}$	$V_D = 67\% \times 800\text{ V}$ gate open	$T_j = 125\text{ °C}$		MIN.	100	V/ μ s
	$V_D = 67\% \times 600\text{ V}$ gate open	$T_j = 150\text{ °C}$			50	
$(dI/dt)_c^{(1)}$	$(dV/dt)_c = 0.1\text{ V}/\mu\text{s}$	$T_j = 125\text{ °C}$		MIN.	9	A/ms
	$(dV/dt)_c = 10\text{ V}/\mu\text{s}$	$T_j = 125\text{ °C}$			3	
	$(dV/dt)_c = 0.1\text{ V}/\mu\text{s}$	$T_j = 150\text{ °C}$			5.4	
	$(dV/dt)_c = 10\text{ V}/\mu\text{s}$	$T_j = 150\text{ °C}$			1.8	
t_{GT}	gate controlled turn on time $I_{TM} = 13\text{ A}$, $V_D = 400\text{ V}$, $I_G = 100\text{ mA}$, $dI_G/dt = 100\text{ mA}/\mu\text{s}$, $R_L = 30\ \Omega$		I - II - III	TYP.	2	μ s

1. For both polarities of A2 referenced to A1

Table 4. Static characteristics

Symbol	Test conditions			Value	Unit
$V_{TM}^{(1)}$	$I_{TM} = 22.6\text{ A}$, $t_p = 380\ \mu\text{s}$	$T_j = 25\text{ °C}$	MAX.	1.55	V
$V_{to}^{(1)}$	Threshold voltage	$T_j = 150\text{ °C}$	MAX.	0.85	V
$R_d^{(1)}$	Dynamic resistance	$T_j = 150\text{ °C}$	MAX.	30	$m\Omega$
I_{DRM} I_{RRM}	$V_{DRM} = V_{RRM} = 800\text{ V}$	$T_j = 25\text{ °C}$	MAX.	5	μ A
		$T_j = 125\text{ °C}$		1	mA
	$V_{DRM} = V_{RRM} = 600\text{ V}$	$T_j = 150\text{ °C}$		3.6	

1. for both polarities of A2 referenced to A1

Table 5. Thermal resistance

Symbol	Parameter	Value	Unit
$R_{th(j-c)}$	Junction to case (AC)	2.1	$^{\circ}\text{C}/\text{W}$
$R_{th(j-a)}$	Junction to ambient	60	$^{\circ}\text{C}/\text{W}$

Figure 1. Maximum power dissipation versus on-state rms current (full cycle)

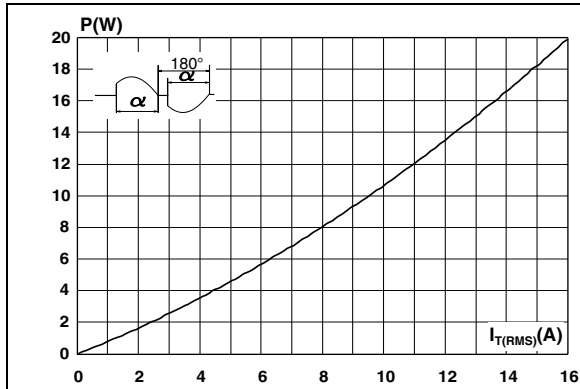

Figure 2. On-state rms current versus case temperature (full cycle)

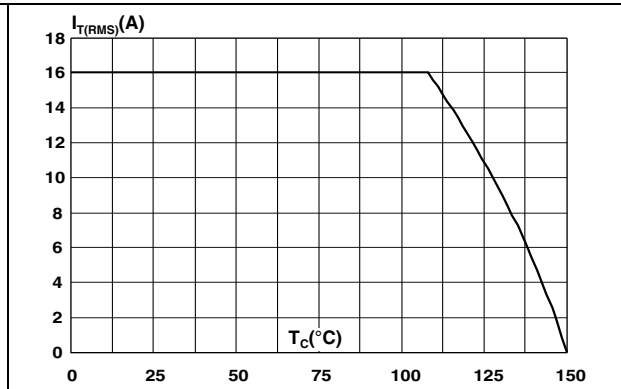

Figure 3. On-state rms current versus ambient temperature (free air convection)

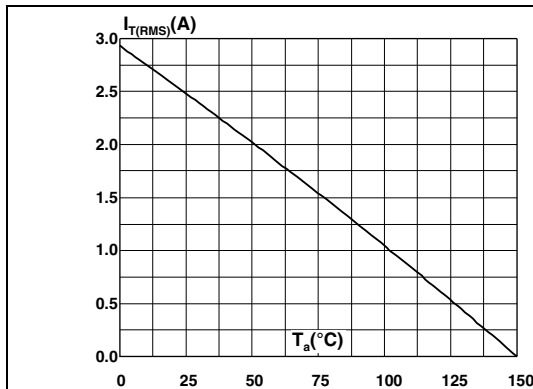

Figure 4. Relative variation of thermal impedance versus pulse duration

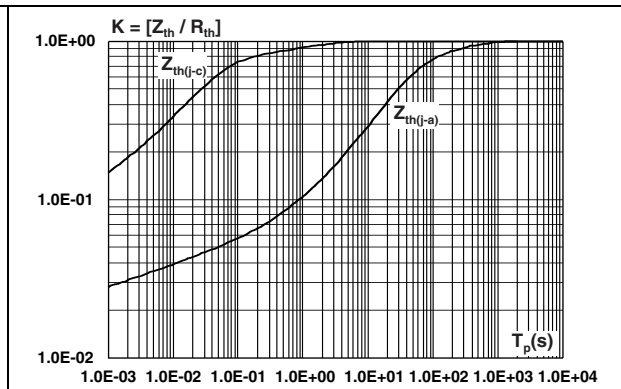

Figure 5. On-state characteristics (maximum values)

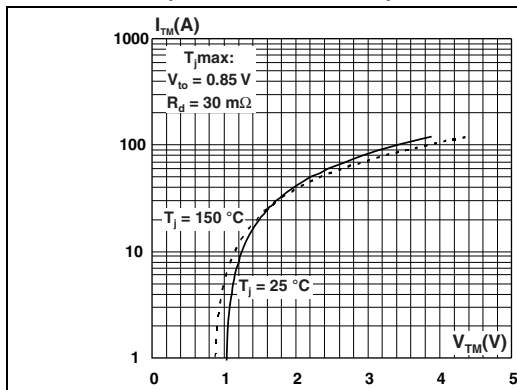

Figure 6. Surge peak on-state current versus number of cycles

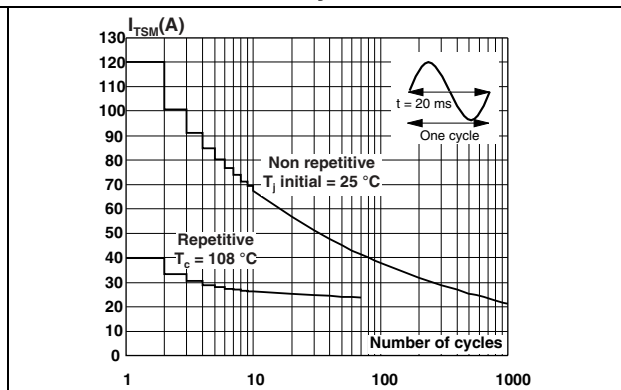

Figure 7. Non repetitive surge peak on-state current and corresponding values of I^2t

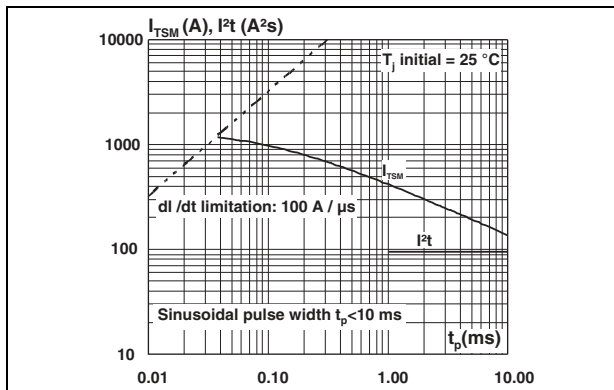

Figure 8. Relative variation of gate trigger current versus junction temperature (typical values)

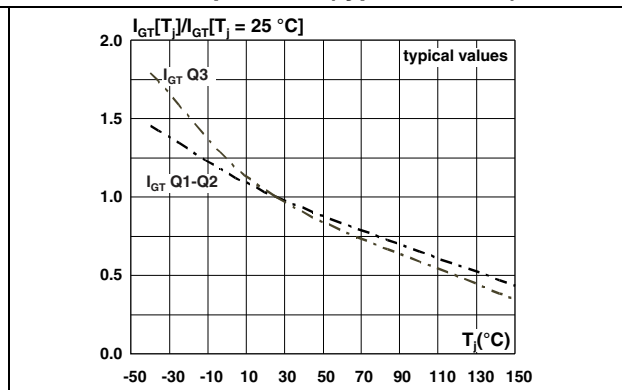

Figure 9. Relative variation of gate trigger voltage versus junction temperature (typical values)

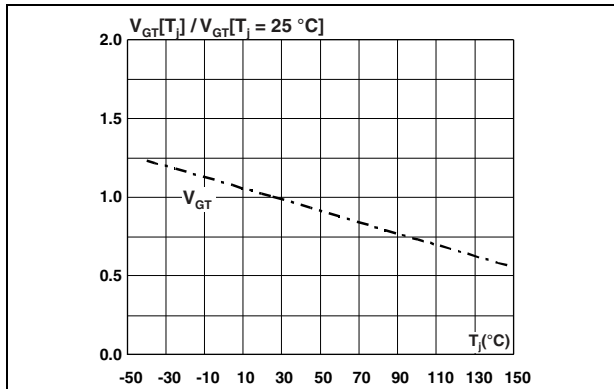

Figure 10. Relative variation of holding current and latching current versus junction temperature

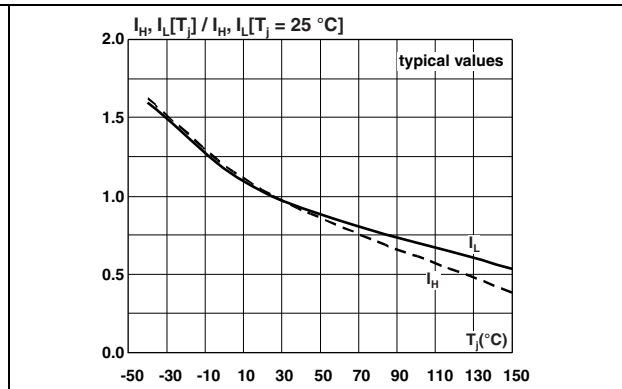

Figure 11. Relative variation of critical rate of decrease of current (di/dt)_c versus reapplied (dV/dt)_c

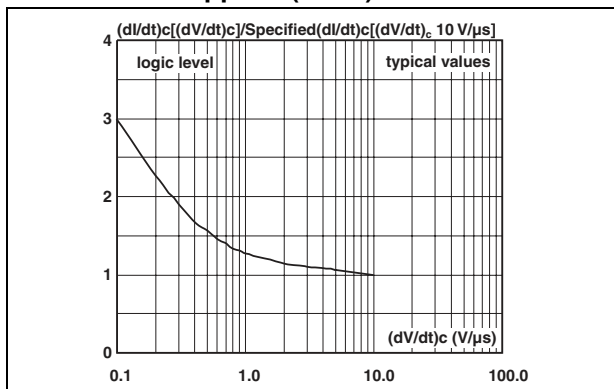

Figure 12. Relative variation of critical rate of decrease of current (di/dt)_c versus junction temperature

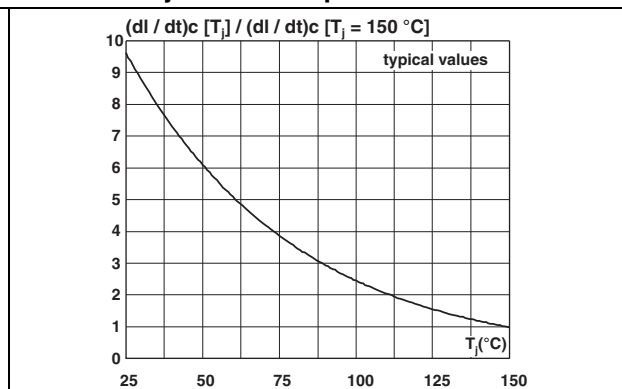

Figure 13. Relative variation of static dV/dt immunity versus junction temperature

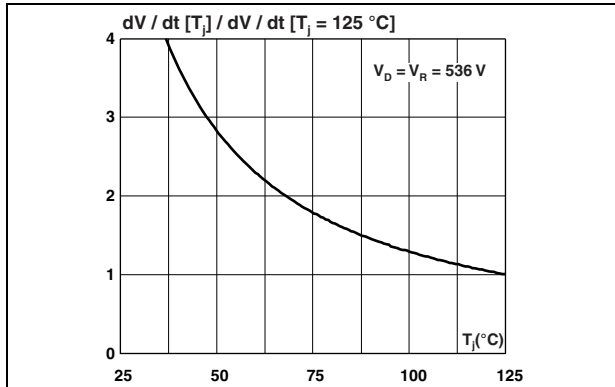

Figure 14. Relative variation of static dV/dt immunity versus junction temperature

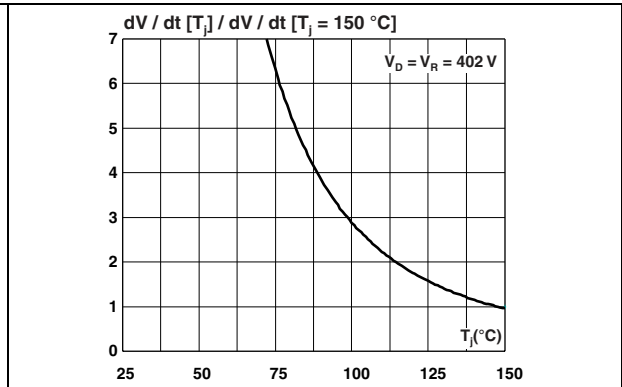
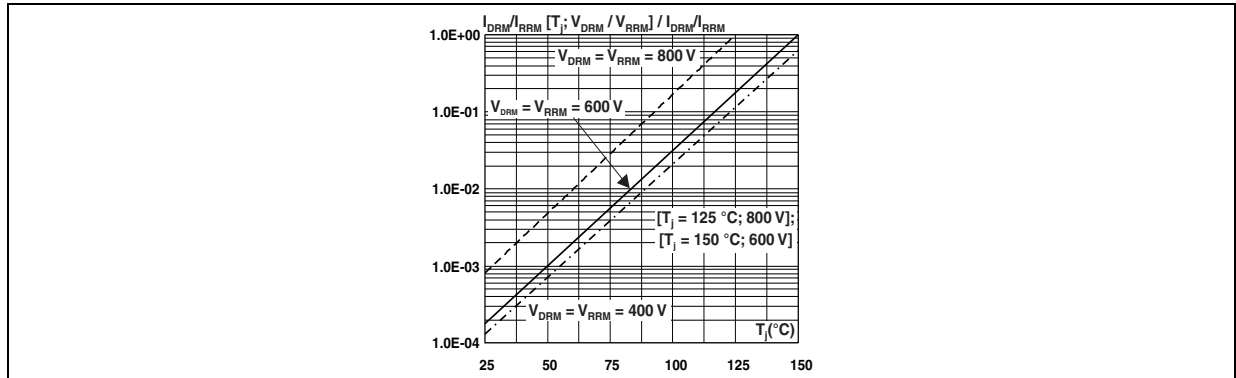

Figure 15. Relative variation of leakage current versus junction temperature for different values of blocking voltage



2 Package information

- Epoxy meets UL94, V0
- Recommended torque value: 0.4 to 0.6 N-m

In order to meet environmental requirements, ST offers these devices in different grades of ECOPACK® packages, depending on their level of environmental compliance. ECOPACK® specifications, grade definitions and product status are available at: www.st.com. ECOPACK® is an ST trademark.

Table 6. TO-220AB insulated dimensions

Ref.	Dimensions					
	Millimeters			Inches		
	Min.	Typ.	Max.	Min.	Typ.	Max.
A	15.20		15.90	0.598		0.625
a1		3.75			0.147	
a2	13.00		14.00	0.511		0.551
B	10.00		10.40	0.393		0.409
b1	0.61		0.88	0.024		0.034
b2	1.23		1.32	0.048		0.051
C	4.40		4.60	0.173		0.181
c1	0.49		0.70	0.019		0.027
c2	2.40		2.72	0.094		0.107
e	2.40		2.70	0.094		0.106
F	6.20		6.60	0.244		0.259
ØI	3.75		3.85	0.147		0.151
I4	15.80	16.40	16.80	0.622	0.646	0.661
L	2.65		2.95	0.104		0.116
I2	1.14		1.70	0.044		0.066
I3	1.14		1.70	0.044		0.066
M		2.60			0.102	

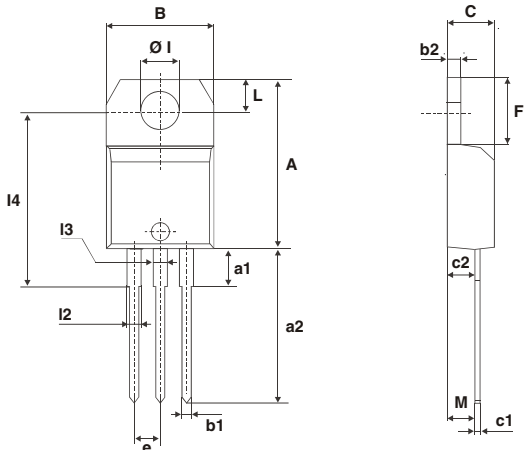

3 Ordering information scheme

Figure 16. Ordering information scheme

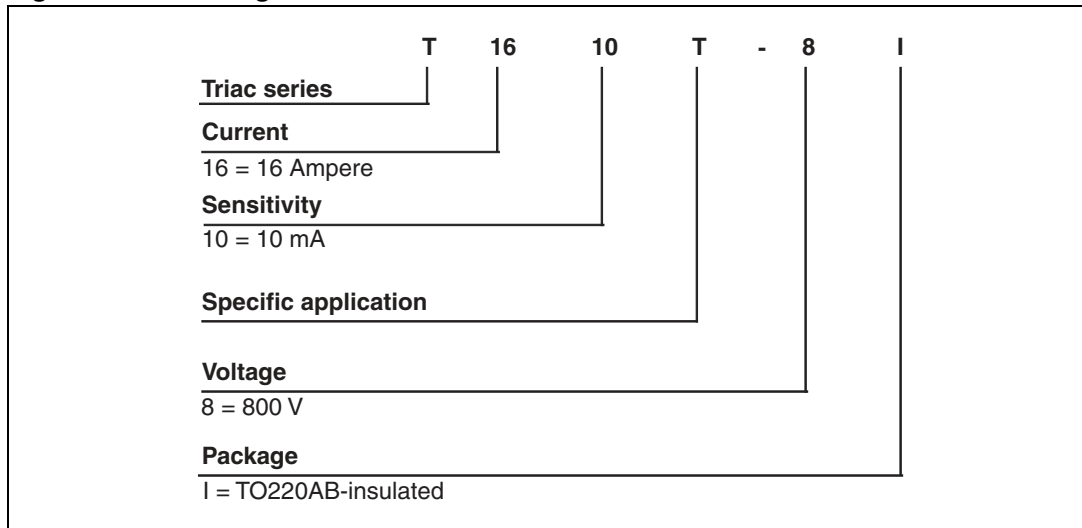

4 Ordering information

Table 7. Ordering information

Order code	Marking	Package	Weight	Base qty	Delivery mode
T1610T-8I	T1610T-8I	TO-220AB insulated	2.3	50	Tube

5 Revision history

Table 8. Document revision history

Date	Revision	Changes
08-Aug-2011	1	First issue.
20-Jan-2012	2	Corrected subscripting error in Table 3 .
25-Apr-2012	3	Updated UL certification.

Please Read Carefully:

Information in this document is provided solely in connection with ST products. STMicroelectronics NV and its subsidiaries ("ST") reserve the right to make changes, corrections, modifications or improvements, to this document, and the products and services described herein at any time, without notice.

All ST products are sold pursuant to ST's terms and conditions of sale.

Purchasers are solely responsible for the choice, selection and use of the ST products and services described herein, and ST assumes no liability whatsoever relating to the choice, selection or use of the ST products and services described herein.

No license, express or implied, by estoppel or otherwise, to any intellectual property rights is granted under this document. If any part of this document refers to any third party products or services it shall not be deemed a license grant by ST for the use of such third party products or services, or any intellectual property contained therein or considered as a warranty covering the use in any manner whatsoever of such third party products or services or any intellectual property contained therein.

UNLESS OTHERWISE SET FORTH IN ST'S TERMS AND CONDITIONS OF SALE ST DISCLAIMS ANY EXPRESS OR IMPLIED WARRANTY WITH RESPECT TO THE USE AND/OR SALE OF ST PRODUCTS INCLUDING WITHOUT LIMITATION IMPLIED WARRANTIES OF MERCHANTABILITY, FITNESS FOR A PARTICULAR PURPOSE (AND THEIR EQUIVALENTS UNDER THE LAWS OF ANY JURISDICTION), OR INFRINGEMENT OF ANY PATENT, COPYRIGHT OR OTHER INTELLECTUAL PROPERTY RIGHT.

UNLESS EXPRESSLY APPROVED IN WRITING BY TWO AUTHORIZED ST REPRESENTATIVES, ST PRODUCTS ARE NOT RECOMMENDED, AUTHORIZED OR WARRANTED FOR USE IN MILITARY, AIR CRAFT, SPACE, LIFE SAVING, OR LIFE SUSTAINING APPLICATIONS, NOR IN PRODUCTS OR SYSTEMS WHERE FAILURE OR MALFUNCTION MAY RESULT IN PERSONAL INJURY, DEATH, OR SEVERE PROPERTY OR ENVIRONMENTAL DAMAGE. ST PRODUCTS WHICH ARE NOT SPECIFIED AS "AUTOMOTIVE GRADE" MAY ONLY BE USED IN AUTOMOTIVE APPLICATIONS AT USER'S OWN RISK.

Resale of ST products with provisions different from the statements and/or technical features set forth in this document shall immediately void any warranty granted by ST for the ST product or service described herein and shall not create or extend in any manner whatsoever, any liability of ST.

ST and the ST logo are trademarks or registered trademarks of ST in various countries.

Information in this document supersedes and replaces all information previously supplied.

The ST logo is a registered trademark of STMicroelectronics. All other names are the property of their respective owners.

© 2012 STMicroelectronics - All rights reserved

STMicroelectronics group of companies

Australia - Belgium - Brazil - Canada - China - Czech Republic - Finland - France - Germany - Hong Kong - India - Israel - Italy - Japan - Malaysia - Malta - Morocco - Philippines - Singapore - Spain - Sweden - Switzerland - United Kingdom - United States of America

www.st.com