

### ■回路図 CIRCUIT

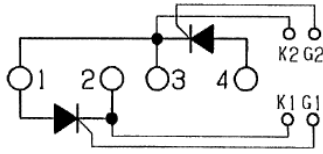

### ■外形寸法図 OUTLINE DRAWING

Dimension: [mm]

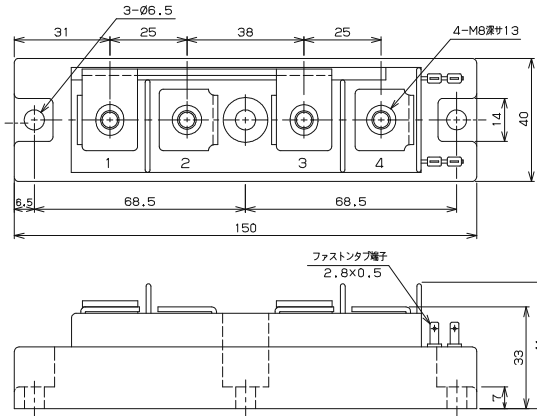

### ■最大定格 Maximum Ratings

項目 Parameter	記号 Symbol	耐圧クラス Grade	単位 Unit
		PDT25016	
くり返しピークオフ電圧 Repetitive Peak Off-State Voltage	$V_{DRM}$	1600	V
非くり返しピークオフ電圧 Non Repetitive Peak Off-State Voltage	$V_{DSM}$	1700	V
くり返しピーク逆電圧 Repetitive Peak Reverse Voltage	$V_{RRM}$	1600	V
非くり返しピーク逆電圧 Non Repetitive Peak Reverse Voltage	$V_{RSM}$	1700	V

項目 Parameter	記号 Symbol	条件 Conditions	定格値 Max. Rated Value	単位 Unit	
平均整流電流 Average Rectified Output Current	$I_{O(AV)}$	商用周波数 180° 通電 Half Sine Wave	250	A	
実効オン電流 RMS On-State Current	$I_{TRMS}$		390	A	
サージオン電流 Surge On-State Current	$I_{TSM}$	50Hz 正弦半波, 1サージ, 非くり返し Half Sine Wave, 1Pulse, Non-Repetitive	4000	A	
電流二乗時間積 $I^2t$		2~10ms	80000	A <sup>2</sup> s	
臨界オン電流上昇率 Critical Rate of Rise of Turned-On Current	di/dt	$V_D = 2/3 V_{DRM}$ , $I_{TM} = 2 \cdot I_O$ , $T_J = 125^\circ C$ $I_G = 300mA$ , $di_G/dt = 0.2A/\mu s$	100	A/ $\mu s$	
ピークゲート電力損失 Peak Gate Power	$P_{GM}$		5	W	
平均ゲート電力損失 Average Gate Power	$P_{G(AV)}$		1	W	
ピークゲート電流 Peak Gate Current	$I_{GM}$		2	A	
ピークゲート電圧 Peak Gate Voltage	$V_{GM}$		10	V	
ピークゲート逆電圧 Peak Gate Reverse Voltage	$V_{RGM}$		5	V	
動作接合温度範囲 Operating Junction Temperature Range	$T_{jw}$		-40 ~ +125	°C	
保存温度範囲 Storage Temperature Range	$T_{stg}$		-40 ~ +125	°C	
絶縁耐圧 Isolation Voltage	$V_{iso}$	端子-ベース間, AC 1分間 Terminal to Base, AC 1min.	2500	V	
締付トルク Mounting Torque	ベース部 Mounting	F サマロソパ ウンド 塗布 Greased	M6	2.5 ~ 3.5	N·m
	主端子部 Terminal		M8	9.0 ~ 10.0	N·m

■電気的特性 Electrical Characteristics

項目 Parameter	記号 Symbol	条件 Conditions	特性値 (最大) Maximum Value			単位 Unit
			最小 Min	標準 Typ	最大 Max	
ピークオフ電流 Peak Off-State Current	$I_{DM}$	$T_j = 125^\circ\text{C}$ , $V_{DM} = V_{DRM}$			80	mA
ピーク逆電流 Peak Reverse Current	$I_{RM}$	$T_j = 125^\circ\text{C}$ , $V_{RM} = V_{RRM}$			80	mA
ピークオン電圧 Peak Off-State Voltage	$V_{TM}$	$T_j = 25^\circ\text{C}$ , $I_{TM} = 800\text{A}$			1.38	V
トリガゲート電流 Gate Current to Trigger	$I_{GT}$	$V_D = 6\text{V}$ , $I_T = 1\text{A}$	$T_j = -40^\circ\text{C}$		300	mA
			$T_j = 25^\circ\text{C}$		150	
			$T_j = 125^\circ\text{C}$		80	
トリガゲート電圧 Gate Voltage to Trigger	$V_{GT}$	$V_D = 6\text{V}$ , $I_T = 1\text{A}$	$T_j = -40^\circ\text{C}$		5	V
			$T_j = 25^\circ\text{C}$		3	
			$T_j = 125^\circ\text{C}$		2	
非トリガゲート電圧 Gate Non-Trigger Voltage	$V_{GD}$	$T_j = 125^\circ\text{C}$ , $V_D = 2/3 V_{DRM}$	0.25			V
臨界オフ電圧上昇率 Critical Rate of Rise of Off-State Voltage	$dv/dt$	$T_j = 125^\circ\text{C}$ , $V_D = 2/3 V_{DRM}$	500			V/ $\mu\text{s}$
ターンオフ時間 Turn-Off Time	$t_q$	$T_j = 125^\circ\text{C}$ , $I_{TM} = I_o$ , $V_D = 2/3 V_{DRM}$ $dv/dt = 20\text{V}/\mu\text{s}$ , $V_R = 100\text{V}$ , $-di/dt = 20\text{A}/\mu\text{s}$		200		$\mu\text{s}$
ターンオン時間 Turn-On Time	$t_{gt}$	$T_j = 25^\circ\text{C}$ , $V_D = 2/3 V_{DRM}$ $I_G = 300\text{mA}$ , $di_G/dt = 0.2\text{A}/\mu\text{s}$		6		$\mu\text{s}$
遅れ時間 Delay Time	$t_d$			2		$\mu\text{s}$
立ち上がり時間 Rise Time	$t_r$			4		$\mu\text{s}$
ラッチング電流 Latching Current	$I_L$	$T_j = 25^\circ\text{C}$		150		mA
保持電流 Holding Current	$I_H$	$T_j = 25^\circ\text{C}$		100		mA
熱抵抗 Thermal Resistance	$R_{th(j-c)}$	接合部-ケース間 Junction to Case			0.18	$^\circ\text{C}/\text{W}$
接触熱抵抗 Thermal Resistance	$R_{th(c-f)}$	ケースフィン間, サーマルコンパウンド塗布 Case to Fin, Greased			0.1	$^\circ\text{C}/\text{W}$

質量 --- 約480 g  
Approximate Weight

1アーム当りの値 Value Per 1 Arm.

オン電圧特性  
ON-STATE CURRENT VS. VOLTAGE

PDT25016 (Per 1 Arm.)

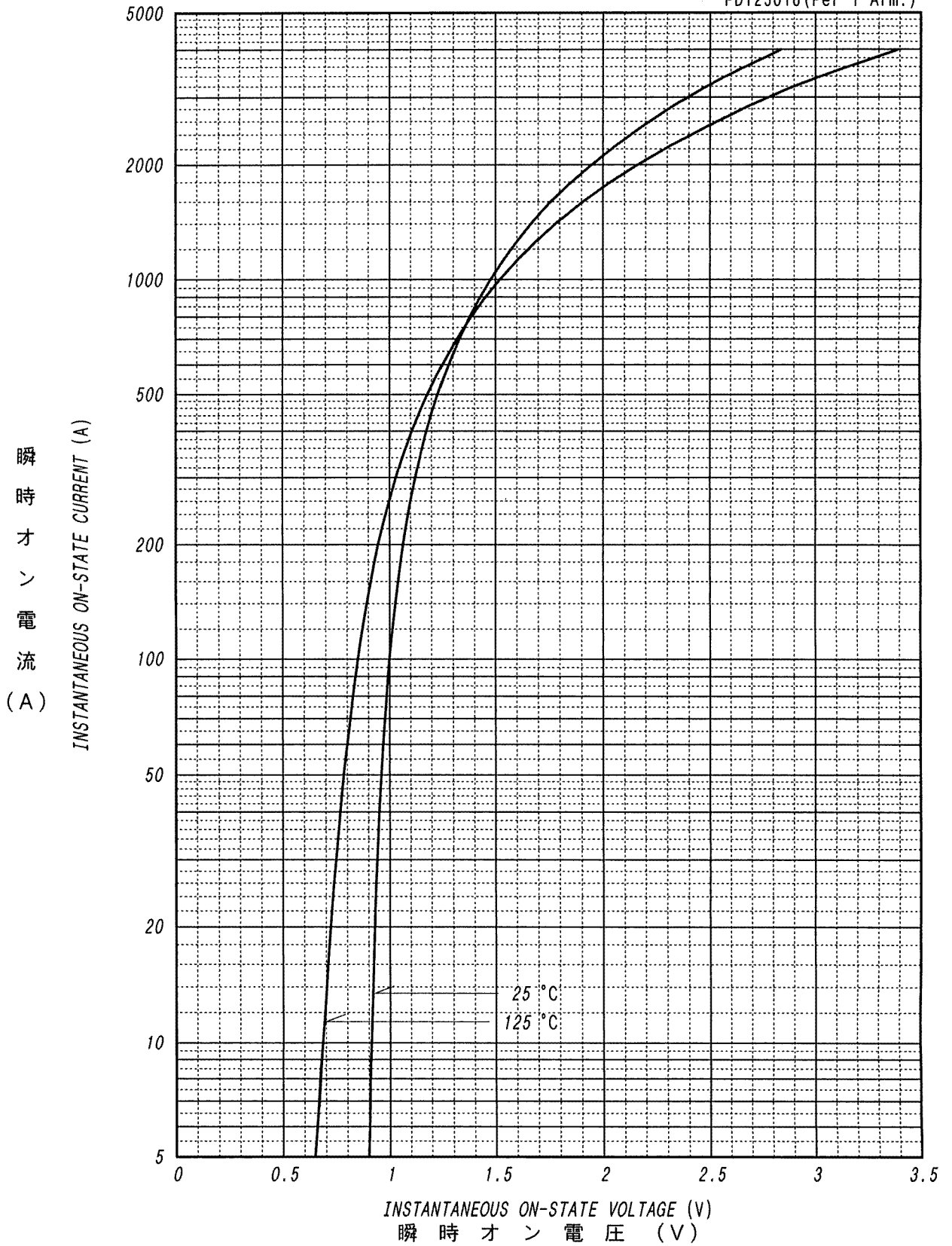

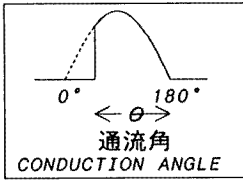

平均オン電力損失特性  
 AVERAGE ON-STATE POWER DISSIPATION

for SINUSOIDAL CURRENT WAVEFORM

PDT25016 (Per 1 Arm.)

平均オン電力損失 (W)  
 AVERAGE ON-STATE POWER DISSIPATION (W)

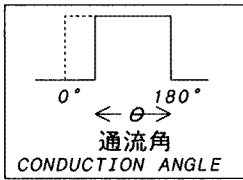
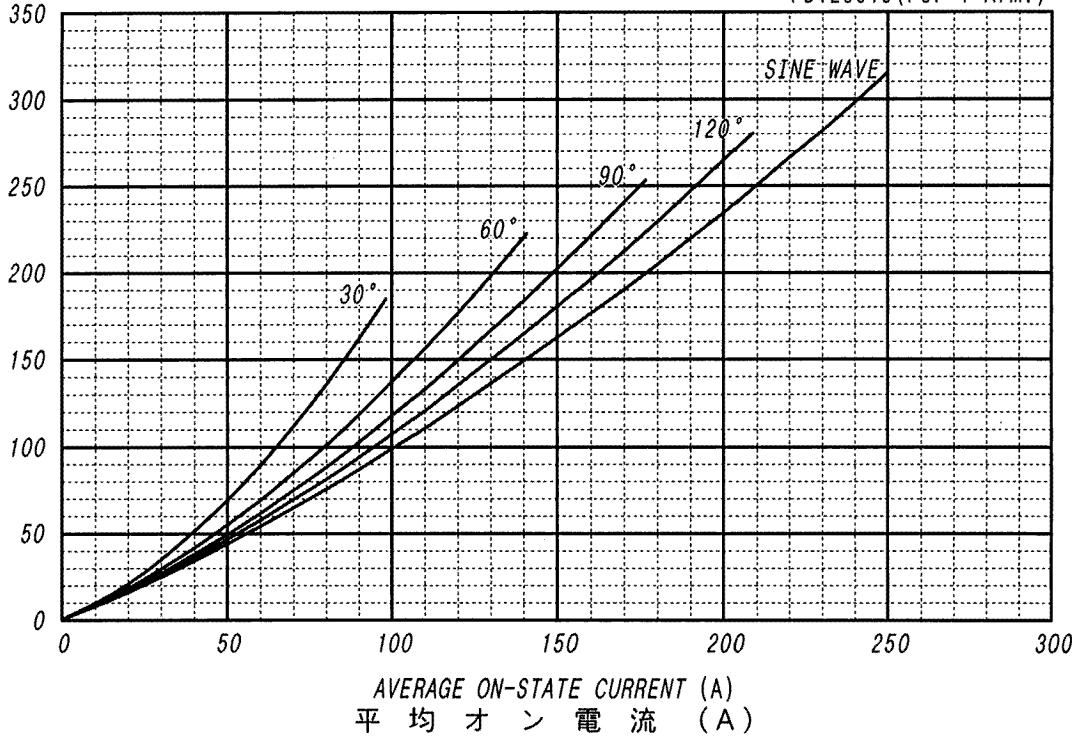

平均オン電力損失特性  
 AVERAGE ON-STATE POWER DISSIPATION

for RECTANGULAR CURRENT WAVEFORM

PDT25016 (Per 1 Arm.)

平均オン電力損失 (W)  
 AVERAGE ON-STATE POWER DISSIPATION (W)

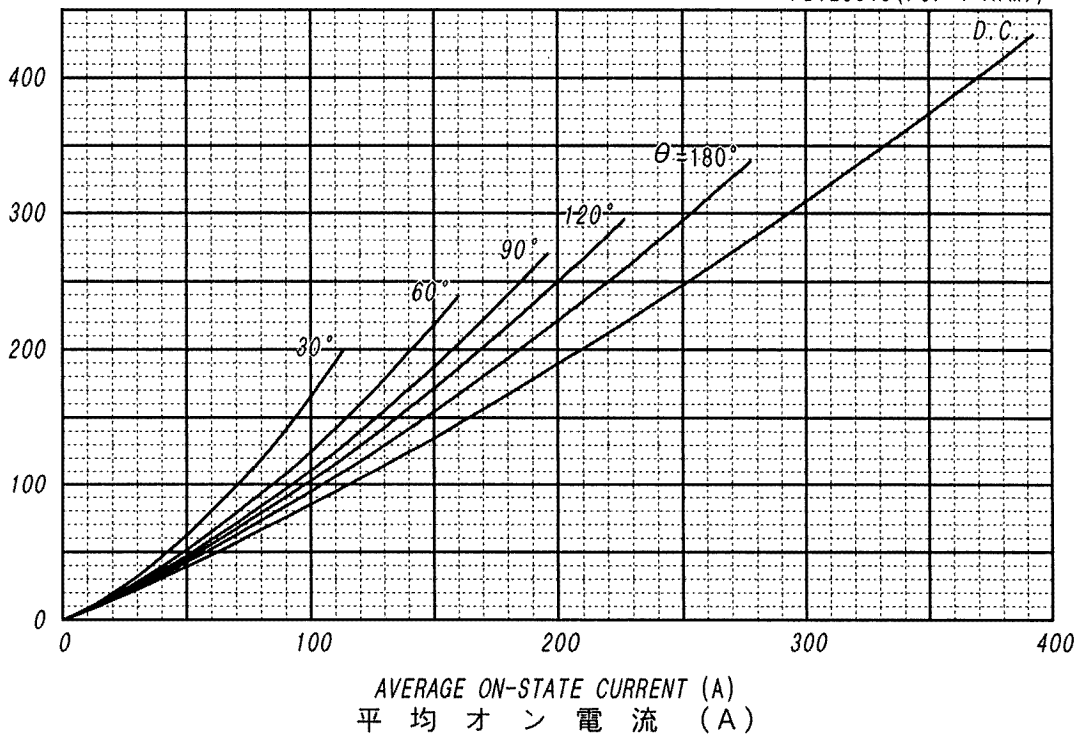

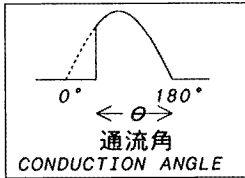

平均オン電流 - ケース温度定格  
 AVERAGE ON-STATE CURRENT VS. CASE TEMPERATURE

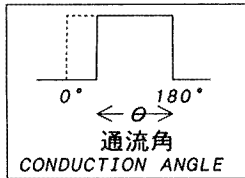
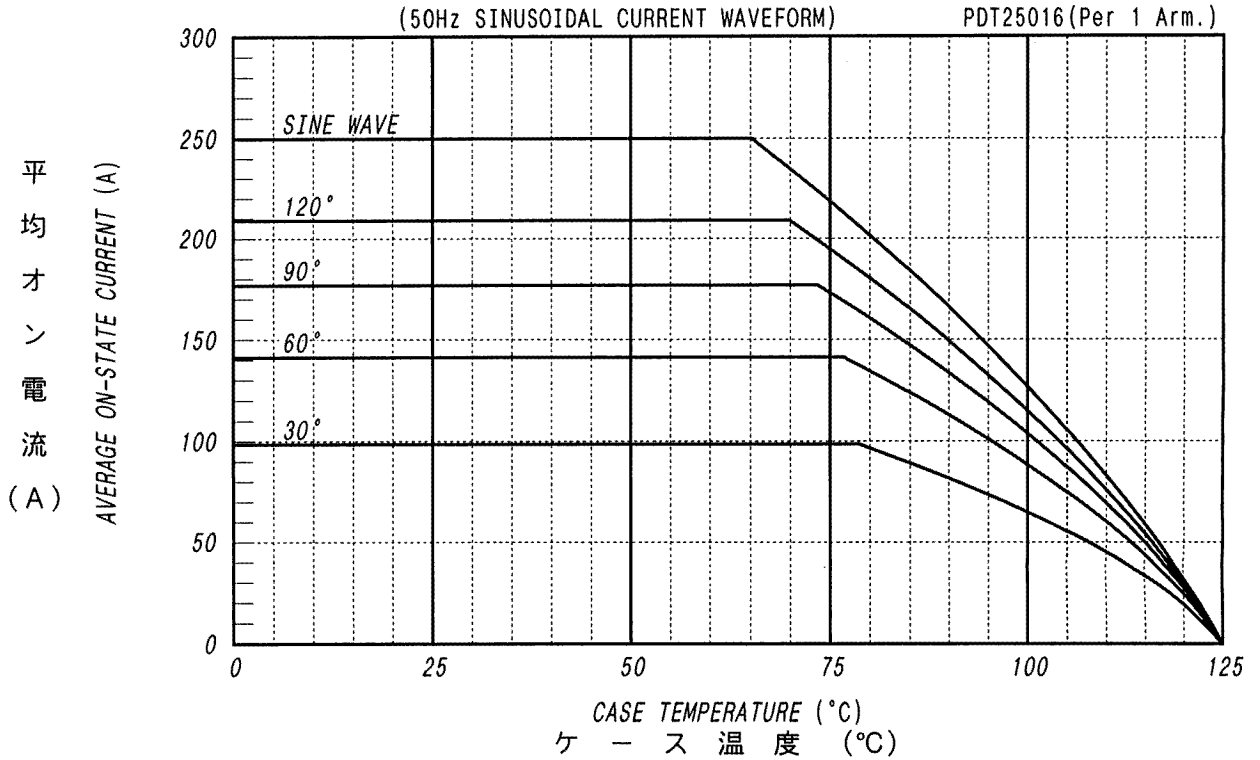

平均オン電流 - ケース温度定格  
 AVERAGE ON-STATE CURRENT VS. CASE TEMPERATURE

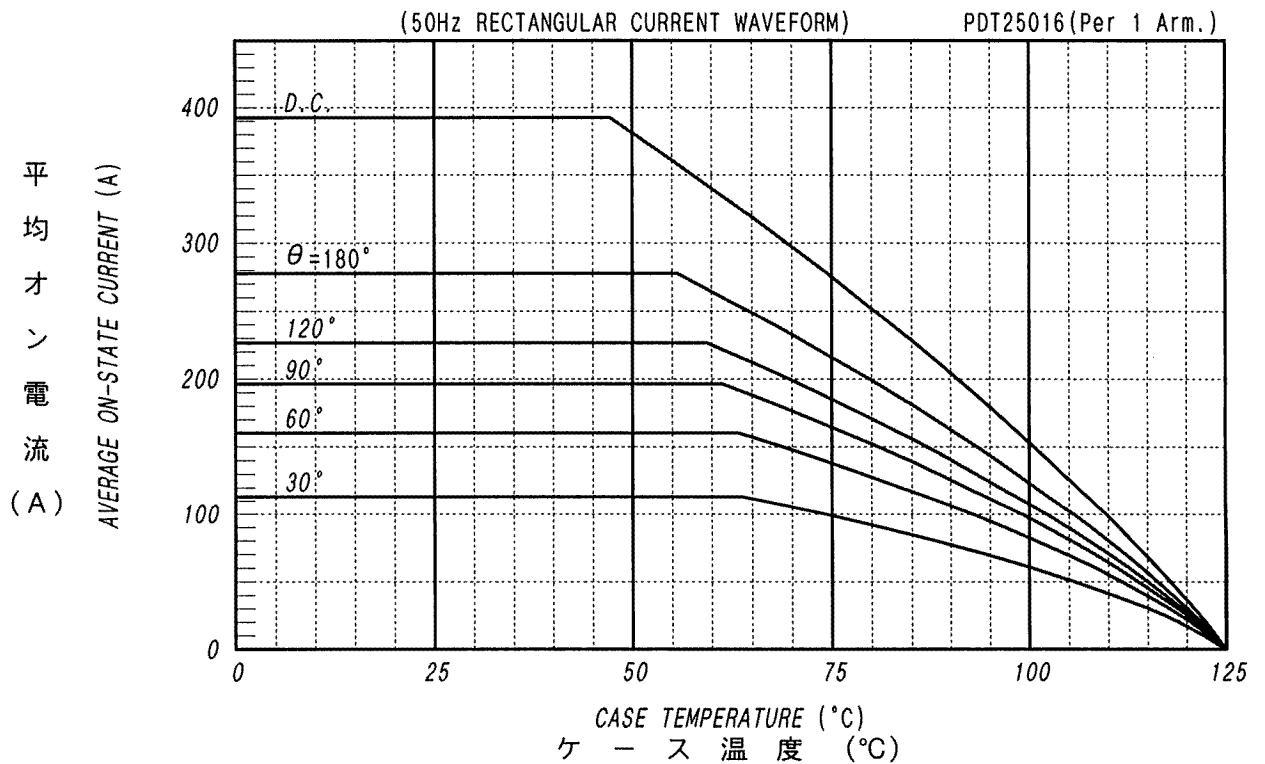

ゲート特性  
GATE CHARACTERISTICS

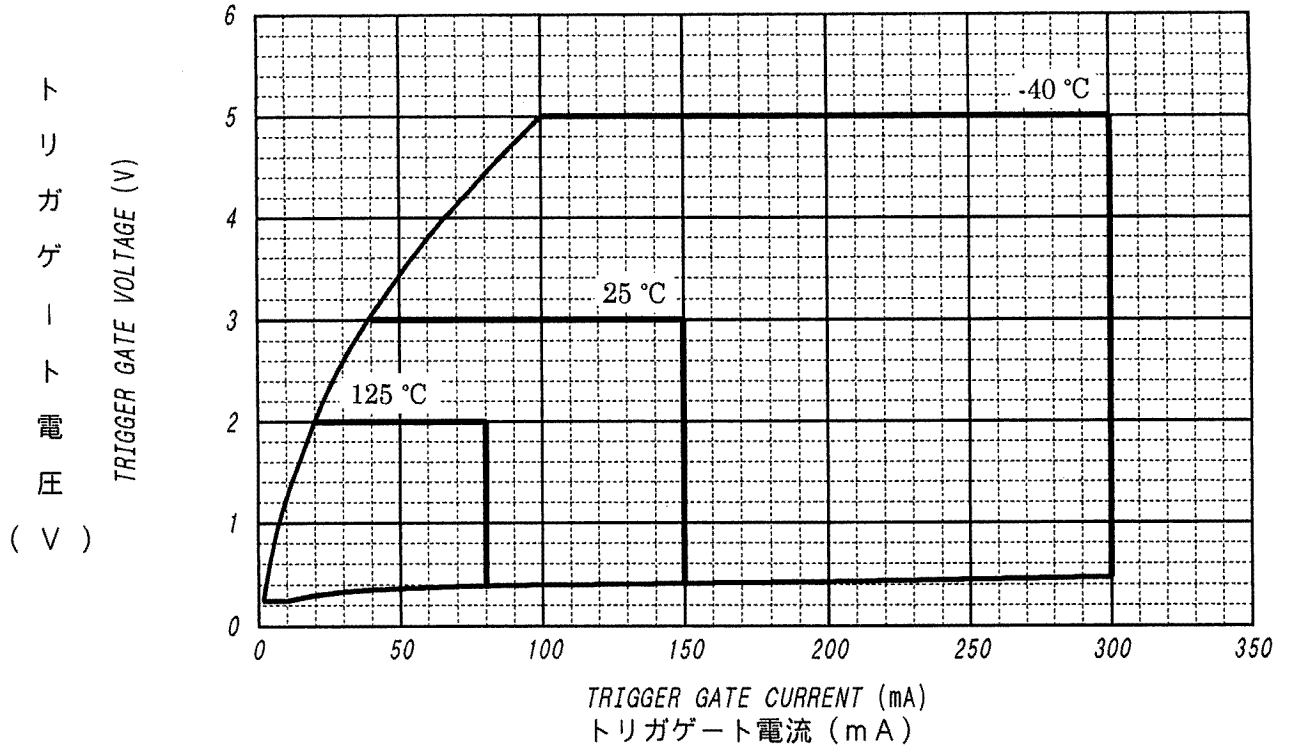

ゲート定格  
GATE RATINGS

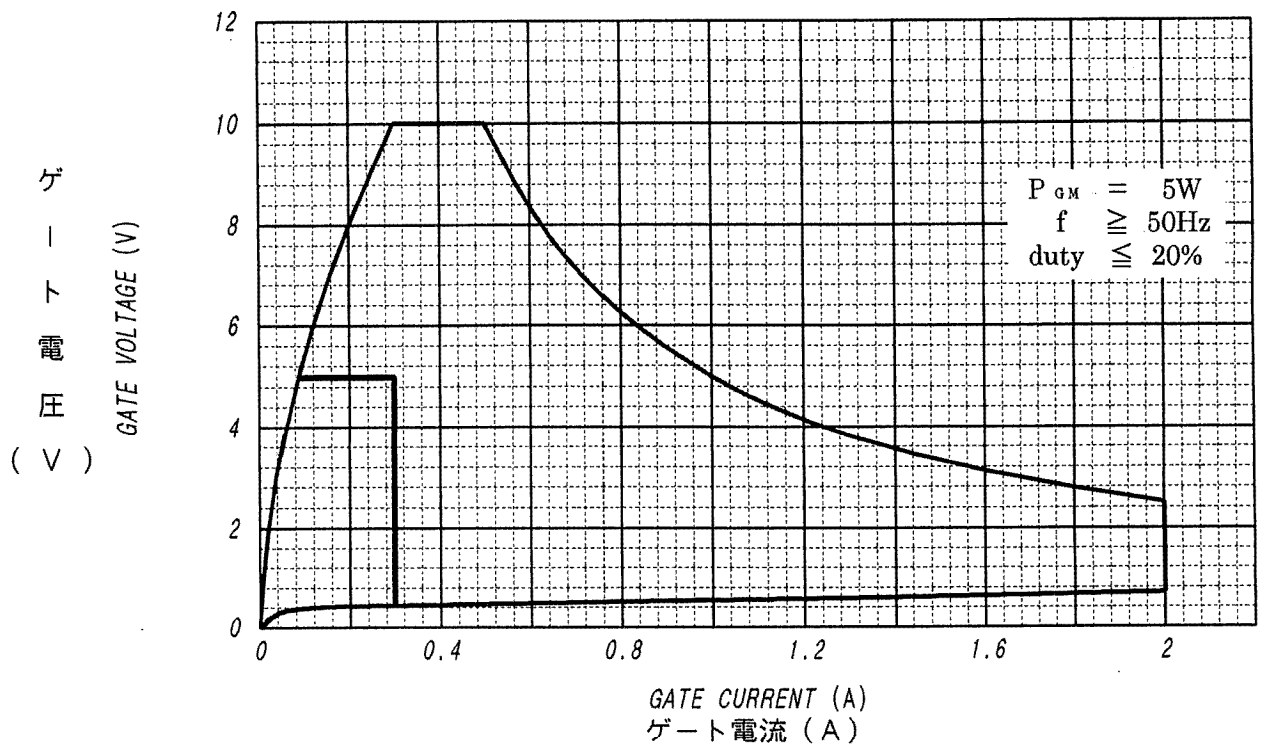

サージオン電流定格  
SURGE CURRENT RATINGS

f=50Hz, Half Sine Wave, Non-Repetitive, Tj=125°C

PDT25016 (Per 1 Arm.)

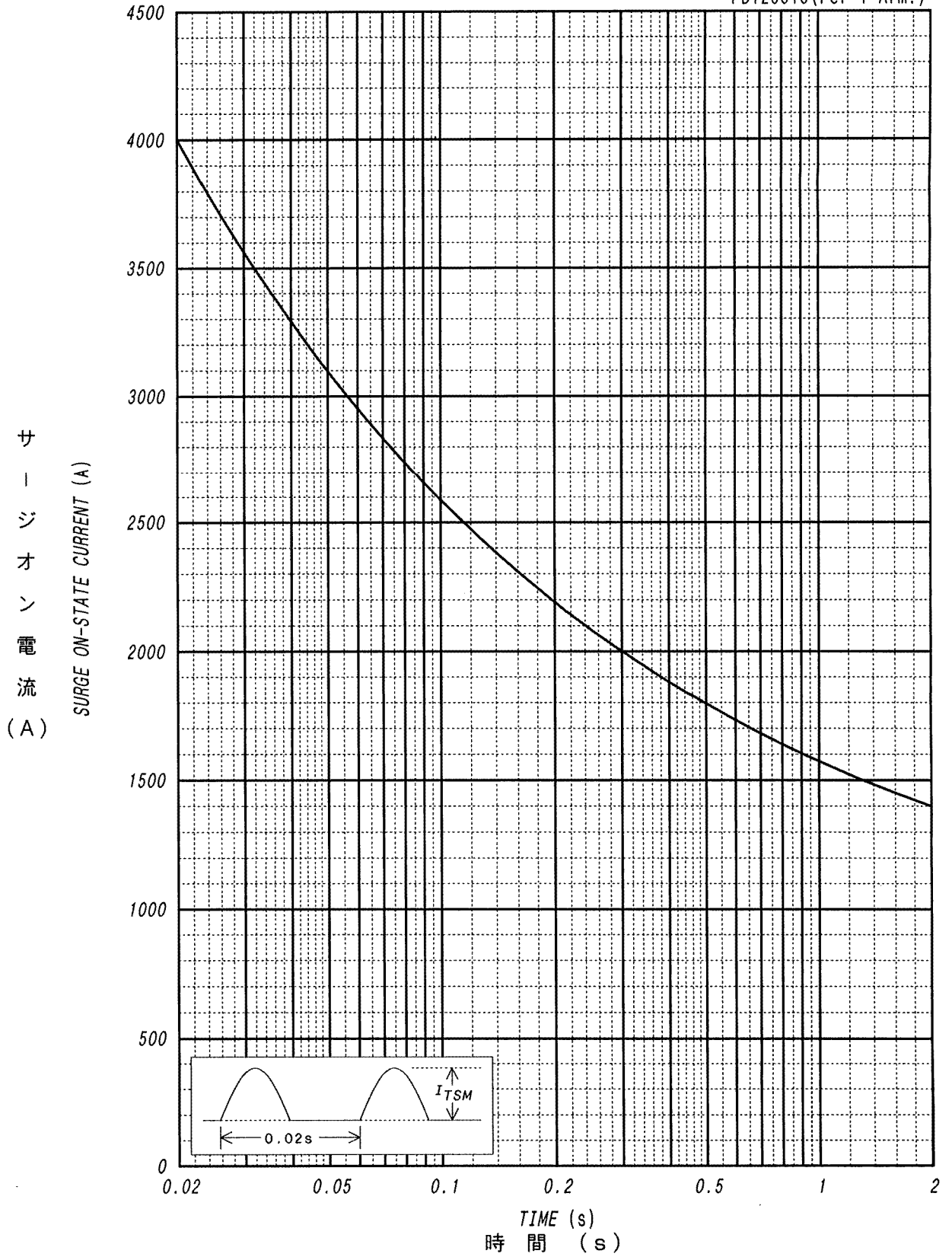

過渡熱抵抗特性  
MAXIMUM TRANSIENT THERMAL IMPEDANCE

Junction to Case

