

MATERIALS & SPECIFICATIONS

PART NO.	A25001-008	REV	ECO	DATE	APP
		D	96884	07-14-10	TLM

INSULATOR:

POLYPHENYLENE SULFIDE (PPS) PER MIL-M-24519, TYPE GST 40F.

CONTACT:

COPPER ALLOY PER MIL-DTL-83513, GOLD PLATED PER ASTM B488, (HARD GOLD) TYPE II CODE C CLASS 1.27.

TERMINATION:

COPPER ALLOY PER MIL-DTL-83513, GOLD PLATED PER ASTM B488, (HARD GOLD) TYPE II CODE C CLASS 1.27.

LATCH SPRING:

BERYLLIUM COPPER PER ASTM B194 NICKEL PLATE PER AMS-C-26074..

CURRENT CAPACITY:

3 AMP MAX.

CONTACT RESISTANCE:

26 MILLIOHMS (65mV) MAX @ 2.5 AMPS.

PERFORMANCE:

PRODUCT FAMILY TESTED TO AND PASSED THE PERFORMANCE SPECIFICATIONS OF TABLE VII OF MIL-DTL-83513.

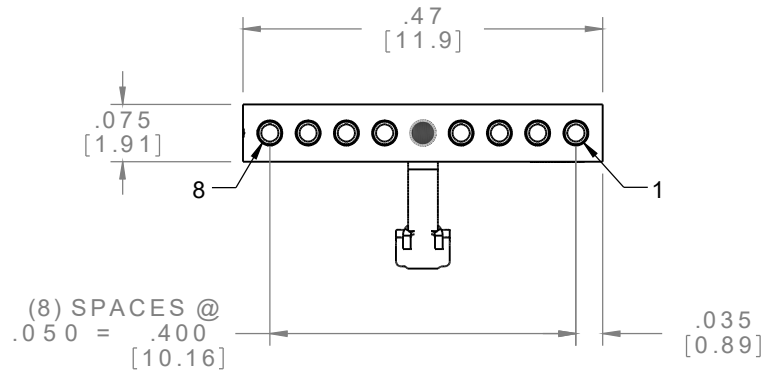

ACTUAL SIZE

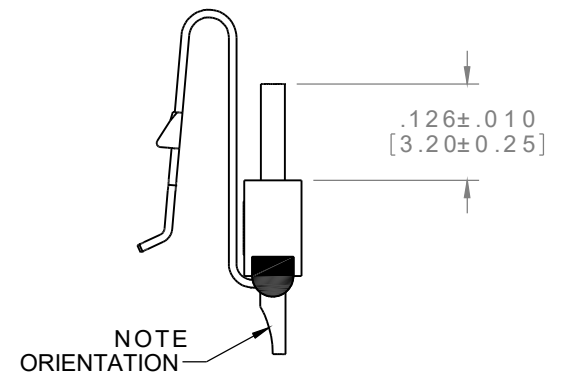
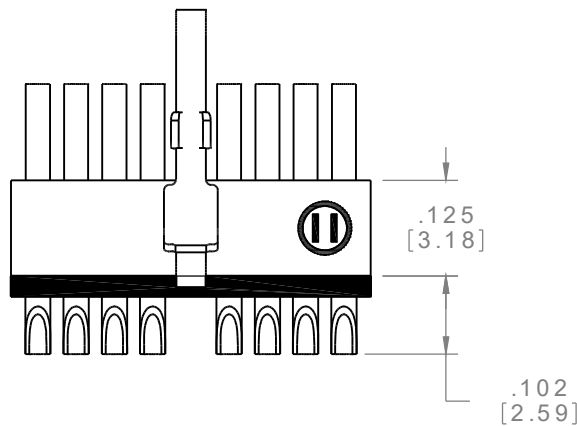

REF: OMNETICS

SSB SLDW	THIRD ANGLE
	-TOLERANCES-
	UNLESS OTHERWISE NOTED
	DIMENSIONS IN INCHES
2	PL DEC ± .01
3	PL DEC ± .005
4	PL DEC ± .0005
	ANGLES ± 1°

THIS DRAWING CONTAINS CONFIDENTIAL AND PROPRIETARY INFORMATION WHICH IS THE PROPERTY OF OMNETICS CONNECTOR CORP. THIS DOCUMENT MAY NOT, IN WHOLE OR IN PART, BE DUPLICATED, OR DISCLOSED FOR ANY PURPOSE, WITHOUT WRITTEN PERMISSION FROM OMNETICS CONNECTOR CORP.	
DFTM. DEL	DATE 09-26-02
CHK'D.	DATE
APP'D.	DATE
TITLE: (8) SOCKET FEMALE SINGLE ROW CONNECTOR W/ LATCH	

OMNETICS
CONNECTOR CORPORATION
7260 COMMERCE CIRCLE EAST
MINNEAPOLIS, MN 55432
WWW.OMNETICS.COM

CAGE CODE 61873
DWG NO. A25001-008
SHEET 1 OF 1
SCALE: 4:1
REV D