

1. Features

- Dual Antenna for 1559 – 1609 MHz and 2.4 – 2.5 GHz applications
- Wi-Fi, Bluetooth, GNSS.
- Maintains high performance with good isolation within device: DFI (Designed For Integration)
- 1.13mm diameter RF cable with I-PEX MHF connector
- Self-Adhesive mounted
- Quick integration minimizes design cycle
- High performance
- 100mm cable – (other lengths available, MOQs apply)

2. Description

Asper is a dual antenna that combines two separate antenna systems within a single flexible form factor. It is intended for use with Wi-Fi, Bluetooth with positioning applications and is designed for simple integration with plug and play simplicity. This product specification shows the performance of the antenna to cover a typical BT / Wi-Fi and GNSS bands: 2.4-2.5GHz / 1559-1609MHz.

3. Applications

- Sport cameras
- Trackers
- Dash cams
- Portable Devices
- Network Devices
- Wearable devices
- MIMO Systems

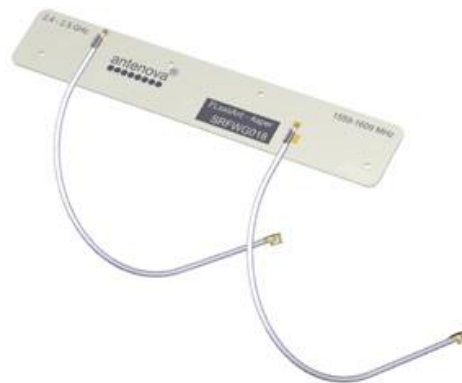

4. Part Number

Asper: SRFWG018-xxx



Note. -xxx refers to cable length option:

Part Number	Cable Length
SRFWG018-100	100mm

5. General Data

Product name	Asper
Part Number	SRFWG018
Frequency	1559 – 1609 MHz; 2.4-2.5GHz
Polarization	Linear
Operating temperature	-40°C to +85°C
Environmental condition test	ISO 16750-4 5.1.1 / 5.1.2
Impedance with matching	50 Ω
Weight	< 0.5 g
Antenna Assembly type	FPC Self-adhesive 3M 468MP
Dimensions (Antenna)	81.0 x 14.0 x 0.15 (mm)
Cable length	100 (mm)
Connection	I-PEX MHF1 (20278-112R-13)

6. RF Characteristics

	1559 – 1609 MHz	2.4 – 2.5 GHz	Conditions
Peak gain	4.25dBi	5.6dBi	All data measured in a loaded condition adhered to a plastic carrier free space.
Average gain	-1.1dBi	-0.6dBi	
Average efficiency	>75%	>85%	
Maximum return loss	-18.4dB	-14.5dB	
Maximum VSWR	1.3:1	1.4:1	

7. Antenna Patterns

7.1 RF Performance 1559-1609MHz

7.1.1 Return Loss

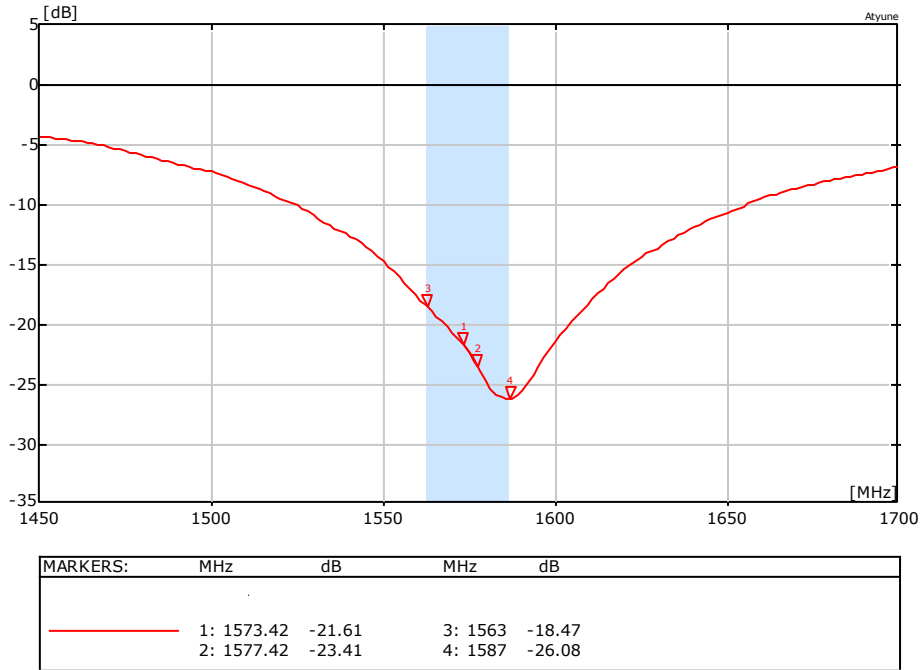

7.1.2 VSWR

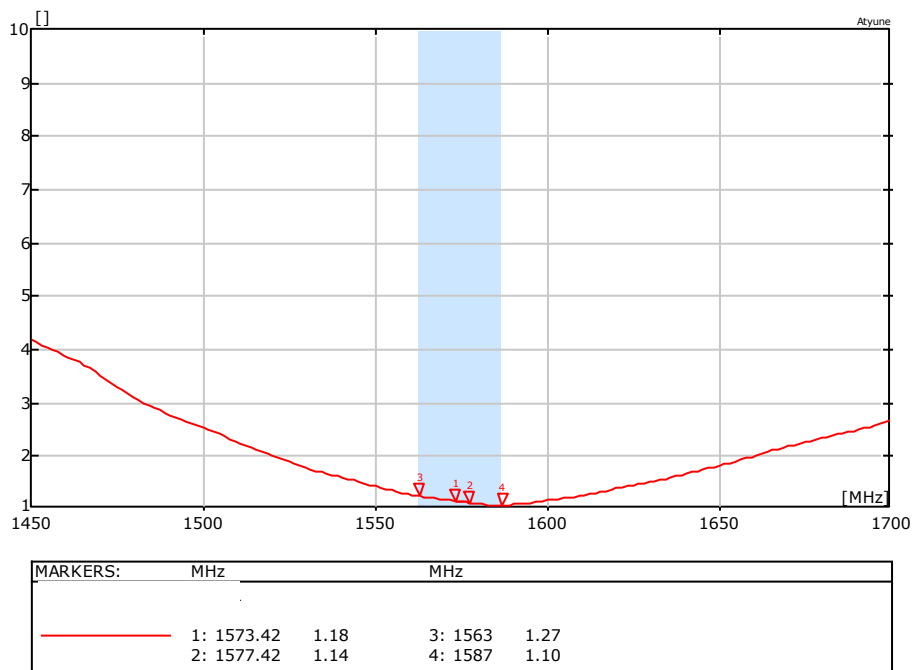

7.1.3 1559 MHz – 1609 MHz

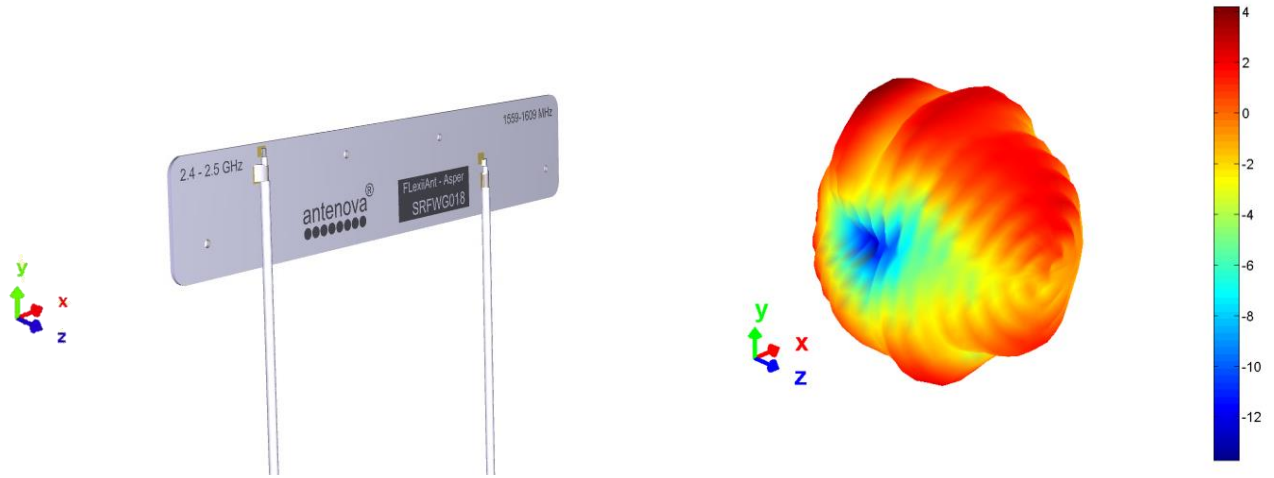

3D pattern at 1575 MHz
*Drag to rotate pattern and PCB by using Adobe Reader
(Click to Activate)*

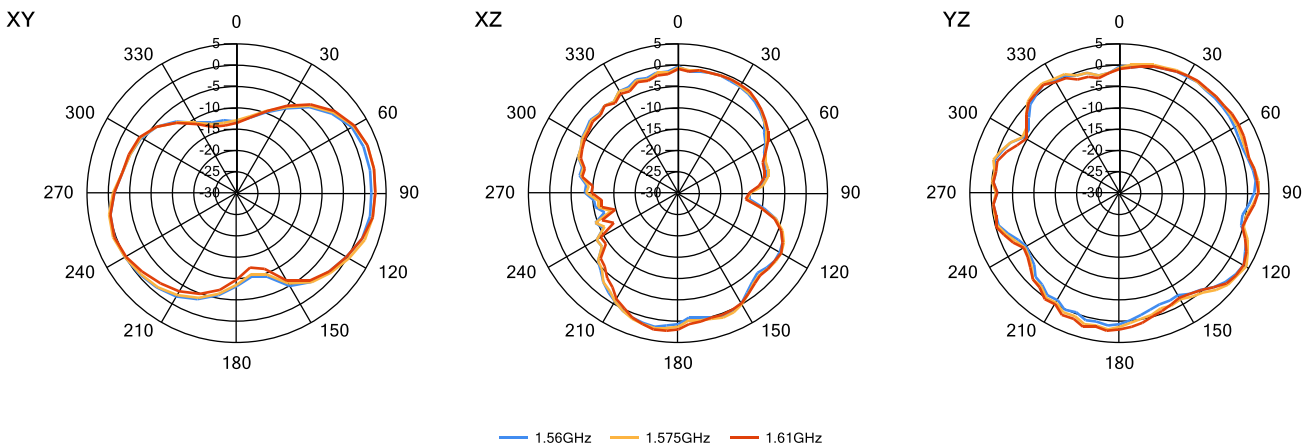

7.2 RF Performance 2.4-2.5GHz

7.2.1 Return Loss

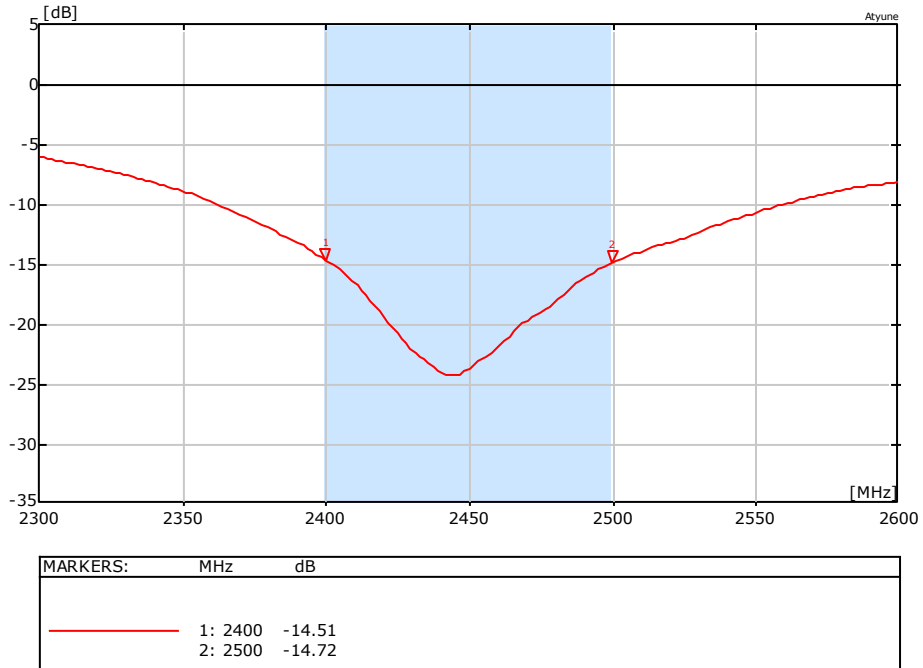

7.2.2 VSWR

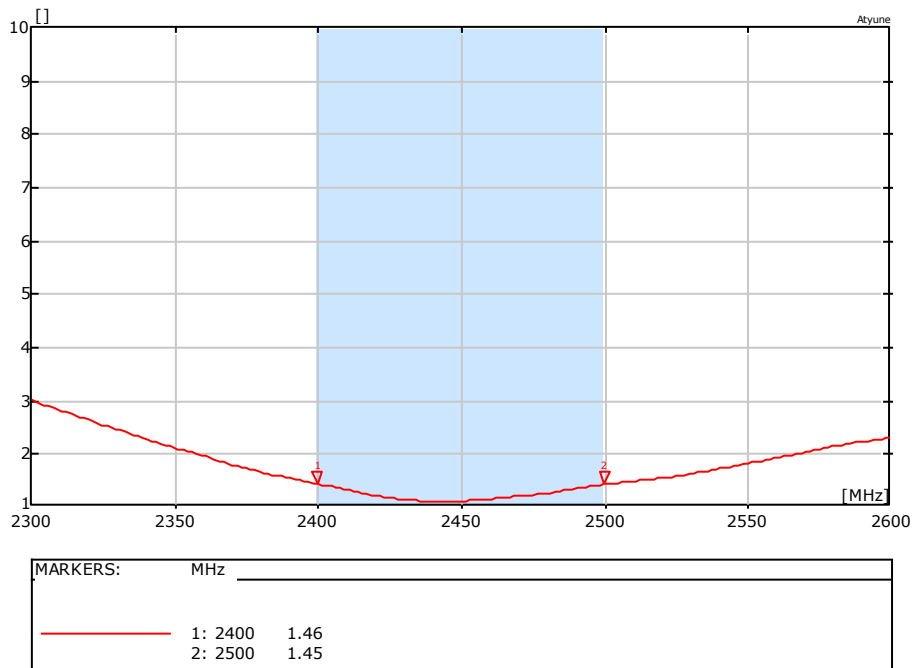

7.2.3 Antenna patterns

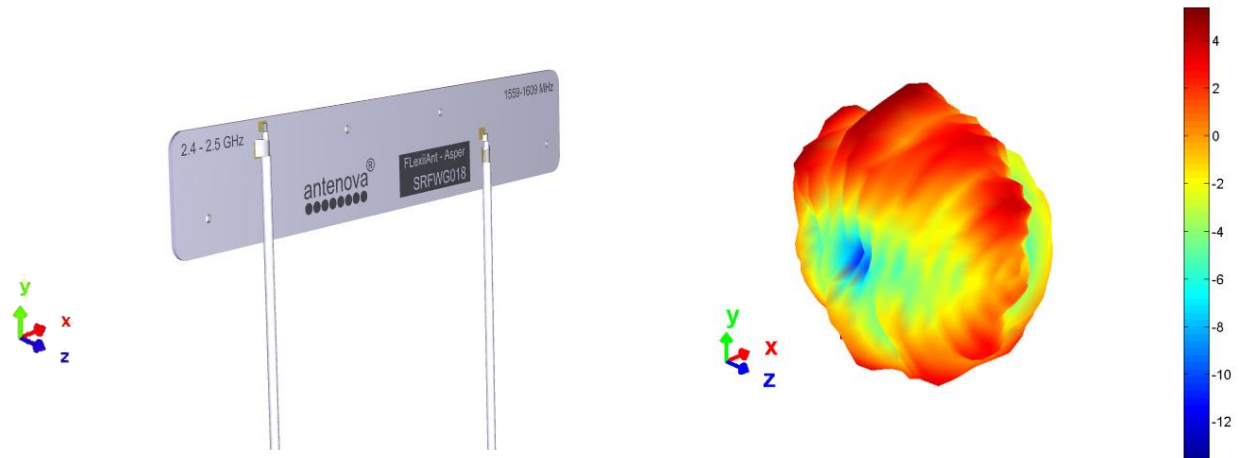

3D pattern at 2.45GHz
*Drag to rotate pattern and PCB by using Adobe Reader
(Click to Activate)*

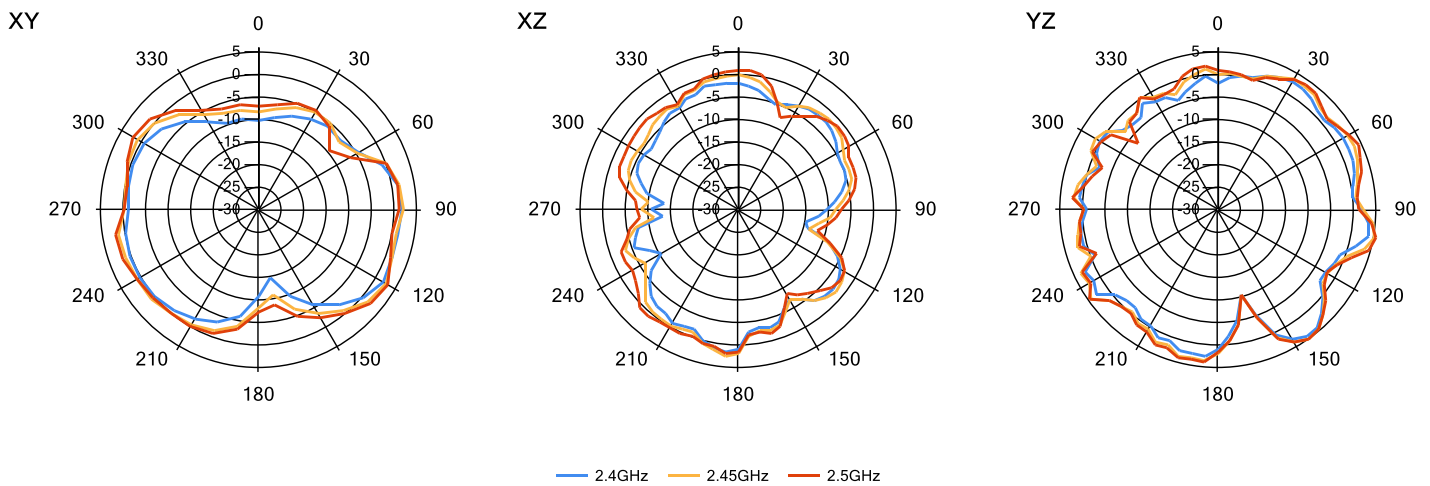

7.4 Isolation

The antennas isolation to each other is shown here tested free space. The isolation is $< -17\text{dB}$.

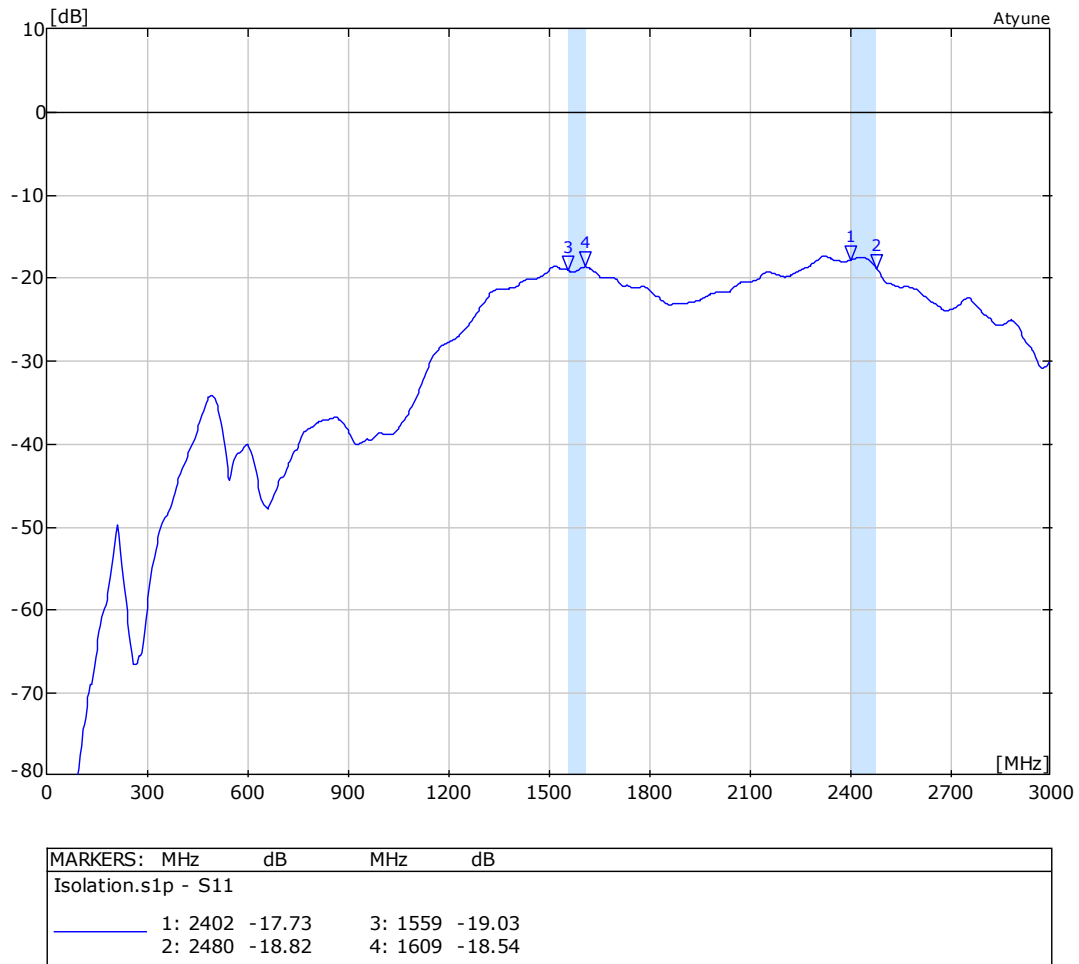

8. Antenna Dimensions

8.1 Dimensions FPC section

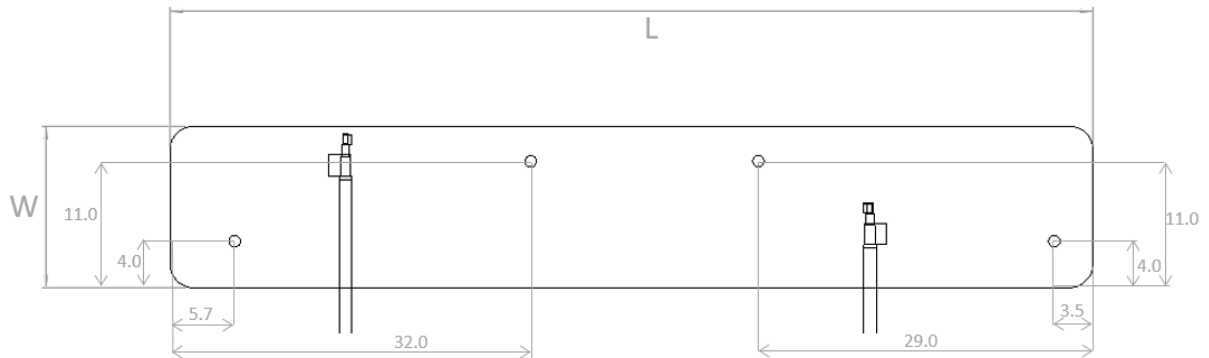

4 Holes = 1mm \varnothing (diameter)

L	W	T
Length	Width	Thickness
81.0 \pm 0.2 (mm)	14.0 \pm 0.2 (mm)	0.15 (mm) nominal

All dimensions in mm

8.2 Dimensions assembled

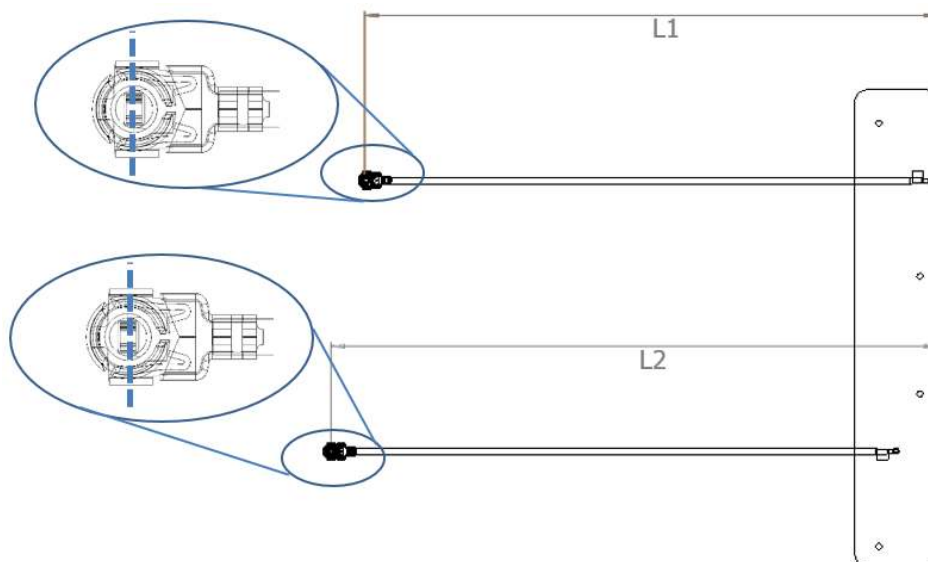

The standard cable length for this antenna is 100mm (other lengths are available, MOQs apply)

SRFWG018-100
L1 (Wi-Fi)
101 \pm 2.0 (mm)
L2 (GNSS)
107 \pm 2.0 (mm)

Antennas for Wireless Applications

8.3 I-PEX Connector MHF1 (2078-112R-13)

I-PEX	
Material	Copper Alloy
Plating	Ag

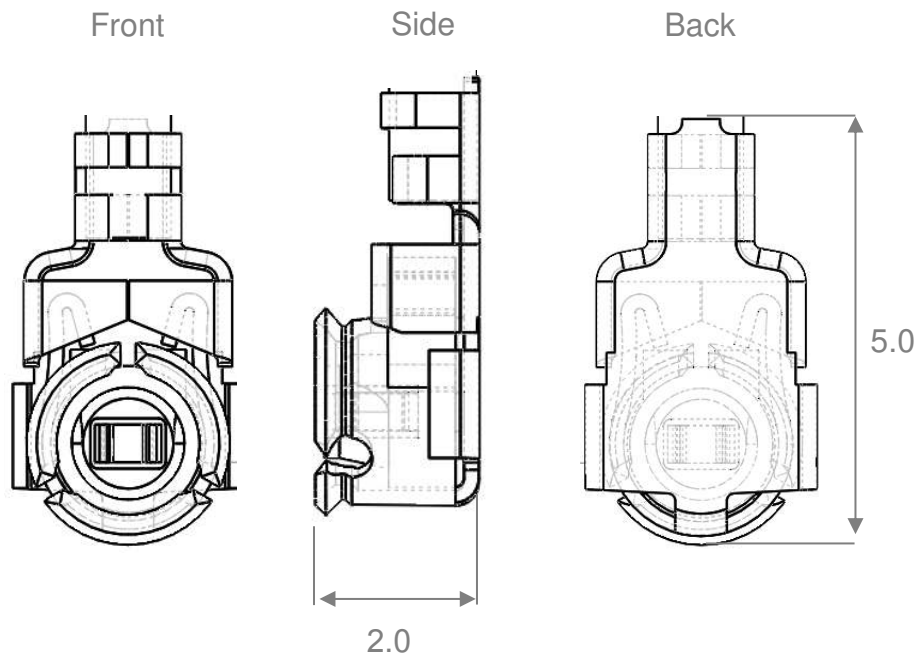

All dimensions in mm

8.4 Assembly

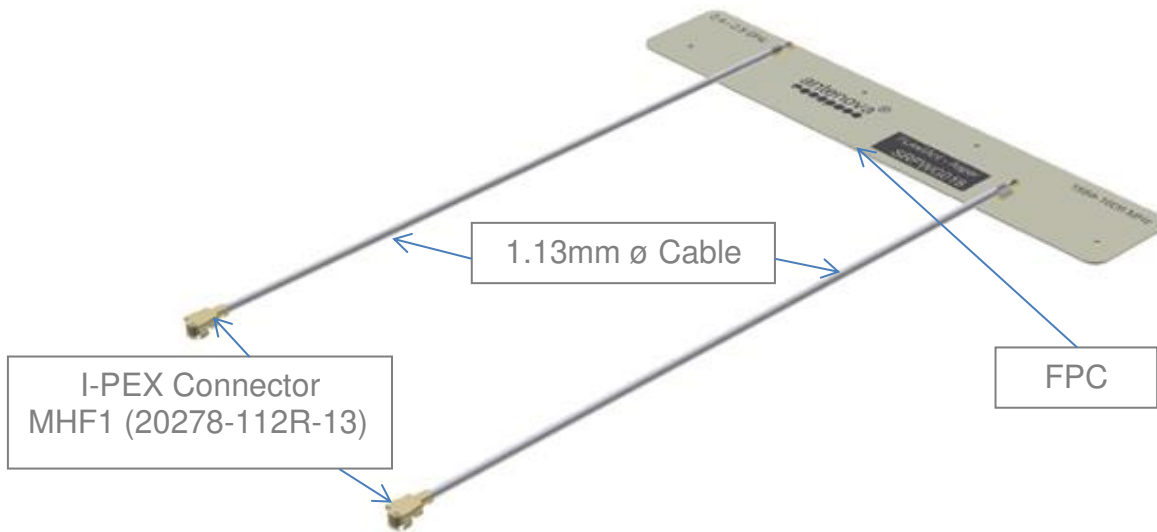

8.5 Antenna zones

The antenna contains two separate radiating structures. They are defined by the frequency band marked on the FPC and correspond to that side.

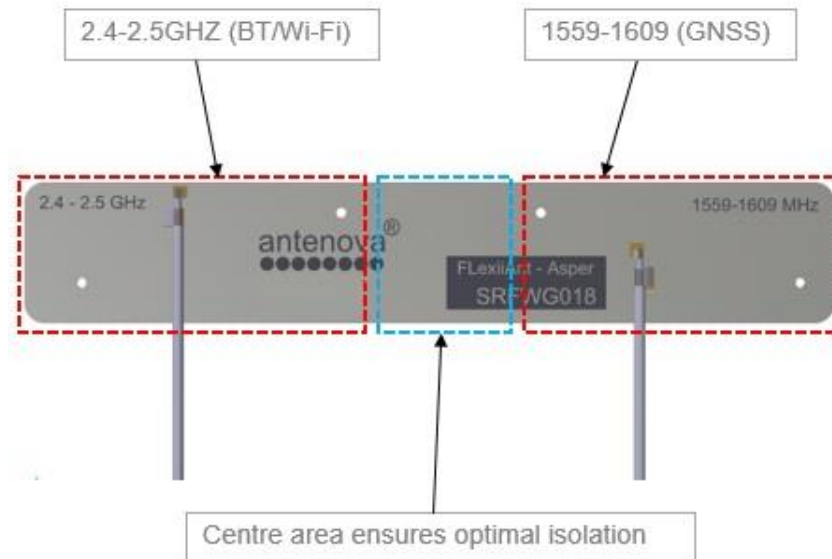

9. Electrical Interface

9.1 Host Interface

The host PCB requires the mating connector which is the I-PEX MHF (UFL) receptacle. The location should be close to the chip/modules pin for the RF. Any feed from this receptacle should be maintained at 50Ω impedance.

9.2 Transmission Line

All transmission lines should be designed to have a characteristic impedance of 50Ω.

- The length of the transmission lines should be kept to a minimum
- Any other parts of the RF system like transceivers, power amplifiers, etc, should also be designed to have an impedance of 50 Ω

Once the material for the PCB has been chosen (PCB thickness and dielectric constant), a coplanar transmission line can easily be designed using any of the commercial software packages for transmission line design. For the chosen PCB thickness, copper thickness and substrate dielectric constant, the program will calculate the appropriate transmission line width and gaps on either side of the feed.

A DC blocking capacitor should be placed in line to protect the RF front end.

9.3 Mechanical Fixing

The antenna uses 3M 468MP adhesive on the reverse side of the FPC. The antenna has an easy access split line to peel off to reveal the adhesive side. It is designed for a one time fix to a clean smooth surface.

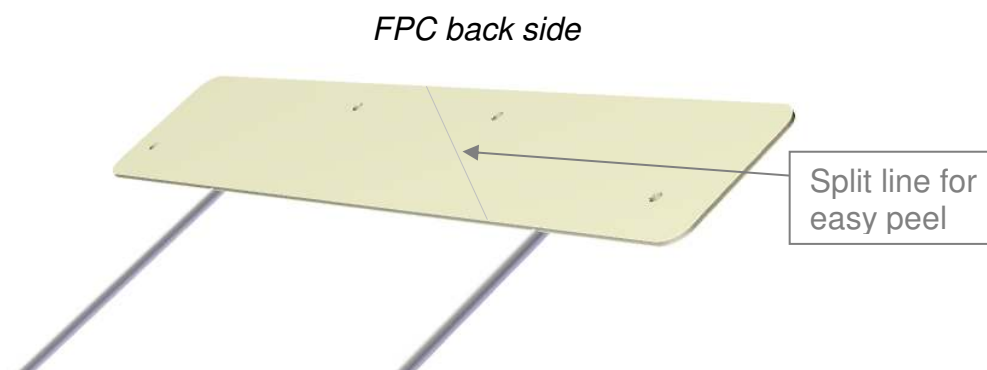

10.0 Antenna Integration Guide

10.1 Placement

For placing the FPC antenna within a device, the host PCB size is not a factor like with PCB mounted antennas. However placement still needs to follow some basic rules, as any antenna is sensitive to its environment.

Use the six spatial directions shown below as a guide. The antenna FPC section should ideally maintain a minimum of three directions free from obstructions to be able to operate effectively. The other directions will have obstacles in its path, these directions still require a minimum clearance. These minimum clearances are further defined in this section. The plastic case is not included in this, only metal objects/components that will obstruct or come in close proximity to the antenna.

Six spatial directions relative to FPC

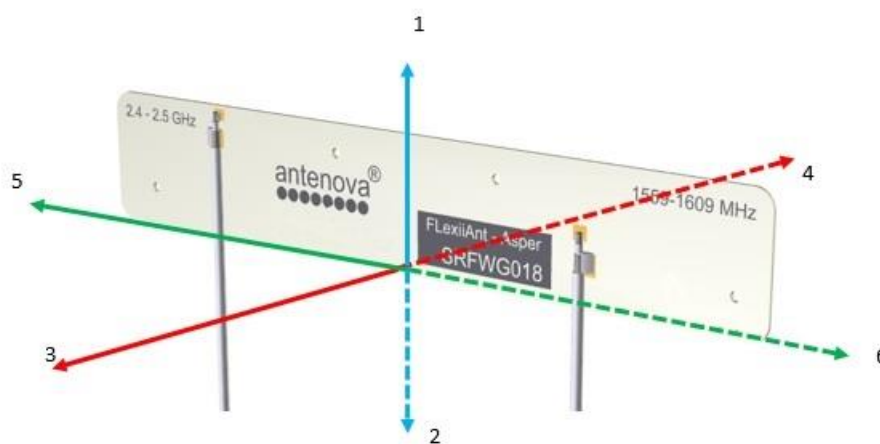

10.2 Orientation of FPC

The orientation of the FPC with respect to the host PCB should be defined depending on the unit. The proximity of the GND will have an influence on the antenna so the PCB location relative to the antenna should be considered.

The FPC will normally be placed in one of the three following options for orientation. In each option a distance (d) is the critical dimension to consider. Below shows the minimum value of (d) for each. Other obstructions may increase this dimension.

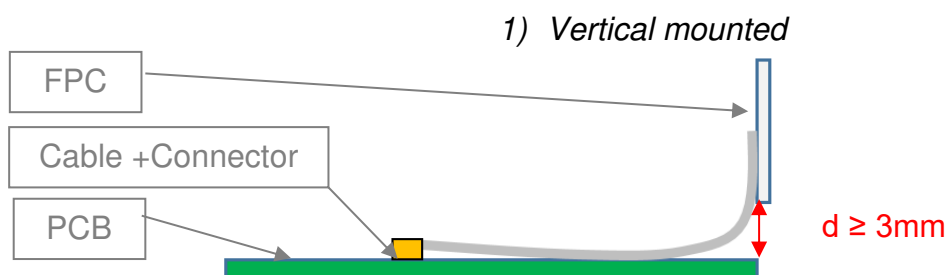

2) *Co-planar to PCB*



3) *Planar to PCB (Same plane)*



10.3 Device Integration Example

An example of the placement within a device is shown below using a sports camera. The device contains the major components along with the device outer case. The FPC is shown adhered to the inside of the device's plastic housing. The length of the cable is sufficient to allow ease of assembly when produced (SRFWG018-100).

The FPC was placed in two planes to utilise the available space. The antenna is adhered to the inside both vertically and horizontally. The GNSS section is horizontal for the best orientation, while the BT/Wi-Fi is vertically placed.

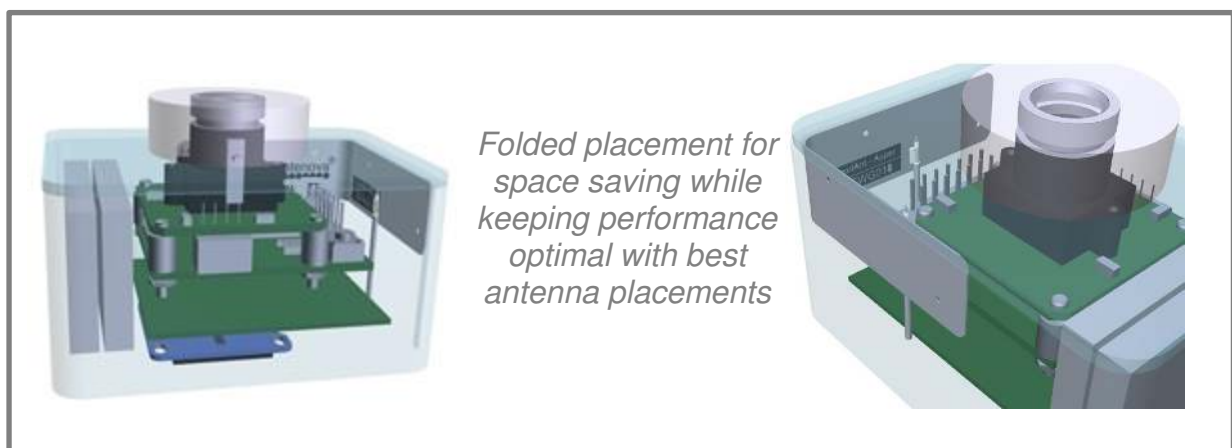
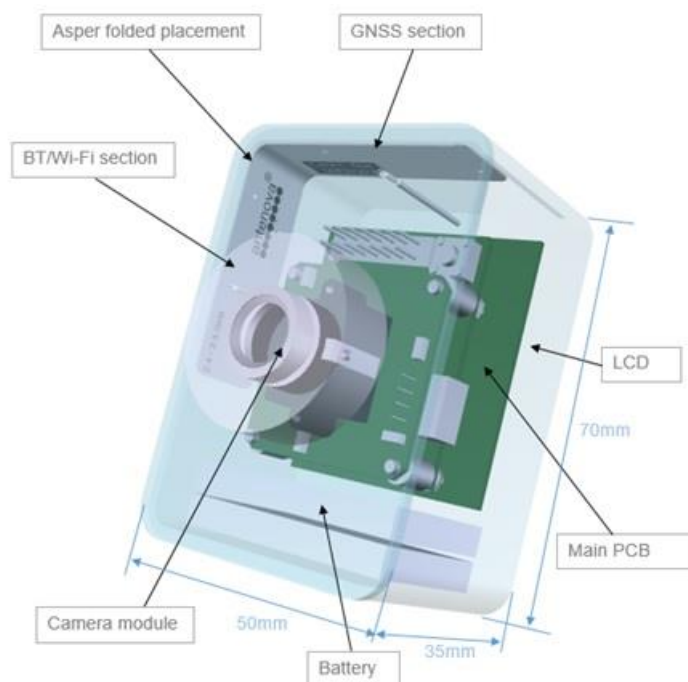

11. Hazardous Material Regulation Conformance

The antenna has been tested to conform to RoHS requirements. A certificate of conformance is available from Antenova's website.

12. Packaging

The antennas are stored in individual plastic (PE) bags, then stored within a second bag of 100 pcs.

Single antenna per bag



100 units per second bag (Labelled)



12.1 Optimal Storage Conditions

Temperature	-10°C to 40°C
Humidity	Less than 75% RH
Shelf life	18 Months
Storage place	Away from corrosive gas and direct sunlight
Packaging	Antennas should be stored in unopened sealed manufacturer's plastic packaging.

The shelf life of the antenna is 18 months, provided the bag of 100 pieces remains factory sealed.

12.2 Label Information

antenna[®] **Antenova Limited**

www.antenova.com

Description: Asper 100mm cable
Part Number: SRFWG018-100
Qty: 100 pcs
Date Code: YYWW



flexiiANT[®]

Quality statements

Antenova's products conform to REACH and RoHS legislation. For our statements regarding these and other quality standards, please see www.antenova.com.



Antenna design, integration and test resources

Product designers – the details contained in this datasheet will help you to complete your embedded antenna design. Please follow our technical advice carefully to obtain optimum antenna performance.

It is our goal that every customer will create a high performing wireless product using Antenova's antennas. You will find a wealth of design resources, calculators and case studies to aid your design at our website.

Antenova's design laboratories are equipped with the latest antenna design tools and test chambers. We provide antenna design, test and technical integration services to help you complete your design and obtain certifications.

If you cannot find the antenna you require in our product range, please contact us to discuss creating a bespoke antenna to meet your requirement exactly.

Contacts

Join our online antenna design community: ask.antenova.com

Order antenna samples and evaluation boards at: www.antenova.com

Request a quotation for antennas by volume: sales@antenova.com

Global Headquarters:

**Antenova Ltd, 2nd Floor Titan Court, 3 Bishop Square,
Hatfield, AL10 9NA +44 (0) 1223 810600**

Copyright® Antenova Ltd. All Rights Reserved. Antenova®, gigaNOVA®, RADIONOVA®, the Antenova product family names and the Antenova logos are trademarks and/or registered trademarks of Antenova Ltd. Any other names and/or trademarks belong to their respective companies. The materials provided herein are believed to be reliable and correct at the time of printing. Antenova does not warrant the accuracy or completeness of the information, text, graphics or other items contained within this information. Antenova further assumes no responsibility for the use of this information, and all such information shall be entirely at the user's risk.

Antennas for Wireless Applications