

<p>GlobTek, Inc. www.globtek.com 186 Veterans Drive, Northvale, NJ 07647 Tel. (201) 784-1000 Fax (201) 784-0111</p>	<p>Drawing Title: GTM93021-2024-P2, ICT / ITE / Medical Power Supply/Class 2/Household Power Supply, Efficiency Level: V, Case Color/Style: GlobTek Black, Potted/Encapsulated in plastic housing, Regulated Switchmode AC-DC Power Supply AC Adaptor, Input Rating: 100-240V~, 50-60 Hz, Lead Wires , Output Rating: 20W, 24.0V@0.83A, Output Configuration: 240 mm, 18/1C + Shield Cond, UL 1185, Stripped 20 +/-2mm; Tinned 6 +/-1mm or Equal, Ferrite: None, GlobTek Black, GT Cord # C2121, Pin Out: White Conductor (+V), Shield (-V), Blades/Input Cord: 200mm, 2* 18 AWG 1 conductor, UL 1015, solid, Black & White, Approvals: EAC; UKCA; Ukraine; China RoHS; WEEE; Double Insulation; PSE; Fuse 60335; CB EN/IEC 60335-1; CE; NEMKO EN/IEC 60335-1; RoHS; VCCI; cETLus UL1310; IP68; UL 1310; UL 1310; Fuse 60335; 61558-1; IEC 61558-1;</p>
	<p>Model No. GTM93021-2024-P2</p>
	<p>Part No./Ordering No. PR9SI830A00CHM(RVB) Rev C</p>

In Addition to GlobTek Inc.'s renewed ISO9001:2015 - Quality Management System Certification, GlobTek Inc. is now certified to:

ISO13485:2016 - Medical Devices Quality Management System Certification
ISO14001:2015 - Environmental Management System Certification

ISO Certificates are available online at <https://www.globtek.com/iso-certificates/>

The acceptance of this specification and use of the product described in this document indicates the acceptance and binding of the customer to Globtek TERMS AND CONDITIONS (attached to the end of this document), which supersede all other agreements, terms, and conditions (<https://en.globtek.com/terms-and-conditions/>).

The purchaser of this product (Customer) agrees that it is their sole responsibility to determine suitability/fitness of the product described in this specification for their application and to take precautions for protection against any hazards attendant to the handling and use of the product.

Footnote:

GlobTek Inc. will not be liable for the safety and performance of these power supplies/battery packs if unauthorized access and repair occurs. End user should consult applicable UL, CSA or EN standards for proper installation instruction.

Limitation of Use:

GlobTek products are intended for use with commercial, medical, and/or industrial equipment only. GlobTek product are not authorized for use as mission critical components in life support hazardous environment, nuclear or aircraft applications without prior written approval from the CEO of GlobTek Inc.

Contents of this document are subject to change without prior notice.

Customer Approval of Specification:

Please approve, sign and send back to GlobTek so we can complete order processing.
A delay in receipt of this form will delay delivery schedule.

Company Name: _____	Customer P/N: _____
Quote Number: _____	Date: _____
Authorized Representative Name: _____	Authorized Representative Signature: _____

GloTek, Inc. www.globtek.com 186 Veterans Drive, Northvale, NJ 07647 Tel. (201) 784-1000 Fax (201) 784-0111	Drawing Title: GTM93021-2024-P2, ICT / ITE / Medical Power Supply/Class 2/Household Power Supply, Efficiency Level: V, Case Color/Style: GlobTek Black, Potted/Encapsulated in plastic housing, Regulated Switchmode AC-DC Power Supply AC Adaptor, Input Rating: 100-240V~, 50-60 Hz, Lead Wires , Output Rating: 20W, 24.0V@0.83A, Output Configuration: 240 mm, 18/1C + Shield Cond, UL 1185, Stripped 20 +2/-2mm; Tinned 6 +/-1mm or Equal, Ferrite: None, GlobTek Black, GT Cord # C2121, Pin Out: White Conductor (+V), Shield (-V), Blades/Input Cord: 200mm, 2* 18 AWG 1 conductor, UL 1015, solid, Black & White, Approvals: EAC; UKCA; Ukraine; China RoHS; WEEE; Double Insulation; PSE; Fuse 60335; CB EN/IEC 60335-1; CE; NEMKO EN/IEC 60335-1; RoHS; VCCI; cETLus UL1310; IP68; UL 1310; UL 1310; Fuse 60335; 61558-1; IEC 61558-1;	
	Model No. GTM93021-2024-P2	
	Part No./Ordering No. PR9SI830A00CHM(RVB)	Rev C

REVISION HISTORY

REV	DESCRIPTION	SUB	DATE	APPROVED
C	Added grounding configuration F2	bsiep	06/19/2019	QA
B	Update enclosure drawing	rchiu	10/13/2017	QA
A	Initial Release	GTde1	08/23/2017	QA

POWER SUPPLY INFORMATION

TYPE	Potted/Encapsulated in plastic housing
TECHNOLOGY	Regulated Switchmode AC-DC Power Supply AC Adaptor
CASE COLOR	GlobTek Black
NAMEPLATE RATED INPUT	100-240V~, 50-60 Hz, 0.6 A Max
INPUT CONFIG	Lead Wires
WATTS	20.00
VOLTS OUT	24.0
CURRENT OUT (Amps)	0.83
BLADE/CORD INCLUDED	FC-Lead Wire 200 200mm, 2* 18 AWG 1 conductor, UL 1015, solid, Black & White
BLADE/CORD INSTALLED	FC-Lead Wire 200 :200mm, 2* 18 AWG 1 conductor, UL 1015, solid, Black & White
INGRESS PROTECTION	IP68
GROUNDING CONFIGURATION	(F1) Class II / Double Insulated
EFFICIENCY LEVEL	V
OUTPUT CONFIGURATION	240 mm, 18/1C + Shield Cond, UL 1185, Stripped 20 +2/-2mm; Tinned 6 +/-1mm or Equal, Ferrite: None, GlobTek Black, GT Cord # C2121
CONNECTOR PIN OUT	White Conductor (+V), Shield (-V)
LABEL SPECS	Standard GT,L-1186
SPECIAL BARCODE LABEL MATERIAL	No
PACK SPEC	Standard Potted, Individually Box.gif
USER MANUAL	

<p>GlobTek, Inc. www.globtek.com 186 Veterans Drive, Northvale, NJ 07647 Tel. (201) 784-1000 Fax (201) 784-0111</p>	<p>Drawing Title: GTM93021-2024-P2, ICT / ITE / Medical Power Supply/Class 2/Household Power Supply, Efficiency Level: V, Case Color/Style: GlobTek Black, Potted/Encapsulated in plastic housing, Regulated Switchmode AC-DC Power Supply AC Adaptor, Input Rating: 100-240V~, 50-60 Hz, Lead Wires , Output Rating: 20W, 24.0V@0.83A, Output Configuration: 240 mm, 18/1C + Shield Cond, UL 1185, Stripped 20 +2/-2mm; Tinned 6 +/-1mm or Equal, Ferrite: None, GlobTek Black, GT Cord # C2121, Pin Out: White Conductor (+V), Shield (-V), Blades/Input Cord: 200mm, 2* 18 AWG 1 conductor, UL 1015, solid, Black & White, Approvals: EAC; UKCA; Ukraine; China RoHS; WEEE; Double Insulation; PSE; Fuse 60335; CB EN/IEC 60335-1; CE; NEMKO EN/IEC 60335-1; RoHS; VCCI; cETLus UL1310; IP68; UL 1310; UL 1310; Fuse 60335; 61558-1; IEC 61558-1;</p> <p>Model No. GTM93021-2024-P2</p> <p>Part No./Ordering No. PR9SI830A00CHM(RVB)</p>	<p>Rev C</p>
--	---	--------------

Notes/Modifications/Customizations (notes in this section supersede the values shown in the standard spec)

DIMENSIONS ARE IN MM UNLESS SPECIFIED OTHERWISE

Warning Label:



BACKGROUND:BLACK
TEXT:WHITE

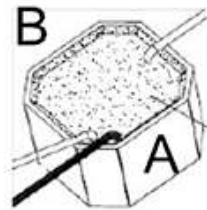

ATTACHED ON A SIDE



BACKGROUND:BLACK
TEXT:WHITE

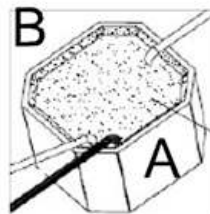

ATTACHED ON B SIDE

GloTek, Inc. www.globtek.com 186 Veterans Drive, Northvale, NJ 07647 Tel. (201) 784-1000 Fax (201) 784-0111	Drawing Title: GTM93021-2024-P2, ICT / ITE / Medical Power Supply/Class 2/Household Power Supply, Efficiency Level: V, Case Color/Style: GlobTek Black, Potted/Encapsulated in plastic housing, Regulated Switchmode AC-DC Power Supply AC Adaptor, Input Rating: 100-240V~, 50-60 Hz, Lead Wires , Output Rating: 20W, 24.0V@0.83A, Output Configuration: 240 mm, 18/1C + Shield Cond, UL 1185, Stripped 20 +2/-2mm; Tinned 6 +/-1mm or Equal, Ferrite: None, GlobTek Black, GT Cord # C2121, Pin Out: White Conductor (+V), Shield (-V), Blades/Input Cord: 200mm, 2* 18 AWG 1 conductor, UL 1015, solid, Black & White, Approvals: EAC; UKCA; Ukraine; China RoHS; WEEE; Double Insulation; PSE; Fuse 60335; CB EN/IEC 60335-1; CE; NEMKO EN/IEC 60335-1; RoHS; VCCI; cETLus UL1310; IP68; UL 1310; UL 1310; Fuse 60335; 61558-1; IEC 61558-1;	
	Model No. GTM93021-2024-P2	
	Part No./Ordering No. PR9SI830A00CHM(RVB)	Rev C

ELECTRICAL SPECIFICATIONS

A) ELECTRICAL SPECIFICATIONS:

01. Input Voltage: Specified 90-264 Vac, Nameplate rated: 100-240Vac
02. Input Frequency: Specified 47-63 Hz, Nameplate rated 50-60Hz
03. Output Regulation: +/- 5% measured at the output connector
04. Line Voltage Regulation: +/- 1% typical measured at full load
05. Output Ripple (Vp-p): +/-1% or 150 mV whichever is greater, measured at 20 MHz bandwidth with 0.1 uf ceramic capacitor in parallel with 10 uf electrolytic capacitor connected at the end of the output connector at nominal line
06. Turn-ON/OFF Overshoot: 5% maximum, 1 mS typical recovery time for 25% to 50% step load
07. Turn-ON Delay: 3000 mS, maximum @ full load, nominal line
08. Hold-Up Time: 8 mS typical @ nominal input voltage and full load
09. Inrush Current: 30A maximum cold start @ 240Vac input
10. Switching Frequency: 65 KHz typical

B) PROTECTION

01. Over-Voltage: Electronically Protected Zener clamp across the output
02. Short Circuit: Electronically Protected unit will auto recover upon removal of fault
04. Input Protection: Input line and neutral fusing

C) SAFETY

01. Dielectric Withstand Voltage: 4242Vdc from primary to secondary
02. Touch Current: Maximum allowed values: 100uA NC(Normal condition) 500uA SFC(single fault condition)
03. Earth continuity test:<0.1 Ohm or < 0.2 Ohm when with a non-detachable Power Supply cord, Class I Only
04. ROHS 2: Complies with EU 2011/65/EU and China SJ/T 11363-2006

D) OTHER:

01. MTBF: 200,000 Hours @ 25°C ambient temperature
02. Operating Temperature: 0°C to 50°C ambient temperature
03. Humidity: 0% to 90% relative humidity
04. Storage Temperature: -10°C to 80°C
05. Cooling: Convection

E) ENCLOSURE

01. Housing: High impact plastic, 94V0 polycarbonate, non-vented
02. Size: 48.0 Length x 51.0 Width x 35.0 High mm +/-1.0 mm suitable for installation in North American 1-Gang Old Work Electrical Box / typical unterputz Power Supply (netzteil) for "Hohlwanddose" per VDE0606 (Einbau-Netzteil Stromversorgung für Unterputz-Installation)
03. Markings: Label and/or Pad Printed and/or Molded in the case

TO ADDRESS SYSTEM-LEVEL EMI CONCERNS, FERRITE CHOKES/BEADS MAY BE ADDED/REVISED UPON REQUEST. A SAMPLE KIT OF GLOBTEK'S STANDARD FERRITES IS AVAILABLE UNDER GLOBTEK P/N: EMI-MITIGATION-KIT1

FOR ADDITIONAL INFORMATION, PLEASE READ OUR WHITE PAPER AT: <https://r.globtek.info/3QeaqtD>

PROPRIETARY INFORMATION

PROPRIETARY OF GLOBTEK, INC. ANY REPRODUCTION, DISCLOSURE OR USE OF THIS DRAWING, IN WHOLE OR IN PART, IS HEREBY PROHIBITED EXCEPT AS SPECIFIED IN WRITING BY GLOBTEK, INC. © GlobTek, Inc. 2015 - 2023

<p>GlobTek, Inc. www.globtek.com 186 Veterans Drive, Northvale, NJ 07647 Tel. (201) 784-1000 Fax (201) 784-0111</p>	<p>Drawing Title: GTM93021-2024-P2, ICT / ITE / Medical Power Supply/Class 2/Household Power Supply, Efficiency Level: V, Case Color/Style: GlobTek Black, Potted/Encapsulated in plastic housing, Regulated Switchmode AC-DC Power Supply AC Adaptor, Input Rating: 100-240V~, 50-60 Hz, Lead Wires , Output Rating: 20W, 24.0V@0.83A, Output Configuration: 240 mm, 18/1C + Shield Cond, UL 1185, Stripped 20 +/-2mm; Tinned 6 +/-1mm or Equal, Ferrite: None, GlobTek Black, GT Cord # C2121, Pin Out: White Conductor (+V), Shield (-V), Blades/Input Cord: 200mm, 2* 18 AWG 1 conductor, UL 1015, solid, Black & White, Approvals: EAC; UKCA; Ukraine; China RoHS; WEEE; Double Insulation; PSE; Fuse 60335; CB EN/IEC 60335-1; CE; NEMKO EN/IEC 60335-1; RoHS; VCCI; cETLus UL1310; IP68; UL 1310; UL 1310; Fuse 60335; 61558-1; IEC 61558-1;</p>
	<p>Model No. GTM93021-2024-P2</p>
	<p>Part No./Ordering No. PR9SI830A00CHM(RVB) Rev C</p>

INGRESS PROTECTION: IP68

<p>GlobTek, Inc. www.globtek.com 186 Veterans Drive, Northvale, NJ 07647 Tel. (201) 784-1000 Fax (201) 784-0111</p>	<p>Drawing Title: GTM93021-2024-P2, ICT / ITE / Medical Power Supply/Class 2/Household Power Supply, Efficiency Level: V, Case Color/Style: GlobTek Black, Potted/Encapsulated in plastic housing, Regulated Switchmode AC-DC Power Supply AC Adaptor, Input Rating: 100-240V~, 50-60 Hz, Lead Wires , Output Rating: 20W, 24.0V@0.83A, Output Configuration: 240 mm, 18/1C + Shield Cond, UL 1185, Stripped 20 +/-2mm; Tinned 6 +/-1mm or Equal, Ferrite: None, GlobTek Black, GT Cord # C2121, Pin Out: White Conductor (+V), Shield (-V), Blades/Input Cord: 200mm, 2* 18 AWG 1 conductor, UL 1015, solid, Black & White, Approvals: EAC; UKCA; Ukraine; China RoHS; WEEE; Double Insulation; PSE; Fuse 60335; CB EN/IEC 60335-1; CE; NEMKO EN/IEC 60335-1; RoHS; VCCI; cETLus UL1310; IP68; UL 1310; UL 1310; Fuse 60335; 61558-1; IEC 61558-1;</p>
	<p>Model No. GTM93021-2024-P2</p>
	<p>Part No./Ordering No. PR9SI830A00CHM(RVB) Rev C</p>

Mechanical drawing

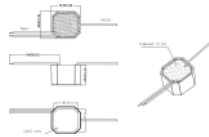

<p>GlobTek, Inc. www.globtek.com 186 Veterans Drive, Northvale, NJ 07647 Tel. (201) 784-1000 Fax (201) 784-0111</p>	<p>Drawing Title: GTM93021-2024-P2, ICT / ITE / Medical Power Supply/Class 2/Household Power Supply, Efficiency Level: V, Case Color/Style: GlobTek Black, Potted/Encapsulated in plastic housing, Regulated Switchmode AC-DC Power Supply AC Adaptor, Input Rating: 100-240V~, 50-60 Hz, Lead Wires , Output Rating: 20W, 24.0V@0.83A, Output Configuration: 240 mm, 18/1C + Shield Cond, UL 1185, Stripped 20 +/-2mm; Tinned 6 +/-1mm or Equal, Ferrite: None, GlobTek Black, GT Cord # C2121, Pin Out: White Conductor (+V), Shield (-V), Blades/Input Cord: 200mm, 2* 18 AWG 1 conductor, UL 1015, solid, Black & White, Approvals: EAC; UKCA; Ukraine; China RoHS; WEEE; Double Insulation; PSE; Fuse 60335; CB EN/IEC 60335-1; CE; NEMKO EN/IEC 60335-1; RoHS; VCCI; cETLus UL1310; IP68; UL 1310; UL 1310; Fuse 60335; 61558-1; IEC 61558-1;</p>	<p>Model No. GTM93021-2024-P2</p> <hr/> <p>Part No./Ordering No. PR9SI830A00CHM(RVB) Rev C</p>
--	---	---

DERATING CURVE

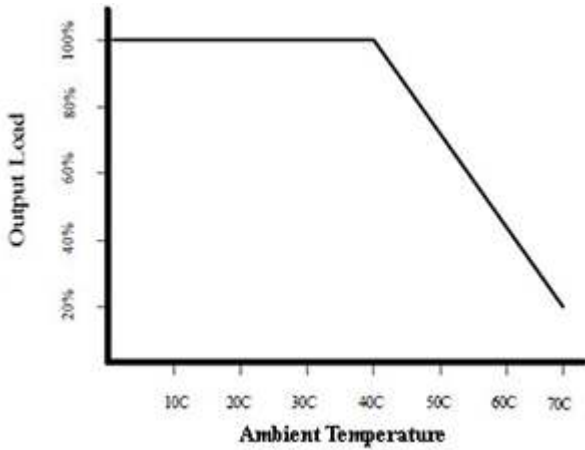

<p>GlobTek, Inc. www.globtek.com 186 Veterans Drive, Northvale, NJ 07647 Tel. (201) 784-1000 Fax (201) 784-0111</p>	Drawing Title: GTM93021-2024-P2, ICT / ITE / Medical Power Supply/Class 2/Household Power Supply, Efficiency Level: V, Case Color/Style: GlobTek Black, Potted/Encapsulated in plastic housing, Regulated Switchmode AC-DC Power Supply AC Adaptor, Input Rating: 100-240V~, 50-60 Hz, Lead Wires , Output Rating: 20W, 24.0V@0.83A, Output Configuration: 240 mm, 18/1C + Shield Cond, UL 1185, Stripped 20 +/-2mm; Tinned 6 +/-1mm or Equal, Ferrite: None, GlobTek Black, GT Cord # C2121, Pin Out: White Conductor (+V), Shield (-V), Blades/Input Cord: 200mm, 2* 18 AWG 1 conductor, UL 1015, solid, Black & White, Approvals: EAC; UKCA; Ukraine; China RoHS; WEEE; Double Insulation; PSE; Fuse 60335; CB EN/IEC 60335-1; CE; NEMKO EN/IEC 60335-1; RoHS; VCCI; cETLus UL1310; IP68; UL 1310; UL 1310; Fuse 60335; 61558-1; IEC 61558-1;	
	Model No. GTM93021-2024-P2	
	Part No./Ordering No. PR9SI830A00CHM(RVB)	Rev C

INPUT CONFIGURATION

(F1) Class II / Double Insulated



[Alternate grounding configurations](#) available upon request.

Blades/Cord Included:FC-Lead Wire 200:200mm, 2* 18 AWG 1 conductor, UL 1015, solid, Black & White

Blades/Cord Installed:FC-Lead Wire 200:200mm, 2* 18 AWG 1 conductor, UL 1015, solid, Black & White

Contact GlobTek for customization requests on any type of cable in any customer specified lengths.

GlobTek, Inc. www.globtek.com 186 Veterans Drive, Northvale, NJ 07647 Tel. (201) 784-1000 Fax (201) 784-0111	Drawing Title: GTM93021-2024-P2, ICT / ITE / Medical Power Supply/Class 2/Household Power Supply, Efficiency Level: V, Case Color/Style: GlobTek Black, Potted/Encapsulated in plastic housing, Regulated Switchmode AC-DC Power Supply AC Adaptor, Input Rating: 100-240V~, 50-60 Hz, Lead Wires , Output Rating: 20W, 24.0V@0.83A, Output Configuration: 240 mm, 18/1C + Shield Cond, UL 1185, Stripped 20 +2/-2mm; Tinned 6 +/-1mm or Equal, Ferrite: None, GlobTek Black, GT Cord # C2121, Pin Out: White Conductor (+V), Shield (-V), Blades/Input Cord: 200mm, 2* 18 AWG 1 conductor, UL 1015, solid, Black & White, Approvals: EAC; UKCA; Ukraine; China RoHS; WEEE; Double Insulation; PSE; Fuse 60335; CB EN/IEC 60335-1; CE; NEMKO EN/IEC 60335-1; RoHS; VCCI; cETLus UL1310; IP68; UL 1310; UL 1310; Fuse 60335; 61558-1; IEC 61558-1;	
	Model No. GTM93021-2024-P2	
	Part No./Ordering No. PR9SI830A00CHM(RVB)	Rev C

OUTPUT CORD AND CONNECTOR: A103/C2121

ACTUAL CONNECTORS, OVERMOLDS, FERRITES MAY VARY SLIGHTLY FROM THE PICTURE BELOW

CABLE TYPE	UL 1185
CABLE LENGTH (mm)	240
CABLE TOLERANCE (mm)	± 20
WIRE GAUGE (AWG)	18
CONDUCTORS	1C + Shield
HANK DIMENSION (mm)	Standard
CABLE / CONNECTOR OVERMOLD COLOR	GlobTek Black
FERRITE TYPE AND DIMENSION	None
FERRITE NUMBER OF TURNS (Definition)	N/A
FERRITE DIMENSION FROM STRAIN RELIEF	N/A
FERRITE DIMENSION FROM PLUG	N/A
PLUG TYPE	Stripped 20 +2/-2mm; Tinned 6 +/-1mm or Equal
OVER MOLD ORIENTATION	N/A
CONNECTOR PIN OUT	White Conductor (+V), Shield (-V)

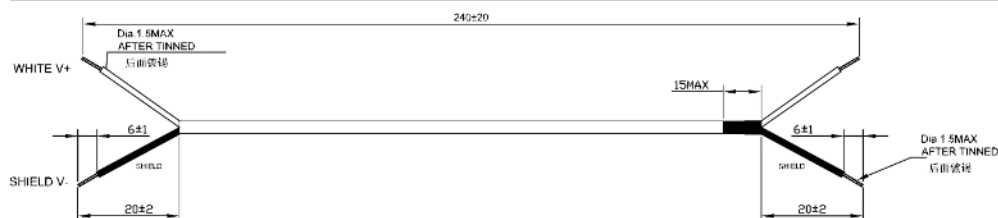

ADDITIONAL OUTPUT PLUG OPTIONS ARE AVAILABLE AT <https://www.globtek.com/connectors/>
STANDARD PLUGS AND CONNECTORS CAN BE SEEN ONLINE AT <https://www.globtek.com/connectors/>
CALCULATE VOLTAGE REGULATION/DROP WITH OUR ONLINE CALCULATOR: <https://en.globtek.com/output-cable-regulation-calculator/>

<p>GlobTek, Inc. www.globtek.com 186 Veterans Drive, Northvale, NJ 07647 Tel. (201) 784-1000 Fax (201) 784-0111</p>	<p>Drawing Title: GTM93021-2024-P2, ICT / ITE / Medical Power Supply/Class 2/Household Power Supply, Efficiency Level: V, Case Color/Style: GlobTek Black, Potted/Encapsulated in plastic housing, Regulated Switchmode AC-DC Power Supply AC Adaptor, Input Rating: 100-240V~, 50-60 Hz, Lead Wires , Output Rating: 20W, 24.0V@0.83A, Output Configuration: 240 mm, 18/1C + Shield Cond, UL 1185, Stripped 20 +2/-2mm; Tinned 6 +/-1mm or Equal, Ferrite: None, GlobTek Black, GT Cord # C2121, Pin Out: White Conductor (+V), Shield (-V), Blades/Input Cord: 200mm, 2* 18 AWG 1 conductor, UL 1015, solid, Black & White, Approvals: EAC; UKCA; Ukraine; China RoHS; WEEE; Double Insulation; PSE; Fuse 60335; CB EN/IEC 60335-1; CE; NEMKO EN/IEC 60335-1; RoHS; VCCI; cETLus UL1310; IP68; UL 1310; UL 1310; Fuse 60335; 61558-1; IEC 61558-1;</p>
	<p>Model No. GTM93021-2024-P2</p>
	<p>Part No./Ordering No. PR9SI830A00CHM(RVB) Rev C</p>

OUTPUT CONNECTOR HOOK UP

TO ADDRESS SYSTEM-LEVEL EMI CONCERNS, FERRITE CHOKES/BEADS MAY BE ADDED/REVISED UPON REQUEST. A SAMPLE KIT OF GLOBTEK'S STANDARD FERRITES IS AVAILABLE UNDER GLOBTEK P/N: EMI-MITIGATION-KIT1

FOR ADDITIONAL INFORMATION, PLEASE READ OUR WHITE PAPER AT:

<https://en.globtek.com/technical-articles/ferrite-kit-radiated-emi-suppression-kit-for-globtek-power-supplies-cable-assemblies>

GloTek, Inc. www.globtek.com 186 Veterans Drive, Northvale, NJ 07647 Tel. (201) 784-1000 Fax (201) 784-0111	Drawing Title: GTM93021-2024-P2, ICT / ITE / Medical Power Supply/Class 2/Household Power Supply, Efficiency Level: V, Case Color/Style: GlobTek Black, Potted/Encapsulated in plastic housing, Regulated Switchmode AC-DC Power Supply AC Adaptor, Input Rating: 100-240V~, 50-60 Hz, Lead Wires , Output Rating: 20W, 24.0V@0.83A, Output Configuration: 240 mm, 18/1C + Shield Cond, UL 1185, Stripped 20 +2/-2mm; Tinned 6 +/-1mm or Equal, Ferrite: None, GlobTek Black, GT Cord # C2121, Pin Out: White Conductor (+V), Shield (-V), Blades/Input Cord: 200mm, 2* 18 AWG 1 conductor, UL 1015, solid, Black & White, Approvals: EAC; UKCA; Ukraine; China RoHS; WEEE; Double Insulation; PSE; Fuse 60335; CB EN/IEC 60335-1; CE; NEMKO EN/IEC 60335-1; RoHS; VCCI; cETLus UL1310; IP68; UL 1310; UL 1310; Fuse 60335; 61558-1; IEC 61558-1;	
	Model No. GTM93021-2024-P2	
	Part No./Ordering No. PR9SI830A00CHM(RVB)	Rev C

LABEL:L-1186

LABEL P/N	Standard GT
MATERIAL	Flat Thermal Transfer, Imprintable, Polyester Label and/or Pad Printed and/or Molded, and/or Laser Engraved in the case
BACKGROUND COLOR	Black if housing is Black, White or Silver if housing is White or Gray.
TEXT COLOR	White or Silver if label is Black Background for Black housing. Black if label is White or Silver background and Housing is White or Gray.
LABEL WIDTH (mm)	39.5
LABEL HEIGHT (mm)	36.5
SPECIAL BARCODE LABEL MATERIAL	No

Below is the minimum information which will appear on the label. NOTE: in the logo area additional/actual positioning of symbols and text is subjected to change as per agency updates/requirements or additional model approvals become available.
Regulatory certifications/label markings may be in logo area on the label or molded into the case housing outside the label area.
Information will be shown via label and/or pad printed and/or molded and/or laser engraved in the case. * Date code markings at GlobTek option

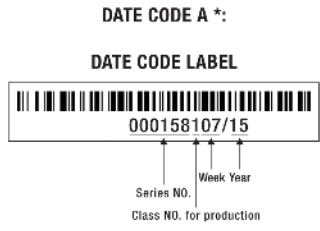

or
DATE CODE B *:
WWYY
WW = WEEK
YY = YEAR

A=ICT / ITE / Medical Power Supply/Class 2/Household Power Supply
B=P/N: (料号) PR9SI830A00CHM(RVB)
C=Model (型号) GTM93021-2024-P2
D=Input (输入)100-240V~, 50-60 Hz, 0.6 A Max
E=Output (输出)24.0 V 0.83 A, 20.00W

GlobTek, Inc. www.globtek.com 186 Veterans Drive, Northvale, NJ 07647 Tel. (201) 784-1000 Fax (201) 784-0111	Drawing Title: GTM93021-2024-P2, ICT / ITE / Medical Power Supply/Class 2/Household Power Supply, Efficiency Level: V, Case Color/Style: GlobTek Black, Potted/Encapsulated in plastic housing, Regulated Switchmode AC-DC Power Supply AC Adaptor, Input Rating: 100-240V~, 50-60 Hz, Lead Wires , Output Rating: 20W, 24.0V@0.83A, Output Configuration: 240 mm, 18/1C + Shield Cond, UL 1185, Stripped 20 +2/-2mm; Tinned 6 +/-1mm or Equal, Ferrite: None, GlobTek Black, GT Cord # C2121, Pin Out: White Conductor (+V), Shield (-V), Blades/Input Cord: 200mm, 2* 18 AWG 1 conductor, UL 1015, solid, Black & White, Approvals: EAC; UKCA; Ukraine; China RoHS; WEEE; Double Insulation; PSE; Fuse 60335; CB EN/IEC 60335-1; CE; NEMKO EN/IEC 60335-1; RoHS; VCCI; cETLus UL1310; IP68; UL 1310; UL 1310; Fuse 60335; 61558-1; IEC 61558-1;	
	Model No. GTM93021-2024-P2	
	Part No./Ordering No. PR9SI830A00CHM(RVB)	Rev C

AGENCY ONLINE DOCUMENTS	http://globtek.info/certs/GTM93021
CE EC-Declaration for Medical	Contact GlobTek for more information
CE EC-Declaration for Industrial/Commercial/ITE	http://globtek.force.com/models/ec_declaration_product?id=01ta0000005d3uH&i=4
CE EC-Declaration for Household	http://globtek.force.com/models/ec_declaration_product?id=01ta0000005d3uH&h=3
UKCA-Declaration for Medical	Contact GlobTek for more information
UKCA-Declaration for Industrial/Commercial/ITE	http://globtek.force.com/models/ukca_declaration_product?id=01ta0000005d3uH&i=4
UKCA-Declaration for Household	http://globtek.force.com/models/ukca_declaration_product?id=01ta0000005d3uH&h=3
Morocco SDoC Declaration	https://globtek.secure.force.com/models/Morocco_SDoC_Declaration?id=a0Oa000000C2dRKEAZ
RoHS/RoHS3 Declaration	https://www.globtek.com/pdf/rohs_cert/01ta0000005d3uHAAQ
REACH Declaration	https://www.globtek.com/pdf/iso_certificates/REACH.pdf
Conflict Minerals Declaration	https://www.globtek.com/pdf/conflict-minerals.pdf
Prop 65 Statement	https://en.globtek.com/prop-65-statement.pdf
IPXY rating is based on 3rd party testing and customers should check suitability and test system level IPXY rating before ordering.	

Regulatory Certifications/Label Markings

Below follows a link to the latest regulatory certifications and marks for this specific product. National standards as well as certification schemes are constantly changing and so is the set of certification marks and symbols applicable to this product. Various standards, marks and symbols, and certificates are subject to change at any time without notice.

Additional standards or unique country certifications are available upon request. Please contact Globtek to request a quotation.

LATEST PRODUCT/MODEL CERTIFICATIONS:	https://www.globtek.com/datasheet/w70769
AGENCY ONLINE DOCUMENTS	http://globtek.info/certs/GTM93021

	(F1) Class II / Double Insulated
	White Conductor (+V), Shield (-V)

GlobTek, Inc. www.globtek.com 186 Veterans Drive, Northvale, NJ 07647 Tel. (201) 784-1000 Fax (201) 784-0111	Drawing Title: GTM93021-2024-P2, ICT / ITE / Medical Power Supply/Class 2/Household Power Supply, Efficiency Level: V, Case Color/Style: GlobTek Black, Potted/Encapsulated in plastic housing, Regulated Switchmode AC-DC Power Supply AC Adaptor, Input Rating: 100-240V~, 50-60 Hz, Lead Wires , Output Rating: 20W, 24.0V@0.83A, Output Configuration: 240 mm, 18/1C + Shield Cond, UL 1185, Stripped 20 +/-2mm; Tinned 6 +/-1mm or Equal, Ferrite: None, GlobTek Black, GT Cord # C2121, Pin Out: White Conductor (+V), Shield (-V), Blades/Input Cord: 200mm, 2* 18 AWG 1 conductor, UL 1015, solid, Black & White, Approvals: EAC; UKCA; Ukraine; China RoHS; WEEE; Double Insulation; PSE; Fuse 60335; CB EN/IEC 60335-1; CE; NEMKO EN/IEC 60335-1; RoHS; VCCI; cETLus UL1310; IP68; UL 1310; UL 1310; Fuse 60335; 61558-1; IEC 61558-1;	
	Model No. GTM93021-2024-P2	
	Part No./Ordering No. PR9SI830A00CHM(RVB)	Rev C

PACKAGING

Packing Spec P/N	Standard Potted, Individually Box.gif
Box Qty	144
Gift Box Size (mm)	55*51*60
Gift Box Color	White
Master Carton Size (mm)	380 x 380 x 250
Master Carton Cubic Volume (m³)	0.04
Master GW (Kg)	15.6 kg
BLADES INCLUDED	FC-Lead Wire 200: 200mm, 2* 18 AWG 1 conductor, UL 1015, solid, Black & White
BLADE/CORD INSTALLED	FC-Lead Wire 200: 200mm, 2* 18 AWG 1 conductor, UL 1015, solid, Black & White
USER MANUAL*	
USER MANUAL WEB LINK	

* This specification sheet is considered the user manual for all applications. It is expected that the buyer of this product will use it to formulate their own user manual for their end product and a user manual specifically for the power adapter is not usually required. If a user manual is not specifically listed above then none will be provided with this unit.

If specific packaging is required, this section must specify all requirements and note "no exceptions". If this section does not specify packaging, it is subject to change without notice at GlobTek's discretion

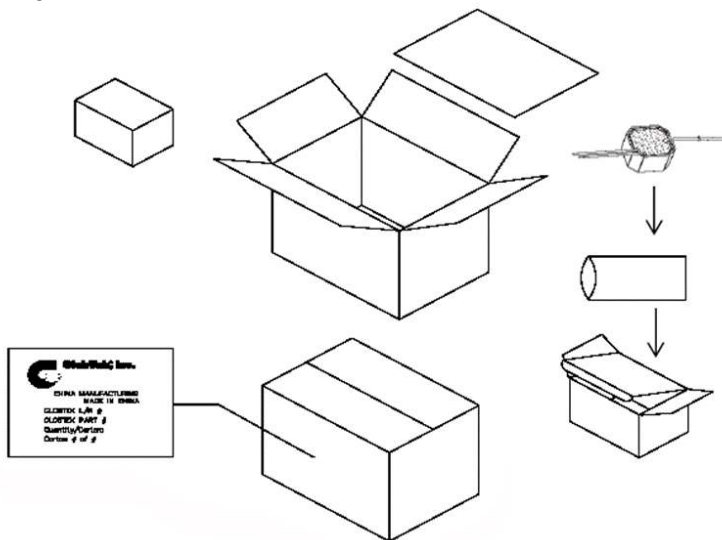

<p>GlobTek, Inc. www.globtek.com 186 Veterans Drive, Northvale, NJ 07647 Tel. (201) 784-1000 Fax (201) 784-0111</p>	<p>Drawing Title: GTM93021-2024-P2, ICT / ITE / Medical Power Supply/Class 2/Household Power Supply, Efficiency Level: V, Case Color/Style: GlobTek Black, Potted/Encapsulated in plastic housing, Regulated Switchmode AC-DC Power Supply AC Adaptor, Input Rating: 100-240V~, 50-60 Hz, Lead Wires , Output Rating: 20W, 24.0V@0.83A, Output Configuration: 240 mm, 18/1C + Shield Cond, UL 1185, Stripped 20 +2/-2mm; Tinned 6 +/-1mm or Equal, Ferrite: None, GlobTek Black, GT Cord # C2121, Pin Out: White Conductor (+V), Shield (-V), Blades/Input Cord: 200mm, 2* 18 AWG 1 conductor, UL 1015, solid, Black & White, Approvals: EAC; UKCA; Ukraine; China RoHS; WEEE; Double Insulation; PSE; Fuse 60335; CB EN/IEC 60335-1; CE; NEMKO EN/IEC 60335-1; RoHS; VCCI; cETLus UL1310; IP68; UL 1310; UL 1310; Fuse 60335; 61558-1; IEC 61558-1;</p>
	<p>Model No. GTM93021-2024-P2</p>
	<p>Part No./Ordering No. PR9SI830A00CHM(RVB) Rev C</p>

INSTRUCTIONS TO THE OEM SYSTEMS ENGINEER

It is the responsibility of the OEM systems engineer to provide the end system user instructions and warnings for the use of this product in the end system.

If an input cord is required for this product, AC Mains voltage should be provided to the power supply by a power supply cord approved to the national standards of the country in which it will be used.

This product is not designed to be repaired. No serviceable parts inside. A blown internal fuse is an indication of catastrophic failure of circuit component(s). If a Failure Analysis is required for a failed power supply/battery charger, please return the damaged unit to GlobTek for an accurate determination of the root cause of the failure.

EMC Compliance of the complete OEM product, including the GlobTek power supply/battery charger needs to be verified by the OEM systems engineer.

INSTRUCTION SHEET

<p>GlobTek, Inc. www.globtek.com 186 Veterans Drive, Northvale, NJ 07647 Tel. (201) 784-1000 Fax (201) 784-0111</p>	<p>Drawing Title: GTM93021-2024-P2, ICT / ITE / Medical Power Supply/Class 2/Household Power Supply, Efficiency Level: V, Case Color/Style: GlobTek Black, Potted/Encapsulated in plastic housing, Regulated Switchmode AC-DC Power Supply AC Adaptor, Input Rating: 100-240V~, 50-60 Hz, Lead Wires , Output Rating: 20W, 24.0V@0.83A, Output Configuration: 240 mm, 18/1C + Shield Cond, UL 1185, Stripped 20 +/-2mm; Tinned 6 +/-1mm or Equal, Ferrite: None, GlobTek Black, GT Cord # C2121, Pin Out: White Conductor (+V), Shield (-V), Blades/Input Cord: 200mm, 2* 18 AWG 1 conductor, UL 1015, solid, Black & White, Approvals: EAC; UKCA; Ukraine; China RoHS; WEEE; Double Insulation; PSE; Fuse 60335; CB EN/IEC 60335-1; CE; NEMKO EN/IEC 60335-1; RoHS; VCCI; cETLus UL1310; IP68; UL 1310; UL 1310; Fuse 60335; 61558-1; IEC 61558-1;</p>
	<p>Model No. GTM93021-2024-P2</p>
	<p>Part No./Ordering No. PR9SI830A00CHM(RVB) Rev C</p>

