

<b>PROPRIETARY INFORMATION:</b> PROPRIETARY OF GLOBTEK, INC. ANY REPRODUCTION, DISCLOSURE OR USE OF THIS DRAWING, IN WHOLE OR IN PART, IS HEREBY PROHIBITED EXCEPT AS SPECIFIED IN WRITING BY GLOBTEK, INC.	REVISION			
	REV	DESCRIPTION	DATE	APPROVED
	A	INITIAL RELEASE, RFS. 20847, JS	05/02/11	HM

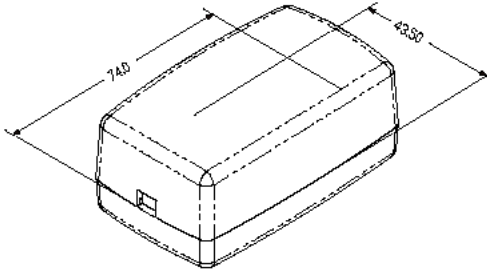

STANDARD OPTION SHIPS WITHOUT AC PINS INSTALLED

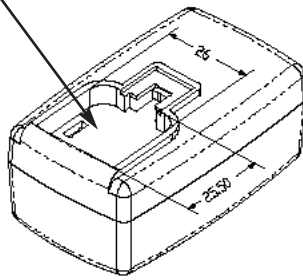

**1. MATERIAL**

HIGH IMPACT PLASTIC, 94V0 POLYCARBONATE, NON-VENTED, COLOR GLOBTEK WHITE 057

**2. INPUT CONNECTOR:**

EUROPEAN CONFIGURATION CEE 7/16: EUROPLUG 2 PINS, CLASS II

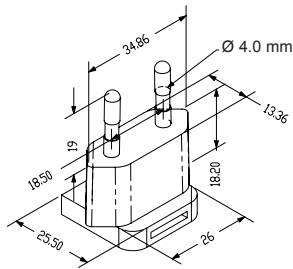

P/N: Q-EU-WH(R)  
 EUROPE  
 SOUTH AMERICA

**RELEASED**  
 By N.Frost at 1:18 pm, Jul 07, 2016

Foot Note: Globtek Inc. will not be liable for the safety and performance of these power supplies if unauthorized access and repair occurs. End user should consult applicable UL, CSA or EN standards for proper installation instructions	DASH NO.	PART NO	REV.	DESCRIPTION	NOTES
	<b>TABULATION BLOCK</b>				
Limitation of Use: Globtek product are not authorized for use as mission critical components in life support, hazardous environment, nuclear or aircraft applications without prior written approval from the CEO of Globtek Inc.	INIT.BY: JS		DATE: 05/02/11	<b>TOLERANCES:</b> DECIMALS    ANGULAR .xx +/- 0.1    +/- 1' .xxx +/- .005	<b>GlobTek, Inc.</b> 186 Veterans Dr. Northvale, NJ 07647 www.globtek.com Tel. 201-784-1000 Fax 201.784.0111
	DRAWN: NF	DATE: 05/02/11	FSCN No.: G, N		
	APRVD : HM	DATE: 05/02/11	SCALE: NONE	MODEL NO: N/A	REV. A
				PART NO: Q-EU-WH(R)	SHEET 1 OF 4

**PROPRIETARY INFORMATION:**  
 PROPRIETARY OF GLOBTEK, INC. ANY REPRODUCTION, DISCLOSURE OR  
 USE OF THIS DRAWING, IN WHOLE OR IN PART, IS HEREBY  
 PROHIBITED EXCEPT AS SPECIFIED IN WRITING BY GLOBTEK, INC.

**3. PACKING:**

CARTON SIZE: 485 x 483 x 329  
 Q'TY: 900 pcs (150 x 6)

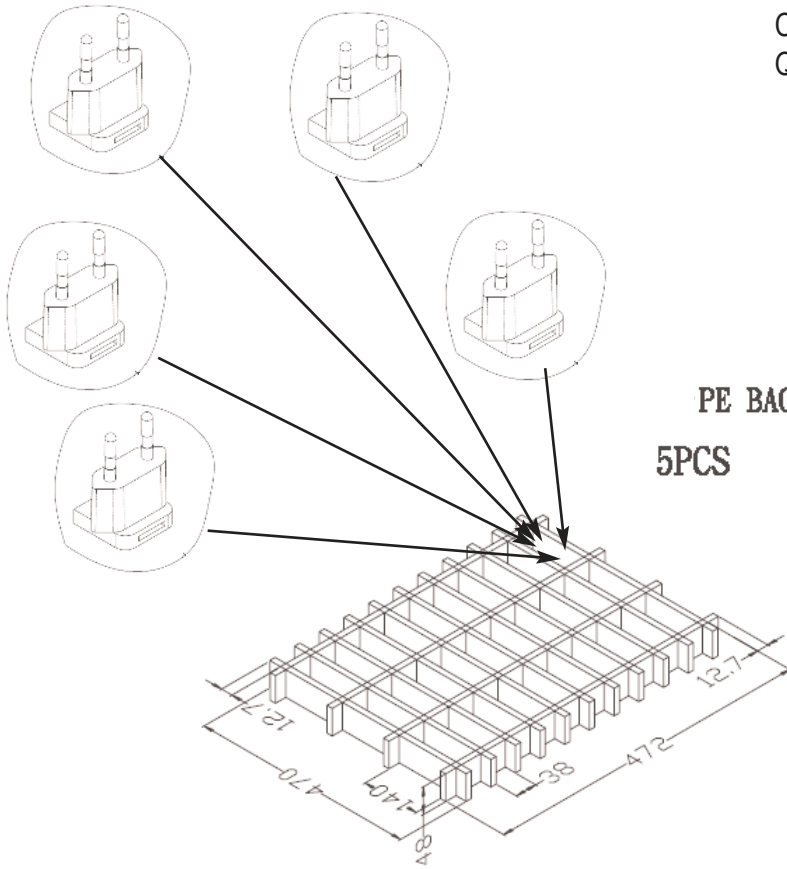

PE BAG(SIZE:80X200)  
 5PCS

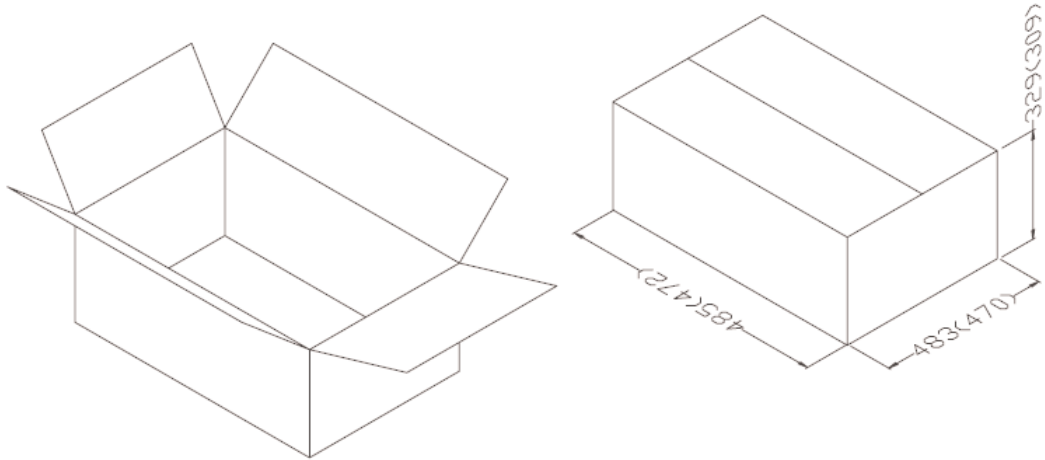

 <b>GlobTek, Inc.</b> <a href="http://www.globtek.com">www.globtek.com</a>		186 Veterans Dr. Northvale, NJ 07647 Tel. 201-784-1000 Fax 201.784.0111
DWG TITLE: EUROPE INTERCHANGEABLE INPUT BLADES		
MODEL NO: N/A		REV. A
PART NO: Q-EU-WH(R)		SHEET 2 OF 4

**PROPRIETARY INFORMATION:**  
 PROPRIETARY OF GLOBTEK, INC. ANY REPRODUCTION, DISCLOSURE OR  
 USE OF THIS DRAWING, IN WHOLE OR IN PART, IS HEREBY  
 PROHIBITED EXCEPT AS SPECIFIED IN WRITING BY GLOBTEK, INC.

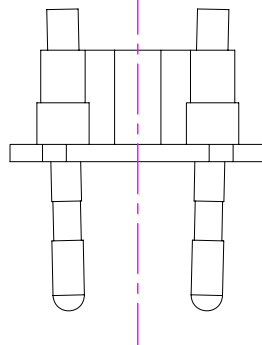
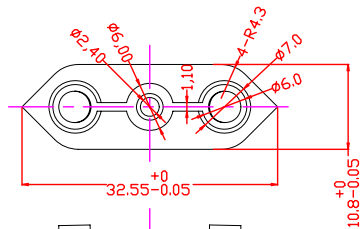
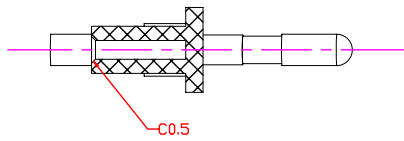
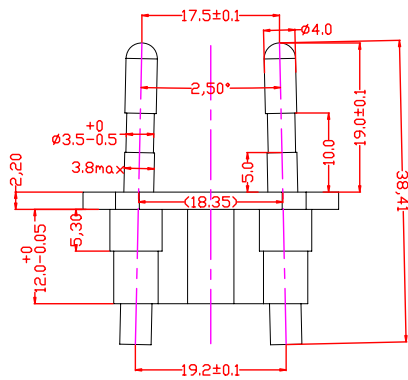
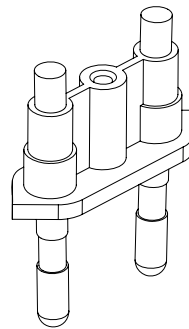
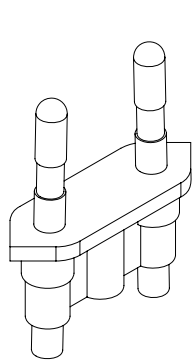

 <b>GlobTek, Inc.</b> www.globtek.com		186 Veterans Dr. Northvale, NJ 07647 Tel. 201-784-1000 Fax 201.784.0111	
DWG TITLE: EUROPE INTERCHANGEABLE INPUT BLADES			
MODEL NO: N/A			REV. A
PART NO: Q-EU-WH(R)			SHEET 3 OF 4

