

ATS/ATS-SM Series Quartz Crystal

Features

- Standard HC-49/US & HC-49/US-SM Metal Packages
- Fundamental and 3rd Overtone Crystal Design
- Frequency Range 3.2 – 64MHz
- Frequency Tolerance, ± 30 ppm Standard
- Frequency Stability, ± 50 ppm Standard
- Operating Temperature Range -20°C to $+70^{\circ}\text{C}$ or -40°C to $+85^{\circ}\text{C}$
- Tape and Reel Packaging, EIA-481



Part Dimensions:
 ATS – 10.85 × 4.5 × 3.66mm • 562.81mg
 ATS-SM – 11.1 × 4.83 × 4.3mm • 587.84mg

Applications

- Wireless Communications
- Broadband Access
- FPGA/Microcontrollers
- Computer Peripherals
- Microprocessors
- Test and Measurement
- Consumer Electronics
- Portable Equipment

Description

CTS ATS and ATS-SM incorporates a high Q quartz resonator in a proven resistance-weld metal package. They are ideal for supporting a wide range of commercial and industrial applications.

Ordering Information

ATS				
Model	Frequency/Load Code	Packaging	Temperature Range	Product Options
ATS	XXX or XXXX	-		
	Code Frequency		Code Temp. Range	
	Frequency/Load Code ¹		Blank -20°C to $+70^{\circ}\text{C}$	
			E -40°C to $+85^{\circ}\text{C}$	
		Code Packing		Code Option
		Blank Bulk ²		Blank No Option
		1 Radial Taping		INS Insulation Spacer

Notes:

- 1) Refer to Standard Product Part Numbers tables on Page 2 and 3.
- 2) Standard packaging is bulk in a bag.

ATS-SM				
Model	Frequency/Load Code	Packaging	Temperature Range	
ATS	XXX or XXXX	SM-	1	
	Code Frequency			Code Temp. Range
	Frequency/Load Code ¹			Blank -20°C to $+70^{\circ}\text{C}$
				E -40°C to $+85^{\circ}\text{C}$
		Code Packing		
		Blank Bulk		
		1 Tape & Reel ²		

Notes:

- 1) Refer to Standard Product Part Numbers tables on Page 3 and 4.
- 2) Standard packaging is tape and reel.
CTS Distributors may use -T for tape and reel indicator.
- 3) For tighter stabilities or frequencies not shown in Page 3 and 4 tables, use ATSSMTS data sheet to build CTS part number.

**Not all performance combinations and frequencies may be available.
 Contact your local CTS Representative or CTS Customer Service for availability.**

This product is specified for use only in standard commercial applications. Supplier disclaims all express and implied warranties and liability in connection with any use of this product in any non-commercial applications or in any application that may expose the product to conditions that are outside of the tolerances provided in its specification.



ATS – Standard Product Part Numbers

Part numbers in **BOLD** are commonly stock items through CTS authorized distributors. Non-bold numbers may be stocked or are available for order.

FREQUENCY [MHz]	PART NUMBER [-20°C/+70°C]	PART NUMBER [-40°C/+85°C]	LOAD CAPACITANCE	OPERATING MODE	FREQUENCY [MHz]	PART NUMBER [-20°C/+70°C]	PART NUMBER [-40°C/+85°C]	LOAD CAPACITANCE	OPERATING MODE
3.579545	ATS036B	ATS036B-E	Series	Fundamental	12.000000	ATS120	ATS120-E	Series	Fundamental
3.579545	ATS036	ATS036-E	18pF	Fundamental	12.000000	ATS12A	ATS12A-E	20pF	Fundamental
3.686400	ATS037A	ATS037A-E	Series	Fundamental	12.000000	ATS120B	ATS120B-E	18pF	Fundamental
3.686400	ATS037	ATS037-E	20pF	Fundamental	12.000000	ATS120C	ATS120C-E	32pF	Fundamental
3.686400	ATS037B	ATS037B-E	18pF	Fundamental	12.288000	ATS125	ATS125-E	Series	Fundamental
4.000000	ATS04A	ATS04A-E	Series	Fundamental	12.288000	ATS122	ATS122-E	20pF	Fundamental
4.000000	ATS040	ATS040-E	20pF	Fundamental	12.288000	ATS122B	ATS122B-E	18pF	Fundamental
4.000000	ATS040B	ATS040B-E	18pF	Fundamental	12.296000	ATS124	ATS124-E	Series	Fundamental
4.096000	ATS042A	ATS042A-E	20pF	Fundamental	12.296000	ATS123	ATS123-E	20pF	Fundamental
4.096000	ATS042B	ATS042B-E	18pF	Fundamental	12.296000	ATS123B	ATS123B-E	18pF	Fundamental
4.194304	ATS041C	ATS041C-E	12pF	Fundamental	12.352000	ATS126	ATS126-E	Series	Fundamental
4.915200	ATS049A	ATS049A-E	Series	Fundamental	12.352000	ATS127	ATS127-E	20pF	Fundamental
4.915200	ATS042	ATS042-E	20pF	Fundamental	13.500000	ATS135	ATS135-E	20pF	Fundamental
4.915200	ATS049B	ATS049B-E	18pF	Fundamental	13.560000	ATS13CA	ATS13CA-E	20pF	Fundamental
5.000000	ATS050C	ATS050C-E	Series	Fundamental	14.318180	ATS143	ATS143-E	Series	Fundamental
5.000000	ATS050A	ATS050A-E	20pF	Fundamental	14.318180	ATS14A	ATS14A-E	20pF	Fundamental
5.000000	ATS050B	ATS050B-E	18pF	Fundamental	14.318180	ATS143B	ATS143B-E	18pF	Fundamental
5.068800	ATS051	ATS051-E	Series	Fundamental	14.745600	ATS147	ATS147-E	Series	Fundamental
5.068800	ATS050	ATS050-E	20pF	Fundamental	14.745600	ATS147A	ATS147A-E	20pF	Fundamental
6.000000	ATS060A	ATS060A-E	Series	Fundamental	14.745600	ATS147B	ATS147B-E	18pF	Fundamental
6.000000	ATS060	ATS060-E	20pF	Fundamental	15.000000	ATS150	ATS150-E	Series	Fundamental
6.000000	ATS060B	ATS060B-E	18pF	Fundamental	15.360000	ATS15A	ATS15A-E	20pF	Fundamental
6.000000	ATS060C	ATS060C-E	32pF	Fundamental	16.000000	ATS160	ATS160-E	Series	Fundamental
6.144000	ATS061	ATS061-E	20pF	Fundamental	16.000000	ATS16A	ATS16A-E	20pF	Fundamental
6.144000	ATS061B	ATS061B-E	18pF	Fundamental	16.000000	ATS16B	ATS16B-E	18pF	Fundamental
6.144000	ATS061C	ATS061C-E	32pF	Fundamental	16.384000	ATS164B	ATS164B-E	18pF	Fundamental
7.372800	ATS073A	ATS073A-E	Series	Fundamental	16.934400	ATS169	ATS169-E	20pF	Fundamental
7.372800	ATS073	ATS073-E	20pF	Fundamental	18.000000	ATS180A	ATS180A-E	20pF	Fundamental
7.372800	ATS073B	ATS073B-E	18pF	Fundamental	18.432000	ATS184	ATS184-E	Series	Fundamental
7.500000	ATS075	ATS075-E	Series	Fundamental	18.432000	ATS18A	ATS18A-E	20pF	Fundamental
7.500000	ATS075A	ATS075A-E	20pF	Fundamental	18.432000	ATS184B	ATS184B-E	18pF	Fundamental
7.500000	ATS075B	ATS075B-E	18pF	Fundamental	19.660800	ATS196	ATS196-E	Series	Fundamental
8.000000	ATS080	ATS080-E	Series	Fundamental	19.660800	ATS19A	ATS19A-E	20pF	Fundamental
8.000000	ATS08A	ATS08A-E	20pF	Fundamental	19.660800	ATS196B	ATS196B-E	18pF	Fundamental
8.000000	ATS080B	ATS080B-E	18pF	Fundamental	20.000000	ATS200	ATS200-E	Series	Fundamental
8.000000	ATS080C	ATS080C-E	32pF	Fundamental	20.000000	ATS20A	ATS20A-E	20pF	Fundamental
8.192000	ATS081B	ATS081B-E	18pF	Fundamental	20.000000	ATS200C	ATS200C-E	18pF	Fundamental
9.830400	ATS099	ATS099-E	Series	Fundamental	20.000000	ATS20B	ATS20B-E	50pF	Fundamental
9.830400	ATS098	ATS098-E	20pF	Fundamental	20.480000	ATS204	ATS204-E	20pF	Fundamental
9.830400	ATS098B	ATS098B-E	18pF	Fundamental	22.118400	ATS22A	ATS22A-E	20pF	Fundamental
10.000000	ATS100	ATS100-E	Series	Fundamental	22.118400	ATS221B	ATS221B-E	18pF	Fundamental
10.000000	ATS10A	ATS10A-E	20pF	Fundamental	24.000000	ATS240	ATS240-E	Series	Fundamental
10.000000	ATS100B	ATS100B-E	18pF	Fundamental	24.000000	ATS24A	ATS24A-E	20pF	Fundamental
11.059200	ATS111A	ATS111A-E	Series	Fundamental	24.000000	ATS240B	ATS240B-E	18pF	Fundamental
11.059200	ATS111	ATS111-E	20pF	Fundamental	24.000000	ATS240C	ATS240C-E	12pF	Fundamental
11.059200	ATS111B	ATS111B-E	18pF	Fundamental					
11.059200	ATS111C	ATS111C-E	32pF	Fundamental					



ATS – Standard Product Part Numbers Continued

Part numbers in **BOLD** are commonly stock items through CTS authorized distributors. Non-bold numbers may be stocked or are available for order.

FREQUENCY [MHz]	PART NUMBER [-20°C/+70°C]	PART NUMBER [-40°C/+85°C]	LOAD CAPACITANCE	OPERATING MODE
24.576000	ATS245	ATS245-E	Series	Fundamental
24.576000	ATS24B	ATS24B-E	20pF	Fundamental
24.576000	ATS245A	ATS245A-E	18pF	Fundamental
25.000000	ATS250	ATS250-E	Series	Fundamental
25.000000	ATS25A	ATS25A-E	20pF	Fundamental
25.000000	ATS250B	ATS250B-E	18pF	Fundamental
27.000000	ATS270A	ATS270A-E	20pF	Fundamental
27.000000	ATS270B	ATS270B-E	18pF	Fundamental
30.000000	ATS300B	ATS300B-E	18pF	3rd Overtone
32.000000	ATS320	ATS320-E	Series	3rd Overtone
32.000000	ATS32A	ATS32A-E	20pF	3rd Overtone
32.000000	ATS320B	ATS320B-E	18pF	3rd Overtone

FREQUENCY [MHz]	PART NUMBER [-20°C/+70°C]	PART NUMBER [-40°C/+85°C]	LOAD CAPACITANCE	OPERATING MODE
40.000000	ATS400	ATS400-E	Series	3rd Overtone
40.000000	ATS40A	ATS40A-E	20pF	3rd Overtone
40.000000	ATS400B	ATS400B-E	18pF	3rd Overtone
48.000000	ATS480A	ATS480A-E	20pF	3rd Overtone
48.000000	ATS480B	ATS480B-E	18pF	3rd Overtone
60.000000	ATS600A	ATS600A-E	20pF	3rd Overtone
60.000000	ATS600B	ATS600B-E	18pF	3rd Overtone
64.000000	ATS640A	ATS640A-E	20pF	3rd Overtone
64.000000	ATS640B	ATS640B-E	18pF	3rd Overtone

ATS-SM – Standard Product Part Numbers

Part numbers in **BOLD** are commonly stock items through CTS authorized distributors. Non-bold numbers may be stocked or are available for order.

For tighter stabilities, additional load options or frequencies not shown in table; use ATSSMTS data sheet to order.

FREQUENCY [MHz]	PART NUMBER [-20°C/+70°C]	PART NUMBER [-40°C/+85°C]	LOAD CAPACITANCE	OPERATING MODE
3.579545	ATS036BSM-1	ATS036BSM-1E	Series	Fundamental
3.579545	ATS036SM-1	ATS036SM-1E	18pF	Fundamental
3.686400	ATS037ASM-1	ATS037ASM-1E	Series	Fundamental
3.686400	ATS037SM-1	ATS037SM-1E	20pF	Fundamental
3.686400	ATS037BSM-1	ATS037BSM-1E	18pF	Fundamental
4.000000	ATS04ASM-1	ATS04ASM-1E	Series	Fundamental
4.000000	ATS040SM-1	ATS040SM-1E	20pF	Fundamental
4.000000	ATS040BSM-1	ATS040BSM-1E	18pF	Fundamental
4.096000	ATS042ASM-1	ATS042ASM-1E	20pF	Fundamental
4.096000	ATS042BSM-1	ATS042BSM-1E	18pF	Fundamental
4.194304	ATS041BSM-1	ATS041BSM-1E	18pF	Fundamental
4.194304	ATS041CSM-1	ATS041CSM-1E	12pF	Fundamental
4.915200	ATS049ASM-1	ATS049ASM-1E	Series	Fundamental
4.915200	ATS042SM-1	ATS042SM-1E	20pF	Fundamental
4.915200	ATS049BSM-1	ATS049BSM-1E	18pF	Fundamental
5.000000	ATS050CSM-1	ATS050CSM-1E	Series	Fundamental
5.000000	ATS050ASM-1	ATS050ASM-1E	20pF	Fundamental
5.000000	ATS050BSM-1	ATS050BSM-1E	18pF	Fundamental
5.068800	ATS051SM-1	ATS051SM-1E	Series	Fundamental
5.068800	ATS050SM-1	ATS050SM-1E	20pF	Fundamental
6.000000	ATS060ASM-1	ATS060ASM-1E	Series	Fundamental
6.000000	ATS060SM-1	ATS060SM-1E	20pF	Fundamental
6.000000	ATS060BSM-1	ATS060BSM-1E	18pF	Fundamental
6.000000	ATS060CSM-1	ATS060CSM-1E	32pF	Fundamental
6.144000	ATS061SM-1	ATS061SM-1E	20pF	Fundamental
6.144000	ATS061BSM-1	ATS061BSM-1E	18pF	Fundamental
6.144000	ATS061CSM-1	ATS061CSM-1E	32pF	Fundamental

FREQUENCY [MHz]	PART NUMBER [-20°C/+70°C]	PART NUMBER [-40°C/+85°C]	LOAD CAPACITANCE	OPERATING MODE
7.372800	ATS073ASM-1	ATS073ASM-1E	Series	Fundamental
7.372800	ATS073SM-1	ATS073SM-1E	20pF	Fundamental
7.372800	ATS073BSM-1	ATS073BSM-1E	18pF	Fundamental
8.000000	ATS080SM-1	ATS080SM-1E	Series	Fundamental
8.000000	ATS08ASM-1	ATS08ASM-1E	20pF	Fundamental
8.000000	ATS080BSM-1	ATS080BSM-1E	18pF	Fundamental
8.000000	ATS080CSM-1	ATS080CSM-1E	32pF	Fundamental
8.192000	ATS081BSM-1	ATS081BSM-1E	18pF	Fundamental
9.830400	ATS099SM-1	ATS099SM-1E	Series	Fundamental
9.830400	ATS098SM-1	ATS098SM-1E	20pF	Fundamental
9.830400	ATS098BSM-1	ATS098BSM-1E	18pF	Fundamental
10.000000	ATS100SM-1	ATS100SM-1E	Series	Fundamental
10.000000	ATS10ASM-1	ATS10ASM-1E	20pF	Fundamental
10.000000	ATS100BSM-1	ATS100BSM-1E	18pF	Fundamental
11.059200	ATS111ASM-1	ATS111ASM-1E	Series	Fundamental
11.059200	ATS111SM-1	ATS111SM-1E	20pF	Fundamental
11.059200	ATS111BSM-1	ATS111BSM-1E	18pF	Fundamental
11.059200	ATS111CSM-1	ATS111CSM-1E	32pF	Fundamental
12.000000	ATS120SM-1	ATS120SM-1E	Series	Fundamental
12.000000	ATS12ASM-1	ATS12ASM-1E	20pF	Fundamental
12.000000	ATS120BSM-1	ATS120BSM-1E	18pF	Fundamental
12.000000	ATS120CSM-1	ATS120CSM-1E	32pF	Fundamental
12.288000	ATS125SM-1	ATS125SM-1E	Series	Fundamental
12.288000	ATS122SM-1	ATS122SM-1E	20pF	Fundamental
12.288000	ATS122BSM-1	ATS122BSM-1E	18pF	Fundamental
12.296000	ATS123SM-1	ATS123SM-1E	Series	Fundamental
12.296000	ATS124SM-1	ATS124SM-1E	20pF	Fundamental



ATS-SM – Standard Product Part Numbers Continued

Part numbers in **BOLD** are commonly stock items through CTS authorized distributors. Non-bold numbers may be stocked or are available for order.

For tighter stabilities, additional load options or frequencies not shown in table; use ATSSMTS data sheet to order.

FREQUENCY [MHz]	PART NUMBER [-20°C/+70°C]	PART NUMBER [-40°C/+85°C]	LOAD CAPACITANCE	OPERATING MODE	FREQUENCY [MHz]	PART NUMBER [-20°C/+70°C]	PART NUMBER [-40°C/+85°C]	LOAD CAPACITANCE	OPERATING MODE
12.352000	ATS127SM-1	ATS127SM-1E	Series	Fundamental	22.579200	ATS225BSM-1	ATS225BSM-1E	18pF	Fundamental
12.352000	ATS126SM-1	ATS126SM-1E	20pF	Fundamental	24.000000	ATS240SM-1	ATS240SM-1E	Series	Fundamental
12.500000	ATS125BSM-1	ATS125BSM-1E	18pF	Fundamental	24.000000	ATS24ASM-1	ATS24ASM-1E	20pF	Fundamental
13.000000	ATS130SM-1	ATS130SM-1E	20pF	Fundamental	24.000000	ATS240BSM-1	ATS240BSM-1E	18pF	Fundamental
13.500000	ATS135SM-1	ATS135SM-1E	20pF	Fundamental	24.000000	ATS240CSM-1	ATS240CSM-1E	12pF	Fundamental
13.500000	ATS135BSM-1	ATS135BSM-1E	18pF	Fundamental	24.576000	ATS245SM-1	ATS245SM-1E	Series	Fundamental
14.000000	ATS140BSM-1	ATS140BSM-1E	18pF	Fundamental	24.576000	ATS24BSM-1	ATS24BSM-1E	20pF	Fundamental
14.318180	ATS143SM-1	ATS143SM-1E	Series	Fundamental	24.576000	ATS245ASM-1	ATS245ASM-1E	18pF	Fundamental
14.318180	ATS144SM-1	ATS144SM-1E	20pF	Fundamental	25.000000	ATS250SM-1	ATS250SM-1E	Series	Fundamental
14.318180	ATS143BSM-1	ATS143BSM-1E	18pF	Fundamental	25.000000	ATS25ASM-1	ATS25ASM-1E	20pF	Fundamental
14.745600	ATS147SM-1	ATS147SM-1E	Series	Fundamental	25.000000	ATS250BSM-1	ATS250BSM-1E	18pF	Fundamental
14.745600	ATS147ASM-1	ATS147ASM-1E	20pF	Fundamental	26.000000	ATS260ASM-1	ATS260ASM-1E	20pF	Fundamental
14.745600	ATS147BSM-1	ATS147BSM-1E	18pF	Fundamental	26.000000	ATS260BSM-1	ATS260BSM-1E	18pF	Fundamental
15.000000	ATS150SM-1	ATS150SM-1E	Series	Fundamental	27.000000	ATS270ASM-1	ATS270ASM-1E	20pF	Fundamental
15.000000	ATS150BSM-1	ATS150BSM-1E	18pF	Fundamental	27.000000	ATS270BSM-1	ATS270BSM-1E	18pF	Fundamental
15.360000	ATS15ASM-1	ATS15ASM-1E	20pF	Fundamental	28.636360	ATS286ASM-1	ATS286ASM-1E	20pF	Fundamental
16.000000	ATS160SM-1	ATS160SM-1E	Series	Fundamental	30.000000	ATS300ASM-1	ATS300ASM-1E	20pF	Fundamental
16.000000	ATS16ASM-1	ATS16ASM-1E	20pF	Fundamental	30.000000	ATS300BSM-1	ATS300BSM-1E	18pF	Fundamental
16.000000	ATS16BSM-1	ATS16BSM-1E	18pF	Fundamental	32.000000	ATS320SM-1	ATS320SM-1E	Series	3rd Overtone
16.384000	ATS164BSM-1	ATS164BSM-1E	18pF	Fundamental	32.000000	ATS32ASM-1	ATS32ASM-1E	20pF	3rd Overtone
16.934400	ATS169SM-1	ATS169SM-1E	20pF	Fundamental	32.000000	ATS320BSM-1	ATS320BSM-1E	18pF	3rd Overtone
18.432000	ATS184SM-1	ATS184SM-1E	Series	Fundamental	33.000000	ATS330ASM-1	ATS330ASM-1E	20pF	3rd Overtone
18.432000	ATS18ASM-1	ATS18ASM-1E	20pF	Fundamental	33.000000	ATS330BSM-1	ATS330BSM-1E	18pF	3rd Overtone
18.432000	ATS184BSM-1	ATS184BSM-1E	18pF	Fundamental	36.000000	ATS360ASM-1	ATS360ASM-1E	20pF	3rd Overtone
19.660800	ATS196SM-1	ATS196SM-1E	Series	Fundamental	36.000000	ATS360BSM-1	ATS360BSM-1E	18pF	3rd Overtone
19.660800	ATS19ASM-1	ATS19ASM-1E	20pF	Fundamental	40.000000	ATS400SM-1	ATS400SM-1E	Series	3rd Overtone
19.660800	ATS196BSM-1	ATS196BSM-1E	18pF	Fundamental	40.000000	ATS40ASM-1	ATS40ASM-1E	20pF	3rd Overtone
20.000000	ATS200SM-1	ATS200SM-1E	Series	Fundamental	40.000000	ATS400BSM-1	ATS400BSM-1E	18pF	3rd Overtone
20.000000	ATS20ASM-1	ATS20ASM-1E	20pF	Fundamental	48.000000	ATS480ASM-1	ATS480ASM-1E	20pF	3rd Overtone
20.000000	ATS200CSM-1	ATS200CSM-1E	18pF	Fundamental	48.000000	ATS480BSM-1	ATS480BSM-1E	18pF	3rd Overtone
20.000000	ATS20BSM-1	ATS20BSM-1E	50pF	Fundamental	60.000000	ATS600ASM-1	ATS600ASM-1E	20pF	3rd Overtone
20.480000	ATS204SM-1	ATS204SM-1E	20pF	Fundamental	60.000000	ATS600BSM-1	ATS600BSM-1E	18pF	3rd Overtone
22.118400	ATS22ASM-1	ATS22ASM-1E	20pF	Fundamental	64.000000	ATS640ASM-1	ATS640ASM-1E	20pF	3rd Overtone
22.118400	ATS221BSM-1	ATS221BSM-1E	18pF	Fundamental	64.000000	ATS640BSM-1	ATS640BSM-1E	18pF	3rd Overtone



Electrical Specifications

Operating Conditions

PARAMETER	SYMBOL	CONDITIONS	MIN	TYP	MAX	UNIT
Operating Temperature	T_A	-	-20	+25	+70	°C
			-40		+85	
Storage Temperature	T_{STG}	-	-40	-	+125	°C

Frequency Stability

PARAMETER	SYMBOL	CONDITIONS	MIN	TYP	MAX	UNIT
Frequency Range						
Fundamental	f_0	-		3.2 - 40		MHz
3rd Overtone				24 - 64		
Frequency Tolerance	$\Delta f/f_0$	@ +25°C	-30	-	30	ppm
Frequency Stability	$\Delta f/f_{25}$	Referenced to +25°C reading	-50	-	50	ppm
Aging	$\Delta f/f_0$	Typical per year @ +25°C	-5	±3	5	ppm

Crystal Parameters

PARAMETER	SYMBOL	CONDITIONS	MIN	TYP	MAX	UNIT
Operating Mode	-	-	Fundamental or 3rd Overtone			-
Crystal Cut	-	-	AT-Cut			-
Load Capacitance	C_L	-	Note 1			pF
Shunt Capacitance	C_0	-	-	-	7.0	pF
Series Resistance						
Fundamental	R1	3.2MHz - <4.0MHz	-	-	150	Ω
		4.0MHz - <5.0MHz	-	-	120	
		5.0MHz - <8.0MHz	-	-	80	
		8.0MHz - <12.0MHz	-	-	60	
		12.0MHz - <20.0MHz	-	-	40	
		20.0MHz - 40.0MHz	-	-	30	
3rd Overtone	R1	24.0MHz - <48.0MHz	-	-	80	
		48.0MHz - 64.0MHz	-	-	60	
Drive Level	DL	-	-	100	1000	μW
Insulation Resistance	R_i	+100Vdc ±15Vdc	500	-	-	MΩ

1.] Refer to Standard Product Part Numbers tables on Pages 2 and 3.

$\Delta f/f_0$ - Frequency deviation referenced to nominal frequency.

$\Delta f/f_{25}$ - Frequency deviation over operating temperature range, referenced to +25°C frequency.

Mechanical Specifications

ATS – Package Drawing

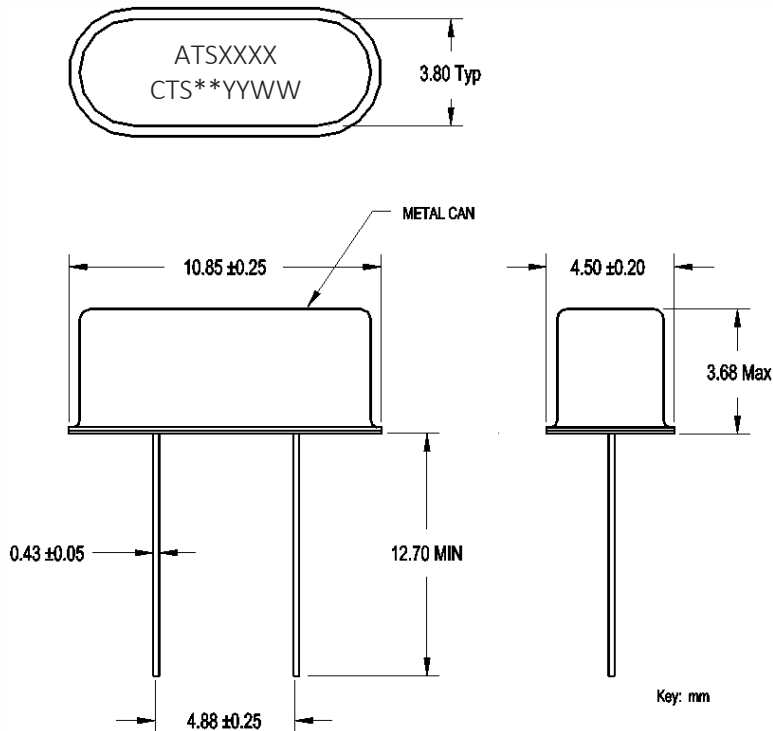

Schematic



Marking Information

1. ATSXXXX – CTS Part Number.
 - a) The package code “1’ is not required in the marking.
 - b) The –E is required in the marking for -40°C/+85°C temperature range parts. [See Standard Product Part Number tables.]
2. ** – Manufacturing Site Code.
3. YYWW – Date Code; YY = year, WW = week.

Notes

1. JEDEC termination code (e1). Barrier-plating is nickel [Ni] with tin-silver-copper [SnAgCu] lead finish.
2. Manual soldering with application to PCB and device terminals, 2 times. Solder iron temperature [@ tip] +350°C maximum, 10 seconds maximum.
3. MSL = 1.

Mechanical Specifications

ATS-SM – Package Drawing

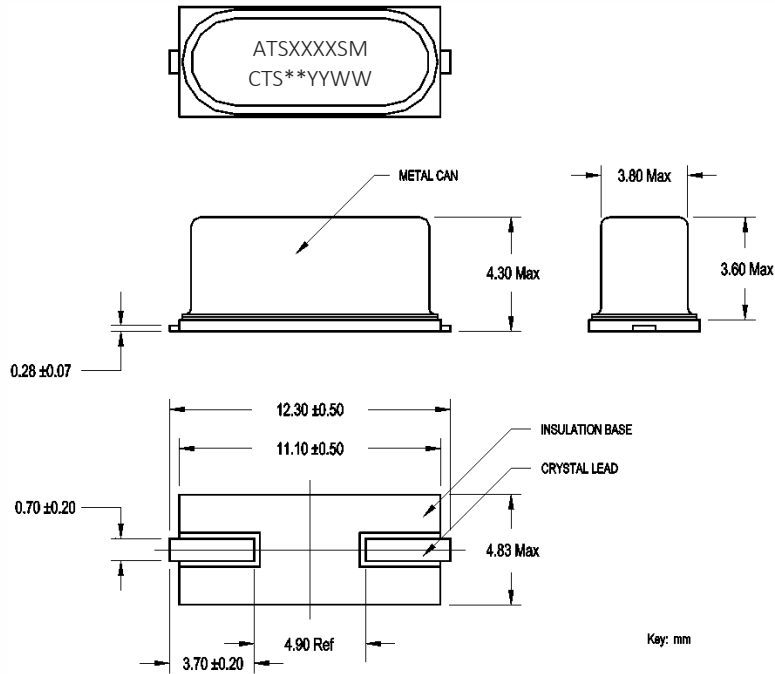

Recommended Pad Layout

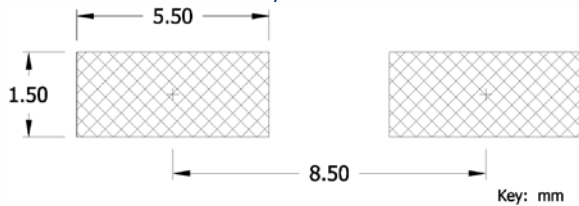

Schematic



Marking Information

1. ATSXXXXSM – CTS Part Number.
 - a) The package code “1” is not required in the marking.
 - b) The –E is required in the marking for -40°C/+85°C temperature range parts. [See Standard Product Part Number tables.]
2. ** – Manufacturing Site Code.
3. YYWW – Date Code; YY = year, WW = week.

Notes

1. JEDEC termination code (e1). Barrier-plating is nickel [Ni] with tin-silver-copper [SnAgCu] lead finish.
2. Reflow conditions per JEDEC J-STD-020; +260°C maximum, 20 seconds.
3. MSL = 1.

Packaging - ATS, Bulk in Bag or Radial Taping

Bulk in Bag – Standard

Packaging is bulk in anti-static plastic bag.

Radial Taping – Optional

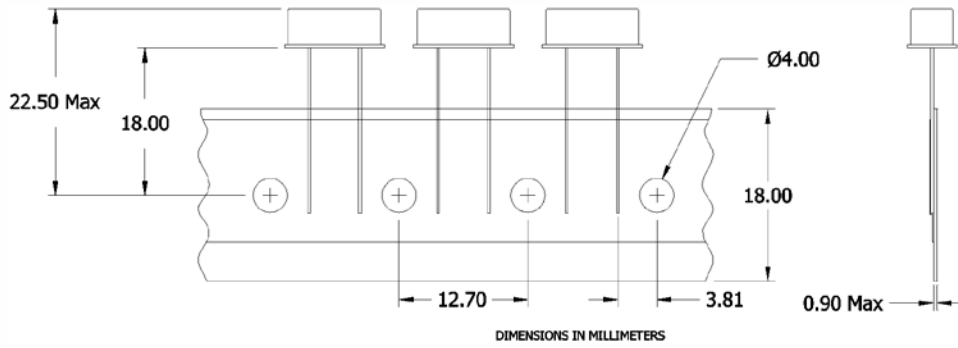

Notes

1. Complete CTS part number, frequency value, date code and manufacturing site code information must appear on bag, reel and carton labels.

Packaging - ATS-SM, Tape and Reel

Tape Drawing

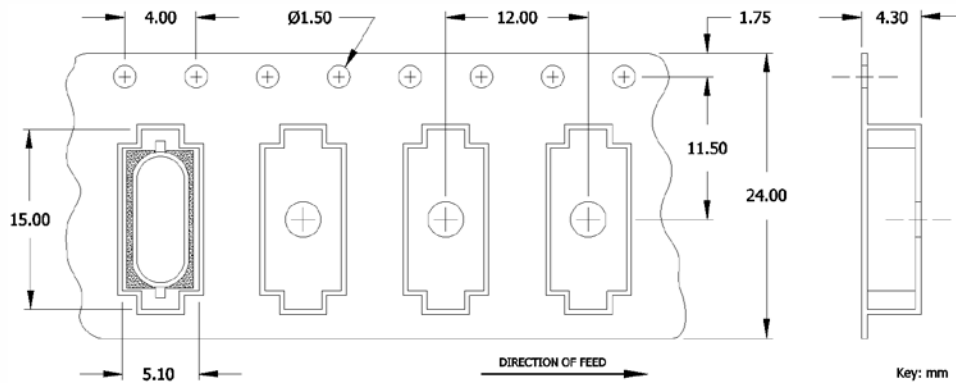

Reel Drawing

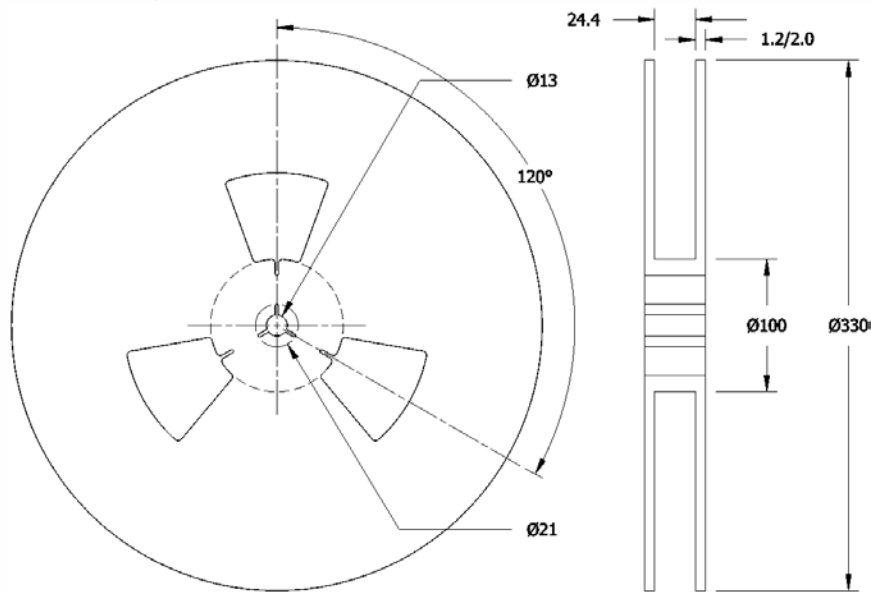

Notes

1. Device quantity is 1k pieces maximum per 330mm reel.
2. Complete CTS part number, frequency value, date code and manufacturing site code information must appear on reel and carton labels.