

IRPLHID2

HID Ballast for 70W Lamp Using the IRS2573D

Table of Contents

	Page
1. Features	2
2. Overview	3
3. Electrical Characteristic.....	4
4. Circuit Schematic	5
5. Functional Description.....	7
6. Fault Conditions	15
7. Dimensioning	18
8. PCB Layout Considerations	23
9. Bill of Materials.....	24
10. IRPLHID2 PCB Layout.....	26
11. Inductor Specifications	28

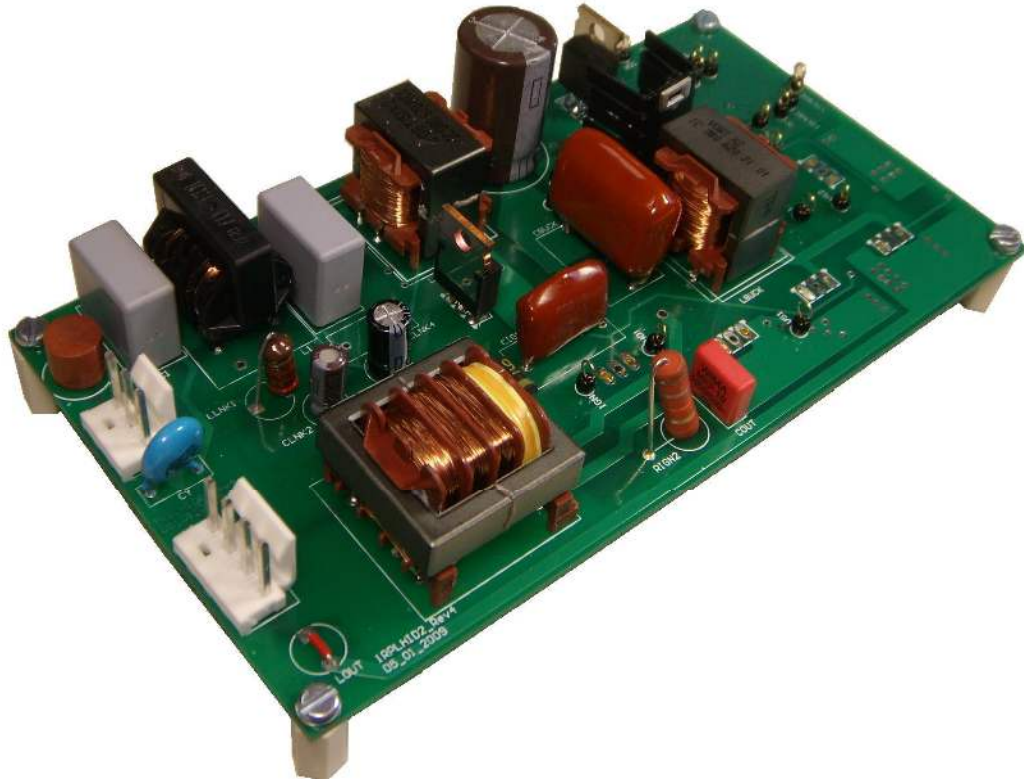

1. Features

- Drives 1 x 70W HID lamp
- Input voltage range: 185-265 VAC
- High Power Factor / Low Total Harmonic Distortion
- Controlled ignition
- Low frequency square wave operation
- Lamp power and current control
- Open circuit and no-lamp protection
- Short circuit and lamp failure to warm-up protection
- Lamp end-of-life shutdown
- IRS2573DSPbF HID Ballast Control IC

2. Overview

The IRPLHID2 reference design kit consists of a complete ballast solution for a 70W HID lamp. The design contains an EMI filter, low voltage power supply, active power factor correction and a ballast control circuit using the IRS2573D. This demo board is intended to help with the evaluation of the IRS2573D HID ballast control IC, demonstrate PCB layout techniques and serve as an aid in the development of production ballasts using the IRS2573D.

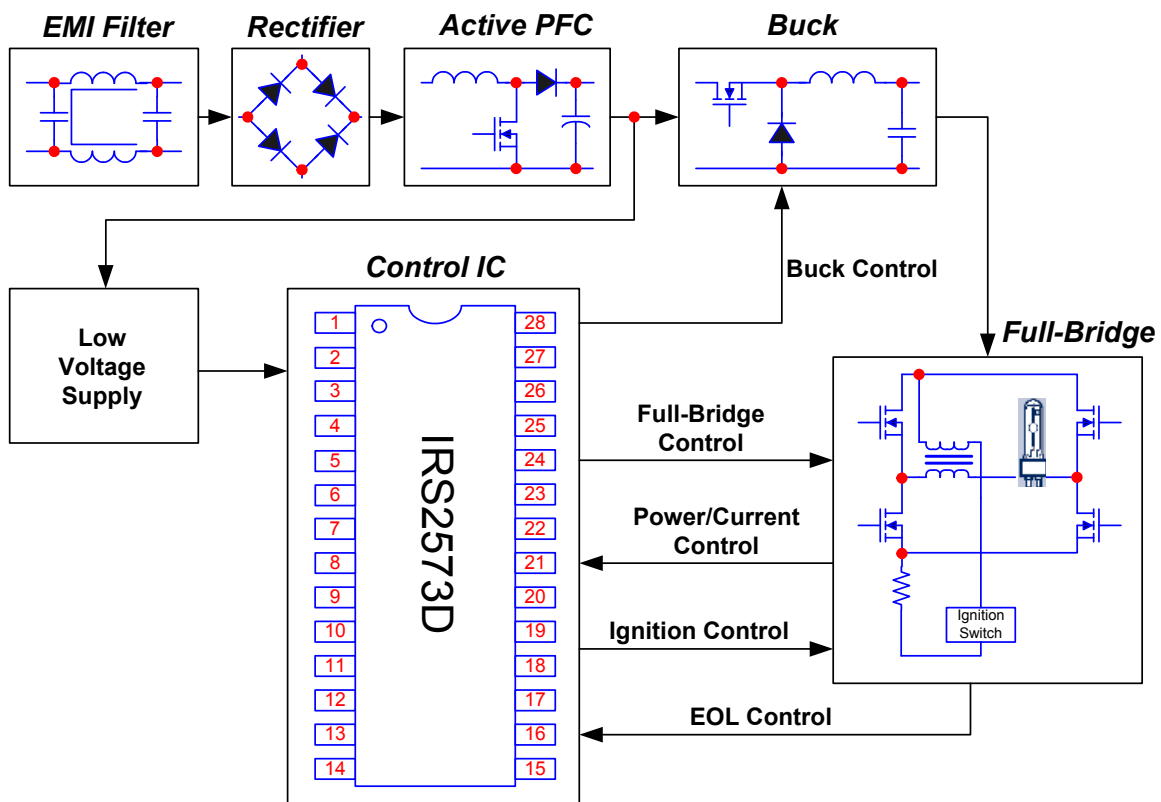

Figure 2.1: IRPLHID2 Block Diagram

3. Electrical Characteristic

Parameter	Units	Value
Lamp Power	[W]	70
Input Power	[W]	73
Input Voltage	[VACrms]	220
Input Current	[mArms]	338
Lamp Running Voltage	[Vpp]	160
Lamp Running Current	[App]	1.6
Output Frequency	[Hz]	149
Power Factor		0.98 at 220 VAC
Total Harmonic Distortion	[%]	10 at 220 VAC
Input AC Voltage Range	[VACrms]	185 - 265

TABLE 3.1: Ballast Parameters.

4. Circuit Schematic 1

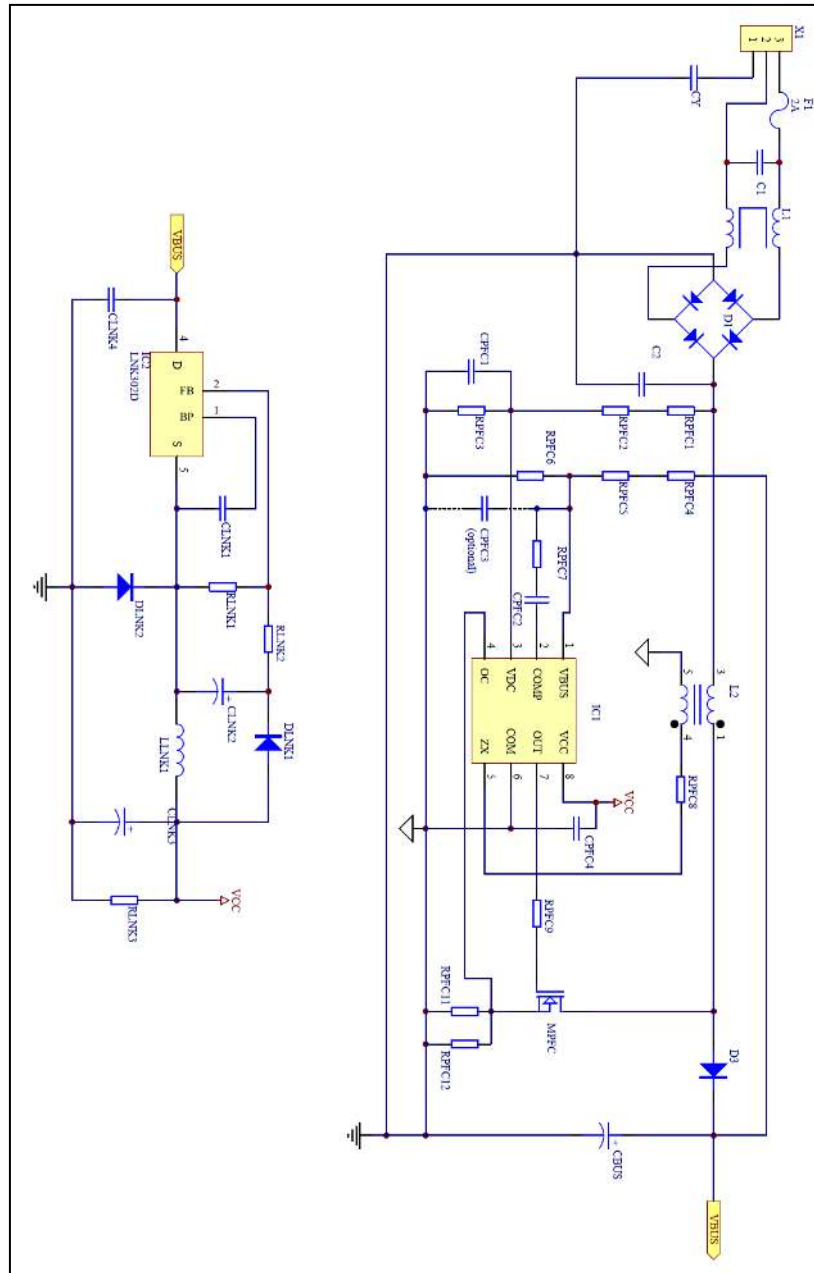

Figure 4.1: IRPLHID2 Circuit Schematic 1

Circuit Schematic 2

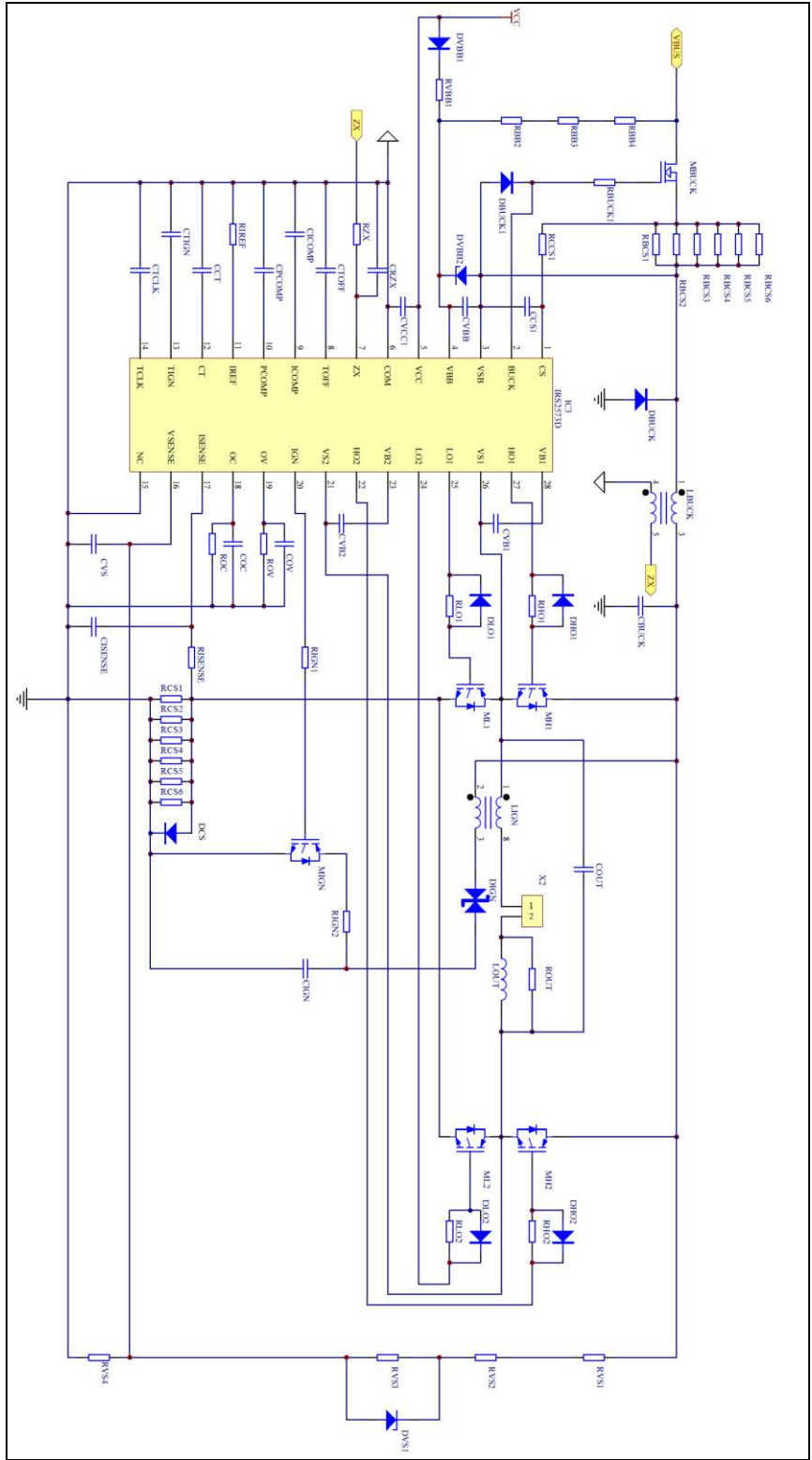

Figure 4.2: IRPLHD2 Circuit Schematic 2

5. Functional Description

HID lamps have unique electrical characteristics, and require a careful control method. Specifically, they require a high voltage for ignition, typically 3 kV to 4 kV, current limitation during warm-up, and constant power control during running. It is important to tightly regulate lamp power with respect to lamp voltage to minimize lamp-to-lamp color and brightness variations. Also, HID lamps should be driven using an AC-voltage to avoid mercury migration, and at a low frequency, typically less than 200 Hz, to prevent lamp damage or explosion due to acoustic resonance. All of these requirements are integrated in the IRS2573D.

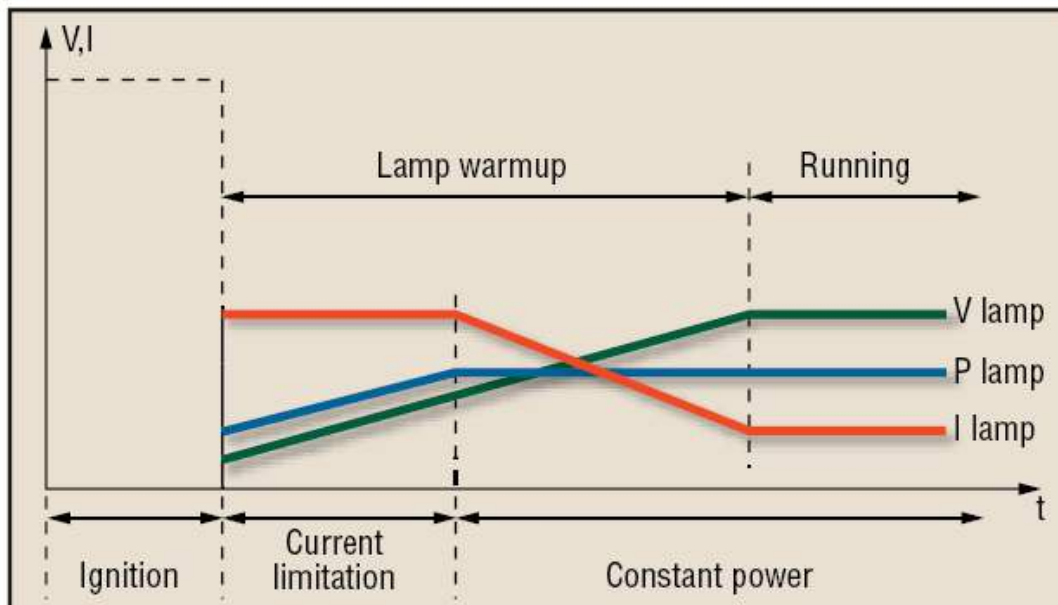

Figure 5.1: HID lamp ignition, warm-up and running modes

The IRS2573D is a fully-integrated, fully-protected 600V HID control IC designed to drive all types of HID lamps. Internal circuitry provides control for ignition, warm-up, running and fault operating modes. The IRS2573D features include ignition timing control, constant lamp power control, current limitation control, programmable full-bridge running frequency, programmable over and under-voltage protection and programmable over-current protection. Advanced protection features such as failure of a lamp to ignite, open load, short-circuit and a programmable fault counter have also been included in the design.

5.1 IRS2573D State and Timing Diagram

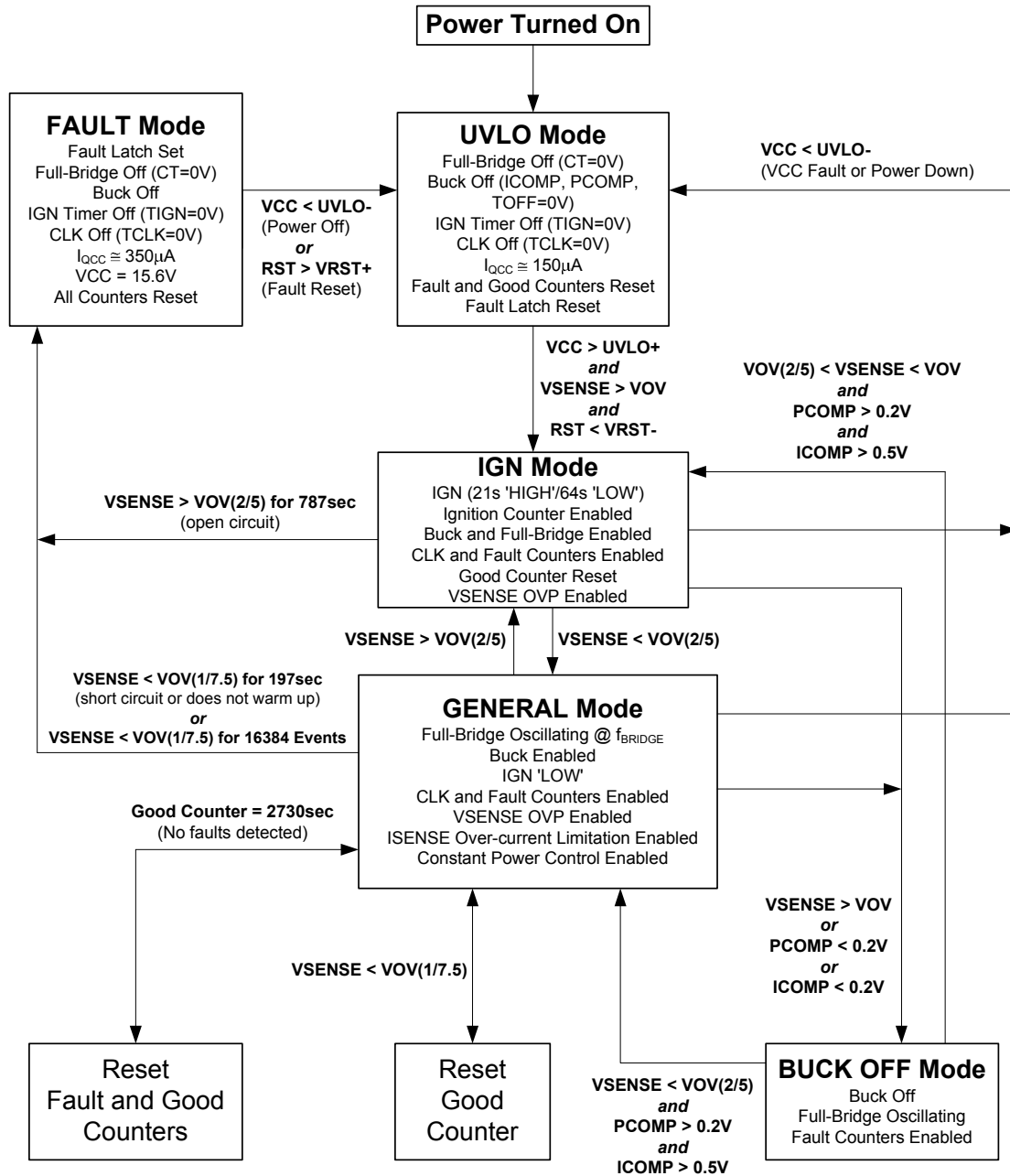

Figure 5.2: IRS2573D state and timing diagram

5.2 Under-voltage Lockout (UVLO) Mode

The under-voltage lockout mode (UVLO) is defined as the state the IC is in when VCC is below the turn-on threshold of the IC. The IC is designed to maintain an ultra-low supply current during UVLO mode of 150uA, and to guarantee the IC is fully functional before

the buck high-side and full-bridge high and low-side output drivers are activated. The low voltage power supply is realized with buck converter circuit utilizing the Link Switch LNK302D (Figure 4.1). Once the voltage on VCC reaches the start-up threshold (UVLO+), voltage on VSENSE pin is above VOV threshold and the voltage on RST pin is less than 1.5V, the IC turns on and the full-bridge oscillator (CT) and gate driver outputs (HO1, LO1, HO2 and LO2) begin to oscillate. During UVLO mode, the full-bridge and buck are off, the ignition timer and clock are off, the fault and good counters are reset, and the fault latch is reset.

5.3 Ignition Mode

The ignition timer is enabled when the IC first enters IGN Mode. The ignition timer frequency is programmed with the external capacitor at the TIGN pin. CTIGN charges up and down linearly through internal sink and source currents between a fixed voltage window of 2V and 4V (Figure 5.3). This sets up an internal clock (666ms typical) that is divided out 128 times and then used to turn the ignition gate driver output (IGN pin) on and off for a given on and off-time (21sec 'high'/64sec 'low' typical). A logic 'high' at the IGN pin will turn the external ignition MOSFET (MIGN) on and enable the external sidac-controlled pulse ignition circuit.

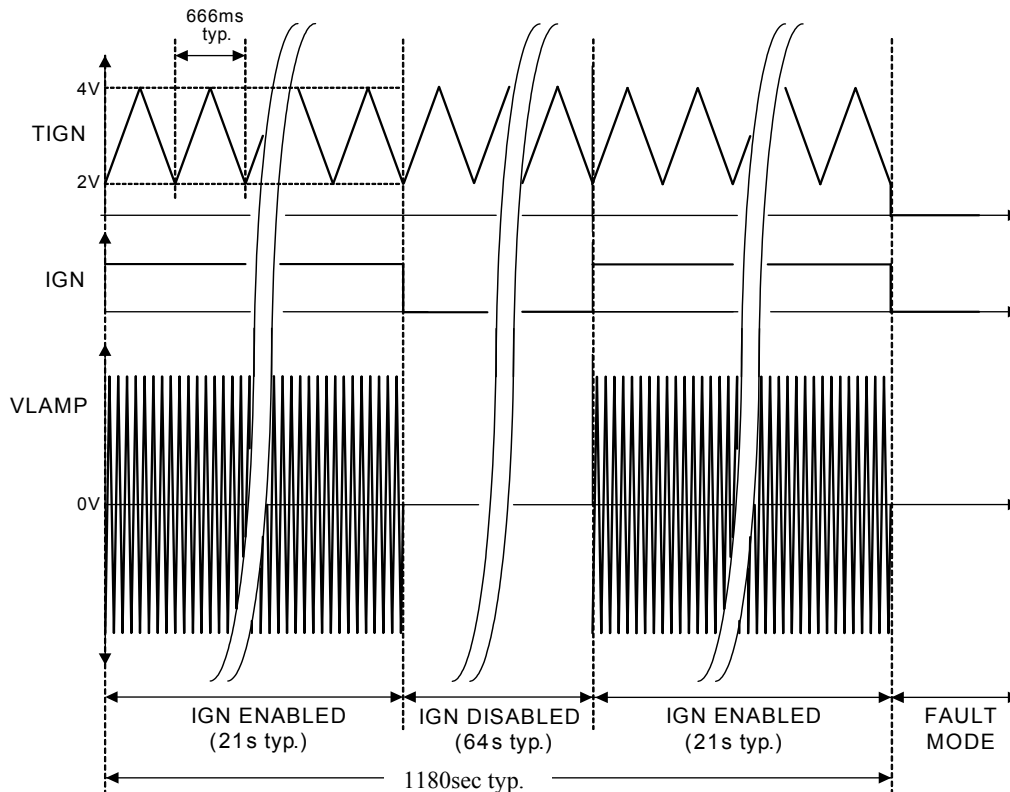

Figure 5.3: Ignition Timer Timing Diagram

During the ignition phase, the lamp is an open circuit and the buck output voltage is limited to a maximum value. The ignition circuit comprises of a diac (DIGN), transformer

(LIGN), capacitor (CIGN), resistor (RIGN2) and switch (MIGN). When the IC turns on the switch MIGN, capacitor CIGN discharges through resistor RIGN2. When the voltage across DIGN reaches the diac threshold voltage (Figure 5.4), DIGN turns on and a current pulse flows from the buck output, through the primary winding of LIGN and into capacitor CIGN. This arrangement generates a high-voltage pulse on the secondary to ignite the lamp. The capacitor CIGN charges up until the diac turns off, and CIGN then discharges down through resistor RIGN until the diac voltage again reaches the device's threshold and another ignition pulse occurs.

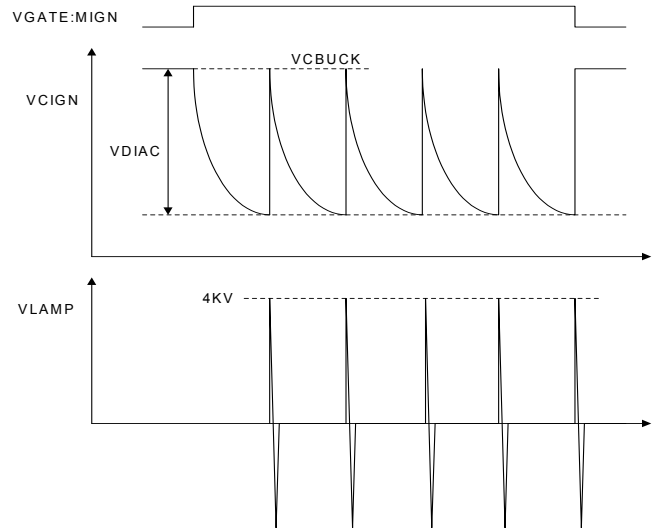

Figure 5.4: Ignition circuit timing diagram

The ignition circuit will continuously try to ignite the HID lamp for 21sec 'on' and 64sec 'off' until the lamp ignites. If the lamp does not ignite after 1180sec then the IC will enter Fault Mode and latch off. If the lamp ignites successfully, the voltage at the VSENSE pin will fall below $VOV(2/5)$ due to the low impedance of the lamp and the ignition timer will be disabled (logic 'low' at the IGN pin).

5.4 General Mode

During General Mode, the IC reacts to the different load conditions (open-circuit, short-circuit, lamp warm-up, constant power running, under-voltage lamp faults, transient under-voltage lamp faults, over-voltage lamp faults, lamp non-strike, etc.) by turning the buck circuit on or off, adjusting the buck circuit on-time, or counting the occurrence of the different fault conditions and turning the complete IC off. The IC senses the different load conditions at the VSENSE and ISENSE pins, compares the voltages at these pins against the programmed thresholds at the OV and OC pins, and determines the correct operating mode of the IC (see State Diagram).

5.5 Full-Bridge Control

The IC includes a complete high and low-side full-bridge driver necessary for driving the

HID lamp with an AC square-wave voltage. The full-bridge begins oscillating at the programmed frequency immediately when the IC comes out of UVLO Mode and turns on. The full-bridge is typically driven at a low frequency to prevent acoustic resonances from damaging the lamp. The full-bridge frequency is programmed with the external capacitor at the CT pin. CT charges up and down linearly through internal sink and source currents between a fixed voltage window of 2V and 4V. CT reaching 4V initiates the toggling of LO1/HO1, and LO2/HO2 respectively (see Figure 5.5). The dead-time is fixed internally at 1.0 μ s typical. During the dead-time, all full-bridge MOSFETs are off and the mid-points of each half-bridge are floating or unbiased. Should an external transient occur during the dead-time due to an ignition voltage pulse, each half-bridge mid-point (VS1 and VS2 pins) can slew high or low very quickly and exceed the dv/dt rating of the IC. To prevent this, internal logic guarantees that the IGN pin is set to a logic 'low' during the dead-time. No ignition pulses can occur until the dead-time has ended and the appropriate full-bridge MOSFETs are turned on. This will guarantee that the mid-points are biased to the output voltage of the buck or COM before an ignition pulse occurs. The full-bridge stops oscillating only when the IC enters Fault Mode or UVLO Mode.

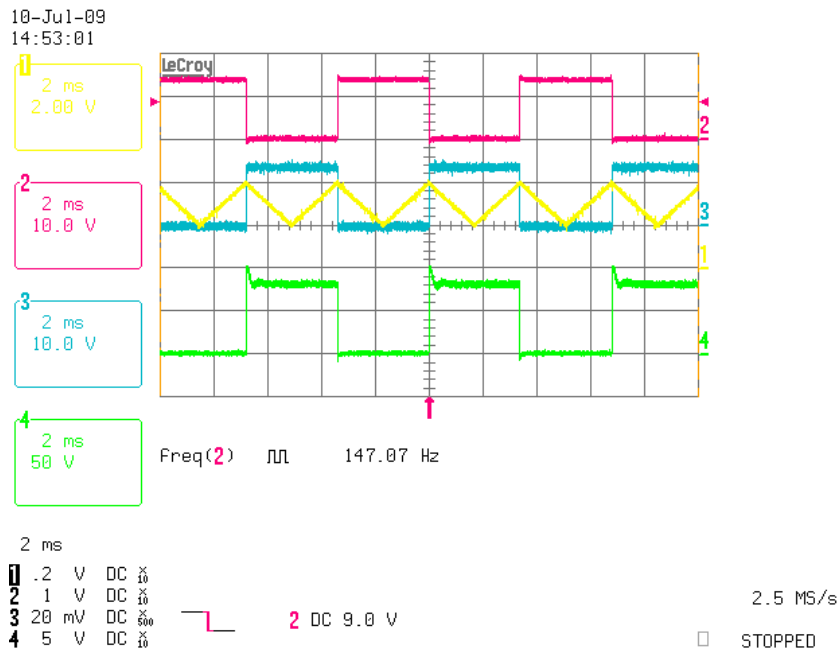

Figure 5.5: Full-bridge timing diagram: CH1 is CT pin voltage, CH2 is LO1 voltage, CH3 is LO2 voltage and CH4 is VS1 pin voltage

5.5 Buck Control

The buck control circuit operates in critical-conduction mode or continuous-conduction mode depending on the off-time of the buck output or the peak current flowing through the buck MOSFET (M_{BUCK}). During normal lamp running conditions, the voltage across the buck current sensing resistor, as measured by the CS pin, is below the internal over-current threshold (1.2V typical). The buck on-time is defined by the time it takes for the internal on-time capacitor to charge up to the voltage level on the PCOMP pin or ICOMP pin, whichever is lower. During the on-time, the current in the buck

inductor charges up to a peak level, depending on the inductance value, and the secondary winding output of the buck inductor is at some negative voltage level, depending on the ratio between the primary and secondary windings. The secondary winding output is measured by the ZX pin, which clamps the negative voltage to a diode drop below COM using the internal ESD diode, and limits the resulting negative current flowing out of the pin with an external resistor, RZX. When the voltage on the internal on-time capacitor exceeds the voltage on the PCOMP pin or ICOMP pin, the on-time has ended and the buck output turns off.

The secondary winding output of the buck inductor transitions to some positive voltage level, depending on the ratio between the primary and secondary windings, and causes the ZX pin to exceed the internal 2V threshold. The current in the buck inductor begins to discharge into the lamp full-bridge output stage. When the inductor current reaches zero, the ZX pin decreases back below the 2V threshold. This causes the internal logic of the buck control to start the on-time cycle again. This mode of operation is known as critical-conduction mode because the buck MOSFET is turned on each cycle when the inductor current discharges to zero. The on-time is programmed by the voltage level on the PCOMP pin, and the off-time is determined by the time it takes for the inductor current to discharge to zero, as measured by a negative-going edge on the ZX pin. The resulting shape of the current in the inductor is triangular with a peak value determined by the inductance value and on-time setting.

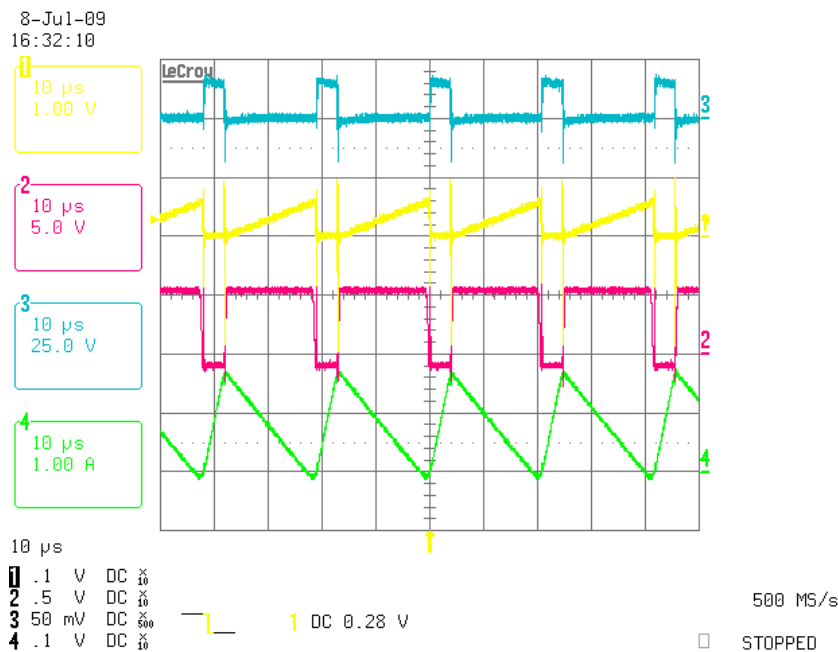

Figure 5.6: Buck control timing diagram (critical conduction mode): CH1 is TOFF pin voltage, CH2 is ZX pin voltage, CH3 is Buck output voltage and CH4 is current through buck inductor LBUCK

During lamp warm-up or a short-circuit condition at the output, the inductor current will charge up to an excessive level that can saturate the inductor or damage the buck MOSFET. To prevent this condition, the buck current sensing resistor (RBCS) is set such that the voltage at the CS pin exceeds the internal over-current threshold (1.2V typical) before the inductor saturates. Should the CS pin exceed 1.2V before the internal

on-time capacitor reaches the voltage level on the PCOMP pin or ICOMP pin, the on-time will end and the buck output will turn off. The off-time is determined by a negative-going edge on the ZX pin, or, if the maximum off time is reached as programmed by the time it takes for the CTOFF on the TOFF pin to charge up to an internal threshold of 2V. If the maximum off-time is reached before the inductor current discharges to zero, then the inductor will begin charging again from some value above zero. This mode of operation is known as continuous-conduction mode and results in a continuous DC current in the inductor with a ripple bounded above by the over-current threshold and below by the maximum off time setting (see Figure 5.7). Continuous-conduction mode also allows for a higher average current to flow through the buck inductor before saturation occurs than with critical-conduction mode.

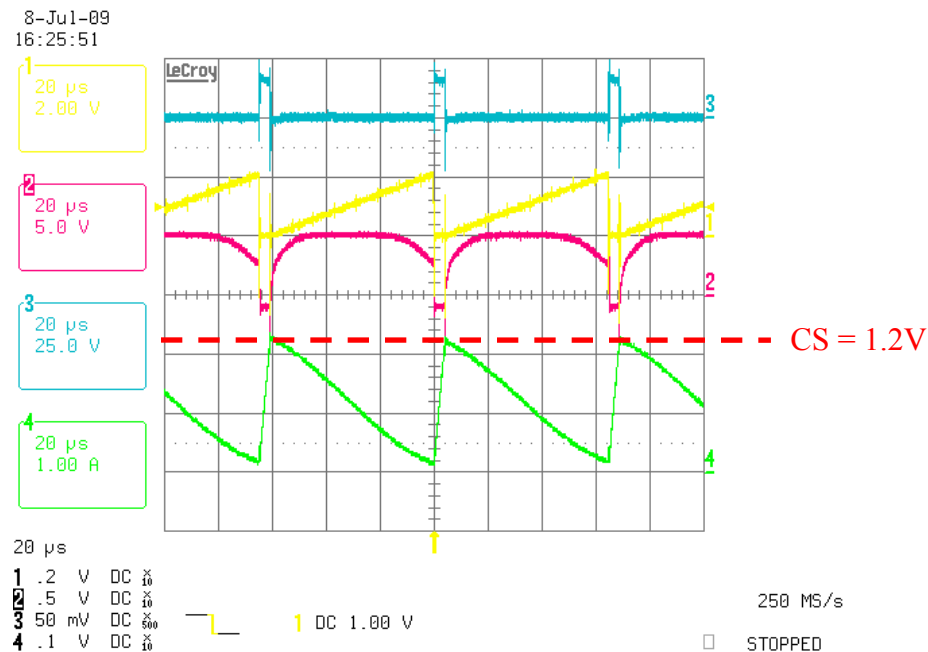

Figure 5.7: Buck control timing diagram (continuous conduction mode): CH1 is TOFF pin voltage, CH2 is ZX pin voltage, CH3 is Buck output voltage and CH4 is current through buck inductor LBUCK

5.6 Constant Power Control

During the general mode of operation and after the lamp has ignited, the IC regulates the lamp output power to a constant level. To achieve this, the IC measures the lamp voltage and lamp current at the VSENSE and ISENSE pins, multiplies the voltage and current together using an internal multiplier circuit to calculate power, and regulates the output of the multiplier circuit to a constant reference voltage by increasing or decreasing the buck on-time. If the lamp power is too low then the output of the multiplier will be below the internal reference voltage. The operational trans-conductance amplifier (OTA) will output a sourcing current to the PCOMP pin that will charge up the CPCOMP to a higher voltage. This will increase the on-time of buck and increase the output current to the lamp for increasing the output power. If the lamp power is too high, then the opposite will occur. The OTA will output a sinking current to the PCOMP pin that will discharge the CPCOMP to a lower voltage. This will decrease the buck on-time and

decrease the output current to the lamp for decreasing the output power. The speed of the constant power control loop is set by the value of the CPCOMP at the PCOMP pin that determines how fast the loop will react and adjust the buck on-time over the changing load conditions.

5.7 Current Limitation Control

The constant power control loop will increase or decrease the buck current for maintaining constant power in the lamp load. During lamp warm-up, the lamp voltage can be very low (20V typical) and the constant power loop will attempt to increase the buck current to several amps of current to maintain constant power. This high current can exceed the manufacturer's maximum current rating for the HID lamp. To prevent this condition, an additional current limitation control loop has been included in the IC. Should the voltage at the ISENSE pin exceed the voltage level at the OC pin, another OTA will sink current from the ICOMP pin. When the ICOMP pin voltage decreases below the PCOMP pin voltage, then the current limitation loop will override the constant power loop and the ICOMP pin will decrease the buck on-time. The lower of the PCOMP or ICOMP pins will override the other and control the buck on-time. When the lamp eventually warms up and the lamp voltage increases to a level where the lamp current is below the maximum allowable limit, then the ICOMP pin voltage will increase above the PCOMP pin voltage, and the PCOMP pin will control the buck on-time again for maintaining constant power.

5.8 Buck OFF Mode

The IC will enter the Buck-OFF Mode if any one of these 3 conditions occur:

- $V_{SENSE} > V_{OV}$ or
- $PCOMP < 0.2V$ or
- $ICOMP < 0.2V$

When in the Buck-OFF Mode, the IC will go back to General Mode if all of these 3 conditions are valid:

- $V_{SENSE} < V_{OV} (2/5)$ and
- $PCOMP > 0.2V$ and
- $ICOMP > 0.5V$

The IC will instead go back to Ignition Mode if all of these 3 conditions are valid:

- $V_{OV}(2/5) < V_{SENSE} < V_{OV}$ and
- $PCOMP > 0.2V$ and
- $ICOMP > 0.5V$

6. Fault Conditions

In case of fault conditions such as open circuit, lamp removal, lamp extinguishes, short circuit, end-of-life and lamp failure to warm-up, the IRS2573D will go into Fault Mode after the fault timer times out. In this mode, the internal fault latch is set, full-bridge and buck are off, ignition and fault timer are off, and the IRS2573D consumes an ultra-low micro-power current. The IRS2573D can be reset with a fault reset (RST > VRST+) or a recycling of VCC below and back above the UVLO thresholds. The fault timer is programmed using the external capacitor CTCLK on the TCLK pin.

6.1 Over-Voltage Fault Counter

The IC includes an over-voltage fault counter at the VSENSE pin. In the IGN Mode, the over-voltage fault counter will count the time during which an over-voltage condition at the output of the buck exists due to an open-circuit condition, lamp extinguishes, lamp removal or end-of-life. Figure 7.1 shows the waveforms when the ballast goes into Fault Mode because of over-voltage fault. When the voltage at the VSENSE pin remains above VOV (2/5) and the over-voltage fault counter times out (1180sec typical, with CTCLK=0.18uF), the IC will enter Fault Mode and shutdown. Before the fault counter times out, the ignition counter is enabled and the IC keeps trying to ignite the lamp for 21 sec 'on' and 64 sec 'off'.

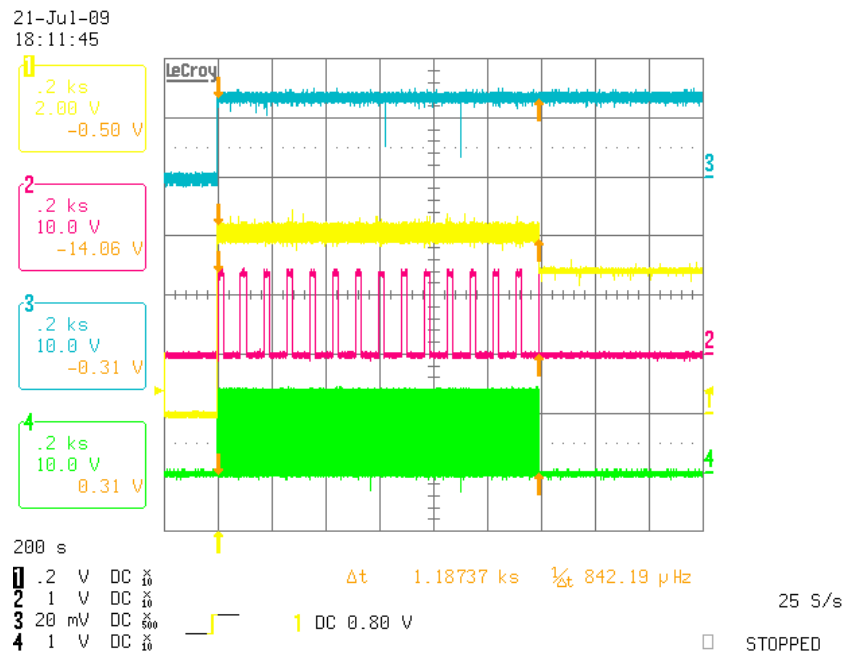

Figure 6.1: Over-voltage fault: CH1 is the VSENSE voltage, CH2 is IGN pin voltage, CH3 is VCC and CH4 is LO voltage

6.2 Under-Voltage Fault Counter

The IC also includes an under-voltage fault counter at the VSENSE pin. Once the lamp has ignited, the lamp voltage will decrease sharply to a very low voltage (20V typical). As the lamp warms up, the lamp voltage will slowly increase until the nominal running voltage is reached (100V typical). If the lamp voltage remains too low for too long, then this is a lamp fault condition and the ballast must shutdown. To detect this, the VSENSE pin includes an under-voltage threshold of $VOV(1/7.5)$. If the voltage at the VSENSE pin remains below $VOV(1/7.5)$ and the under-voltage fault counter times out (295sec typical, with $CTCLK=0.18\mu F$), then the lamp is not warming up properly due to a lamp fault condition (end of life, etc.) and the IC will enter fault mode and shutdown. If the voltage at the VSENSE pin increases above $VOV(1/7.5)$ before the under-voltage counter times out, then the lamp has successfully warmed up and the IC will remain in general mode. Figure 6.2 shows some waveforms when the ballast goes into Fault Mode due to under-voltage fault.

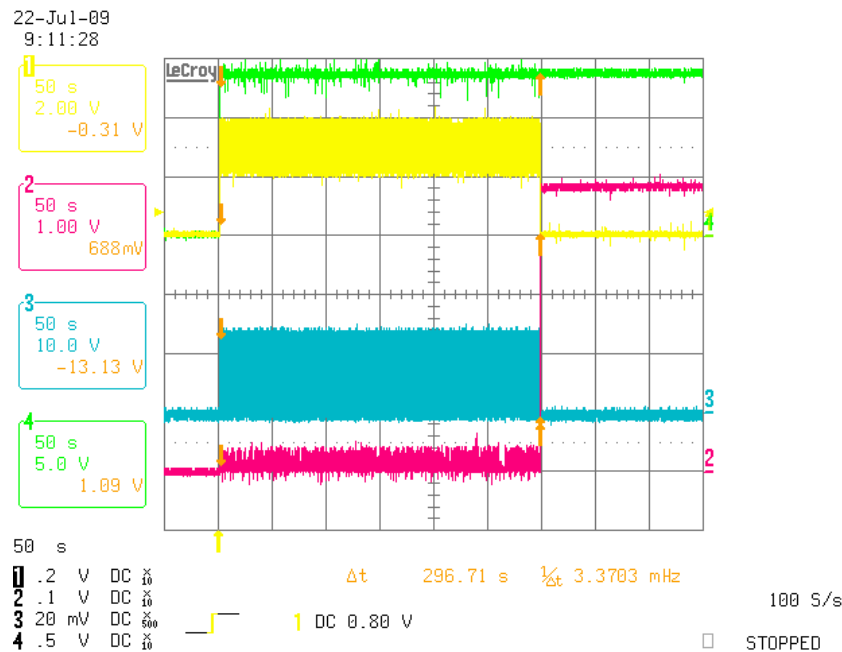

Figure 6.2: Under-voltage fault: CH1 is TCLK pin voltage, CH2 is VSENSE voltage, CH3 is LO voltage and CH4 is VCC voltage

6.3 Fast Transient Under-Voltage Fault Counter

During normal running conditions, fast transient under-voltage spikes can occur on the lamp voltage due to instabilities in the lamp arc. The resulting transients on the VSENSE pin will cycle below and above the $VOV(1/7.5)$ threshold quickly ($<50\mu s$). If the number of events of these transients exceeds the maximum number of events of the fault counter (16,384 events typical), then the IC will enter fault mode and shutdown.

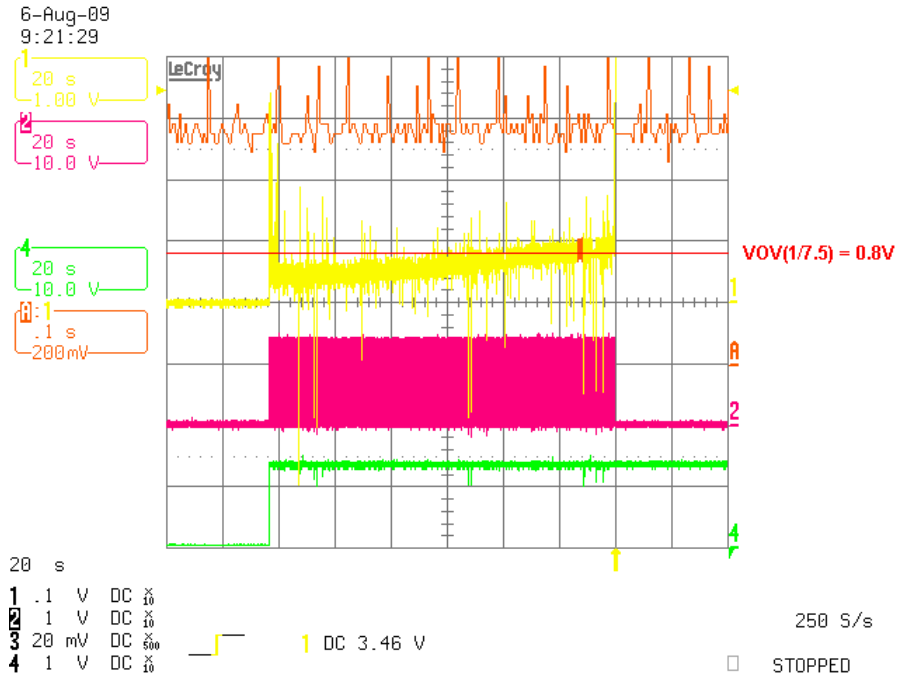

Figure 6.3: Under-voltage fault: CH1 is VSENSE voltage, CH2 is LO voltage, CH4 is VCC voltage and CHA is zoom of VSENSE voltage

6.4 Good Counter

If no faults are detected for a long period of time (2730sec typical), as measured by the good counter, then the fault counter and good counter will both be reset to zero. Also, each time a fault is counted, the good counter is reset to zero.

7. Dimensioning

7.1 Dimensioning: Basic settings

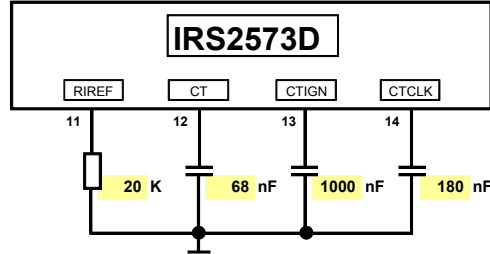

REF - CURRENT	OSC - FREQUENCY	IGNITION - COUNTER	ERROR - COUNTER	GOOD - COUNTER
$I_{REF} = 100 \mu A$	$f_{osc} = 147.1 \text{ Hz}$	$T_{IGNON} = 21 \text{ sec}$ $T_{IGNOFF} = 64 \text{ sec}$	$t_{UVFAULT} = 295 \text{ sec}$ $t_{OVFAULT} = 1180 \text{ sec}$	$T_{GOOD} = 2731 \text{ sec}$

I_{REF} needs to be set to the beginning, because I_{REF} is also used for other settings.

$$I_{REF} = \frac{V_{IREF}}{R_{IREF}} = \frac{2V}{20k\Omega} = 100\mu A \quad (1)$$

CT sets the full bridge frequency.

$$f_{FB} = \frac{I_{CT,SOURCE/SINK}}{8 \times C_{CT}} = \frac{80\mu A}{8 \times 68nF} = 147 \text{ Hz} \quad (2)$$

CTIGN sets the timing for the ignition pulses.

$$T_{IGN,ON} = 32 \times \frac{4 \times C_{TIGN}}{I_{TIGN,SOURCE/SINK}} = 32 \times \frac{4 \times 1000nF}{6\mu A} \quad (3)$$

$$T_{IGN,OFF} = T_{IGN,ON} \times 3 \quad (4)$$

CTCLK sets the time constants for the EOL (Under Voltage Fault/ Over Voltage Fault)

$$T_{UVFAULT} = 16,384 \times \frac{4 \times C_{TCLK}}{I_{TCLK,SOURCE/SINK}} = 16,384 \times \frac{4 \times 180nF}{40\mu A} \quad (5)$$

$$T_{OVFAULT} = 4 \times T_{UVFAULT} \quad (6)$$

7.2 Dimensioning: EOL settings

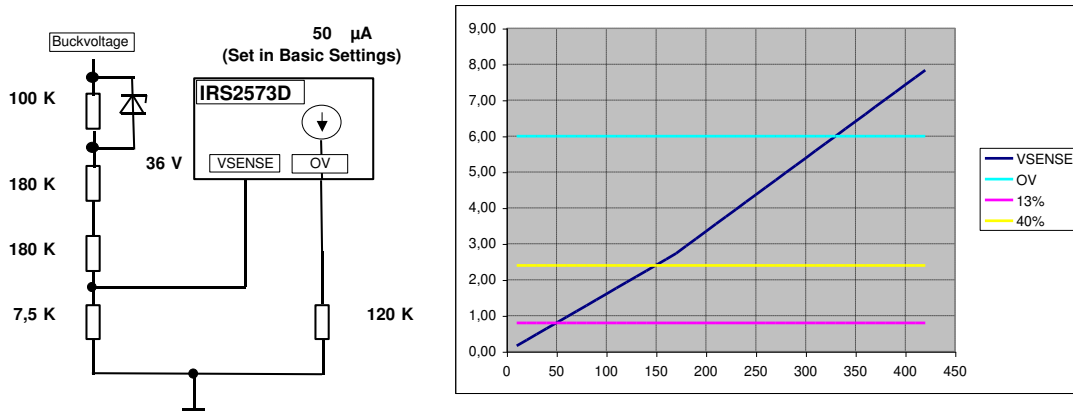

The IRS2573D uses VSENSE pin to detect if fault condition has occurred. The voltage on the OV pin sets the reference for the EOL thresholds.

$V_{SENSE} \leq V_{OV}(1/7.5) \rightarrow$ Lamp under voltage fault (13% of OV)

$V_{SENSE} \geq V_{OV}(2/5) \rightarrow$ Lamp over voltage fault (40% of OV)

$V_{SENSE} \geq V_{OV} \rightarrow$ Buck over voltage threshold (100% of OV)

During the ignition phase the buck voltage is regulated to OV (e.g. 330V). If the buck voltage stays below 13% of OV for more than 295sec or above 40% of OV for 1180sec, the ballast will go to Fault mode and latched.

7.3 Dimensioning: Buck settings

- Lamp parameter**

Start with the lamp parameter:

$$P_{LAMP}=73W$$

$$V_{LAMP}=100V$$

$$I_{LAMP}=0.73A$$

- Buck current sensing resistor**

Buck inductor over-current protection is setup by buck current sensing resistor:

$$I_{OC} = 0.9A$$

$$I_{OC,PEAK} = 2 \times I_{OC} = 1.8A \quad (7)$$

$$R_{BCS} = \frac{V_{CS}}{I_{OC, PEAK}} = \frac{1.2V}{1.8A} = 0.667\Omega \quad (8)$$

- **Buck inductor value**

Select input voltage for the buck, which is the bus voltage provided by boost PFC stage:

$$V_{BUS} = 400V$$

Select nominal frequency of the buck:

$$f = 70kHz$$

Calculate buck inductor value based on nominal frequency, lamp current, buck input and output voltage:

$$L \approx \frac{T}{2 \times I_{LAMP}} \left(1 - \frac{V_{OUT}}{V_{BUS}} \right) \times V_{OUT} = 733\mu H \quad (9)$$

$$\text{where } T = \frac{1}{f} \text{ and } V_{OUT} = V_{LAMP}$$

Buck inductor selection value:

$$L = 750\mu H$$

- **Buck off-time programming capacitor**

Determine buck output minimum voltage (lamp minimum voltage after ignition):

$$V_{OUT, MIN} = 20V(\text{typical})$$

Calculate buck minimum frequency in the boundary between critical- and continuous- conduction mode:

$$\begin{aligned} f_{MIN} &= \frac{1}{I_{OC, PEAK} \times L} \left(V_{OUT, MIN} - \frac{V_{OUT, MIN}^2}{V_{BUS}} \right) \\ &= \frac{1}{1.8 \times 750e-6} \left(20 - \frac{20^2}{400} \right) = 14kHz \end{aligned} \quad (10)$$

Calculate t_{OFF} :

$$t_{OFF} \approx \frac{1 - \frac{V_{OUT,MIN}}{V_{BUS}}}{f}$$

$$= \frac{1 - \frac{20}{400}}{14} = 68\mu s \quad (11)$$

Calculate C_{TOFF} :

$$C_{TOFF} = \frac{I_{REF} \times t_{OFF}}{V_{TOFF}}$$

$$= \frac{100\mu A \times 68\mu s}{2V} = 3.4nF \quad (12)$$

Off-time programming capacitor selection value:

$$C_{TOFF} = 3.3nF$$

- **Current sense and over-current resistor value:**

Calculate the nominal value on VSENSE pin (based on nominal lamp voltage):

$$V_{SENSE,NOM} = V_{LAMP,NOM} \times \frac{RVS4}{RVS1 + RVS2 + RVS3 + RVS4}$$

$$= 100 \times \frac{7.5k}{180k + 180k + 100k + 7.5k} = 1.6V \quad (13)$$

Calculate the nominal value on ISENSE pin:

$$V_{ISENSE,NOM} = \frac{P_{SENSE}}{V_{SENSE,NOM}}$$

$$= \frac{0.5}{1.6} = 0.31V \quad (14)$$

Calculate the value of current sense and over current resistors:

$$R_{CS} = \frac{V_{ISENSE,NOM}}{I_{LAMP}} = 0.43\Omega \quad (15)$$

$$R_{OC} = \frac{1.5 \times I_{OC} \times R_{CS}}{0.5 \times I_{REF}} = 11.6k\Omega \quad (16)$$

Over-current resistor selection value:

$$R_{OC} = 12k\Omega$$

8. PCB Layout Considerations

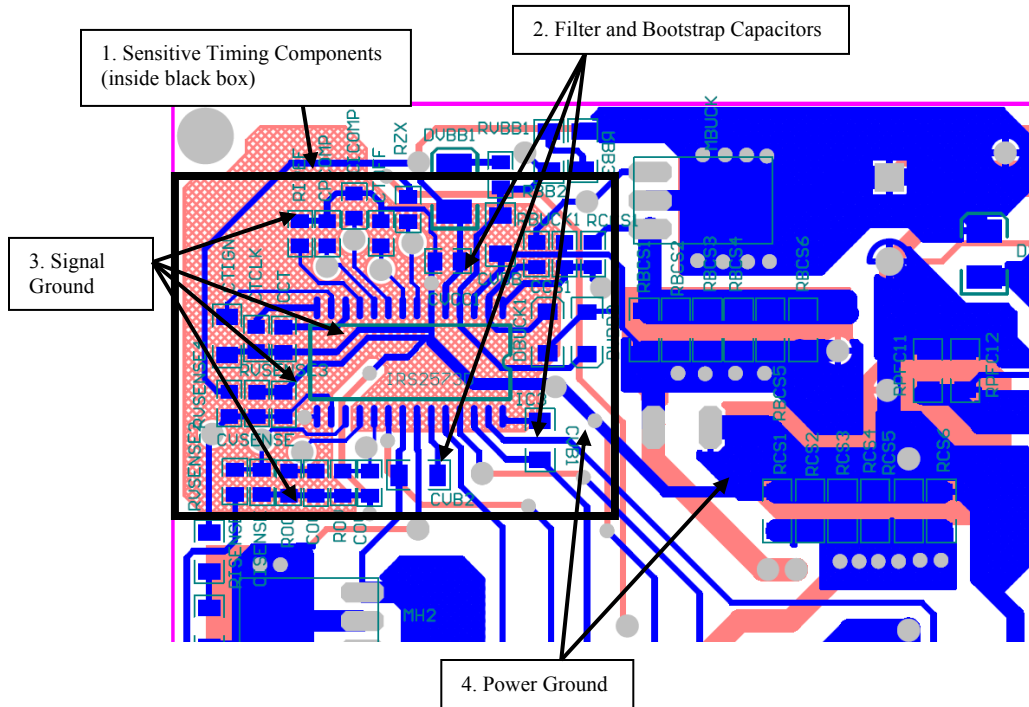

1. The programming and timing components should be placed close to the IC with short traces and with ground connections directly to COM-pin (Pin 6).
2. The filter and bootstrap capacitors should also be placed close to the IC with short tracks.
3. All signal ground connections should go directly to the COM pin.
4. There is only one connection from the IC COM to the power ground. The power ground connections should also be as short as possible and with bigger track size.

Disclaimer

This reference design is intended for evaluation purposes only and has not been submitted or approved by any external test house for conformance with UL or international safety or performance standards. International Rectifier does not guarantee that this reference design will conform to any such standards.

9. Bill of Materials

Item #	Qty	Manufacturer	Part Number	Description	Reference
1	1	IR	IRS2500S	SO8 PFC IC	IC1
2	1	Power Integration	LNK302DN	Link Switch LNK	IC2
3	1	IR	IRS2573D	HID Ballast Control IC	IC3
4	1	IR	IRF840	MOSFET 500V/600V	MBUCK
5	1	IR	IRF830	MOSFET 500V	MPFC
6	5	IR	IRGR3B60KD2	IGBT 600V	MIGN, MH1, ML1, MH2, ML2
7	1	Vishay	8ETH06	Diode 600V	DBUCK
8	1	Vishay	LL4148	Diode, 75V, 100mA	DBUCK1
9	1	Vishay	TZMB15	Zener Diode, 15V, 500mW, MiniMelf	DVBB2
10	1	Vishay	TZMB36	Zener Diode, 36V, 500mW, MiniMelf	DVS1
11	1	Diodes Inc.	DF10S	Bridge Rectifier 1A, 1000V	BR1
12	5	Diodes Inc.	MURS160	Diode, 600V, 1A, SMB	D3, DVBB1, DLNK1, DLNK2, DCS *
13	1	Schindengen	K1V26	Sidac 240V-270V	DIGN
14	1	Würth Elektronik	760801032	Buck Inductor 0.75mH EE20/10/11	LBUCK
15	1	Würth Elektronik	760801070	PFC Inductor 1.5mH EE20/10/11	LPFC
16	1	Würth Elektronik	760370109	Ignition Transformer 1mH EE25/13/7	LIGN
17	1	Panasonic	ELF-15N007A	EMI Inductor	L1
18	1	Epcos	B82144B1225J000	HF-Inductor	LLINK1
19	1	Panasonic	ECQ-E4105KF	Capacitor 1 μ F/400V	CBUCK
20	2	Vishay	2222 338 20334	Capacitor 330nF/275VAC X2	C1,C2
21	1	Epcos	B32652A6104J	Capacitor 100nF/630V	CIGN
22	1	Roederstein	WY0222MCMBF0K	Capacitor 2.2nF/275VAC Y Cap	CY
23	1	Wima	MKP10 1nF/630V	Capacitor 1nF/630V	COU
24	1	Panasonic	ECE-A1EN330U	Capacitor 33 μ F/25V	CLNK3
25	1	Panasonic	EEU-EB2W220S	Capacitor 22 μ F/450V	CBUS
26	1	Panasonic	ECA-1HM100I	Capacitor 10 μ F/50V	CLNK2
27	3	Panasonic	ECJ-3YF1E225Z	Capacitor, 2.2 μ F, 25V, 1206	CVB1, CVB2, CVBB
28	1	Panasonic	ECJ-3YB1E105K	Capacitor, 1 μ F, 25V, 1206	CTIGN
29	1	Panasonic	ECJ-2FB1E105K	Capacitor, 1 μ F, 25V, 0805	CPFC2
30	1	Multicomp	MCCA000282	Capacitor, 270nF, 16V, 0805	CTCLK
31	6	Panasonic	ECJ-2YB1H104K	Capacitor, 100nF, 50V, 0805	CVCC1, COV, COC, CISENSE, CLINK1, CPFC4
32	1	Panasonic	ECJ-2YB1H683K	Capacitor, 68nF, 50V, 0805	CCT
33	1	Panasonic	ECJ-2VB1H333K	Capacitor, 33nF, 50V, 0805	CPCOMP
34	1	Panasonic	ECJ-2VB1H223K	Capacitor, 22nF, 50V, 0805	CVS
35	1	Panasonic	ECJ-2VB1H472K	Capacitor, 4.7nF, 50V, 0805	CPFC1
36	1	Panasonic	ECJ-2VB1H332K	Capacitor, 3.3nF, 50V, 0805	CTOFF
37	1	Panasonic	ECJ-2VB1H102K	Capacitor, 1nF, 50V, 0805	CICOMP
38	1	Panasonic	ECJ-2VC1H471J	Capacitor, 470pF, 50V, 0805	CCS1
39	1	Panasonic	ECJ-2VC1H100D	Capacitor, 10pF, 50V, 0805	CRZX

* Note: M1 MOSFET has been replaced by DCS on the IRPLHID2 PCB. See the schematic for further details.

40	2	Panasonic	ERJ-8ENF1004V	Resistor, 1M Ω , 0.25W, 1%, 1206	RPFC1, RPFC2
41	2	Panasonic	ERJ-8ENF8203V	Resistor, 820k Ω , 0.25W, 1%, 1206	RPFC4, RPFC5
42	2	Panasonic	ERJ-8ENF1803V	Resistor, 180k Ω , 0.25W, 1%, 1206	RVS1, RVS2
43	1	Panasonic	ERJ-6ENF1203V	Resistor, 120k Ω , 0.125W, 1%, 0805	ROV
44	1	Panasonic	ERJ-8ENF1003V	Resistor, 100k Ω , 0.25W, 1%, 1206	RVS3
45	3	Panasonic	ERJ-8ENF6802V	Resistor, 68k Ω , 0.25W, 1%, 1206	RBB2, RBB3, RBB4
46	2	Panasonic	ERJ-6ENF3302V	Resistor, 33k Ω , 0.125W, 1%, 0805	RZX, RPFC8
47	1	Panasonic	ERJ-6ENF2002V	Resistor, 20k Ω , 0.125W, 1%, 0805	RIREF
48	1	Panasonic	ERJ-6ENF1502V	Resistor, 15k Ω , 0.125W, 1%, 0805	RLNK2
49	1	Panasonic	ERJ-6ENF1302V	Resistor, 13k Ω , 0.125W, 1%, 0805	ROC
50	3	Panasonic	ERJ-6ENF1002V	Resistor, 10k Ω , 0.125W, 1%, 0805	RPFC3, RPFC6, RPFC7
51	1	Panasonic	ERJ-6ENF7501V	Resistor, 7.5k Ω , 0.125W, 1%, 0805	RVS4
52	1	Panasonic	ERJ-8ENF3301V	Resistor, 3.3k Ω , 0.25W, 1%, 1206	RLNK3
53	1	Panasonic	ERJ-6ENF2202V	Resistor, 2.2k Ω , 0.125W, 1%, 0805	RLNK1
54	2	Panasonic	ERJ-6ENF1001V	Resistor, 1k Ω , 0.125W, 1%, 0805	RISENSE, RCCS1
55	8	Panasonic	ERJ-S06F22R0V	Resistor, 22 Ω , 0.125W, 1%, 0805	RBUCK1, RPFC9, RIGN1 RHO1, RLO1, RHO2, RLO2, RIGN3
56	1	Panasonic	ERJ-S06F10R0V	Resistor, 10 Ω , 0.125W, 1%, 0805	RVBB1
57	8	Panasonic	ERJ-8RQF3R3V	Resistor, 3.3 Ω , 0.25W, 1%, 1206	RBCS1, RBCS2, RBCS3, RBCS4, RBCS5, RCS1, RCS2, RCS3
58	3	Panasonic	ERJ-8RQF2R2V	Resistor, 2.2 Ω , 0.25W, 1%, 1206	RCS4, RCS5, RCS6
59	2	Panasonic	ERJ-8RQF1R2V	Resistor, 1 Ω , 0.25W, 1%, 1206	RPFC11, RPFC12
60	1	Vishay	PR03000201802JAC00	Resistor 18K/3W	RIGN2
61	1	Tyco	644753-3	3-pin Connector	X1
62	1	Tyco	644753-4	4-pin Connector	X2
63	2	Fisher Elektronik	FK 237 SA 220 O	Heatsink, TO-220	DBUCK, MBUCK
64	1	-	-	Jumper	LOUT
65	22	-	-	Test Points	-

TABLE 9.1: IRPLHID2 Bill of Materials.

10. IRPLHID2 PCB Layout

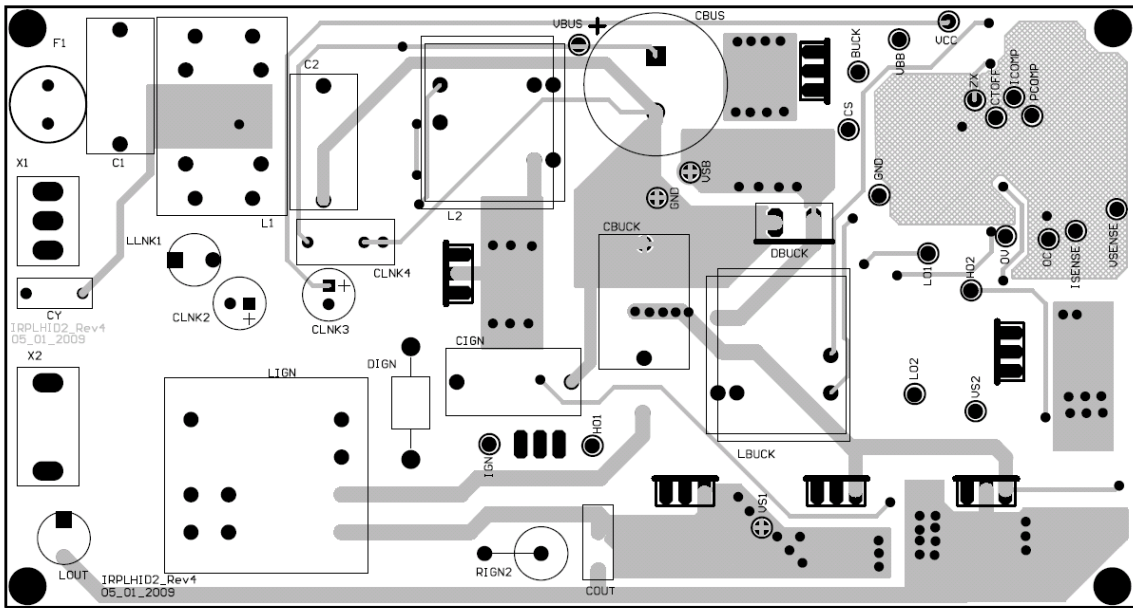

Top Assembly

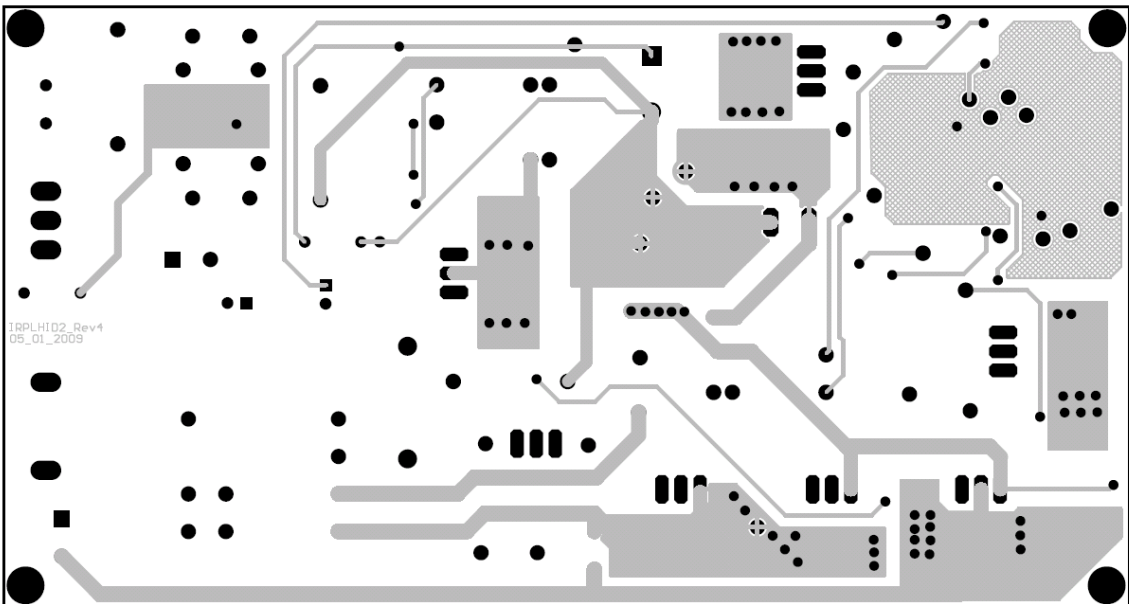

Top Copper

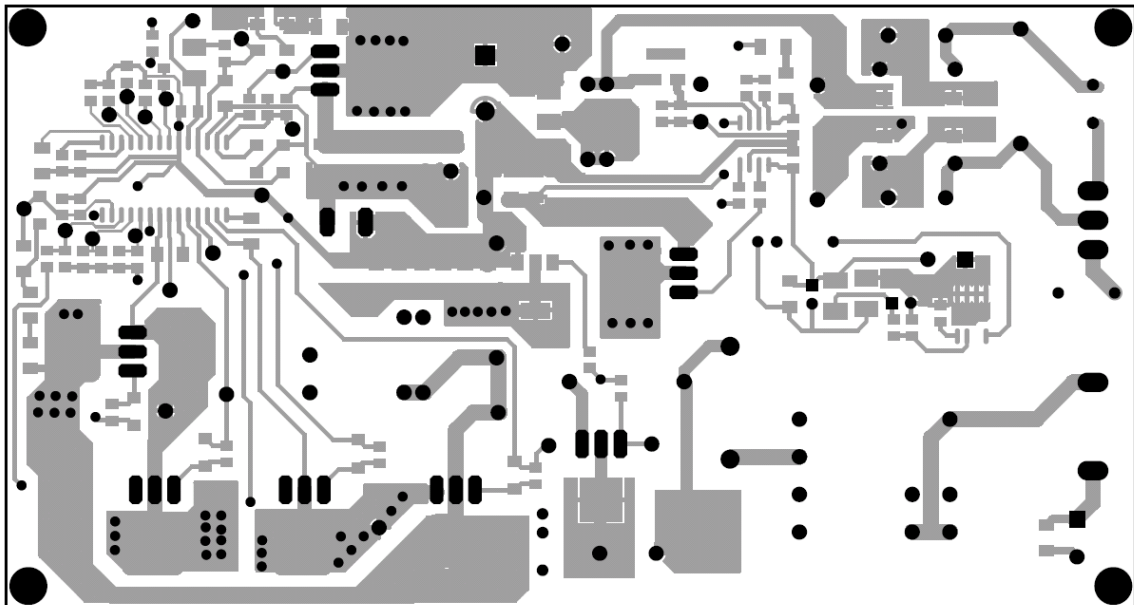
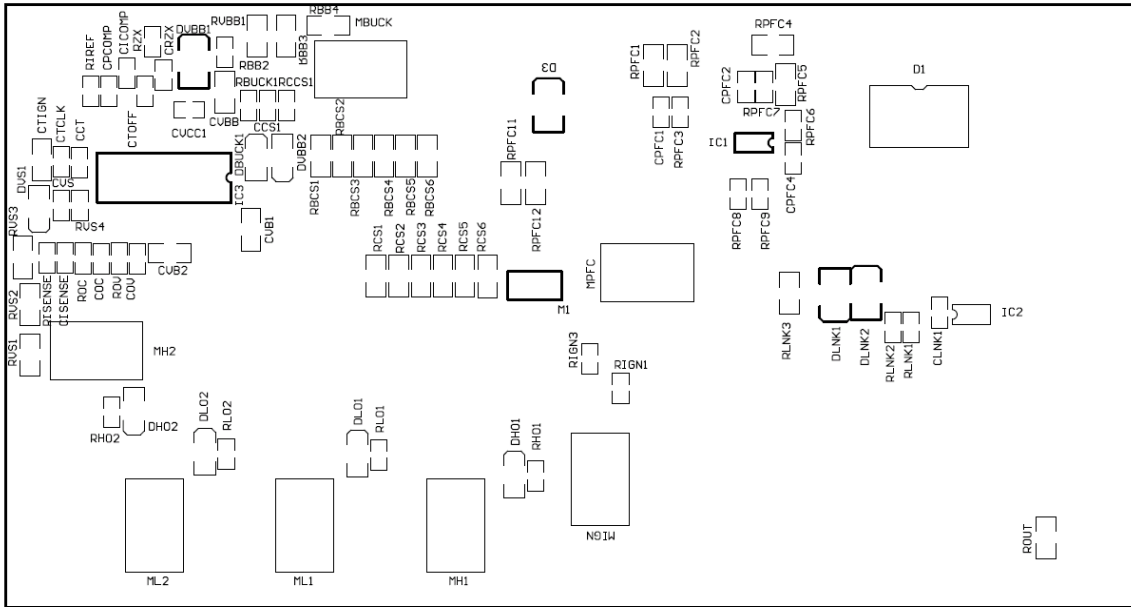

Bottom Copper

11. Inductor specification

Würth Elektronik PN 760801032

CUSTOMER TERMINAL Sn96%, Ag4%	RoHS Yes	LEAD(Pb)-FREE Yes	
----------------------------------	-------------	----------------------	---

PART MUST INSERT FULLY TO SURFACE A IN RECOMMENDED GRID
 .025 SQ.(4) [.64] .110/.126 [2.80/3.20] -A- DOT LOCATES TERM. #1 .827 MAX. [32.58] .780 MAX. [19.81] .827 MAX. [21.00] WÜRTH ELEKTRONIK 760801032

TERM NO.'s FOR REF. ONLY LOT CODE & DATE CODE

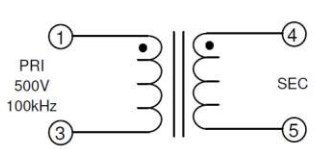

PRI
500V
100kHz

SEC

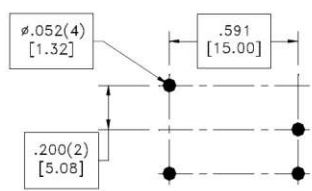

RECOMMENDED
P.C. PATTERN, COMPONENT SIDE

ELECTRICAL SPECIFICATIONS @ 25°C unless otherwise noted:

D.C. RESISTANCE (@20°C):	1-3 , 0.526 Ohms ±10%. 4-5 , 0.539 Ohms ±10%.
DIELECTRIC RATING:	1500VAC, 1 minute tested by applying 1875VAC for 1 second between pins 1-4.
INDUCTANCE:	750.00µH ±10%, 10kHz, 100mVAC, 0mADC, 1-3, Ls.
SATURATION CURRENT:	3.05A saturating current that causes 20% rolloff from initial inductance.
LEAKAGE INDUCTANCE:	55.0µH max., 100kHz, 100mVAC, 1-3(4+5), Ls.
URNS RATIO:	(1-3):(4-5) , (5):(1.00) , ±1%.

OPERATING TEMPERATURE RANGE: -40°C to 125°C including temp. rise.

Wurth Electronics Midcom Inc. Watertown, SD USA Toll Free: 800-643-2661 Fax: 605-886-4486	Unless otherwise specified, tolerances are as follows: Angles: ±1° Fractions: ±1/64 Decimals: ±.005(.127mm) Footprint: ±.001(.03mm)	more than you expect	
	Drawing Title	Drawing Number	Rev.
	Inductor	760801032	00
This drawing is dual dimensioned. Dimensions in brackets are in millimeters	Revisions: See Sheet 1	Scale ----	Spec Sheet 1 of 1
Engineer:RRH		12/07/2012	

Würth Elektronik PN 760801070

CUSTOMER TERMINAL Sn96%, Ag4%	RoHS Yes	LEAD(Pb)-FREE Yes	
----------------------------------	-------------	----------------------	---

PART MUST INSERT FULLY TO SURFACE A IN RECOMMENDED GRID
.025 SQ.(4)
[.64]

.110/.126
[2.80/3.20]

-A-

DOT LOCATES TERM. #1

.827 MAX.
[32.58]

.780 MAX.
[19.81]

.827 MAX.
[21.00]

LOT CODE & DATE CODE

TERM NO.'s FOR REF. ONLY

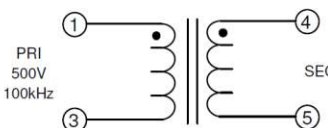

PRI
500V
100kHz

SEC

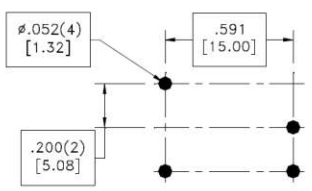

RECOMMENDED
P.C. PATTERN, COMPONENT SIDE

ELECTRICAL SPECIFICATIONS @ 25°C unless otherwise noted:

D.C. RESISTANCE (@20°C): 1-3, 0.492 Ohms ±10%.
4-5, 0.505 Ohms ±10%.

DIELECTRIC RATING: 1500VAC, 1 minute tested by applying 1875VAC for 1 second between pins 1-4.

INDUCTANCE: 1.50 mH ±10%, 10kHz, 100mVAC, 0mADC, 1-3, Ls.

SATURATION CURRENT: 1.2A saturating current that causes 20% rolloff from initial inductance.

LEAKAGE INDUCTANCE: 60.0µH max., 100kHz, 10mVAC, 1-3(4+5), Ls.

URNS RATIO: (1-3):(4-5), (5):(1.00), ±1%.

OPERATING TEMPERATURE RANGE: -40°C to 125°C including temp. rise.

T_0_4969

Würth Electronics Midcom Inc. Watertown, SD USA Toll Free: 800-643-2661 Fax: 605-886-4486	Unless otherwise specified, tolerances are as follows: Angles: ±1° Fractions: ±1/64 Decimals: ±.005(.127mm) Footprint: ±.001(.03mm)	more than you expect
	Drawing Title Inductor	Drawing Number 760801070
This drawing is dual dimensioned. Dimensions in brackets are in millimeters	Revisions: See Sheet 1	Scale ---- Spec Sheet 1 of 1
Engineer:RRH		12/07/2012

Würth Elektronik PN 760370109

CUSTOMER TERMINAL Sn96%, Ag4%	RoHS Yes	LEAD(Pb)-FREE Yes	
----------------------------------	-------------	----------------------	--

* DIMENSION MAY BE EXCEEDED WITH SOLDER ONLY

TAB LOCATES TERM. 1

TERM. NO.'s FOR REF. ONLY

PART MUST INSERT FULLY TO SURFACE A IN RECOMMENDED GRID

LOT CODE & DATE CODE

RECOMMENDED P.C. PATTERN, COMPONENT SIDE

PRI 200-250V 100kHz
SEC 5kV

ELECTRICAL SPECIFICATIONS @ 25°C unless otherwise noted:

D.C. RESISTANCE (@20°C):	2-3 , 0.113 Ohms ±10%.
	1-8 , 0.368 Ohms ±10%.
DIELECTRIC RATING:	2500 VAC for 1 second between pins 1-2.
INDUCTANCE:	1.00 mH ±10%, 10kHz, 100mVAC, 0mADC, 1-8, Ls.
SATURATION CURRENT:	1.475A saturating current that causes 20% rolloff from initial inductance.
LEAKAGE INDUCTANCE:	210.0µH max., 100kHz, 10mVAC, 1-8(2+3), Ls.
TURNS RATIO:	(1-8):(2-3), (20):(1.00), ±2%.

RRH 11/08/12

SP 10/24/12

OPERATING TEMPERATURE RANGE: -40°C to 125°C including temp. rise.

Wire insulation & RoHS status not affected by wire color. Wire insulation color may vary depending on availability. T_0_4722_C_9993

Würth Electronics Midcom Inc. Watertown, SD USA Toll Free: 800-643-2661 Fax: 605-886-4486	Unless otherwise specified, tolerances are as follows: Angles: ±1° Fractions: ±1/64 Decimals: ±.005(.127mm) Footprint: ±.001(.03mm)	more than you expect
	Drawing Title <h2 style="margin: 0;">Transformer</h2>	Drawing Number <h2 style="margin: 0;">760370109</h2>
This drawing is dual dimensioned. Dimensions in brackets are in millimeters	Revisions: See Sheet 1	Scale ---- Spec Sheet 1 of 1

Engineer:RRH 11/08/2012