

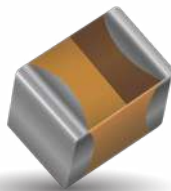

High Reliability Tantalum Capacitors



IMPORTANT INFORMATION/DISCLAIMER

All product specifications, statements, information and data (collectively, the “Information”) in this datasheet or made available on the website are subject to change. The customer is responsible for checking and verifying the extent to which the Information contained in this publication is applicable to an order at the time the order is placed. All Information given herein is believed to be accurate and reliable, but it is presented without guarantee, warranty, or responsibility of any kind, expressed or implied.

Statements of suitability for certain applications are based on KYOCERA AVX’s knowledge of typical operating conditions for such applications, but are not intended to constitute and KYOCERA AVX specifically disclaims any warranty concerning suitability for a specific customer application or use.

ANY USE OF PRODUCT OUTSIDE OF SPECIFICATIONS OR ANY STORAGE OR INSTALLATION INCONSISTENT WITH PRODUCT GUIDANCE VOIDS ANY WARRANTY.

The Information is intended for use only by customers who have the requisite experience and capability to determine the correct products for their application. Any technical advice inferred from this Information or otherwise provided by KYOCERA AVX with reference to the use of KYOCERA AVX’s products is given without regard, and KYOCERA AVX assumes no obligation or liability for the advice given or results obtained.

Although KYOCERA AVX designs and manufactures its products to the most stringent quality and safety standards, given the current state of the art, isolated component failures may still occur. Accordingly, customer applications which require a high degree of reliability or safety should employ suitable designs or other safeguards (such as installation of protective circuitry or redundancies) in order to ensure that the failure of an electrical component does not result in a risk of personal injury or property damage.

Unless specifically agreed to in writing, KYOCERA AVX has not tested or certified its products, services or deliverables for use in high risk applications including medical life support, medical device, direct physical patient contact, water treatment, nuclear facilities, weapon systems, mass and air transportation control, flammable environments, or any other potentially life critical uses. Customer understands and agrees that KYOCERA AVX makes no assurances that the products, services or deliverables are suitable for any high-risk uses. Under no circumstances does KYOCERA AVX warrant or guarantee suitability for any customer design or manufacturing process.

Although all product–related warnings, cautions and notes must be observed, the customer should not assume that all safety measures are indicated or that other measures may not be required.

HIGH RELIABILITY TANTALUM CAPACITORS



Table of Contents

TANTALUM DIVISION

Introduction.....	4
High Reliability Applications.....	5
High Reliability Products.....	6
Military/COTS-Plus/Space Level Surface Mount Products.....	8
Test Options	
High Reliability Specification Requirements Comparison Chart	
Surface Mount Products.....	9
High Reliability Tantalum Chip Product Family - Design Guide	
Part Numbering, Test & Packaging Options	

TAZ SERIES

CWR09 - MIL-PRF-55365/4 Established Reliability, COTS-Plus & Space Level.....	11
CWR19 - MIL-PRF-55365/11 Established Reliability, COTS-Plus & Space Level.....	15
CWR29 - MIL-PRF-55365/11 Established Reliability, COTS-Plus & Space Level.....	19
HRC5000 Medical Implantable Grade.....	25
T4Z HRC4000 Medical Grade for Non-Critical Applications.....	34

TCP SERIES - DLA 09009

Low ESR Tantalum Modules.....	40
-------------------------------	----

TBJ SERIES

CWR11 - MIL-PRF-55365/8 Established Reliability, COTS-Plus & Space Level.....	43
COTS-Plus.....	47
COTS-Plus – Space Level.....	59
DLA Dwg's 07016 & 95158.....	65

T4J SERIES

HRC4000 Implantable Non Life Support and Non Implantable Life Support.....	71
--	----

TBM MULTIANODE

Tantalum Ultra Low ESR Space Level.....	76
Tantalum Ultra Low ESR COTS-Plus.....	79

TBC SERIES

CWR15 MIL-PRF-55365/12 Established Reliability, COTS-Plus & Space Level.....	82
TBC COTS-Plus.....	85
HRC5000 Medical Implantable Grade.....	88
HRC6000 Medical Implantable Grade.....	91
T4C HRC4000 Implantable Non Life Support and Non Implantable Life Support.....	95

TCB SERIES

COTS-Plus Polymer Capacitor.....	98
----------------------------------	----

TCS SERIES

COTS-Plus Polymer Solid Electrolytic Multianode Capacitor.....	102
--	-----

TCD SERIES

DLA 04051 & COTS-Plus.....	105
----------------------------	-----

TCS SERIES - QPL ESCC

Polymer Solid Electrolytic Multianode Capacitor.....	108
--	-----

DLA 93026

Wet Electrolytic Tantalum Capacitor.....	110
--	-----

TWA SERIES

MIL-PRF-39006/33 Series – Military Conventional Wet Tantalum.....	113
COTS-Plus – Wet Electrolytic Tantalum Capacitor.....	115
High Temperature – COTS-Plus 200°C Wet Electrolytic Tantalum Capacitor.....	119
High Temperature – COTS-Plus 230°C Wet Electrolytic Tantalum Capacitor.....	123

TWS ELECTROLYTIC TANTALUM CAPACITOR

DLA 13017.....	126
----------------	-----

TWC SERIES

MIL-PRF-39006 Series – Military Conventional Wet Tantalum.....	128
COTS-Plus – Conventional Wet Tantalum.....	136
High Temperature – COTS-Plus 200°C Wet Tantalum.....	143

TWD HIGH TEMP MAX CAP SERIES.....145

TWM MODULE.....147

TAJ ESCC TANTALUM CAPACITORS

SMD Solid Tantalum Chip Capacitors.....	152
---	-----

TES LOW ESR – QPL ESCC

Low ESR Tantalum Chip Capacitor.....	160
--------------------------------------	-----

TAJ CECC TANTALUM CAPACITORS

SMD Solid Tantalum Chip Capacitors.....	164
---	-----

TCH LOW ESR HERMETIC SERIES

SMD Low ESR Conductive Polymer Capacitors in Hermetic package, COTS-Plus.....	166
---	-----

THH 230°C HERMETIC SERIES

SMD 230°C High Temperature Tantalum Capacitor in Hermetic Package, COTS-Plus.....	170
---	-----

HIGH RELIABILITY TANTALUM MSL

Storage, Bake out, and Handling Recommendations.....	174
--	-----

TAZ COTS+, CWR09, CWR19, CWR29, TAZ HRC5000 AND T4Z SERIES

Tape & Reel Packaging.....	175
----------------------------	-----

TAJ, TBJ, T4J, TBM, TES, TBC, T4C, TCB, TCD AND TCS SERIES

Tape & Reel Packaging.....	176
----------------------------	-----

TANTALUM WET ELECTROLYTIC CAPACITOR

Technical Summary and Application Guide.....	178
--	-----



Introduction

INTRODUCTION

KYOCERA AVX's **Biddeford, Maine** facility is the leading supplier of high reliability tantalum chips to the medical, military and aerospace industry.

As tantalum technology continues to develop, we are able to offer extended ratings in our products by providing more downsizing opportunities, higher capacitance ratings, new case sizes and low ESR options for critical output filtering applications. Combining this with in-line reliability grading capability for all chip capacitor series, we are able to supply these products to the most demanding applications.

AS9100 standardized Quality Management System for the aerospace industry	ISO 9001 fundamental Quality Management System designed to meet regulations & customer needs	ISO 14001 Environmental Management System designed to help improve resource efficiency and reduce waste	ISO 13485 Quality Management System for the design & manufacture of medical devices
MIL-PRF-39006 military performance specification for established & high reliability electrolytic (wet) tantalum capacitors	MIL-PRF-55365 military performance specification for established & high reliability solid tantalum capacitors	MIL-STD-790 established & high reliability QPL standards	

Lanskroun, Czech Republic

TS 16949 Quality Management System for automotive manufacturers & their supply chain	ISO 9001 fundamental Quality Management System designed to meet regulations & customer needs	ISO 14001 Environmental Management System designed to help improve resource efficiency and reduce waste	ESCC 3012 ESA specification for electrical components in space applications
ESCC 3012/001 ESA specification for electrical components in space applications for TAJ style caps	ESCC 3012/004 ESA specification for electrical components in space applications for TES style caps	ESCC 3012/006 ESA specification for electrical components in space applications for TCS style caps	CECC 3081 European military standard for electrical component production

HIGH RELIABILITY TANTALUM

COTS-Plus

Surface Mount MnO ₂ Tantalum	Tantalum Microchip	Wet Tantalum	Solid Electrolytic Polymer
TCP Module Series	TBC Microchip	TWA Series	TCB Series
TAZ Series		TWC Conventional Wet Tantalum	TCS Series
TBJ Series		TWS Series	TCD Series
TBM Multianode		TWM Module	
TAJ CECC Series		TWD Max Cap	
MIL-PRF-55365	MIL-PRF-39006	DLA	DLA CONT.
55365/4 CWR09	CLR79 M39006/22	09009	09009
55365/8 CWR11	CLR81 M39006/25	07016	04051
55365/11 CWR19, 29	CLR90 M39006/30	95158	
55365/12 CWR15 Microchip	CLR91 M39006/31	93026	
	CLR93 M39006/33	13017	

Aerospace

MIL-PRF-55365 "T" Space Level	SRC9000 Space Level	Hermetically Sealed	European Space Components Coordination (ESCC)
55365/4 CWR09	TAZ SRC9000	THH 230°C Hermetic Series	TAJ Series
55365/8 CWR11	TBC Microchip SRC9000	TCH Low ESR Hermetic Series	TES Low ESR
55365/11 CWR19, 29	TBJ SRC9000	TWC SRW9000	TCS Series
55365/12 CWR15 Microchip	TBM SRC9000	TWS SRW9000	
	TCP SRC9000 Module		
Implantable & Life Sustaining	Other Medical Applications		
TBC Microchip HRC6000 Series	T4J HRC4000 Series		
TBC Microchip HRC5000 Series	T4C Microchip HRC4000 Series		
TAZ HRC5000 Series	T4Z HRC4000 Series		

Wet Tantalum	Surface Mount MnO ₂ Tantalum
TWA 200°C Series	THH 230°C Hermetic Series
TWA 230°C Series	
TWC 200°C Conventional	

HIGH RELIABILITY TANTALUM CHIP SPECIFICATIONS

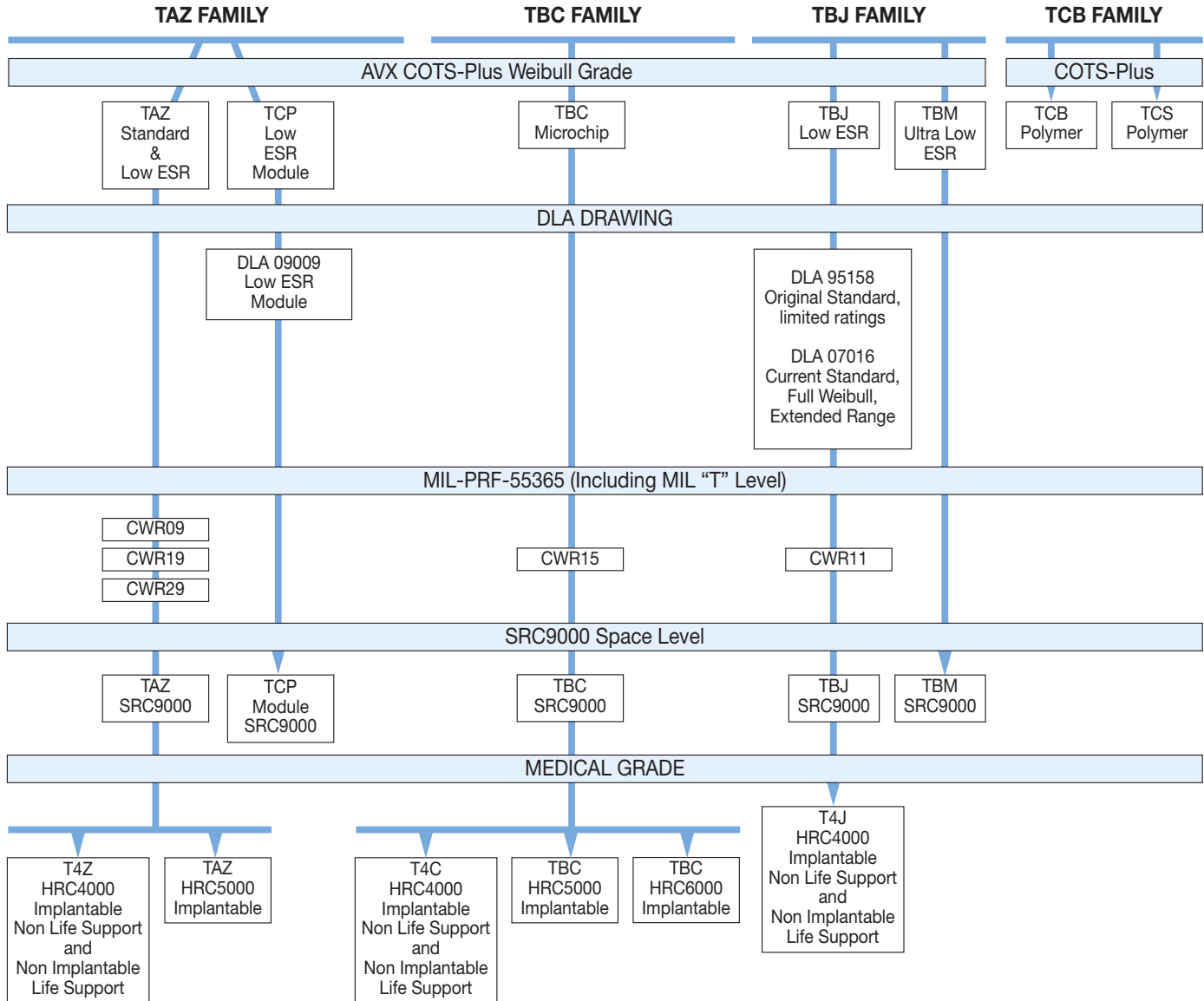

CZECH REPUBLIC HIGH RELIABILITY TANTALUM CHIP SPECIFICATIONS

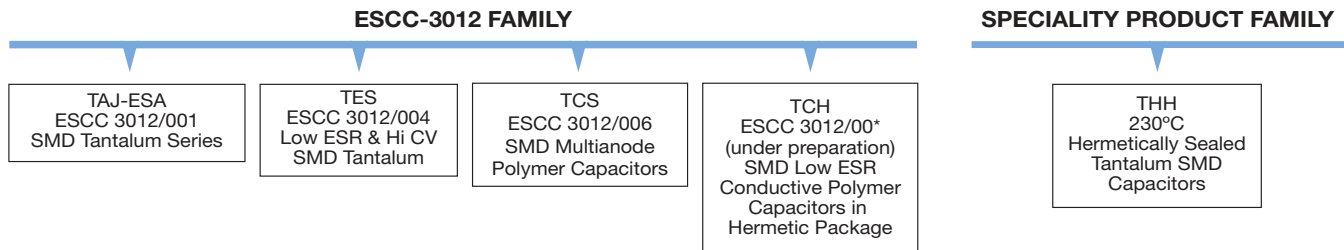

HIGH RELIABILITY WET TANTALUM SPECIFICATIONS

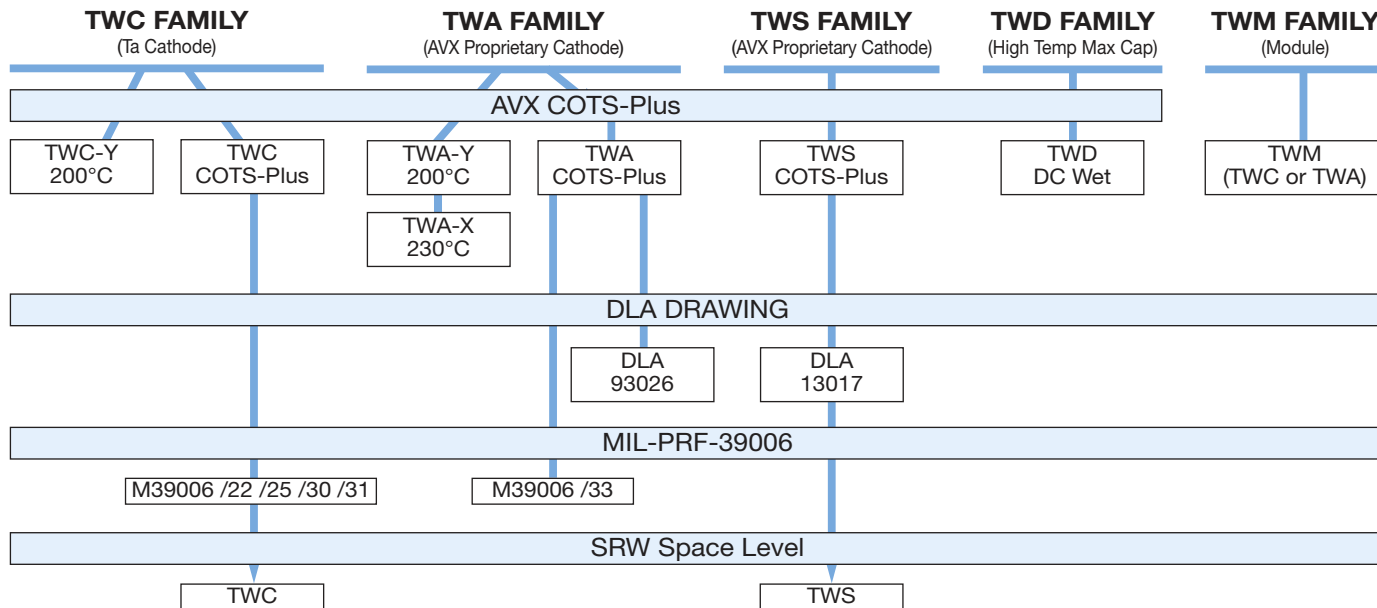

TANTALUM DIVISION

Military/COTS-Plus/Space Level Surface Mount Products



TEST OPTIONS

Test Sequence	Test Method	KYOCERA AVX			
		"T" Level	SRC9+45	9+GC	9+OR**
100% Serialization	TOR-2006(8583)-5236				X
100% Reflow Conditioning	MIL-PRF-55365	X	X	X	X (as SRC9000)
100% Thermal Shock	MIL-PRF-55365	X	X	X	X (as SRC9000)
100% Electrical Verification	TOR-2006(8583)-5236 and MIL-PRF-55365				X
Read and Record Attributes/Variables Data	TOR-2006(8583)-5236				X
100% Surge Current, Option C	MIL-PRF-55365	X	X	X	X
100% Voltage Aging, 40 hours up to at 1.3 Vr	TOR-2006(8583)-5236				X
100% Weibull Grading C	MIL-PRF-55365	X	X	X	X (as SRC9000)
100% Electrical Verification	TOR-2006(8583)-5236 and MIL-PRF-55365				X
Read and Record Attributes/Variables Data	TOR-2006(8583)-5236				X
100% Electrical Verification w/PDA	TOR-2006(8583)-5236				X (5% Surge, VA, Elect. PDA for QPL)
3 Sigma Screening - DF/DCL/ESR Electricals	TOR-2006(8583)-5236 and MIL-PRF-55365	X	X	X	X
Read and Record Attributes/Variables Data	TOR-2006(8583)-5236				X
100% X-ray	MIL-PRF-55365	X			
100% X-ray - 2 Plane	MIL-PRF-55365 and KYOCERA AVX standard		X	X	X
100% Visual/Mechanical Inspection (20x)	MIL-PRF-55365	X	X	X	X
Destructive Physical Analysis (DPA 5 pieces- each lot)	MIL-PRF-55365 or MIL-STD-1580	X	X	X	X
Group B Testing (22 pieces - each lot)	TOR-2006(8583)-5236				X
Temperature Stability - sample	MIL-PRF-55365	X	X	X	X
Solderability - Sample	MIL-PRF-55365	X	X	X	X
Function - Sample	KYOCERA AVX standard		X	X	X (as SRC9000)
Hot DCL - Sample	MIL-PRF-55365		X	X	X (as SRC9000)
Surge Voltage - Sample	MIL-PRF-55365		X	X	X (as SRC9000)
Group C Testing per lot	MIL-PRF-55365	X (SG I,II,III)		X (SG II,III,V)	X (SG II,III,V)
Physical Dimension Verification	MIL-PRF-55365	AQL Sample	AQL Sample	AQL Sample	AQL Sample
Data Pack					
Group A and C Summaries		X (Grp C/lot)	X (Grp C Qtrly)	X (Grp C/lot)	X (Grp C/lot)
2 Plane X-ray JPEG photos					X
DPA Report		X	X	X	X
Attributes / Variables data for Cap/DF/DCL/ESR		X	X	X	X

** TOR Compliant w/SRC9+45 base part

+All are with SnPb terminations.

HIGH RELIABILITY SPECIFICATION REQUIREMENTS COMPARISON CHART

TEST		Series	100% Reflow	Vibration	Shock or Bump	100% Thermal Shock	Resistance to Soldering Heat	Moisture Resistance	Operating Life	100% Weibull	100% Surge Current	100% Electrical Testing	Visual & Mechanical	Simulated Mounting, Rework and Accelerated Life	Solderability Test*	100% X-Ray	DPA - 1580 Destructive Physical Analysis	Surge Voltage	Hot DC Leakage	Temperature Stability	Burn-in 168hrs	Adhesion (shear)	Climatique Sequence ***	
MIL PRF 55365 QPL	Standard MIL	CWR09, 11, 15, 19, 29	0 ■	■ X	0 ■	■ X	■ X	■ X	0 ■	▲	0 ■	0 ■ X			■ X ▲			■ X	0 ■ X					
	New "T" level	CWR09, 11, 15, 19, 29	0 ■	■ X	0 ■	■ X	■ X	0 ■ X	0 ■	0 ■	0 ■	0 ■			■ X ▲	0 ■	0 X	■ X	0 ■ X					
Space Level	SRC9000**	TBJ/TBM (COTS)	0	▲ X	▲ X	0	▲ X	▲ X	(★ 0) ▲ X	0	0	0 ▶	0	0 X	0 X	0	0 X	0 X	0 X	0 X		▲ X		
	SRC9000**	TAZ/TBC/TBJ (MIL)	0 ■	▲ X	▲ X	0 ■	▲ X	▲ X	▲ X	0 ■	0 ■	0 ▶	0 ■	0 X	0 ■ X	0 ■	0 X	0 ■ X	0 ■ X	0 ■ X		▲ X		
COTS-Plus	COTS-Plus**	TBJ/TBM/TAZ	0		0				0	▲	0	0 X			▲ X					▲ X				
	DLA 07016	TBJ	0	▲ X	0	▲ X	▲ X	▲ X	▲	▲	0	0 X			▲ X			▲ X	▲ X					
	DLA 95158	TBJ	0	▲ X	0	▲ X	▲ X	▲ X	▲	▲	0	0 X			▲ X			▲ X	▲ X					
	COTS-Plus	TCS	0	■ X	■ X	■ X			■ X	0	0 ▲	0	0	0 X	0	0	0	0	0 ▲	■ X				
ESA-ESCC 3012	LAT 1	TAJ-ESA, TES, TCS	0 ●	0	0 ●				0		●	0 ●	0	0	0 ●	Level B ●		0	0	0	0	0	0	
	LAT 2		0 ●		●			0		●	0 ●	0	0	0	0 ●	Level B ●		0	0	0	0	0	0	
	LAT 3		0 ●		●			0		●	0 ●	0	0	0	0 ●	Level B ●		0	0	0	0	0	0	0
	NO LAT		0 ●		●			0		●	0 ●	0	0	0	0 ●	Level B ●		0	0	0	0	0	0	0

*Only Mil QPL ratings receive the steam age portion of solderability testing unless otherwise specified by the customer

**Testing of low ESR components requiring a mounted sample shall allow a 2X increase in catalog ESR for post measurements

*** = Dry Heat, Damp Heat, Storage, Low Air Pressure, Damp Heat

- 0 Standard Test
- ▲ Optional Test
- Qualification and or GRP C
- X Sample Test
- ★ COTS Upscreen 1000Hr 125°C
- ▶ KYOCERA AVX Standard DCL/ESR/DF 3 SIGMA
- ◆ DLA Standard DCL/ESR 3 SIGMA
- Part of Manufacturing Flow (PID)
- △ KYOCERA AVX Standard DCL 3 SIGMA

HIGH RELIABILITY TANTALUM CHIP PRODUCT FAMILY - DESIGN GUIDE

TAZ Series
Case Size

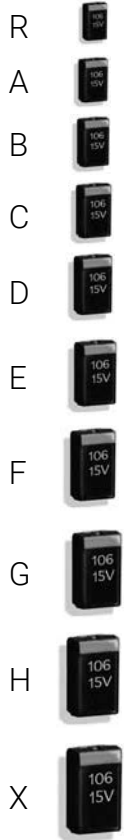

TCP Module

TBC Series
Case Sizes



**TAZ FAMILY SIZES:
CWR09, CWR19, CWR29 and TCP Modules**

The TAZ family boasts the widest range of case sizes and fullest range of MIL-QPL qualifications of any tantalum chip family, making it the ideal choice for the MIL-Aerospace designer.

This family represents the most flexible of surface mount form factors. The case sizes originate from the original MIL chip sizes, enabling support for all legacy programs, but have been extended to include both smaller and larger case size options. There are ten case sizes covering the full Capacitance/Voltage range. Parts are suited to hybrid or PCB assembly, with case sizes A to E designed as low profile (.050" nom).

The Low ESR versions of the larger case sizes are ideally suited to power applications, and the H case is also footprint compatible with TBJ D / E case sizes.

This family is also the ideal replacement for conformal coated CWR06 styles in mechanically demanding applications.

**TBJ FAMILY SIZES:
DLA 95158, 07016 & CWR11; TBM Ultra-Low ESR.**

The TBJ family is based on EIA / Industrial standard sizes. While this series offers a more limited range of form factors (only 4 QPL case sizes, A through D, with an additional 2 case sizes (E & V) available to DLA drawing), it does enable commercial designs / prototypes to be upgraded from commercial to COTS-Plus or even SRC9000 Space level for flight applications.

**TBC FAMILY SIZES:
CWR15**

TBC represents the world's smallest military approved tantalum chip capacitors technology. The case sizes are based on existing small case ceramic chip / resistor chip sizes; L, R & A case are equivalent to 0603, 0805 & 1206 sizes respectively, but with capacitance/voltage combinations significantly higher than available in 125°C rated ceramic devices. TBC represents a significant enabling technology for downsizing and reduced payload circuits for military and aerospace PCB, hybrid & flex circuit applications.

THH 230°C HERMETIC SERIES

Tantalum capacitor in SMD hermetic package for industrial applications like down-hole drilling, avionics and other high temperature, harsh environment application. Operational conditions 230°C/0.5xUr/1000 hrs or 200°C/0.5xUr/10000 hrs. Capacitance range 3.3-330µF, voltage range 16-63V in two case sizes, available with three optional termination designs. Manufactured using KYOCERA AVX patented Q process. Applying for DLA approval.

TCH LOW ESR HERMETIC SERIES

Conductive Polymer in SMD hermetic package for aerospace, HighRel and other industrial applications. 10000hrs endurance at 85°C, 2000 hrs at 125°C. Capacitance range 15 - 680µF, voltage range 10-100V in two case sizes, available with three optional termination designs. Manufactured using KYOCERA AVX patented Q-process. Elektra award winner 2015 (product of the year). Applying for ESCC and DLA approvals

TBJ Series
Case Size

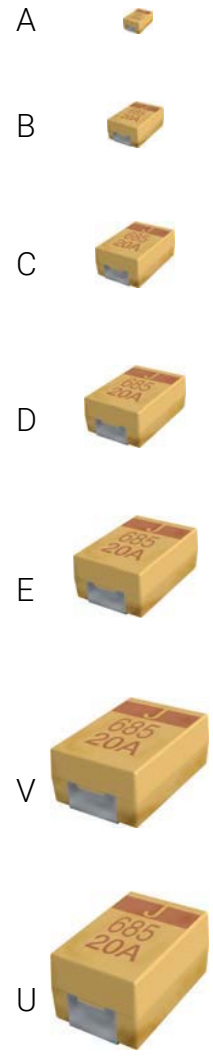

THH & TCH
Case Sizes

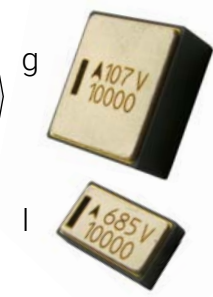

PART NUMBERING, TEST & PACKAGING OPTIONS

Part Numbering:

KYOCERA AVX part numbers have 19 character fields. Standard characters are used to denote KYOCERA AVX series, case size, capacitance code, capacitance tolerance, voltage code and standard / Low ESR designator.

Test Designators:

The following table is a cross-reference between KYOCERA AVX and MIL designators for the various termination, test and inspection options available:

Symbol	Parameter	Condition	Designator	
			MIL	KYOCERA AVX
^	Termination Finish	Hot Solder Dip*	C	8
		Solder Fused	K	0
		Solder Plated	H	H
		Gold	B	9
		Matte Sn	-	7
#	Lot inspection Conformance Level	MIL QPL (JAN brand)	-	M
		DLA Dwg	-	D
		Lab/SCD/SRC9000	-	L
		Standard	-	S
++	Surge Current Test (also used for custom requirements)	No Surge	Z	00
		10 Cycles Ambient	A	23
		10 Cycles -55°C & +85°C	B	24
		10 Cycles -55°C & +85°C Pre-Weibull	C	45
@	Voltage Conditioning (Reliability) Grade	Non ER	A	Z
		B Weibull	B	B
		C Weibull	C	C
		D Weibull	D	D
*	Capacitance Tolerance	±5%	J	J
		±10%	K	K
		±20%	M	M
0	Qualification Level	0 = N/A	N/A	0
		0 = COTS-Plus or Mil 55365	N/A	0
		S = NASA EEE-INST-002		S
		T = M55365 T Level		T
		4 = HRC4000 Medical		4
		5 = HRC5000 Medical		5
		6 = HRC6000 Medical		6
		9 = SRC9000 Space Level		9

*When Hot Solder Dipped terminations are required, add an additional 0.015 inch (0.38 mm) to the tolerances for "L", "H", "P", and a "W2" for each case size.

Packaging Designators:

Due to the wide range of mounting processes that can be used for these products, there are many packaging options including bulk, tape / reel and waffle pack. Full dimensional information and packaging quantities are available in the packaging section (Applications Guide). Custom packaging is available for some product series (e.g. non-modular reel quantities, inverted in waffle (for wire bonding), special bar coding requirements, etc.). Please contact factory for custom requirements.

Symbol	Parameter	Condition	Designator	
			MIL	KYOCERA AVX
☐	Bulk	Bulk	Default	B
		Bulk - ESD Packaging	-	K
	Tape & Reel	4" Reel	\TR4	X
		7" Reel	\TR	R
		13" Reel	\TR13	S
	Waffle Pack	Waffle Pack	\W	W
Waffle - ESD Packaging		\L	L	

TAZ SERIES

CWR09 - MIL-PRF-55365/4 Established Reliability, COTS-Plus & Space Level

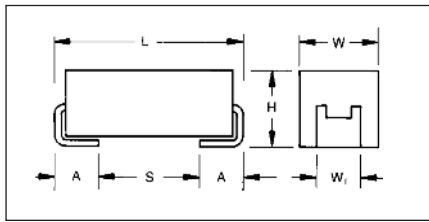

MARKING

(White marking on black body)

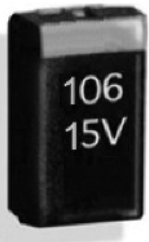

Polarity Stripe (+)

**Capacitance Code
Rated Voltage**

This is the original high reliability molded tantalum chip series and the case sizes still represent the most flexible of surface mount form factors. TAZ offers nine case sizes, eight of which (A through H) are fully qualified to MILPRF-55365/4, and also includes the original sub-miniature R case (non-QPL).

This series is fully interchangeable with CWR06 conformal types, while offering the advantages of molded body/compliant termination construction (ensuring no TCE mismatch with any substrate). This construction is compatible with a wide range of SMT board assembly processes including convection reflow solder, conductive epoxy or compression bonding techniques.

The parts also carry full polarity and capacitance / voltage marking. The five smaller cases are characterized by their low profile construction, with the A case being the world's smallest

molded military tantalum chip.

All 4V to 50V ratings are qualified to MIL-PRF-55365 Weibull "B", "C", "D" and "T" levels, with all surge options ("A", "B" & "C") available.

For Space Level applications, KYOCERA AVXSRC 9000 qualification is recommended (see ratings table for part number availability).

There are four termination finishes available: solder plated, fused solder plated, hot solder dipped and gold plated (these are "H", "K", "C" and "B" termination, respectively, per MIL-PRF-55365). In addition, the molding compound has been selected to meet the requirements of UL 94V-0 (Flame Retardancy) and outgassing requirements of ASTM E-595.

For moisture sensitivity levels please refer to the High Reliability Tantalum MSL section located in the back of the High Reliability Tantalum Catalog.

CASE DIMENSIONS:

millimeters (inches)

Case Code	Length (L) ±0.38 (0.015)	Width (W) ±0.38 (0.015)	Height (H) ±0.38 (0.015)	Term. Width (W _t)	Term. Length (A) +0.25/-0.13 (+0.010/-0.005)	S min	Typical Weight (g)
A	2.54 (0.100)	1.27 (0.050)	1.27 (0.050)	1.27±0.13 (0.050±0.005)	0.76 (0.030)	0.38 (0.015)	0.016
B	3.81 (0.150)	1.27 (0.050)	1.27 (0.050)	1.27±0.13 (0.050±0.005)	0.76 (0.030)	1.65 (0.065)	0.025
C	5.08 (0.200)	1.27 (0.050)	1.27 (0.050)	1.27±0.13 (0.050±0.005)	0.76 (0.030)	2.92 (0.115)	0.035
D	3.81 (0.150)	2.54 (0.100)	1.27 (0.050)	2.41±0.13/-0.25 (0.095+0.005/-0.010)	0.76 (0.030)	1.65 (0.065)	0.045
E	5.08 (0.200)	2.54 (0.100)	1.27 (0.050)	2.41±0.13/-0.25 (0.095+0.005/-0.010)	0.76 (0.030)	2.92 (0.115)	0.065
F	5.59 (0.220)	3.43 (0.135)	1.78 (0.070)	3.30±0.13 (0.130±0.005)	0.76 (0.030)	3.43 (0.135)	0.125
G	6.73 (0.265)	2.79 (0.110)	2.79 (0.110)	2.67±0.13 (0.105±0.005)	1.27 (0.050)	3.56 (0.140)	0.205
H	7.24 (0.285)	3.81 (0.150)	2.79 (0.110)	3.68±0.13/-0.51 (0.145+0.005/-0.020)	1.27 (0.050)	4.06 (0.160)	0.335
R	2.05 (0.081) ±0.20 (0.008)	1.30 (0.051) +0.20 (0.008) -0.10 (0.004)	1.20 (0.047) max	1.0±0.10 (0.039±0.004)	0.50 (0.020) +0.30 (0.012) -0.20 (0.008)	0.71 (0.028)	0.010

CWR09 MIL-PRF-55365/4

CAPACITANCE AND RATED VOLTAGE, V_R (VOLTAGE CODE) RANGE (LETTER DENOTES CASE SIZE)

Capacitance		Rated Voltage DC (V _R) at 85°C							
µF	Code	4V (C)	6V (D)	10V (F)	15V (H)	20V (J)	25V (K)	35V (M)	50V (N)
0.10	104								A
0.15	154								A
0.22	224							A	B
0.33	334	R		R			A		B
0.47	474			R		A		B	C
0.68	684				A	B	B	C	D
1.0	105			A/R		B	C	D	E
1.5	155		A		B	C	D	E	F
2.2	225	A/R		B	C	D	E		F
3.3	335		B	C	D	E		F	G
4.7	475	B	C	D	E		F	G	H
6.8	685	C	D	E		F	G	H	
10	106	D	E		F		G		
15	156	E		F		G	H		
22	226		F		G	H			
33	336	F		G	H				
47	476		G	H					
68	686	G	H						
100	107	H							

TAZ SERIES

CWR09 - MIL-PRF-55365/4 Established Reliability,
COTS-Plus & Space Level



HOW TO ORDER

COTS-PLUS & MIL QPL (CWR09):

TAZ	H	686	*	006	C	□	#	@	0	^	++
Type	Case Size	Capacitance Code pF code: 1st two digits represent significant figures 3rd digit represents multiplier (number of zeros to follow)	Capacitance Tolerance M = ±20% K = ±10% J = ±5%	Voltage Code 004 = 4Vdc 006 = 6Vdc 010 = 10Vdc 015 = 15Vdc 020 = 20Vdc 025 = 25Vdc 035 = 35Vdc 050 = 50Vdc	Standard or Low ESR Range C = Std ESR	Packaging B = Bulk R = 7" T&R S = 13" T&R W = Waffle See page 8 for additional packaging options.	Inspection Level S = Std. Conformance L = Group A M = MIL (JAN) CWR09	Reliability Grade Weibull: B = 0.1%/1000 hrs. 90% conf. C = 0.01%/1000 hrs. 90% conf. D = 0.001%/1000 hrs. 90% conf. Z = Non-ER	Qualification Level 0 = N/A T = T Level 9 = SRC9000	Termination Finish H = Solder Plated 0 = Fused Solder Plated 8 = Hot Solder Dipped 9 = Gold Plated 7 = Matte Sn (COTS-Plus only)	Surge Test Option 00 = None 23 = 10 Cycles, +25°C 24 = 10 Cycles, -55°C & +85°C 45 = 10 cycles, -55°C & +85°C before Weibull

For RoHS compliant products, please select correct termination style.

CWR09 P/N CROSS REFERENCE:

CWR09	D	^	686	*	C	+	□
Type	Voltage Code D = 4Vdc C = 6Vdc F = 10Vdc H = 15Vdc J = 20Vdc K = 25Vdc M = 35Vdc N = 50Vdc	Termination Finish H = Solder Plated K = Solder Fused Dipped C = Hot Solder Dipped B = Gold Plated	Capacitance Code pF code: 1st two digits represent significant figures 3rd digit represents multiplier (number of zeros to follow)	Capacitance Tolerance M = ±20% K = ±10% J = ±5%	Reliability Grade Weibull: B = 0.1%/1000 hrs. 90% conf. C = 0.01%/1000 hrs. 90% conf. D = 0.001%/1000 hrs. 90% conf. T = T Level A = Non-ER	Surge Test Option A = 10 cycles, +25°C B = 10 cycles, -55°C & +85°C C = 10 cycles, -55°C & +85°C before Weibull If blank, None required	Packaging Bulk = Standard TR = 7" T&R TR13 = 13" T&R W = Waffle See page 8 for additional packaging options.

For RoHS compliant products, please select correct termination style.

SPACE LEVEL OPTIONS TO SRC9000*:

TAZ	H	686	*	006	C	□	L	C	9	^	++
Type	Case Size	Capacitance Code pF code: 1st two digits represent significant figures 3rd digit represents multiplier (number of zeros to follow)	Capacitance Tolerance M = ±20% K = ±10% J = ±5%	Voltage Code 004 = 4Vdc 006 = 6Vdc 010 = 10Vdc 015 = 15Vdc 020 = 20Vdc 025 = 25Vdc 035 = 35Vdc 050 = 50Vdc	Standard or Low ESR Range C = Std ESR L = Low ESR	Packaging B = Bulk R = 7" T&R S = 13" T&R W = Waffle See page 8 for additional packaging options.	Inspection Level L = Group A	Reliability Grade Weibull: C = 0.01%/1000 hrs. 90% conf.	Qualification Level 9 = SRC9000	Termination Finish H = Solder Plated 0 = Fused Solder Plated 8 = Hot Solder Dipped 9 = Gold Plated	Surge Test Option 45 = 10 cycles, -55°C & +85°C before Weibull GC = Group C Testing and Data OR = TOR compliant testing and data

For RoHS compliant products, please select correct termination style.

*Contact factory for SRC9000 Space Level SCD details.

TECHNICAL SPECIFICATIONS

Technical Data:	Unless otherwise specified, all technical data relate to an ambient temperature of 25°C									
Capacitance Range:	0.10 µF to 100 µF									
Capacitance Tolerance:	±5%; ±10%; ±20%									
Rated Voltage (V _R)	≤ 85°C:	4	6	10	15	20	25	35	50	
Category Voltage (V _C)	≤ 125°C:	2.7	4	6.7	10	13.3	16.7	23.3	33.3	
Surge Voltage (V _S)	≤ 85°C:	5.3	8	13.3	20	26.7	33.3	46.7	66.7	
Surge Voltage (V _S)	≤ 125°C:	3.5	5.3	8.7	13.3	17.8	22.2	31.1	44.5	
Temperature Range:	-55°C to +125°C									

TAZ SERIES

CWR09 - MIL-PRF-55365/4 Established Reliability,
COTS-Plus & Space Level



RATING & PART NUMBER REFERENCE				Parametric Specifications by Rating per MIL-PRF-55365/4							Typical RMS Ripple Data by Rating								
				Cap @ 120Hz µF @ 25°C	DC Rated Voltage V @ +85°C	ESR @ 100kHz Ohms @ +25°C	DCL max			DF Max			Power Dissipation W	25°C Ripple A (100kHz)	85°C Ripple A (100kHz)	125°C Ripple A (100kHz)	25°C Ripple V (100kHz)	85°C Ripple V (100kHz)	125°C Ripple V (100kHz)
							+25°C (µA)	+85°C (µA)	+125°C (µA)	+25°C (%)	+(85/125) °C (%)	-55°C (%)							
	TAZ R 334 * 004 C □ # @ 0 ^ + +		R	0.33	4	45	1	10	12	6	8	8	0.030	0.03	0.02	0.01	1.16	1.05	0.46
	TAZ R 225 * 004 C □ # @ 0 ^ + +		R	2.2	4	12	1	10	12	6	8	8	0.030	0.05	0.05	0.02	0.60	0.54	0.24
CWR09C^225^@+	TAZ A 225 * 004 C □ # @ 0 ^ + +	TAZ A 225 * 004 C □ L C 9 ^ + +	A	2.2	4	8	1	10	12	6	8	8	0.050	0.08	0.07	0.03	0.63	0.57	0.25
CWR09C^475^@+	TAZ B 475 * 004 C □ # @ 0 ^ + +	TAZ B 475 * 004 C □ L C 9 ^ + +	B	4.7	4	8	1	10	12	6	8	8	0.070	0.09	0.08	0.04	0.75	0.67	0.30
CWR09C^685^@+	TAZ C 685 * 004 C □ # @ 0 ^ + +	TAZ C 685 * 004 C □ L C 9 ^ + +	C	6.8	4	5.5	1	10	12	6	8	8	0.075	0.12	0.11	0.05	0.64	0.58	0.26
CWR09C^106^@+	TAZ D 106 * 004 C □ # @ 0 ^ + +	TAZ D 106 * 004 C □ L C 9 ^ + +	D	10	4	4	1	10	12	8	8	10	0.080	0.14	0.13	0.06	0.57	0.51	0.23
CWR09C^156^@+	TAZ E 156 * 004 C □ # @ 0 ^ + +	TAZ E 156 * 004 C □ L C 9 ^ + +	E	15	4	3.5	1	10	12	8	10	12	0.090	0.16	0.14	0.06	0.56	0.51	0.22
CWR09C^336^@+	TAZ F 336 * 004 C □ # @ 0 ^ + +	TAZ F 336 * 004 C □ L C 9 ^ + +	F	33	4	2.2	2	20	24	8	10	12	0.100	0.21	0.19	0.09	0.47	0.42	0.19
CWR09C^686^@+	TAZ G 686 * 004 C □ # @ 0 ^ + +	TAZ G 686 * 004 C □ L C 9 ^ + +	G	68	4	1.1	3	30	36	10	12	12	0.125	0.34	0.30	0.13	0.37	0.33	0.15
CWR09C^107^@+	TAZ H 107 * 004 C □ # @ 0 ^ + +	TAZ H 107 * 004 C □ L C 9 ^ + +	H	100	4	0.9	4	40	48	10	12	12	0.150	0.41	0.37	0.16	0.37	0.33	0.15
CWR09D^155^@+	TAZ A 155 * 006 C □ # @ 0 ^ + +	TAZ A 155 * 006 C □ L C 9 ^ + +	A	1.5	6	8	1	10	12	6	8	8	0.050	0.08	0.07	0.03	0.63	0.57	0.25
CWR09D^335^@+	TAZ B 335 * 006 C □ # @ 0 ^ + +	TAZ B 335 * 006 C □ L C 9 ^ + +	B	3.3	6	8	1	10	12	6	8	8	0.070	0.09	0.08	0.04	0.75	0.67	0.30
CWR09D^475^@+	TAZ C 475 * 006 C □ # @ 0 ^ + +	TAZ C 475 * 006 C □ L C 9 ^ + +	C	4.7	6	5.5	1	10	12	6	8	8	0.075	0.12	0.11	0.05	0.64	0.58	0.26
CWR09D^685^@+	TAZ D 685 * 006 C □ # @ 0 ^ + +	TAZ D 685 * 006 C □ L C 9 ^ + +	D	6.8	6	4.5	1	10	12	6	8	8	0.080	0.13	0.12	0.05	0.60	0.54	0.24
CWR09D^106^@+	TAZ E 106 * 006 C □ # @ 0 ^ + +	TAZ E 106 * 006 C □ L C 9 ^ + +	E	10	6	3.5	1	10	12	8	10	12	0.090	0.16	0.14	0.06	0.56	0.51	0.22
CWR09D^226^@+	TAZ F 226 * 006 C □ # @ 0 ^ + +	TAZ F 226 * 006 C □ L C 9 ^ + +	F	22	6	2.2	2	20	24	8	10	12	0.100	0.21	0.19	0.09	0.47	0.42	0.19
CWR09D^476^@+	TAZ G 476 * 006 C □ # @ 0 ^ + +	TAZ G 476 * 006 C □ L C 9 ^ + +	G	47	6	1.1	3	30	36	10	12	12	0.125	0.34	0.30	0.13	0.37	0.33	0.15
CWR09D^686^@+	TAZ H 686 * 006 C □ # @ 0 ^ + +	TAZ H 686 * 006 C □ L C 9 ^ + +	H	68	6	0.9	4	40	48	10	12	12	0.150	0.41	0.37	0.16	0.37	0.33	0.15
	TAZ R 334 * 010 C □ # @ 0 ^ + +		R	0.33	10	50	1	10	12	6	8	8	0.030	0.02	0.02	0.01	1.22	1.10	0.49
	TAZ R 474 * 010 C □ # @ 0 ^ + +		R	0.47	10	50	1	10	12	6	8	8	0.030	0.02	0.02	0.01	1.22	1.10	0.49
	TAZ R 105 * 010 C □ # @ 0 ^ + +		R	1	10	10	1	10	12	6	8	8	0.030	0.05	0.05	0.02	0.55	0.49	0.22
CWR09F^105^@+	TAZ A 105 * 010 C □ # @ 0 ^ + +	TAZ A 105 * 010 C □ L C 9 ^ + +	A	1	10	10	1	10	12	6	8	8	0.050	0.07	0.06	0.03	0.71	0.64	0.28
CWR09F^225^@+	TAZ B 225 * 010 C □ # @ 0 ^ + +	TAZ B 225 * 010 C □ L C 9 ^ + +	B	2.2	10	8	1	10	12	6	8	8	0.070	0.09	0.08	0.04	0.75	0.67	0.30
CWR09F^335^@+	TAZ C 335 * 010 C □ # @ 0 ^ + +	TAZ C 335 * 010 C □ L C 9 ^ + +	C	3.3	10	5.5	1	10	12	6	8	8	0.075	0.12	0.11	0.05	0.64	0.58	0.26
CWR09F^475^@+	TAZ D 475 * 010 C □ # @ 0 ^ + +	TAZ D 475 * 010 C □ L C 9 ^ + +	D	4.7	10	4.5	1	10	12	6	8	8	0.080	0.13	0.12	0.05	0.60	0.54	0.24
CWR09F^685^@+	TAZ E 685 * 010 C □ # @ 0 ^ + +	TAZ E 685 * 010 C □ L C 9 ^ + +	E	6.8	10	3.5	1	10	12	6	8	8	0.090	0.16	0.14	0.06	0.56	0.51	0.22
CWR09F^156^@+	TAZ F 156 * 010 C □ # @ 0 ^ + +	TAZ F 156 * 010 C □ L C 9 ^ + +	F	15	10	2.5	2	20	24	8	10	12	0.100	0.20	0.18	0.08	0.50	0.45	0.20
CWR09F^336^@+	TAZ G 336 * 010 C □ # @ 0 ^ + +	TAZ G 336 * 010 C □ L C 9 ^ + +	G	33	10	1.1	3	30	36	10	12	12	0.125	0.34	0.30	0.13	0.37	0.33	0.15
CWR09F^476^@+	TAZ H 476 * 010 C □ # @ 0 ^ + +	TAZ H 476 * 010 C □ L C 9 ^ + +	H	47	10	0.9	5	50	60	10	12	12	0.150	0.41	0.37	0.16	0.37	0.33	0.15
CWR09H^684^@+	TAZ A 684 * 015 C □ # @ 0 ^ + +	TAZ A 684 * 015 C □ L C 9 ^ + +	A	0.68	15	12	1	10	12	6	8	8	0.050	0.06	0.06	0.03	0.77	0.70	0.31
CWR09H^155^@+	TAZ B 155 * 015 C □ # @ 0 ^ + +	TAZ B 155 * 015 C □ L C 9 ^ + +	B	1.5	15	8	1	10	12	6	8	8	0.070	0.09	0.08	0.04	0.75	0.67	0.30
CWR09H^225^@+	TAZ C 225 * 015 C □ # @ 0 ^ + +	TAZ C 225 * 015 C □ L C 9 ^ + +	C	2.2	15	5.5	1	10	12	6	8	8	0.075	0.12	0.11	0.05	0.64	0.58	0.26
CWR09H^335^@+	TAZ D 335 * 015 C □ # @ 0 ^ + +	TAZ D 335 * 015 C □ L C 9 ^ + +	D	3.3	15	5	1	10	12	6	8	8	0.080	0.13	0.11	0.05	0.63	0.57	0.25
CWR09H^475^@+	TAZ E 475 * 015 C □ # @ 0 ^ + +	TAZ E 475 * 015 C □ L C 9 ^ + +	E	4.7	15	4	1	10	12	6	8	8	0.090	0.15	0.14	0.06	0.60	0.54	0.24
CWR09H^106^@+	TAZ F 106 * 015 C □ # @ 0 ^ + +	TAZ F 106 * 015 C □ L C 9 ^ + +	F	10	15	2.5	2	20	24	6	8	8	0.100	0.20	0.18	0.08	0.50	0.45	0.20
CWR09H^226^@+	TAZ G 226 * 015 C □ # @ 0 ^ + +	TAZ G 226 * 015 C □ L C 9 ^ + +	G	22	15	1.1	4	40	48	6	8	8	0.125	0.34	0.30	0.13	0.37	0.33	0.15
CWR09H^336^@+	TAZ H 336 * 015 C □ # @ 0 ^ + +	TAZ H 336 * 015 C □ L C 9 ^ + +	H	33	15	0.9	5	50	60	8	8	10	0.150	0.41	0.37	0.16	0.37	0.33	0.15
CWR09J^474^@+	TAZ A 474 * 020 C □ # @ 0 ^ + +	TAZ A 474 * 020 C □ L C 9 ^ + +	A	0.47	20	14	1	10	12	8	8	10	0.050	0.06	0.05	0.02	0.84	0.75	0.33
CWR09J^684^@+	TAZ B 684 * 020 C □ # @ 0 ^ + +	TAZ B 684 * 020 C □ L C 9 ^ + +	B	0.68	20	10	1	10	12	6	8	8	0.070	0.08	0.08	0.03	0.84	0.75	0.33
CWR09J^105^@+	TAZ B 105 * 020 C □ # @ 0 ^ + +	TAZ B 105 * 020 C □ L C 9 ^ + +	B	1	20	12	1	10	12	6	8	8	0.070	0.08	0.07	0.03	0.92	0.82	0.37
CWR09J^155^@+	TAZ C 155 * 020 C □ # @ 0 ^ + +	TAZ C 155 * 020 C □ L C 9 ^ + +	C	1.5	20	6	1	10	12	6	8	8	0.075	0.11	0.10	0.04	0.67	0.60	0.27
CWR09J^225^@+	TAZ D 225 * 020 C □ # @ 0 ^ + +	TAZ D 225 * 020 C □ L C 9 ^ + +	D	2.2	20	5	1	10	12	6	8	8	0.080	0.13	0.11	0.05	0.63	0.57	0.25
CWR09J^335^@+	TAZ E 335 * 020 C □ # @ 0 ^ + +	TAZ E 335 * 020 C □ L C 9 ^ + +	E	3.3	20	4	1	10	12	6	8	8	0.090	0.15	0.14	0.06	0.60	0.54	0.24
CWR09J^685^@+	TAZ F 685 * 020 C □ # @ 0 ^ + +	TAZ F 685 * 020 C □ L C 9 ^ + +	F	6.8	20	2.4	2	20	24	6	8	8	0.100	0.20	0.18	0.08	0.49	0.44	0.20
CWR09J^156^@+	TAZ G 156 * 020 C □ # @ 0 ^ + +	TAZ G 156 * 020 C □ L C 9 ^ + +	G	15	20	1.1	3	30	36	6	8	8	0.125	0.34	0.30	0.13	0.37	0.33	0.15
CWR09J^226^@+	TAZ H 226 * 020 C □ # @ 0 ^ + +	TAZ H 226 * 020 C □ L C 9 ^ + +	H	22	20	0.9	4	40	48	6	8	8	0.150	0.41	0.37	0.16	0.37	0.33	0.15

All technical data relates to an ambient temperature of +25°C. Capacitance and DF are measured at 120Hz, 0.5V RMS with a maximum DC bias of 2.2 volts. DCL is measured at rated voltage after 5 minutes.

NOTE: KYOCERA AVX reserves the right to supply a higher voltage rating or tighter tolerance part in the same case size, to the same reliability standards.



The Important Information/Disclaimer is incorporated in the catalog where these specifications came from or available online at www.kyocera-avx.com/disclaimer/ by reference and should be reviewed in full before placing any order.

TAZ SERIES

CWR09 - MIL-PRF-55365/4 Established Reliability, COTS-Plus & Space Level



RATING & PART NUMBER REFERENCE				Parametric Specifications by Rating per MIL-PRF-55365/4									Typical RMS Ripple Data by Rating						
				Cap @ 120Hz	DC Rated Voltage	ESR @ 100kHz	DCL max			DF Max			Power Dissipation	25°C Ripple	85°C Ripple	125°C Ripple	25°C Ripple	85°C Ripple	125°C Ripple
							+25°C	+85°C	+125°C	+25°C	+(85/125)°C	-55°C							
CWR09 P/N	MIL & COTS-Plus P/N	SRC9000 P/N	Case	µF @ 25°C	V @ +85°C	Ohms @ +25°C	(µA)	(µA)	(µA)	(%)	(%)	(%)	W	A (100kHz)	A (100kHz)	A (100kHz)	V (100kHz)	V (100kHz)	V (100kHz)
CWR09K^334^@+	TAZ A 334 * 025 C □ # @ 0 ^ ++	TAZ A 334 * 025 C □ L C 9 ^ ++	A	0.33	25	15	1	10	12	6	8	8	0.050	0.06	0.05	0.02	0.87	0.78	0.35
CWR09K^684^@+	TAZ B 684 * 025 C □ # @ 0 ^ ++	TAZ B 684 * 025 C □ L C 9 ^ ++	B	0.68	25	7.5	1	10	12	6	8	8	0.070	0.10	0.09	0.04	0.72	0.65	0.29
CWR09K^105^@+	TAZ C 105 * 025 C □ # @ 0 ^ ++	TAZ C 105 * 025 C □ L C 9 ^ ++	C	1	25	6.5	1	10	12	6	8	8	0.075	0.11	0.10	0.04	0.70	0.63	0.28
CWR09K^155^@+	TAZ D 155 * 025 C □ # @ 0 ^ ++	TAZ D 155 * 025 C □ L C 9 ^ ++	D	1.5	25	6.5	1	10	12	6	8	8	0.080	0.11	0.10	0.04	0.72	0.65	0.29
CWR09K^225^@+	TAZ E 225 * 025 C □ # @ 0 ^ ++	TAZ E 225 * 025 C □ L C 9 ^ ++	E	2.2	25	3.5	1	10	12	6	8	8	0.090	0.16	0.14	0.06	0.56	0.51	0.22
CWR09K^475^@+	TAZ F 475 * 025 C □ # @ 0 ^ ++	TAZ F 475 * 025 C □ L C 9 ^ ++	F	4.7	25	2.5	2	20	24	6	8	8	0.100	0.20	0.18	0.08	0.50	0.45	0.20
CWR09K^685^@+	TAZ G 685 * 025 C □ # @ 0 ^ ++	TAZ G 685 * 025 C □ L C 9 ^ ++	G	6.8	25	1.2	2	20	24	6	8	8	0.125	0.32	0.29	0.13	0.39	0.35	0.15
CWR09K^106^@+	TAZ G 106 * 025 C □ # @ 0 ^ ++	TAZ G 106 * 025 C □ L C 9 ^ ++	G	10	25	1.4	3	30	36	6	8	8	0.125	0.30	0.27	0.12	0.42	0.38	0.17
CWR09K^156^@+	TAZ H 156 * 025 C □ # @ 0 ^ ++	TAZ H 156 * 025 C □ L C 9 ^ ++	H	15	25	1	4	40	48	6	8	8	0.150	0.39	0.35	0.15	0.39	0.35	0.15
CWR09M^224^@+	TAZ A 224 * 035 C # @ 0 ^ ++	TAZ A 224 * 035 C □ L C 9 ^ ++	A	0.22	35	18	1	035	12	6	8	8	0.050	0.05	0.05	0.02	0.95	0.85	0.38
CWR09M^474^@+	TAZ B 474 * 035 C # @ 0 ^ ++	TAZ B 474 * 035 C L C 9 ^ ++	B	0.47	35	10	1	10	12	6	8	8	0.070	0.08	0.08	0.03	0.84	0.75	0.33
CWR09M^684^@+	TAZ C 684 * 035 C # @ 0 ^ ++	TAZ C 684 * 035 C L C 9 ^ ++	C	0.68	35	8	1	10	12	6	8	8	0.075	0.10	0.09	0.04	0.77	0.70	0.31
CWR09M^105^@+	TAZ D 105 * 035 C # @ 0 ^ ++	TAZ D 105 * 035 C L C 9 ^ ++	D	1	35	6.5	1	10	12	6	8	8	0.080	0.11	0.10	0.04	0.72	0.65	0.29
CWR09M^155^@+	TAZ E 155 * 035 C # @ 0 ^ ++	TAZ E 155 * 035 C L C 9 ^ ++	E	1.5	35	4.5	1	10	12	6	8	8	0.090	0.14	0.13	0.06	0.64	0.57	0.25
CWR09M^335^@+	TAZ F 335 * 035 C # @ 0 ^ ++	TAZ F 335 * 035 C L C 9 ^ ++	F	3.3	35	2.5	1	10	12	6	8	8	0.100	0.20	0.18	0.08	0.50	0.45	0.20
CWR09M^475^@+	TAZ G 475 * 035 C # @ 0 ^ ++	TAZ G 475 * 035 C L C 9 ^ ++	G	4.7	35	1.5	2	20	24	6	8	8	0.125	0.29	0.26	0.12	0.43	0.39	0.17
CWR09M^685^@+	TAZ H 685 * 035 C # @ 0 ^ ++	TAZ H 685 * 035 C L C 9 ^ ++	H	6.8	35	1.3	3	30	36	6	8	8	0.150	0.34	0.31	0.14	0.44	0.40	0.18
CWR09N^104^@+	TAZ A 104 * 050 C # @ 0 ^ ++	TAZ A 104 * 050 C L C 9 ^ ++	A	0.1	50	22	1	10	12	6	8	8	0.050	0.05	0.04	0.02	1.05	0.94	0.42
CWR09N^154^@+	TAZ A 154 * 050 C # @ 0 ^ ++	TAZ A 154 * 050 C L C 9 ^ ++	A	0.15	50	17	1	050	12	6	8	8	0.050	0.05	0.05	0.02	0.92	0.83	0.37
CWR09N^224^@+	TAZ B 224 * 050 C # @ 0 ^ ++	TAZ B 224 * 050 C L C 9 ^ ++	B	0.22	50	14	1	10	12	6	8	8	0.070	0.07	0.06	0.03	0.99	0.89	0.40
CWR09N^334^@+	TAZ B 334 * 050 C # @ 0 ^ ++	TAZ B 334 * 050 C L C 9 ^ ++	B	0.33	50	12	1	10	12	6	8	8	0.070	0.08	0.07	0.03	0.92	0.82	0.37
CWR09N^474^@+	TAZ C 474 * 050 C # @ 0 ^ ++	TAZ C 474 * 050 C L C 9 ^ ++	C	0.47	50	8	1	10	12	6	8	8	0.075	0.10	0.09	0.04	0.77	0.70	0.31
CWR09N^684^@+	TAZ D 684 * 050 C # @ 0 ^ ++	TAZ D 684 * 050 C L C 9 ^ ++	D	0.68	50	7	1	10	12	6	8	8	0.080	0.11	0.10	0.04	0.75	0.67	0.30
CWR09N^105^@+	TAZ E 105 * 050 C # @ 0 ^ ++	TAZ E 105 * 050 C L C 9 ^ ++	E	1	50	6	1	10	12	6	8	8	0.090	0.12	0.11	0.05	0.73	0.66	0.29
CWR09N^155^@+	TAZ F 155 * 050 C # @ 0 ^ ++	TAZ F 155 * 050 C L C 9 ^ ++	F	1.5	50	4	1	10	12	6	8	8	0.100	0.16	0.14	0.06	0.63	0.57	0.25
CWR09N^225^@+	TAZ F 225 * 050 C # @ 0 ^ ++	TAZ F 225 * 050 C L C 9 ^ ++	F	2.2	50	2.5	2	20	24	6	8	8	0.100	0.20	0.18	0.08	0.50	0.45	0.20
CWR09N^335^@+	TAZ G 335 * 050 C # @ 0 ^ ++	TAZ G 335 * 050 C L C 9 ^ ++	G	3.3	50	2	2	20	24	6	8	8	0.125	0.25	0.23	0.10	0.50	0.45	0.20
CWR09N^475^@+	TAZ H 475 * 050 C # @ 0 ^ ++	TAZ H 475 * 050 C L C 9 ^ ++	H	4.7	50	1.5	3	30	36	6	8	8	0.150	0.32	0.28	0.13	0.47	0.43	0.19

All technical data relates to an ambient temperature of +25°C. Capacitance and DF are measured at 120Hz, 0.5V RMS with a maximum DC bias of 2.2 volts. DCL is measured at rated voltage after 5 minutes.

NOTE: KYOCERA AVX reserves the right to supply a higher voltage rating or tighter tolerance part in the same case size, to the same reliability standards.

TAZ SERIES



CWR19 - MIL-PRF-55365/11 Established Reliability, COTS-Plus & Space Level



An extended range of capacitor ratings beyond CWR09 that is fully qualified to MIL-PRF-55365/11, this series represents the most flexible of surface mount form factors, offering nine case sizes (the original A through H of CWR09) and adds the new X case size.

The molded body / compliant termination construction ensures no TCE mismatch with any substrate. This construction is compatible with a wide range of SMT board assembly processes including convection reflow solder, conductive epoxy or compression bonding techniques. The parts also carry full polarity and capacitance / voltage marking.

The four smaller cases are characterized by their low profile construction, with the A case being the world's smallest molded military tantalum chip.

The series is qualified to MIL-PRF-55365 Weibull

"B", "C", "D" and "T" levels, with all surge options ("A", "B" & "C") available.

For Space Level applications, SRC 9000 qualification is recommended (see ratings table for part number availability).

There are four termination finishes available: solder plated, fused solder plated, hot solder dipped and gold plated (these are "H", "K", "C" and "B" termination, respectively, per MIL-PRF-55365). In addition, the molding compound has been selected to meet the requirements of UL94V-0 (Flame Retardancy) and outgassing requirements of ASTM E-595.

For moisture sensitivity levels please refer to the High Reliability Tantalum MSL section located in the back of the High Reliability Tantalum Catalog.

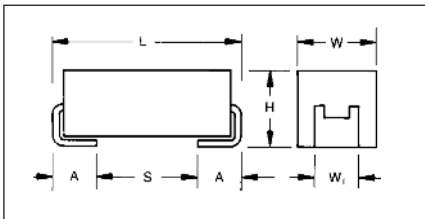

MARKING

(White marking on black body)

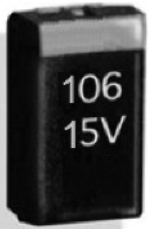

Polarity Stripe (+)
Capacitance Code
Rated Voltage

CASE DIMENSIONS:

millimeters (inches)

Case Code	Length (L) ±0.38 (0.015)	Width (W) ±0.38 (0.015)	Height (H) ±0.38 (0.015)	Term. Width (W _t)	Term. Length (A) +0.25/-0.13 (+0.010/-0.005)	S min	Typical Weight (g)
A	2.54 (0.100)	1.27 (0.050)	1.27 (0.050)	1.27±0.13 (0.050±0.005)	0.76 (0.030)	0.38 (0.015)	0.016
B	3.81 (0.150)	1.27 (0.050)	1.27 (0.050)	1.27±0.13 (0.050±0.005)	0.76 (0.030)	1.65 (0.065)	0.025
C	5.08 (0.200)	1.27 (0.050)	1.27 (0.050)	1.27±0.13 (0.050±0.005)	0.76 (0.030)	2.92 (0.115)	0.035
D	3.81 (0.150)	2.54 (0.100)	1.27 (0.050)	2.41±0.13/-0.25 (0.095±0.005/-0.010)	0.76 (0.030)	1.65 (0.065)	0.045
E	5.08 (0.200)	2.54 (0.100)	1.27 (0.050)	2.41±0.13/-0.25 (0.095±0.005/-0.010)	0.76 (0.030)	2.92 (0.115)	0.065
F	5.59 (0.220)	3.43 (0.135)	1.78 (0.070)	3.30±0.13 (0.130±0.005)	0.76 (0.030)	3.43 (0.135)	0.125
G	6.73 (0.265)	2.79 (0.110)	2.79 (0.110)	2.67±0.13 (0.105±0.005)	1.27 (0.050)	3.56 (0.140)	0.205
H	7.24 (0.285)	3.81 (0.150)	2.79 (0.110)	3.68±0.13/-0.51 (0.145±0.005/-0.020)	1.27 (0.050)	4.06 (0.160)	0.335
X	6.93 (0.273)	5.41 (0.213)	2.74 (0.108)	3.05±0.13 (0.120±0.005)	1.19 (0.047)	3.67 (0.144)	0.420

CWR19-MIL-PRF 55365/11

CAPACITANCE AND RATED VOLTAGE, V_R (VOLTAGE CODE) RANGE (LETTER DENOTES CASE SIZE)

Capacitance		Rated Voltage DC (V _R) at 85°C						
µF	Code	4V (C)	6V (D)	10V (F)	15V (H)	20V (J)	25V (K)	35V (M)
0.33	334							A
0.47	474						A	
0.68	684					A		
1.0	105				A	A	B	
1.5	155				A	B		
2.2	225			A	A	B	D	
3.3	335	A	A	A	B	D	E	
4.7	475	A	A	B/C	B/C/D	E		
6.8	685	A	B	B/C/D	D/E	E	F	G
10	106	B	B	B/C/D/E	D/E	E/F		H
15	156	B	B/D/E	D/E	E/F	F	G	X
22	226	B/D	D/E	E	F	G	G/H	
33	336	D/E	E	F	F/G	H	H/X	
47	476	E	F	F/G	G/H	H/X		
68	686	E	F/G	G	G/H			
100	107	F	G	G/H	H			
150	157	G	G	H/X				
220	227	H	H	H				
330	337	H	H					

HOW TO ORDER

COTS-PLUS & MIL QPL (CWR19):

TAZ	H	227	*	006	C	□	#	@	0	^	++
Type	Case Size	Capacitance Code pF code: 1st two digits represent significant figures 3rd digit represents multiplier (number of zeros to follow)	Capacitance Tolerance M = ±20% K = ±10% J = ±5%	Voltage Code 004 = 4Vdc 006 = 6Vdc 010 = 10Vdc 015 = 15Vdc 020 = 20Vdc 025 = 25Vdc 035 = 35Vdc	Standard or Low ESR Range C = Std ESR	Packaging B = Bulk R = 7" T&R S = 13" T&R W = Waffle See page 8 for additional packaging options.	Inspection Level S = Std. Conformance L = Group A M = MIL (JAN) CWR19	Reliability Grade Weibull: B = 0.1%/1000 hrs. 90% conf. C = 0.01%/1000 hrs. 90% conf. D = 0.001%/1000 hrs. 90% conf. Z = Non-ER	Qualification Level 0 = N/A T = T Level 9 = SRC9000	Termination Finish H = Solder Plated 0 = Fused Solder Plated 8 = Hot Solder Dipped 9 = Gold Plated 7 = Matte Sn (COTS-Plus only)	Surge Test Option 00 = None 23 = 10 Cycles, +25°C 24 = 10 Cycles, -55°C & +85°C 45 = 10 cycles, -55°C & +85°C before Weibull

For RoHS compliant products, please select correct termination style.

CWR19 P/N CROSS REFERENCE:

CWR19	D	^	227	*	C	H	+	□
Type	Voltage Code C = 4Vdc D = 6Vdc F = 10Vdc H = 15Vdc J = 20Vdc K = 25Vdc M = 35Vdc	Termination Finish H = Solder Plated K = Solder Fused C = Hot Solder Dipped B = Gold Plated	Capacitance Code pF code: 1st two digits represent significant figures 3rd digit represents multiplier (number of zeros to follow)	Capacitance Tolerance M = ±20% K = ±10% J = ±5%	Reliability Grade Weibull: B = 0.1%/1000 hrs. 90% conf. C = 0.01%/1000 hrs. 90% conf. D = 0.001%/1000 hrs. 90% conf. T = T Level A = Non-ER	Case Size	Surge Test Option A = 10 cycles, +25°C B = 10 cycles, -55°C & +85°C C = 10 cycles, -55°C & +85°C before Weibull Z = None required	Packaging Bulk = Standard TR = 7" T&R TR13 = 13" T&R W = Waffle See page 8 for additional packaging options.

For RoHS compliant products, please select correct termination style.

SPACE LEVEL OPTIONS TO SRC9000*:

TAZ	H	227	*	006	C	□	L	C	9	^	++
Type	Case Size	Capacitance Code pF code: 1st two digits represent significant figures 3rd digit represents multiplier (number of zeros to follow)	Capacitance Tolerance M = ±20% K = ±10% J = ±5%	Voltage Code 004 = 4Vdc 006 = 6Vdc 010 = 10Vdc 015 = 15Vdc 020 = 20Vdc 025 = 25Vdc 035 = 35Vdc	Standard or Low ESR Range C = Std ESR L = Low ESR	Packaging B = Bulk R = 7" T&R S = 13" T&R W = Waffle See page 8 for additional packaging options.	Inspection Level L = Group A	Reliability Grade Weibull: C = 0.01%/1000 hrs. 90% conf.	Qualification Level 9 = SRC9000	Termination Finish H = Solder Plated 0 = Fused Solder Plated 8 = Hot Solder Dipped 9 = Gold Plated	Surge Test Option 45 = 10 cycles, -55°C & +85°C before Weibull GC = Group C Testing and Data OR = TOR compliant testing and data

For RoHS compliant products, please select correct termination style.

*Contact factory for SRC9000 Space Level SCD details.

TECHNICAL SPECIFICATIONS

Technical Data:	Unless otherwise specified, all technical data relate to an ambient temperature of 25°C								
Capacitance Range:	0.33 μF to 330 μF								
Capacitance Tolerance:	±5%; ±10%; ±20%								
Rated Voltage (V _R)	≤ 85°C:	4	6	10	15	20	25	35	
Category Voltage (V _C)	≤ 125°C:	2.7	4	6.7	10	13.3	16.7	23.3	
Surge Voltage (V _S)	≤ 85°C:	5.3	8	13.3	20	26.7	33.3	46.7	
Surge Voltage (V _S)	≤ 125°C:	3.5	5.3	8.7	13.3	17.8	22.2	31.1	
Temperature Range:	-55°C to +125°C								

TAZ SERIES

CWR19 - MIL-PRF-55365/11 Established Reliability, COTS-Plus & Space Level



RATING & PART NUMBER REFERENCE				Parametric Specifications by Rating per MIL-PRF-55365/4									Typical RMS Ripple Data by Rating									
				Cap@ 120Hz µF@ 25°C	DC Rated Voltage V @ +85°C	ESR @ 100kHz Ohms @ +25°C	DCL max			DF Max			Power Dissipation W	25°C Ripple A (100kHz)	85°C Ripple A (100kHz)	125°C Ripple A (100kHz)	25°C Ripple V (100kHz)	85°C Ripple V (100kHz)	125°C Ripple V (100kHz)			
							+25°C (µA)	+85°C (µA)	+125°C (µA)	+25°C (%)	+85/125°C (%)	-55°C (%)										
CWR09 P/N	MIL & COTS-Plus P/N	SRC9000 P/N	Case																			
CWR19C^335* @A+ □	TAZ A 335 * 004 C □ # @ 0 ^ ++	TAZ A 335 * 004 C □ LC 9 ^ ++	A	3.3	4	12	1	10	12	6	8	8	0.050	0.06	0.06	0.03	0.77	0.70	0.31			
CWR19C^475* @A+ □	TAZ A 475 * 004 C □ # @ 0 ^ ++	TAZ A 475 * 004 C □ LC 9 ^ ++	A	4.7	4	12	1	10	12	6	8	8	0.050	0.06	0.06	0.03	0.77	0.70	0.31			
CWR19C^685* @A+ □	TAZ A 685 * 004 C □ # @ 0 ^ ++	TAZ A 685 * 004 C □ LC 9 ^ ++	A	6.8	4	12	1	10	12	6	8	8	0.050	0.06	0.06	0.03	0.77	0.70	0.31			
CWR19C^106* @B+ □	TAZ B 106 * 004 C □ # @ 0 ^ ++	TAZ B 106 * 004 C □ LC 9 ^ ++	B	10	4	8	1	10	12	8	10	10	0.070	0.09	0.08	0.04	0.75	0.67	0.30			
CWR19C^156* @B+ □	TAZ B 156 * 004 C □ # @ 0 ^ ++	TAZ B 156 * 004 C □ LC 9 ^ ++	B	15	4	8	1	10	12	8	10	10	0.070	0.09	0.08	0.04	0.75	0.67	0.30			
CWR19C^226* @B+ □	TAZ B 226 * 004 C □ # @ 0 ^ ++	TAZ B 226 * 004 C □ LC 9 ^ ++	B	22	4	8	1	10	12	8	10	10	0.070	0.09	0.08	0.04	0.75	0.67	0.30			
CWR19C^226* @D+ □	TAZ D 226 * 004 C □ # @ 0 ^ ++	TAZ D 226 * 004 C □ LC 9 ^ ++	D	22	4	4	1	10	12	8	10	12	0.080	0.14	0.13	0.06	0.57	0.51	0.23			
CWR19C^336* @D+ □	TAZ D 336 * 004 C □ # @ 0 ^ ++	TAZ D 336 * 004 C □ LC 9 ^ ++	D	33	4	4	2	20	24	8	10	12	0.080	0.14	0.13	0.06	0.57	0.51	0.23			
CWR19C^336* @E+ □	TAZ E 336 * 004 C □ # @ 0 ^ ++	TAZ E 336 * 004 C □ LC 9 ^ ++	E	33	4	3	2	20	24	8	10	12	0.090	0.17	0.16	0.07	0.52	0.47	0.21			
CWR19C^476* @E+ □	TAZ E 476 * 004 C □ # @ 0 ^ ++	TAZ E 476 * 004 C □ LC 9 ^ ++	E	47	4	3	2	20	24	8	10	12	0.090	0.17	0.16	0.07	0.52	0.47	0.21			
CWR19C^686* @E+ □	TAZ E 686 * 004 C □ # @ 0 ^ ++	TAZ E 686 * 004 C □ LC 9 ^ ++	E	68	4	3	3	30	36	8	10	12	0.090	0.17	0.16	0.07	0.52	0.47	0.21			
CWR19C^107* @F+ □	TAZ F 107 * 004 C □ # @ 0 ^ ++	TAZ F 107 * 004 C □ LC 9 ^ ++	F	100	4	2	4	40	48	10	12	12	0.100	0.22	0.20	0.09	0.45	0.40	0.18			
CWR19C^157* @G+ □	TAZ G 157 * 004 C □ # @ 0 ^ ++	TAZ G 157 * 004 C □ LC 9 ^ ++	G	150	4	1	6	60	72	10	12	12	0.125	0.35	0.32	0.14	0.35	0.32	0.14			
CWR19C^227* @H+ □	TAZ H 227 * 004 C □ # @ 0 ^ ++	TAZ H 227 * 004 C □ LC 9 ^ ++	H	220	4	1	8	80	96	10	12	12	0.150	0.39	0.35	0.15	0.39	0.35	0.15			
CWR19C^337* @H+ □	TAZ H 337 * 004 C □ # @ 0 ^ ++	TAZ H 337 * 004 C □ LC 9 ^ ++	H	330	4	0.9	10	100	120	10	12	12	0.150	0.41	0.37	0.16	0.37	0.33	0.15			
CWR19D^335* @A+ □	TAZ A 335 * 006 C □ # @ 0 ^ ++	TAZ A 335 * 006 C □ LC 9 ^ ++	A	3.3	6	12	1	10	12	6	8	8	0.050	0.06	0.06	0.03	0.77	0.70	0.31			
CWR19D^475* @A+ □	TAZ A 475 * 006 C □ # @ 0 ^ ++	TAZ A 475 * 006 C □ LC 9 ^ ++	A	4.7	6	12	1	10	12	6	8	8	0.050	0.06	0.06	0.03	0.77	0.70	0.31			
CWR19D^685* @B+ □	TAZ B 685 * 006 C □ # @ 0 ^ ++	TAZ B 685 * 006 C □ LC 9 ^ ++	B	6.8	6	8	1	10	12	6	8	8	0.070	0.09	0.08	0.04	0.75	0.67	0.30			
CWR19D^106* @B+ □	TAZ B 106 * 006 C □ # @ 0 ^ ++	TAZ B 106 * 006 C □ LC 9 ^ ++	B	10	6	8	1	10	12	8	10	10	0.070	0.09	0.08	0.04	0.75	0.67	0.30			
CWR19D^156* @B+ □	TAZ B 156 * 006 C □ # @ 0 ^ ++	TAZ B 156 * 006 C □ LC 9 ^ ++	B	15	6	8	1	10	12	8	10	10	0.070	0.09	0.08	0.04	0.75	0.67	0.30			
CWR19D^156* @D+ □	TAZ D 156 * 006 C □ # @ 0 ^ ++	TAZ D 156 * 006 C □ LC 9 ^ ++	D	15	6	5	1	10	12	8	10	12	0.080	0.13	0.11	0.05	0.63	0.57	0.25			
CWR19D^226* @D+ □	TAZ D 226 * 006 C □ # @ 0 ^ ++	TAZ D 226 * 006 C □ LC 9 ^ ++	D	22	6	5	1	10	12	6	8	8	0.080	0.13	0.11	0.05	0.63	0.57	0.25			
CWR19D^156* @E+ □	TAZ E 156 * 006 C □ # @ 0 ^ ++	TAZ E 156 * 006 C □ LC 9 ^ ++	E	15	6	3	1	10	12	8	10	12	0.090	0.17	0.16	0.07	0.52	0.47	0.21			
CWR19D^226* @E+ □	TAZ E 226 * 006 C □ # @ 0 ^ ++	TAZ E 226 * 006 C □ LC 9 ^ ++	E	22	6	3.5	2	20	24	8	10	12	0.090	0.16	0.14	0.06	0.56	0.51	0.22			
CWR19D^336* @E+ □	TAZ E 336 * 006 C □ # @ 0 ^ ++	TAZ E 336 * 006 C □ LC 9 ^ ++	E	33	6	3.5	2	20	24	6	8	8	0.090	0.16	0.14	0.06	0.56	0.51	0.22			
CWR19D^476* @F+ □	TAZ F 476 * 006 C □ # @ 0 ^ ++	TAZ F 476 * 006 C □ LC 9 ^ ++	F	47	6	3.5	3	30	36	8	10	12	0.100	0.17	0.15	0.07	0.59	0.53	0.24			
CWR19D^686* @F+ □	TAZ F 686 * 006 C □ # @ 0 ^ ++	TAZ F 686 * 006 C □ LC 9 ^ ++	F	68	6	1.5	4	40	48	10	12	12	0.100	0.26	0.23	0.10	0.39	0.35	0.15			
CWR19D^686* @G+ □	TAZ G 686 * 006 C □ # @ 0 ^ ++	TAZ G 686 * 006 C □ LC 9 ^ ++	G	68	6	1	4	40	48	10	12	12	0.125	0.35	0.32	0.14	0.35	0.32	0.14			
CWR19D^107* @G+ □	TAZ G 107 * 006 C □ # @ 0 ^ ++	TAZ G 107 * 006 C □ LC 9 ^ ++	G	100	6	1.1	6	60	72	10	12	12	0.125	0.34	0.30	0.13	0.37	0.33	0.15			
CWR19D^157* @G+ □	TAZ G 157 * 006 C □ # @ 0 ^ ++	TAZ G 157 * 006 C □ LC 9 ^ ++	G	150	6	1.1	10	100	120	10	12	12	0.125	0.34	0.30	0.13	0.37	0.33	0.15			
CWR19D^227* @H+ □	TAZ H 227 * 006 C □ # @ 0 ^ ++	TAZ H 227 * 006 C □ LC 9 ^ ++	H	220	6	0.9	10	100	120	10	12	12	0.150	0.41	0.37	0.16	0.37	0.33	0.15			
CWR19D^337* @H+ □	TAZ H 337 * 006 C □ # @ 0 ^ ++	TAZ H 337 * 006 C □ LC 9 ^ ++	H	330	6	0.9	20	200	240	10	12	12	0.150	0.41	0.37	0.16	0.37	0.33	0.15			
CWR19F^225* @A+ □	TAZ A 225 * 010 C □ # @ 0 ^ ++	TAZ A 225 * 010 C □ LC 9 ^ ++	A	2.2	10	12	1	10	12	6	8	8	0.050	0.06	0.06	0.03	0.77	0.70	0.31			
CWR19F^335* @A+ □	TAZ A 335 * 010 C □ # @ 0 ^ ++	TAZ A 335 * 010 C □ LC 9 ^ ++	A	3.3	10	12	1	10	12	6	8	8	0.050	0.06	0.06	0.03	0.77	0.70	0.31			
CWR19F^475* @B+ □	TAZ B 475 * 010 C □ # @ 0 ^ ++	TAZ B 475 * 010 C □ LC 9 ^ ++	B	4.7	10	8	1	10	12	6	8	8	0.070	0.09	0.08	0.04	0.75	0.67	0.30			
CWR19F^685* @B+ □	TAZ B 685 * 010 C □ # @ 0 ^ ++	TAZ B 685 * 010 C □ LC 9 ^ ++	B	6.8	10	8	1	10	12	6	8	8	0.070	0.09	0.08	0.04	0.75	0.67	0.30			
CWR19F^106* @B+ □	TAZ B 106 * 010 C □ # @ 0 ^ ++	TAZ B 106 * 010 C □ LC 9 ^ ++	B	10	10	8	1	10	12	8	10	10	0.070	0.09	0.08	0.04	0.75	0.67	0.30			
CWR19F^475* @C+ □	TAZ C 475 * 010 C □ # @ 0 ^ ++	TAZ C 475 * 010 C □ LC 9 ^ ++	C	4.7	10	5.5	1	10	12	6	8	8	0.075	0.12	0.11	0.05	0.64	0.58	0.26			
CWR19F^685* @C+ □	TAZ C 685 * 010 C □ # @ 0 ^ ++	TAZ C 685 * 010 C □ LC 9 ^ ++	C	6.8	10	5.5	1	10	12	6	8	8	0.075	0.12	0.11	0.05	0.64	0.58	0.26			
CWR19F^106* @C+ □	TAZ C 106 * 010 C □ # @ 0 ^ ++	TAZ C 106 * 010 C □ LC 9 ^ ++	C	10	10	5.5	1	10	12	6	8	8	0.075	0.12	0.11	0.05	0.64	0.58	0.26			
CWR19F^685* @D+ □	TAZ D 685 * 010 C □ # @ 0 ^ ++	TAZ D 685 * 010 C □ LC 9 ^ ++	D	6.8	10	5	1	10	12	6	8	8	0.080	0.13	0.11	0.05	0.63	0.57	0.25			
CWR19F^106* @D+ □	TAZ D 106 * 010 C □ # @ 0 ^ ++	TAZ D 106 * 010 C □ LC 9 ^ ++	D	10	10	4	1	10	12	6	8	8	0.080	0.14	0.13	0.06	0.57	0.51	0.23			
CWR19F^156* @D+ □	TAZ D 156 * 010 C □ # @ 0 ^ ++	TAZ D 156 * 010 C □ LC 9 ^ ++	D	15	10	5	2	20	24	6	8	8	0.080	0.13	0.11	0.05	0.63	0.57	0.25			
CWR19F^106* @E+ □	TAZ E 106 * 010 C □ # @ 0 ^ ++	TAZ E 106 * 010 C □ LC 9 ^ ++	E	10	10	3.5	1	10	12	6	8	8	0.090	0.16	0.14	0.06	0.56	0.51	0.22			
CWR19F^156* @E+ □	TAZ E 156 * 010 C □ # @ 0 ^ ++	TAZ E 156 * 010 C □ LC 9 ^ ++	E	15	10	3	2	20	24	8	10	10	0.090	0.17	0.16	0.07	0.52	0.47	0.21			
CWR19F^226* @E+ □	TAZ E 226 * 010 C □ # @ 0 ^ ++	TAZ E 226 * 010 C □ LC 9 ^ ++	E	22	10	2	3	30	36	8	10	10	0.090	0.21	0.19	0.08	0.42	0.38	0.17			
CWR19F^336* @F+ □	TAZ F 336 * 010 C □ # @ 0 ^ ++	TAZ F 336 * 010 C □ LC 9 ^ ++	F	33	10	1.5	3	30	36	8	10	10	0.100	0.26	0.23	0.10	0.39	0.35	0.15			
CWR19F^476* @F+ □	TAZ F 476 * 010 C □ # @ 0 ^ ++	TAZ F 476 * 010 C □ LC 9 ^ ++	F	47	10	1.5	4	40	48	10	12	12	0.100	0.26	0.23	0.10	0.39	0.35	0.15			
CWR19F^476* @G+ □	TAZ G 476 * 010 C □ # @ 0 ^ ++	TAZ G 476 * 010 C □ LC 9 ^ ++	G	47	10	1	4	40	48	10	12	12	0.125	0.35	0.32	0.14	0.35	0.32	0.14			
CWR19F^686* @G+ □	TAZ G 686 * 010 C □ # @ 0 ^ ++	TAZ G 686 * 010 C □ LC 9 ^ ++	G	68	10	1.1	6	60	72	10	12	12	0.125	0.34	0.30	0.13	0.37	0.33	0.15			
CWR19F^107* @G+ □	TAZ G 107 * 010 C □ # @ 0 ^ ++	TAZ G 107 * 010 C □ LC 9 ^ ++	G	100	10	1.1	10	100	120	10	12	12	0.125	0.34	0.30	0.13	0.37	0.33	0.15			
CWR19F^107* @H+ □	TAZ H 107 * 010 C □ # @ 0 ^ ++	TAZ H 107 * 010 C □ LC 9 ^ ++	H	100	10	0.9	10	100	120	10	12	12	0.150	0.41	0.37	0.16	0.37	0.33	0.15			

All technical data relates to an ambient temperature of +25°C. Capacitance and DF are measured at 120Hz, 0.5V RMS with a maximum DC bias of 2.2 volts. DCL is measured at rated voltage after 5 minutes.

NOTE: KYOCERA AVX reserves the right to supply a higher voltage rating or tighter tolerance part in the same case size, to the same reliability standards.



The Important Information/Disclaimer is incorporated in the catalog where these specifications came from or available online at www.kyocera-avx.com/disclaimer/ by reference and should be reviewed in full before placing any order.

TAZ SERIES

CWR19 - MIL-PRF-55365/11 Established Reliability, COTS-Plus & Space Level



RATING & PART NUMBER REFERENCE				Parametric Specifications by Rating per MIL-PRF-55365/4									Typical RMS Ripple Data by Rating						
				Cap@120Hz	DC Rated Voltage	ESR @ 100kHz	DCL max			DF Max			Power Dissipation	25°C Ripple	85°C Ripple	125°C Ripple	25°C Ripple	85°C Ripple	125°C Ripple
				μF@25°C	V @ +85°C	Ohms @ +25°C	+25°C (μA)	+85°C (μA)	+125°C (μA)	+25°C (%)	+85/125°C (%)	-55°C (%)	W	A (100kHz)	V (100kHz)	A (100kHz)	V (100kHz)	A (100kHz)	V (100kHz)
CWR19F^157^@H+□	TAZ H 157 * 010 C □ # @ 0 ^ ++	TAZ H 157 * 010 C □ L C 9 ^ ++	H	150	10	0.9	15	150	180	10	12	12	0.150	0.41	0.37	0.16	0.37	0.33	0.15
CWR19F^227^@H+□	TAZ H 227 * 010 C □ # @ 0 ^ ++	TAZ H 227 * 010 C □ L C 9 ^ ++	H	220	10	0.9	20	200	240	10	12	12	0.150	0.41	0.37	0.16	0.37	0.33	0.15
CWR19H^157^@X+□	TAZ X 157 * 010 C □ # @ 0 ^ ++	TAZ X 157 * 010 C □ L C 9 ^ ++	X	150	10	0.9	15	150	180	10	12	12	0.200	0.47	0.42	0.19	0.42	0.38	0.17
CWR19H^105^@A+□	TAZ A 105 * 015 C □ # @ 0 ^ ++	TAZ A 105 * 015 C □ L C 9 ^ ++	A	1	15	15	1	10	12	6	8	8	0.050	0.06	0.05	0.02	0.87	0.78	0.35
CWR19H^155^@A+□	TAZ A 155 * 015 C □ # @ 0 ^ ++	TAZ A 155 * 015 C □ L C 9 ^ ++	A	1.5	15	15	1	10	12	6	8	8	0.050	0.06	0.05	0.02	0.87	0.78	0.35
CWR19H^225^@A+□	TAZ A 225 * 015 C □ # @ 0 ^ ++	TAZ A 225 * 015 C □ L C 9 ^ ++	A	2.2	15	15	1	10	12	6	8	8	0.050	0.06	0.05	0.02	0.87	0.78	0.35
CWR19H^335^@B+□	TAZ B 335 * 015 C □ # @ 0 ^ ++	TAZ B 335 * 015 C □ L C 9 ^ ++	B	3.3	15	9	1	10	12	6	8	8	0.070	0.09	0.08	0.04	0.79	0.71	0.32
CWR19H^475^@B+□	TAZ B 475 * 015 C □ # @ 0 ^ ++	TAZ B 475 * 015 C □ L C 9 ^ ++	B	4.7	15	5	1	10	12	6	8	8	0.070	0.12	0.11	0.05	0.59	0.53	0.24
CWR19H^475^@C+□	TAZ C 475 * 015 C □ # @ 0 ^ ++	TAZ C 475 * 015 C □ L C 9 ^ ++	C	4.7	15	5.5	1	10	12	6	8	8	0.075	0.12	0.11	0.05	0.64	0.58	0.26
CWR19H^475^@D+□	TAZ D 475 * 015 C □ # @ 0 ^ ++	TAZ D 475 * 015 C □ L C 9 ^ ++	D	4.7	15	6	1	10	12	6	8	8	0.080	0.12	0.10	0.05	0.69	0.62	0.28
CWR19H^685^@D+□	TAZ D 685 * 015 C □ # @ 0 ^ ++	TAZ D 685 * 015 C □ L C 9 ^ ++	D	6.8	15	6	1	10	12	6	8	8	0.080	0.12	0.10	0.05	0.69	0.62	0.28
CWR19H^106^@D+□	TAZ D 106 * 015 C □ # @ 0 ^ ++	TAZ D 106 * 015 C □ L C 9 ^ ++	D	10	15	6	2	20	24	6	8	8	0.080	0.12	0.10	0.05	0.69	0.62	0.28
CWR19H^685^@E+□	TAZ E 685 * 015 C □ # @ 0 ^ ++	TAZ E 685 * 015 C □ L C 9 ^ ++	E	6.8	15	3	1	10	12	6	8	10	0.090	0.17	0.16	0.07	0.52	0.47	0.21
CWR19H^106^@E+□	TAZ E 106 * 015 C □ # @ 0 ^ ++	TAZ E 106 * 015 C □ L C 9 ^ ++	E	10	15	4	2	20	24	6	8	8	0.090	0.15	0.14	0.06	0.60	0.54	0.24
CWR19H^156^@E+□	TAZ E 156 * 015 C □ # @ 0 ^ ++	TAZ E 156 * 015 C □ L C 9 ^ ++	E	15	15	4	2	20	24	6	8	8	0.090	0.15	0.14	0.06	0.60	0.54	0.24
CWR19H^156^@F+□	TAZ F 156 * 015 C □ # @ 0 ^ ++	TAZ F 156 * 015 C □ L C 9 ^ ++	F	15	15	3	2	20	24	8	10	10	0.100	0.18	0.16	0.07	0.55	0.49	0.22
CWR19H^226^@F+□	TAZ F 226 * 015 C □ # @ 0 ^ ++	TAZ F 226 * 015 C □ L C 9 ^ ++	F	22	15	3	3	30	36	8	10	10	0.100	0.18	0.16	0.07	0.55	0.49	0.22
CWR19H^336^@F+□	TAZ F 336 * 015 C □ # @ 0 ^ ++	TAZ F 336 * 015 C □ L C 9 ^ ++	F	33	15	3	5	50	60	6	8	8	0.100	0.18	0.16	0.07	0.55	0.49	0.22
CWR19H^336^@G+□	TAZ G 336 * 015 C □ # @ 0 ^ ++	TAZ G 336 * 015 C □ L C 9 ^ ++	G	33	15	1.1	6	60	72	8	10	10	0.125	0.34	0.30	0.13	0.37	0.33	0.15
CWR19H^476^@G+□	TAZ G 476 * 015 C □ # @ 0 ^ ++	TAZ G 476 * 015 C □ L C 9 ^ ++	G	47	15	1.1	10	100	120	8	10	10	0.125	0.34	0.30	0.13	0.37	0.33	0.15
CWR19H^686^@G+□	TAZ G 686 * 015 C □ # @ 0 ^ ++	TAZ G 686 * 015 C □ L C 9 ^ ++	G	68	15	1.1	10	100	120	8	10	10	0.125	0.34	0.30	0.13	0.37	0.33	0.15
CWR19H^476^@H+□	TAZ H 476 * 015 C □ # @ 0 ^ ++	TAZ H 476 * 015 C □ L C 9 ^ ++	H	47	15	0.9	10	100	120	8	10	10	0.150	0.41	0.37	0.16	0.37	0.33	0.15
CWR19H^686^@H+□	TAZ H 686 * 015 C □ # @ 0 ^ ++	TAZ H 686 * 015 C □ L C 9 ^ ++	H	68	15	0.9	10	100	120	8	10	10	0.150	0.41	0.37	0.16	0.37	0.33	0.15
CWR19H^107^@H+□	TAZ H 107 * 015 C □ # @ 0 ^ ++	TAZ H 107 * 015 C □ L C 9 ^ ++	H	100	15	0.9	15	150	180	10	12	12	0.150	0.41	0.37	0.16	0.37	0.33	0.15
CWR19J^684^@A+□	TAZ A 684 * 020 C □ # @ 0 ^ ++	TAZ A 684 * 020 C □ L C 9 ^ ++	A	0.68	20	15	1	10	12	6	8	8	0.050	0.06	0.05	0.02	0.87	0.78	0.35
CWR19J^105^@A+□	TAZ A 105 * 020 C □ # @ 0 ^ ++	TAZ A 105 * 020 C □ L C 9 ^ ++	A	1	20	15	1	10	12	6	8	8	0.050	0.06	0.05	0.02	0.87	0.78	0.35
CWR19J^155^@B+□	TAZ B 155 * 020 C □ # @ 0 ^ ++	TAZ B 155 * 020 C □ L C 9 ^ ++	B	1.5	20	9	1	10	12	6	8	8	0.070	0.09	0.08	0.04	0.79	0.71	0.32
CWR19J^225^@B+□	TAZ B 225 * 020 C □ # @ 0 ^ ++	TAZ B 225 * 020 C □ L C 9 ^ ++	B	2.2	20	9	1	10	12	6	8	8	0.070	0.09	0.08	0.04	0.79	0.71	0.32
CWR19J^335^@D+□	TAZ D 335 * 020 C □ # @ 0 ^ ++	TAZ D 335 * 020 C □ L C 9 ^ ++	D	3.3	20	6	1	10	12	6	8	8	0.080	0.12	0.10	0.05	0.69	0.62	0.28
CWR19J^475^@E+□	TAZ E 475 * 020 C □ # @ 0 ^ ++	TAZ E 475 * 020 C □ L C 9 ^ ++	E	4.7	20	6	1	10	12	6	8	8	0.090	0.12	0.11	0.05	0.73	0.66	0.29
CWR19J^685^@E+□	TAZ E 685 * 020 C □ # @ 0 ^ ++	TAZ E 685 * 020 C □ L C 9 ^ ++	E	6.8	20	5	2	20	24	6	8	8	0.090	0.13	0.12	0.05	0.67	0.60	0.27
CWR19J^106^@E+□	TAZ E 106 * 020 C □ # @ 0 ^ ++	TAZ E 106 * 020 C □ L C 9 ^ ++	E	10	20	4	6	60	72	6	8	8	0.090	0.13	0.12	0.05	0.67	0.60	0.27
CWR19J^106^@F+□	TAZ F 106 * 020 C □ # @ 0 ^ ++	TAZ F 106 * 020 C □ L C 9 ^ ++	F	10	20	3	2	20	24	6	8	8	0.100	0.18	0.16	0.07	0.55	0.49	0.22
CWR19J^156^@F+□	TAZ F 156 * 020 C □ # @ 0 ^ ++	TAZ F 156 * 020 C □ L C 9 ^ ++	F	15	20	3	3	30	36	6	8	8	0.100	0.18	0.16	0.07	0.55	0.49	0.22
CWR19J^226^@G+□	TAZ G 226 * 020 C □ # @ 0 ^ ++	TAZ G 226 * 020 C □ L C 9 ^ ++	G	22	20	2.5	4	40	48	6	8	8	0.125	0.22	0.20	0.09	0.56	0.50	0.22
CWR19J^336^@H+□	TAZ H 336 * 020 C □ # @ 0 ^ ++	TAZ H 336 * 020 C □ L C 9 ^ ++	H	33	20	0.9	6	60	72	8	10	10	0.150	0.41	0.37	0.16	0.37	0.33	0.15
CWR19J^476^@H+□	TAZ H 476 * 020 C □ # @ 0 ^ ++	TAZ H 476 * 020 C □ L C 9 ^ ++	H	47	20	0.9	10	100	120	8	10	10	0.150	0.41	0.37	0.16	0.37	0.33	0.15
CWR19J^476^@X+□	TAZ X 476 * 020 C □ # @ 0 ^ ++	TAZ X 476 * 020 C □ L C 9 ^ ++	X	47	20	0.9	10	100	120	8	10	10	0.200	0.47	0.42	0.19	0.42	0.38	0.17
CWR19K^474^@A+□	TAZ A 474 * 025 C □ # @ 0 ^ ++	TAZ A 474 * 025 C □ L C 9 ^ ++	A	0.47	25	15	1	10	12	6	8	8	0.050	0.06	0.05	0.02	0.87	0.78	0.35
CWR19K^105^@B+□	TAZ B 105 * 025 C □ # @ 0 ^ ++	TAZ B 105 * 025 C □ L C 9 ^ ++	B	1	25	10	1	10	12	6	8	8	0.070	0.08	0.08	0.03	0.84	0.75	0.33
CWR19K^225^@D+□	TAZ D 225 * 025 C □ # @ 0 ^ ++	TAZ D 225 * 025 C □ L C 9 ^ ++	D	2.2	25	6	1	10	12	6	8	8	0.080	0.12	0.10	0.05	0.69	0.62	0.28
CWR19K^335^@E+□	TAZ E 335 * 025 C □ # @ 0 ^ ++	TAZ E 335 * 025 C □ L C 9 ^ ++	E	3.3	25	4	1	10	12	6	8	8	0.090	0.15	0.14	0.06	0.60	0.54	0.24
CWR19K^685^@F+□	TAZ F 685 * 025 C □ # @ 0 ^ ++	TAZ F 685 * 025 C □ L C 9 ^ ++	F	6.8	25	3	2	20	24	6	8	8	0.100	0.18	0.16	0.07	0.55	0.49	0.22
CWR19K^156^@G+□	TAZ G 156 * 025 C □ # @ 0 ^ ++	TAZ G 156 * 025 C □ L C 9 ^ ++	G	15	25	1.4	4	40	48	6	8	8	0.125	0.30	0.27	0.12	0.42	0.38	0.17
CWR19K^226^@G+□	TAZ G 226 * 025 C □ # @ 0 ^ ++	TAZ G 226 * 025 C □ L C 9 ^ ++	G	22	25	1.4	6	60	72	6	8	8	0.125	0.30	0.27	0.12	0.42	0.38	0.17
CWR19K^226^@H+□	TAZ H 226 * 025 C □ # @ 0 ^ ++	TAZ H 226 * 025 C □ L C 9 ^ ++	H	22	25	0.9	6	60	72	6	8	8	0.150	0.41	0.37	0.16	0.37	0.33	0.15
CWR19K^336^@H+□	TAZ H 336 * 025 C □ # @ 0 ^ ++	TAZ H 336 * 025 C □ L C 9 ^ ++	H	33	25	0.9	10	100	120	8	10	10	0.150	0.41	0.37	0.16	0.37	0.33	0.15
CWR19K^336^@X+□	TAZ X 336 * 025 C □ # @ 0 ^ ++	TAZ X 336 * 025 C □ L C 9 ^ ++	X	33	25	0.9	10	100	120	8	10	10	0.200	0.47	0.42	0.19	0.42	0.38	0.17
CWR19M^334^@A+□	TAZ A 334 * 035 C □ # @ 0 ^ ++	TAZ A 334 * 035 C □ L C 9 ^ ++	A	0.33	35	22	1	10	12	6	8	8	0.050	0.05	0.04	0.02	1.05	0.94	0.42
CWR19M^685^@G+□	TAZ G 685 * 035 C □ # @ 0 ^ ++	TAZ G 685 * 035 C □ L C 9 ^ ++	G	6.8	35	1.5	3	30	36	6	8	8	0.125	0.29	0.26	0.12	0.43	0.39	0.17
CWR19M^106^@H+□	TAZ H 106 * 035 C □ # @ 0 ^ ++	TAZ H 106 * 035 C □ L C 9 ^ ++	H	10	35	0.9	4	40	48	8	10	10	0.150	0.41	0.37	0.16	0.37	0.33	0.15
CWR19M^156^@X+□	TAZ X 156 * 035 C □ # @ 0 ^ ++	TAZ X 156 * 035 C □ L C 9 ^ ++	X	15	35	0.9	6	60	72	6	8	8	0.200	0.47	0.42	0.19	0.42	0.38	0.17

All technical data relates to an ambient temperature of +25°C. Capacitance and DF are measured at 120Hz, 0.5V RMS with a maximum DC bias of 2.2 volts. DCL is measured at rated voltage after 5 minutes.

NOTE: KYOCERA AVX reserves the right to supply a higher voltage rating or tighter tolerance part in the same case size, to the same reliability standards.

TAZ SERIES



CWR29 - MIL-PRF-55365/11 Established Reliability, COTS-Plus & Space Level



A low ESR version of CWR09 and CWR19 that is fully qualified to MIL-PRF-55365/11, the CWR29 series represents the most flexible of surface mount form factors and the optimum power handling for all filtering applications. It is offered in nine case sizes (the original A through H of CWR09 and adding the new X case size).

The molded body / compliant termination construction ensures no TCE mismatch with any substrate. This construction is compatible with a wide range of SMT board assembly processes including convection reflow solder, conductive epoxy or compression bonding techniques. The parts also carry full polarity and capacitance / voltage marking.

The five smaller cases are characterized by their low profile construction, with the A case being the world's smallest molded military tantalum chip.

The series is qualified to MIL-PRF-55365 Weibull "B", "C", "D" and "T" levels, with all surge options ("A", "B" & "C") available.

For Space Level applications, SRC 9000 qualification is recommended (see ratings table for part number availability).

There are four termination finishes available: solder plated, fused solder plated, hot solder dipped and gold plated (these are "H", "K", "C" and "B" termination, respectively, per MIL-PRF-55365). In addition, the molding compound has been selected to meet the requirements of UL94V-0 (Flame Retardancy) and outgassing requirements of ASTM E-595.

For moisture sensitivity levels please refer to the High Reliability Tantalum MSL section located in the back of the High Reliability Tantalum Catalog.

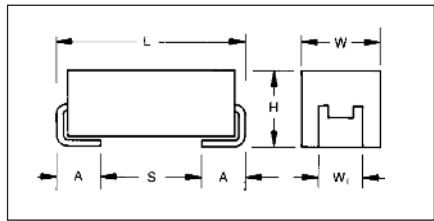

MARKING

(White marking on black body)



Polarity Stripe (+)

**Capacitance Code
Rated Voltage**

CASE DIMENSIONS:

millimeters (inches)

Case Code	Length (L) ±0.38 (0.015)	Width (W) ±0.38 (0.015)	Height (H) ±0.38 (0.015)	Term. Width (W ₁)	Term. Length (A) +0.25/-0.13 (+0.010/-0.005)	S min	Typical Weight (g)
A	2.54 (0.100)	1.27 (0.050)	1.27 (0.050)	1.27±0.13 (0.050±0.005)	0.76 (0.030)	0.38 (0.015)	0.016
B	3.81 (0.150)	1.27 (0.050)	1.27 (0.050)	1.27±0.13 (0.050±0.005)	0.76 (0.030)	1.65 (0.065)	0.025
C	5.08 (0.200)	1.27 (0.050)	1.27 (0.050)	1.27±0.13 (0.050±0.005)	0.76 (0.030)	2.92 (0.115)	0.035
D	3.81 (0.150)	2.54 (0.100)	1.27 (0.050)	2.41±0.13/-0.25 (0.095±0.005/-0.010)	0.76 (0.030)	1.65 (0.065)	0.045
E	5.08 (0.200)	2.54 (0.100)	1.27 (0.050)	2.41±0.13/-0.25 (0.095±0.005/-0.010)	0.76 (0.030)	2.92 (0.115)	0.065
F	5.59 (0.220)	3.43 (0.135)	1.78 (0.070)	3.30±0.13 (0.130±0.005)	0.76 (0.030)	3.43 (0.135)	0.125
G	6.73 (0.265)	2.79 (0.110)	2.79 (0.110)	2.67±0.13 (0.105±0.005)	1.27 (0.050)	3.56 (0.140)	0.205
H	7.24 (0.285)	3.81 (0.150)	2.79 (0.110)	3.68±0.13/-0.51 (0.145±0.005/-0.020)	1.27 (0.050)	4.06 (0.160)	0.335
X	6.93 (0.273)	5.41 (0.213)	2.74 (0.108)	3.05±0.13 (0.120±0.005)	1.19 (0.047)	3.67 (0.144)	0.420

CWR29-MIL-PRF 55365/11

CAPACITANCE AND RATED VOLTAGE, V_R (VOLTAGE CODE) RANGE (LETTER DENOTES CASE SIZE)

Capacitance		Rated Voltage DC (V _R) at 85°C							
µF	Code	4V (C)	6V (D)	10V (F)	15V (H)	20V (J)	25V (K)	35V (M)	50V (N)
0.10	104								A
0.15	154								A
0.22	224							A	B
0.33	334						A	A	B
0.47	474					A	A	B	C
0.68	684				A	A/B	B	C	D
1.0	105			A	A	A/B	B/C	D	E
1.5	155		A		A/B	B/C	D	E	F
2.2	225	A		A/B	A/C	B/D	D/E		F
3.3	335	A	A/B	A/C	B/D	D/E	E	F	G
4.7	475	A/B	A/C	B/C/D	B/C/D/E	E	F	G	H
6.8	685	A/C	B/D	B/C/D/E	D/E	E/F	F/G	G/H	
10	106	B/D	B/E	B/C/D/E	D/E/F	E/F	G	H	
15	156	B/E	B/D/E	D/E/F	E/F	F/G	G/H	X	
22	226	B/D	D/E/F	E	F/G	G/H	G/H		
33	336	D/E/F	E	F/G	F/G/H	H	H/X		
47	476	E	F/G	F/G/H	G/H	H/X			
68	686	E/G	F/G/H	G	G/H				
100	107	F/H	G	G/H	H				
150	157	G	G	H/X					
220	227	H	H	H					
330	337	H	H						



The Important Information/Disclaimer is incorporated in the catalog where these specifications came from or available online at www.kyocera-avx.com/disclaimer/ by reference and should be reviewed in full before placing any order.

HOW TO ORDER

COTS-PLUS & MIL QPL (CWR29):

TAZ	H	227	*	006	L	□	#	@	0	^	++
Type	Case Size	Capacitance Code pF code: 1st two digits represent significant figures 3rd digit represents multiplier (number of zeros to follow)	Capacitance Tolerance M = ±20% K = ±10% J = ±5%	Voltage Code 004 = 4Vdc 006 = 6Vdc 010 = 10Vdc 015 = 15Vdc 020 = 20Vdc 025 = 25Vdc 035 = 35Vdc 050 = 50Vdc	Standard or Low ESR Range L = Low ESR	Packaging B = Bulk R = 7" T&R S = 13" T&R W = Waffle See page 8 for additional packaging options.	Inspection Level S = Std. Conformance L = Group A M = MIL (JAN) CWR29	Reliability Grade Weibull: B = 0.1%/1000 hrs. 90% conf. C = 0.01%/1000 hrs. 90% conf. D = 0.001%/1000 hrs. 90% conf. Z = Non-ER	Qualification Level 0 = N/A T = T Level 9 = SRC9000	Termination Finish H = Solder Plated 0 = Fused Solder Plated 8 = Hot Solder Dipped 9 = Gold Plated 7 = Matte Sn (COTS-Plus only)	Surge Test Option 00 = None 23 = 10 Cycles, +25°C 24 = 10 Cycles, -55°C & +85°C 45 = 10 cycles, -55°C & +85°C before Weibull

For RoHS compliant products, please select correct termination style.

CWR29 P/N CROSS REFERENCE:

CWR29	D	^	227	*	C	H	+	□
Type	Voltage Code C = 4Vdc D = 6Vdc F = 10Vdc H = 15Vdc J = 20Vdc K = 25Vdc M = 35Vdc N = 50Vdc	Termination Finish H = Solder Plated K = Solder Fused C = Hot Solder Dipped B = Gold Plated <small>For RoHS compliant products, please select correct termination style.</small>	Capacitance Code pF code: 1st two digits represent significant figures 3rd digit represents multiplier (number of zeros to follow)	Capacitance Tolerance M = ±20% K = ±10% J = ±5%	Reliability Grade Weibull: B = 0.1%/1000 hrs. 90% conf. C = 0.01%/1000 hrs. 90% conf. D = 0.001%/1000 hrs. 90% conf. T = T Level A = Non-ER	Case Size	Surge Test Option A = 10 cycles, +25°C B = 10 cycles, -55°C & +85°C C = 10 cycles, -55°C & +85°C before Weibull Z = None required	Packaging Bulk = Standard TR = 7" T&R TR13 = 13" T&R W = Waffle See page 8 for additional packaging options.

SPACE LEVEL OPTIONS TO SRC9000*:

TAZ	H	227	*	006	C	□	L	C	9	^	++
Type	Case Size	Capacitance Code pF code: 1st two digits represent significant figures 3rd digit represents multiplier (number of zeros to follow)	Capacitance Tolerance M = ±20% K = ±10% J = ±5%	Voltage Code 004 = 4Vdc 006 = 6Vdc 010 = 10Vdc 015 = 15Vdc 020 = 20Vdc 025 = 25Vdc 035 = 35Vdc 050 = 50Vdc	Standard or Low ESR Range C = Std ESR L = Low ESR	Packaging B = Bulk R = 7" T&R S = 13" T&R W = Waffle See page 8 for additional packaging options.	Inspection Level L = Group A	Reliability Grade Weibull: C = 0.01%/1000 hrs. 90% conf.	Qualification Level 9 = SRC9000	Termination Finish H = Solder Plated 0 = Fused Solder Plated 8 = Hot Solder Dipped 9 = Gold Plated	Surge Test Option 45 = 10 cycles, -55°C & +85°C before Weibull GC = Group C Testing and Data OR = TOR compliant testing and data

For RoHS compliant products, please select correct termination style.

*Contact factory for SRC9000 Space Level SCD details.

TECHNICAL SPECIFICATIONS

Technical Data:	Unless otherwise specified, all technical data relate to an ambient temperature of 25°C									
Capacitance Range:	0.10 μF to 330 μF									
Capacitance Tolerance:	±5%; ±10%; ±20%									
Rated Voltage (V _R)	≤ 85°C:	4	6	10	15	20	25	35	50	
Category Voltage (V _C)	≤ 125°C:	2.7	4	6.7	10	13.3	16.7	23.3	33.3	
Surge Voltage (V _S)	≤ 85°C:	5.3	8	13.3	20	26.7	33.3	46.7	66.7	
Surge Voltage (V _S)	≤ 125°C:	3.5	5.3	8.7	13.3	17.8	22.2	31.1	44.5	
Temperature Range:	-55°C to +125°C									

TAZ SERIES

CWR29 - MIL-PRF-55365/11 Established Reliability,
COTS-Plus & Space Level



RATING & PART NUMBER REFERENCE				Parametric Specifications by Rating per MIL-PRF-55365/11								Typical RMS Ripple Data by Rating							
				Cap @ 120Hz µF @ 25°C	DC Rated Voltage V @ +85°C	ESR @ 100kHz Ohms @ +25°C	DCL max			DF Max			Power Dissipation W	25°C Ripple A (100kHz)	85°C Ripple A (100kHz)	125°C Ripple A (100kHz)	25°C Ripple V (100kHz)	85°C Ripple V (100kHz)	125°C Ripple V (100kHz)
							+25°C (µA)	+85°C (µA)	+125°C (µA)	+25°C (%)	+85/125°C (%)	-55°C (%)							
CWR29C*225*@A+□	TAZA225*004L□#@0^++	TAZA225*004L□LC9^++	A	2.2	4	4	1	10	12	6	8	8	0.050	0.11	0.10	0.04	0.45	0.40	0.18
CWR29C*335*@A+□	TAZA335*004L□#@0^++	TAZA335*004L□LC9^++	A	3.35	4	6	1	10	12	6	8	8	0.050	0.09	0.08	0.04	0.55	0.49	0.22
CWR29C*475*@A+□	TAZA475*004L□#@0^++	TAZA475*004L□LC9^++	A	4.7	4	6	1	10	12	6	8	8	0.050	0.09	0.08	0.04	0.55	0.49	0.22
CWR29C*475*@B+□	TAZB475*004L□#@0^++	TAZB475*004L□LC9^++	B	4.7	4	3.2	1	10	12	6	8	8	0.070	0.15	0.13	0.06	0.47	0.43	0.19
CWR29C*685*@A+□	TAZA685*004L□#@0^++	TAZA685*004L□LC9^++	A	6.8	4	6	1	10	12	6	8	8	0.050	0.09	0.08	0.04	0.55	0.49	0.22
CWR29C*685*@C+□	TAZC685*004L□#@0^++	TAZC685*004L□LC9^++	C	6.8	4	2.2	1	10	12	6	8	8	0.075	0.18	0.17	0.07	0.41	0.37	0.16
CWR29C*106*@B+□	TAZB106*004L□#@0^++	TAZB106*004L□LC9^++	B	10	4	3.2	1	10	12	8	10	10	0.070	0.15	0.13	0.06	0.47	0.43	0.19
CWR29C*106*@D+□	TAZD106*004L□#@0^++	TAZD106*004L□LC9^++	D	10	4	1.3	1	10	12	8	8	10	0.080	0.25	0.22	0.10	0.32	0.29	0.13
CWR29C*156*@B+□	TAZB156*004L□#@0^++	TAZB156*004L□LC9^++	B	15	4	3.2	1	10	12	8	10	10	0.070	0.15	0.13	0.06	0.47	0.43	0.19
CWR29C*156*@E+□	TAZE156*004L□#@0^++	TAZE156*004L□LC9^++	E	15	4	1	1	10	12	8	10	12	0.090	0.30	0.27	0.12	0.30	0.27	0.12
CWR29C*226*@B+□	TAZB226*004L□#@0^++	TAZB226*004L□LC9^++	B	22	4	3.2	1	10	12	8	10	10	0.070	0.15	0.13	0.06	0.47	0.43	0.19
CWR29C*226*@D+□	TAZD226*004L□#@0^++	TAZD226*004L□LC9^++	D	22	4	1.3	1	10	12	8	10	12	0.080	0.25	0.22	0.10	0.32	0.29	0.13
CWR29C*336*@D+□	TAZD336*004L□#@0^++	TAZD336*004L□LC9^++	D	33	4	1.3	2	20	24	8	10	12	0.080	0.25	0.22	0.10	0.32	0.29	0.13
CWR29C*336*@E+□	TAZE336*004L□#@0^++	TAZE336*004L□LC9^++	E	33	4	0.9	2	20	24	8	10	12	0.090	0.32	0.28	0.13	0.28	0.26	0.11
CWR29C*336*@F+□	TAZF336*004L□#@0^++	TAZF336*004L□LC9^++	F	33	4	0.6	2	20	24	8	10	12	0.100	0.41	0.37	0.16	0.24	0.22	0.10
CWR29C*476*@E+□	TAZE476*004L□#@0^++	TAZE476*004L□LC9^++	E	47	4	0.9	2	20	24	8	10	12	0.090	0.32	0.28	0.13	0.28	0.26	0.11
CWR29C*686*@E+□	TAZE686*004L□#@0^++	TAZE686*004L□LC9^++	E	68	4	0.9	3	30	36	8	10	12	0.090	0.32	0.28	0.13	0.28	0.26	0.11
CWR29C*686*@G+□	TAZG686*004L□#@0^++	TAZG686*004L□LC9^++	G	68	4	0.275	3	30	36	10	12	12	0.125	0.67	0.61	0.27	0.19	0.17	0.07
CWR29C*107*@F+□	TAZF107*004L□#@0^++	TAZF107*004L□LC9^++	F	100	4	0.55	4	40	48	10	12	12	0.100	0.43	0.38	0.17	0.23	0.21	0.09
CWR29C*107*@H+□	TAZH107*004L□#@0^++	TAZH107*004L□LC9^++	H	100	4	0.18	4	40	48	10	12	12	0.150	0.91	0.82	0.37	0.16	0.15	0.07
CWR29C*157*@G+□	TAZG157*004L□#@0^++	TAZG157*004L□LC9^++	G	150	4	0.25	6	60	72	10	12	12	0.125	0.71	0.64	0.28	0.18	0.16	0.07
CWR29C*227*@H+□	TAZH227*004L□#@0^++	TAZH227*004L□LC9^++	H	220	4	0.2	8	80	96	10	12	12	0.150	0.87	0.78	0.35	0.17	0.16	0.07
CWR29C*337*@H+□	TAZH337*004L□#@0^++	TAZH337*004L□LC9^++	H	330	4	0.18	10	100	120	10	12	12	0.150	0.91	0.82	0.37	0.16	0.15	0.07
CWR29D*155*@A+□	TAZA155*006L□#@0^++	TAZA155*006L□LC9^++	A	1.5	6	4	1	10	12	6	8	8	0.050	0.11	0.10	0.04	0.45	0.40	0.18
CWR29D*335*@A+□	TAZA335*006L□#@0^++	TAZA335*006L□LC9^++	A	3.3	6	6	1	10	12	6	8	8	0.050	0.09	0.08	0.04	0.55	0.49	0.22
CWR29D*335*@B+□	TAZB335*006L□#@0^++	TAZB335*006L□LC9^++	B	3.35	6	3.2	1	10	12	6	8	8	0.070	0.15	0.13	0.06	0.47	0.43	0.19
CWR29D*475*@A+□	TAZA475*006L□#@0^++	TAZA475*006L□LC9^++	A	4.7	6	6	1	10	12	6	8	8	0.050	0.09	0.08	0.04	0.55	0.49	0.22
CWR29D*475*@C+□	TAZC475*006L□#@0^++	TAZC475*006L□LC9^++	C	4.7	6	2.2	1	10	12	6	8	8	0.075	0.18	0.17	0.07	0.41	0.37	0.16
CWR29D*685*@B+□	TAZB685*006L□#@0^++	TAZB685*006L□LC9^++	B	6.8	6	3.2	1	10	12	6	8	8	0.070	0.15	0.13	0.06	0.47	0.43	0.19
CWR29D*685*@D+□	TAZD685*006L□#@0^++	TAZD685*006L□LC9^++	D	6.8	6	1.5	1	10	12	6	8	8	0.080	0.23	0.21	0.09	0.35	0.31	0.14
CWR29D*106*@B+□	TAZB106*006L□#@0^++	TAZB106*006L□LC9^++	B	10	6	3.2	1	10	12	6	8	8	0.070	0.15	0.13	0.06	0.47	0.43	0.19
CWR29D*106*@E+□	TAZE106*006L□#@0^++	TAZE106*006L□LC9^++	E	10	6	1	1	10	12	8	10	12	0.090	0.30	0.27	0.12	0.30	0.27	0.12
CWR29D*156*@B+□	TAZB156*006L□#@0^++	TAZB156*006L□LC9^++	B	15	6	3.2	1	10	12	8	10	10	0.070	0.15	0.13	0.06	0.47	0.43	0.19
CWR29D*156*@D+□	TAZD156*006L□#@0^++	TAZD156*006L□LC9^++	D	15	6	1.7	1	10	12	8	10	12	0.080	0.22	0.20	0.09	0.37	0.33	0.15
CWR29D*156*@E+□	TAZE156*006L□#@0^++	TAZE156*006L□LC9^++	E	15	6	0.9	1	10	12	8	10	12	0.090	0.32	0.28	0.13	0.28	0.26	0.11
CWR29D*226*@D+□	TAZD226*006L□#@0^++	TAZD226*006L□LC9^++	D	22	6	1.7	1	10	12	6	8	8	0.080	0.22	0.20	0.09	0.37	0.33	0.15
CWR29D*226*@E+□	TAZE226*006L□#@0^++	TAZE226*006L□LC9^++	E	22	6	1	2	20	24	8	10	12	0.090	0.30	0.27	0.12	0.30	0.27	0.12
CWR29D*226*@F+□	TAZF226*006L□#@0^++	TAZF226*006L□LC9^++	F	22	6	0.6	2	20	24	8	10	12	0.100	0.41	0.37	0.16	0.24	0.22	0.10
CWR29D*336*@E+□	TAZE336*006L□#@0^++	TAZE336*006L□LC9^++	E	33	6	1	2	20	24	6	8	8	0.090	0.30	0.27	0.12	0.30	0.27	0.12
CWR29D*476*@F+□	TAZF476*006L□#@0^++	TAZF476*006L□LC9^++	F	47	6	1	3	30	36	8	10	12	0.100	0.32	0.28	0.13	0.32	0.28	0.13
CWR29D*476*@G+□	TAZG476*006L□#@0^++	TAZG476*006L□LC9^++	G	47	6	0.275	3	30	36	10	12	12	0.125	0.67	0.61	0.27	0.19	0.17	0.07
CWR29D*686*@F+□	TAZF686*006L□#@0^++	TAZF686*006L□LC9^++	F	68	6	0.4	4	40	48	10	12	12	0.100	0.50	0.45	0.20	0.20	0.18	0.08
CWR29D*686*@G+□	TAZG686*006L□#@0^++	TAZG686*006L□LC9^++	G	68	6	0.25	4	40	48	10	12	12	0.125	0.71	0.64	0.28	0.18	0.16	0.07
CWR29D*686*@H+□	TAZH686*006L□#@0^++	TAZH686*006L□LC9^++	H	68	6	0.18	4	40	48	10	12	12	0.150	0.91	0.82	0.37	0.16	0.15	0.07
CWR29D*107*@G+□	TAZG107*006L□#@0^++	TAZG107*006L□LC9^++	G	100	6	0.275	6	60	72	10	12	12	0.125	0.67	0.61	0.27	0.19	0.17	0.07
CWR29D*157*@G+□	TAZG157*006L□#@0^++	TAZG157*006L□LC9^++	G	150	6	0.275	10	100	120	10	12	12	0.125	0.67	0.61	0.27	0.19	0.17	0.07
CWR29D*227*@H+□	TAZH227*006L□#@0^++	TAZH227*006L□LC9^++	H	220	6	0.18	10	100	120	10	12	12	0.150	0.91	0.82	0.37	0.16	0.15	0.07
CWR29D*337*@H+□	TAZH337*006L□#@0^++	TAZH337*006L□LC9^++	H	330	6	0.18	20	200	240	10	12	12	0.150	0.91	0.82	0.37	0.16	0.15	0.07
CWR29F*105*@A+□	TAZA105*010L□#@0^++	TAZA105*010L□LC9^++	A	1	10	5	1	10	12	6	8	8	0.050	0.10	0.09	0.04	0.50	0.45	0.20
CWR29F*225*@A+□	TAZA225*010L□#@0^++	TAZA225*010L□LC9^++	A	2.2	10	6	1	10	12	6	8	8	0.050	0.09	0.08	0.04	0.55	0.49	0.22
CWR29F*225*@B+□	TAZB225*010L□#@0^++	TAZB225*010L□LC9^++	B	2.2	10	3.2	1	10	12	6	8	8	0.070	0.15	0.13	0.06	0.47	0.43	0.19

All technical data relates to an ambient temperature of +25°C. Capacitance and DF are measured at 120Hz, 0.5V RMS with a maximum DC bias of 2.2 volts. DCL is measured at rated voltage after 5 minutes.

NOTE: KYOCERA AVX reserves the right to supply a higher voltage rating or tighter tolerance part in the same case size, to the same reliability standards.



The Important Information/Disclaimer is incorporated in the catalog where these specifications came from or available online at www.kyocera-avx.com/disclaimer/ by reference and should be reviewed in full before placing any order.

TDS-HIRELTANT-0016 | Rev 2

– HIGH RELIABILITY TANTALUM CAPACITORS –

TAZ SERIES

CWR29 - MIL-PRF-55365/11 Established Reliability, COTS-Plus & Space Level



RATING & PART NUMBER REFERENCE				Parametric Specifications by Rating per MIL-PRF-55365/11							Typical RMS Ripple Data by Rating								
				Cap @ 120Hz µF @ 25°C	DC Rated Voltage V @ +85°C	ESR @ 100kHz Ohms @ +25°C	DCL max			DF Max			Power Dissipation W	25°C Ripple A (100kHz)	85°C Ripple A (100kHz)	125°C Ripple A (100kHz)	25°C Ripple V (100kHz)	85°C Ripple V (100kHz)	125°C Ripple V (100kHz)
							+25°C (µA)	+85°C (µA)	+125°C (µA)	+25°C (%)	+(85/125)°C (%)	-55°C (%)							
CWR29 P/N	MIL & COTS-Plus P/N	SRC9000 P/N	Case	µF @ 25°C	V @ +85°C	Ohms @ +25°C	(µA)	(µA)	(µA)	(%)	(%)	(%)	W	A (100kHz)	A (100kHz)	A (100kHz)	V (100kHz)	V (100kHz)	V (100kHz)
CWR29F335* <u>A</u> +□	TAZA335*010L□#@0 ⁺ +	TAZA335*010L□LC9 ⁺ ++	A	3.3	10	6	1	10	12	6	8	8	0.050	0.09	0.08	0.04	0.55	0.49	0.22
CWR29F335* <u>C</u> +□	TAZC335*010L□#@0 ⁺ +	TAZC335*010L□LC9 ⁺ ++	C	3.3	10	2.2	1	10	12	6	8	8	0.075	0.18	0.17	0.07	0.41	0.37	0.16
CWR29F475* <u>B</u> +□	TAZB475*010L□#@0 ⁺ +	TAZB475*010L□LC9 ⁺ ++	B	4.7	10	3.2	1	10	12	6	8	8	0.070	0.15	0.13	0.06	0.47	0.43	0.19
CWR29F475* <u>C</u> +□	TAZC475*010L□#@0 ⁺ +	TAZC475*010L□LC9 ⁺ ++	C	4.7	10	2.2	1	10	12	6	8	8	0.075	0.18	0.17	0.07	0.41	0.37	0.16
CWR29F475* <u>D</u> +□	TAZD475*010L□#@0 ⁺ +	TAZD475*010L□LC9 ⁺ ++	D	4.7	10	1.5	1	10	12	6	8	8	0.080	0.23	0.21	0.09	0.35	0.31	0.14
CWR29F685* <u>B</u> +□	TAZB685*010L□#@0 ⁺ +	TAZB685*010L□LC9 ⁺ ++	B	6.8	10	3.2	1	10	12	6	8	8	0.070	0.15	0.13	0.06	0.47	0.43	0.19
CWR29F685* <u>C</u> +□	TAZC685*010L□#@0 ⁺ +	TAZC685*010L□LC9 ⁺ ++	C	6.8	10	2.2	1	10	12	6	8	8	0.075	0.18	0.17	0.07	0.41	0.37	0.16
CWR29F685* <u>D</u> +□	TAZD685*010L□#@0 ⁺ +	TAZD685*010L□LC9 ⁺ ++	D	6.8	10	1.7	1	10	12	6	8	8	0.080	0.22	0.20	0.09	0.37	0.33	0.15
CWR29F685* <u>E</u> +□	TAZE685*010L□#@0 ⁺ +	TAZE685*010L□LC9 ⁺ ++	E	6.8	10	1	1	10	12	6	8	8	0.090	0.30	0.27	0.12	0.30	0.27	0.12
CWR29F106* <u>B</u> +□	TAZB106*010L□#@0 ⁺ +	TAZB106*010L□LC9 ⁺ ++	B	10	10	3.2	1	10	12	6	10	10	0.070	0.15	0.13	0.06	0.47	0.43	0.19
CWR29F106* <u>C</u> +□	TAZC106*010L□#@0 ⁺ +	TAZC106*010L□LC9 ⁺ ++	C	10	10	2.2	1	10	12	6	8	8	0.075	0.18	0.17	0.07	0.41	0.37	0.16
CWR29F106* <u>D</u> +□	TAZD106*010L□#@0 ⁺ +	TAZD106*010L□LC9 ⁺ ++	D	10	10	1.3	1	10	12	6	8	8	0.080	0.25	0.22	0.10	0.32	0.29	0.13
CWR29F106* <u>E</u> +□	TAZE106*010L□#@0 ⁺ +	TAZE106*010L□LC9 ⁺ ++	E	10	10	1	1	10	12	6	8	8	0.090	0.30	0.27	0.12	0.30	0.27	0.12
CWR29F156* <u>D</u> +□	TAZD156*010L□#@0 ⁺ +	TAZD156*010L□LC9 ⁺ ++	D	15	10	1.7	2	20	24	6	8	8	0.080	0.22	0.20	0.09	0.37	0.33	0.15
CWR29F156* <u>E</u> +□	TAZE156*010L□#@0 ⁺ +	TAZE156*010L□LC9 ⁺ ++	E	15	10	0.9	2	20	24	8	10	10	0.090	0.32	0.28	0.13	0.28	0.26	0.11
CWR29F156* <u>F</u> +□	TAZF156*010L□#@0 ⁺ +	TAZF156*010L□LC9 ⁺ ++	F	15	10	0.7	2	20	24	8	10	10	0.100	0.38	0.34	0.15	0.26	0.24	0.11
CWR29F226* <u>E</u> +□	TAZE226*010L□#@0 ⁺ +	TAZE226*010L□LC9 ⁺ ++	E	22	10	0.6	3	30	36	8	10	10	0.090	0.39	0.35	0.15	0.23	0.21	0.09
CWR29F336* <u>F</u> +□	TAZF336*010L□#@0 ⁺ +	TAZF336*010L□LC9 ⁺ ++	F	33	10	0.4	3	30	36	8	10	10	0.100	0.50	0.45	0.20	0.20	0.18	0.08
CWR29F336* <u>G</u> +□	TAZG336*010L□#@0 ⁺ +	TAZG336*010L□LC9 ⁺ ++	G	33	10	0.275	3	30	36	10	12	12	0.125	0.67	0.61	0.27	0.19	0.17	0.07
CWR29F476* <u>F</u> +□	TAZF476*010L□#@0 ⁺ +	TAZF476*010L□LC9 ⁺ ++	F	47	10	0.4	4	40	48	10	12	12	0.100	0.50	0.45	0.20	0.20	0.18	0.08
CWR29F476* <u>G</u> +□	TAZG476*010L□#@0 ⁺ +	TAZG476*010L□LC9 ⁺ ++	G	47	10	0.25	4	40	48	10	12	12	0.125	0.71	0.64	0.28	0.18	0.16	0.07
CWR29F476* <u>H</u> +□	TAZH476*010L□#@0 ⁺ +	TAZH476*010L□LC9 ⁺ ++	H	47	10	0.18	5	50	60	10	12	12	0.150	0.91	0.82	0.37	0.16	0.15	0.07
CWR29F686* <u>G</u> +□	TAZG686*010L□#@0 ⁺ +	TAZG686*010L□LC9 ⁺ ++	G	68	10	0.275	6	60	72	10	12	12	0.125	0.67	0.61	0.27	0.19	0.17	0.07
CWR29F107* <u>G</u> +□	TAZG107*010L□#@0 ⁺ +	TAZG107*010L□LC9 ⁺ ++	G	100	10	0.275	10	100	120	10	12	12	0.125	0.67	0.61	0.27	0.19	0.17	0.07
CWR29F107* <u>H</u> +□	TAZH107*010L□#@0 ⁺ +	TAZH107*010L□LC9 ⁺ ++	H	100	10	0.18	10	100	120	10	12	12	0.150	0.91	0.82	0.37	0.16	0.15	0.07
CWR29F157* <u>H</u> +□	TAZH157*010L□#@0 ⁺ +	TAZH157*010L□LC9 ⁺ ++	H	150	10	0.18	15	150	180	10	12	12	0.150	0.91	0.82	0.37	0.16	0.15	0.07
CWR29F157* <u>X</u> +□	TAZX157*010L□#@0 ⁺ +	TAZX157*010L□LC9 ⁺ ++	X	150	10	0.065	15	150	180	10	12	12	0.200	1.75	1.58	0.70	0.11	0.10	0.05
CWR29F227* <u>H</u> +□	TAZH227*010L□#@0 ⁺ +	TAZH227*010L□LC9 ⁺ ++	H	220	10	0.18	20	200	240	10	12	12	0.150	0.91	0.82	0.37	0.16	0.15	0.07
CWR29H684* <u>A</u> +□	TAZA684*015L□#@0 ⁺ +	TAZA684*015L□LC9 ⁺ ++	A	6.84	15	6	1	10	12	6	8	8	0.050	0.09	0.08	0.04	0.55	0.49	0.22
CWR29H105* <u>A</u> +□	TAZA105*015L□#@0 ⁺ +	TAZA105*015L□LC9 ⁺ ++	A	1	15	7.5	1	10	12	6	8	8	0.050	0.08	0.07	0.03	0.61	0.55	0.24
CWR29H155* <u>A</u> +□	TAZA155*015L□#@0 ⁺ +	TAZA155*015L□LC9 ⁺ ++	A	1.5	15	7.5	1	10	12	6	8	8	0.050	0.08	0.07	0.03	0.61	0.55	0.24
CWR29H155* <u>B</u> +□	TAZB155*015L□#@0 ⁺ +	TAZB155*015L□LC9 ⁺ ++	B	1.5	15	3.2	1	10	12	6	8	8	0.070	0.15	0.13	0.06	0.47	0.43	0.19
CWR29H225* <u>A</u> +□	TAZA225*015L□#@0 ⁺ +	TAZA225*015L□LC9 ⁺ ++	A	2.2	15	7.5	1	10	12	6	8	8	0.050	0.08	0.07	0.03	0.61	0.55	0.24
CWR29H225* <u>C</u> +□	TAZC225*015L□#@0 ⁺ +	TAZC225*015L□LC9 ⁺ ++	C	2.2	15	2.2	1	10	12	6	8	8	0.075	0.18	0.17	0.07	0.41	0.37	0.16
CWR29H335* <u>B</u> +□	TAZB335*015L□#@0 ⁺ +	TAZB335*015L□LC9 ⁺ ++	B	3.3	15	3.6	1	10	12	6	8	8	0.070	0.14	0.13	0.06	0.50	0.45	0.20
CWR29H335* <u>D</u> +□	TAZD335*015L□#@0 ⁺ +	TAZD335*015L□LC9 ⁺ ++	D	3.3	15	1.7	1	10	12	6	8	8	0.080	0.22	0.20	0.09	0.37	0.33	0.15
CWR29H475* <u>B</u> +□	TAZB475*015L□#@0 ⁺ +	TAZB475*015L□LC9 ⁺ ++	B	4.7	15	2	1	10	12	6	8	8	0.070	0.19	0.17	0.07	0.37	0.34	0.15
CWR29H475* <u>C</u> +□	TAZC475*015L□#@0 ⁺ +	TAZC475*015L□LC9 ⁺ ++	C	4.7	15	2.2	1	10	12	6	8	8	0.075	0.18	0.17	0.07	0.41	0.37	0.16
CWR29H475* <u>D</u> +□	TAZD475*015L□#@0 ⁺ +	TAZD475*015L□LC9 ⁺ ++	D	4.7	15	2	1	10	12	6	8	8	0.080	0.20	0.18	0.08	0.40	0.36	0.16
CWR29H475* <u>E</u> +□	TAZE475*015L□#@0 ⁺ +	TAZE475*015L□LC9 ⁺ ++	E	4.7	15	1.2	1	10	12	6	8	8	0.090	0.27	0.25	0.11	0.33	0.30	0.13
CWR29H685* <u>D</u> +□	TAZD685*015L□#@0 ⁺ +	TAZD685*015L□LC9 ⁺ ++	D	6.8	15	2	1	10	12	6	8	8	0.080	0.20	0.18	0.08	0.40	0.36	0.16
CWR29H685* <u>E</u> +□	TAZE685*015L□#@0 ⁺ +	TAZE685*015L□LC9 ⁺ ++	E	6.8	15	0.9	1	10	12	8	10	12	0.090	0.32	0.28	0.13	0.28	0.26	0.11
CWR29H106* <u>D</u> +□	TAZD106*015L□#@0 ⁺ +	TAZD106*015L□LC9 ⁺ ++	D	10	15	2	2	20	24	6	8	8	0.080	0.20	0.18	0.08	0.40	0.36	0.16
CWR29H106* <u>E</u> +□	TAZE106*015L□#@0 ⁺ +	TAZE106*015L□LC9 ⁺ ++	E	10	15	1.2	2	20	24	6	8	8	0.090	0.27	0.25	0.11	0.33	0.30	0.13
CWR29H106* <u>F</u> +□	TAZF106*015L□#@0 ⁺ +	TAZF106*015L□LC9 ⁺ ++	F	10	15	0.667	2	20	24	6	8	8	0.100	0.39	0.35	0.15	0.26	0.23	0.10
CWR29H156* <u>E</u> +□	TAZE156*015L□#@0 ⁺ +	TAZE156*015L□LC9 ⁺ ++	E	15	15	1.2	2	20	24	6	8	8	0.090	0.27	0.25	0.11	0.33	0.30	0.13
CWR29H156* <u>F</u> +□	TAZF156*015L□#@0 ⁺ +	TAZF156*015L□LC9 ⁺ ++	F	15	15	0.8	2	20	24	8	10	10	0.100	0.35	0.32	0.14	0.28	0.25	0.11
CWR29H226* <u>F</u> +□	TAZF226*015L□#@0 ⁺ +	TAZF226*015L□LC9 ⁺ ++	F	22	15	0.8	3	30	36	8	10	10	0.100	0.35	0.32	0.14	0.28	0.25	0.11
CWR29H226* <u>G</u> +□	TAZG226*015L□#@0 ⁺ +	TAZG226*015L□LC9 ⁺ ++	G	22	15	0.275	4	40	48	6	8	8	0.125	0.67	0.61	0.27	0.19	0.17	0.07
CWR29H336* <u>F</u> +□	TAZF336*015L□#@0 ⁺ +	TAZF336*015L□LC9 ⁺ ++	F	33	15	0.8	5	50	60	6	8	8	0.100	0.35	0.32	0.14	0.28	0.25	0.11
CWR29H336* <u>G</u> +□	TAZG336*015L□#@0 ⁺ +	TAZG336*015L□LC9 ⁺ ++	G	33	15	0.275	6	60	72	8	10	10	0.125	0.67	0.61	0.27	0.19	0.17	0.07

All technical data relates to an ambient temperature of +25°C. Capacitance and DF are measured at 120Hz, 0.5V RMS with a maximum DC bias of 2.2 volts. DCL is measured at rated voltage after 5 minutes.

NOTE: KYOCERA AVX reserves the right to supply a higher voltage rating or tighter tolerance part in the same case size, to the same reliability standards.

TAZ SERIES

CWR29 - MIL-PRF-55365/11 Established Reliability, COTS-Plus & Space Level



RATING & PART NUMBER REFERENCE				Parametric Specifications by Rating per MIL-PRF-55365/11								Typical RMS Ripple Data by Rating							
				Cap @ 120Hz µF @ 25°C	DC Rated Voltage V @ +85°C	ESR @ 100kHz Ohms @ +25°C	DCL max			DF Max		Power Dissipation W	25°C Ripple A (100kHz)	85°C Ripple A (100kHz)	125°C Ripple A (100kHz)	25°C Ripple V (100kHz)	85°C Ripple V (100kHz)	125°C Ripple V (100kHz)	
							+25°C (µA)	+85°C (µA)	+125°C (µA)	+25°C (%)	(85/125)°C (%)								-55°C (%)
CWR29H*336*G+	TAZ H 336 * 015 L □ # @ 0 + + +	TAZ H 336 * 015 L □ L C 9 + + +	H	33	15	0.18	5	50	60	8	8	10	0.150	0.91	0.82	0.37	0.16	0.15	0.07
CWR29H*476*G+	TAZ G 476 * 015 L □ # @ 0 + + +	TAZ G 476 * 015 L □ L C 9 + + +	G	47	15	0.275	10	100	120	8	10	10	0.125	0.67	0.61	0.27	0.19	0.17	0.07
CWR29H*476*H+	TAZ H 476 * 015 L □ # @ 0 + + +	TAZ H 476 * 015 L □ L C 9 + + +	H	47	15	0.18	10	100	120	8	10	10	0.150	0.91	0.82	0.37	0.16	0.15	0.07
CWR29H*686*G+	TAZ G 686 * 015 L □ # @ 0 + + +	TAZ G 686 * 015 L □ L C 9 + + +	G	68	15	0.275	10	100	120	8	10	10	0.125	0.67	0.61	0.27	0.19	0.17	0.07
CWR29H*686*H+	TAZ H 686 * 015 L □ # @ 0 + + +	TAZ H 686 * 015 L □ L C 9 + + +	H	68	15	0.18	10	100	120	8	10	10	0.150	0.91	0.82	0.37	0.16	0.15	0.07
CWR29H*107*H+	TAZ H 107 * 015 L □ # @ 0 + + +	TAZ H 107 * 015 L □ L C 9 + + +	H	100	15	0.18	15	150	180	10	12	12	0.150	0.91	0.82	0.37	0.16	0.15	0.07
CWR29J*474*A+	TAZ A 474 * 020 L □ # @ 0 + + +	TAZ A 474 * 020 L □ L C 9 + + +	A	0.47	20	7.5	1	10	12	8	8	10	0.050	0.08	0.07	0.03	0.61	0.55	0.24
CWR29J*684*A+	TAZ A 684 * 020 L □ # @ 0 + + +	TAZ A 684 * 020 L □ L C 9 + + +	A	0.68	20	7.5	1	10	12	6	8	8	0.050	0.08	0.07	0.03	0.61	0.55	0.24
CWR29J*684*B+	TAZ B 684 * 020 L □ # @ 0 + + +	TAZ B 684 * 020 L □ L C 9 + + +	B	0.68	20	5.6	1	10	12	6	8	8	0.070	0.11	0.10	0.04	0.63	0.56	0.25
CWR29J*105*A+	TAZ A 105 * 020 L □ # @ 0 + + +	TAZ A 105 * 020 L □ L C 9 + + +	A	1	20	7.5	1	10	12	6	8	8	0.050	0.08	0.07	0.03	0.61	0.55	0.24
CWR29J*105*B+	TAZ B 105 * 020 L □ # @ 0 + + +	TAZ B 105 * 020 L □ L C 9 + + +	B	1	20	4.8	1	10	12	6	8	8	0.070	0.12	0.11	0.05	0.58	0.52	0.23
CWR29J*155*B+	TAZ B 155 * 020 L □ # @ 0 + + +	TAZ B 155 * 020 L □ L C 9 + + +	B	1.5	20	3.6	1	10	12	6	8	8	0.070	0.14	0.13	0.06	0.50	0.45	0.20
CWR29J*155*C+	TAZ C 155 * 020 L □ # @ 0 + + +	TAZ C 155 * 020 L □ L C 9 + + +	C	1.5	20	2.4	1	10	12	6	8	8	0.075	0.18	0.16	0.07	0.42	0.38	0.17
CWR29J*225*B+	TAZ B 225 * 020 L □ # @ 0 + + +	TAZ B 225 * 020 L □ L C 9 + + +	B	2.2	20	3.6	1	10	12	6	8	8	0.070	0.14	0.13	0.06	0.50	0.45	0.20
CWR29J*225*D+	TAZ D 225 * 020 L □ # @ 0 + + +	TAZ D 225 * 020 L □ L C 9 + + +	D	2.2	20	1.7	1	10	12	6	8	8	0.080	0.22	0.20	0.09	0.37	0.33	0.15
CWR29J*335*D+	TAZ D 335 * 020 L □ # @ 0 + + +	TAZ D 335 * 020 L □ L C 9 + + +	D	3.3	20	2	1	10	12	6	8	8	0.080	0.20	0.18	0.08	0.40	0.36	0.16
CWR29J*335*E+	TAZ E 335 * 020 L □ # @ 0 + + +	TAZ E 335 * 020 L □ L C 9 + + +	E	3.3	20	1.2	1	10	12	6	8	8	0.090	0.27	0.25	0.11	0.33	0.30	0.13
CWR29J*475*E+	TAZ E 475 * 020 L □ # @ 0 + + +	TAZ E 475 * 020 L □ L C 9 + + +	E	4.7	20	1.7	1	10	12	6	8	8	0.090	0.23	0.21	0.09	0.39	0.35	0.16
CWR29J*685*E+	TAZ E 685 * 020 L □ # @ 0 + + +	TAZ E 685 * 020 L □ L C 9 + + +	E	6.8	20	1.5	2	20	24	6	8	8	0.090	0.24	0.22	0.10	0.37	0.33	0.15
CWR29J*685*F+	TAZ F 685 * 020 L □ # @ 0 + + +	TAZ F 685 * 020 L □ L C 9 + + +	F	6.8	20	0.7	2	20	24	6	8	8	0.100	0.38	0.34	0.15	0.26	0.24	0.11
CWR29J*106*E+	TAZ E 106 * 020 L □ # @ 0 + + +	TAZ E 106 * 020 L □ L C 9 + + +	E	10	20	1.5	2	20	24	6	8	8	0.090	0.24	0.22	0.10	0.37	0.33	0.15
CWR29J*106*F+	TAZ F 106 * 020 L □ # @ 0 + + +	TAZ F 106 * 020 L □ L C 9 + + +	F	10	20	0.8	2	20	24	6	8	8	0.100	0.35	0.32	0.14	0.28	0.25	0.11
CWR29J*156*F+	TAZ F 156 * 020 L □ # @ 0 + + +	TAZ F 156 * 020 L □ L C 9 + + +	F	15	20	0.8	3	30	36	6	8	8	0.100	0.35	0.32	0.14	0.28	0.25	0.11
CWR29J*156*G+	TAZ G 156 * 020 L □ # @ 0 + + +	TAZ G 156 * 020 L □ L C 9 + + +	G	15	20	0.275	3	30	36	6	8	8	0.125	0.67	0.61	0.27	0.19	0.17	0.07
CWR29J*226*G+	TAZ G 226 * 020 L □ # @ 0 + + +	TAZ G 226 * 020 L □ L C 9 + + +	G	22	20	0.625	4	40	48	6	8	8	0.125	0.45	0.40	0.18	0.28	0.25	0.11
CWR29J*226*H+	TAZ H 226 * 020 L □ # @ 0 + + +	TAZ H 226 * 020 L □ L C 9 + + +	H	22	20	0.18	4	40	48	6	8	8	0.150	0.91	0.82	0.37	0.16	0.15	0.07
CWR29J*336*H+	TAZ H 336 * 020 L □ # @ 0 + + +	TAZ H 336 * 020 L □ L C 9 + + +	H	33	20	0.18	6	60	72	8	10	10	0.150	0.91	0.82	0.37	0.16	0.15	0.07
CWR29J*476*H+	TAZ H 476 * 020 L □ # @ 0 + + +	TAZ H 476 * 020 L □ L C 9 + + +	H	47	20	0.18	10	100	120	8	10	10	0.150	0.91	0.82	0.37	0.16	0.15	0.07
CWR29J*476*X+	TAZ X 476 * 020 L □ # @ 0 + + +	TAZ X 476 * 020 L □ L C 9 + + +	X	47	20	0.11	10	100	120	8	10	10	0.200	1.35	1.21	0.54	0.15	0.13	0.06
CWR29K*334*A+	TAZ A 334 * 025 L □ # @ 0 + + +	TAZ A 334 * 025 L □ L C 9 + + +	A	0.33	25	7.5	1	10	12	6	8	8	0.050	0.08	0.07	0.03	0.61	0.55	0.24
CWR29K*474*A+	TAZ A 474 * 025 L □ # @ 0 + + +	TAZ A 474 * 025 L □ L C 9 + + +	A	0.47	25	7.5	1	10	12	6	8	8	0.050	0.08	0.07	0.03	0.61	0.55	0.24
CWR29K*684*B+	TAZ B 684 * 025 L □ # @ 0 + + +	TAZ B 684 * 025 L □ L C 9 + + +	B	0.68	25	4	1	10	12	6	8	8	0.070	0.13	0.12	0.05	0.53	0.48	0.21
CWR29K*105*B+	TAZ B 105 * 025 L □ # @ 0 + + +	TAZ B 105 * 025 L □ L C 9 + + +	B	1	25	4	1	10	12	6	8	8	0.070	0.13	0.12	0.05	0.53	0.48	0.21
CWR29K*105*C+	TAZ C 105 * 025 L □ # @ 0 + + +	TAZ C 105 * 025 L □ L C 9 + + +	C	1	25	2.6	1	10	12	6	8	8	0.075	0.17	0.15	0.07	0.44	0.40	0.18
CWR29K*155*D+	TAZ D 155 * 025 L □ # @ 0 + + +	TAZ D 155 * 025 L □ L C 9 + + +	D	1.5	25	1.7	1	10	12	6	8	8	0.080	0.22	0.20	0.09	0.37	0.33	0.15
CWR29K*225*D+	TAZ D 225 * 025 L □ # @ 0 + + +	TAZ D 225 * 025 L □ L C 9 + + +	D	2.2	25	2	1	10	12	6	8	8	0.080	0.20	0.18	0.08	0.40	0.36	0.16
CWR29K*225*E+	TAZ E 225 * 025 L □ # @ 0 + + +	TAZ E 225 * 025 L □ L C 9 + + +	E	2.2	25	1	1	10	12	6	8	8	0.090	0.30	0.27	0.12	0.30	0.27	0.12
CWR29K*335*E+	TAZ E 335 * 025 L □ # @ 0 + + +	TAZ E 335 * 025 L □ L C 9 + + +	E	3.3	25	1.2	1	10	12	6	8	8	0.090	0.27	0.25	0.11	0.33	0.30	0.13
CWR29K*475*F+	TAZ F 475 * 025 L □ # @ 0 + + +	TAZ F 475 * 025 L □ L C 9 + + +	F	4.7	25	0.7	2	20	24	6	8	8	0.100	0.38	0.34	0.15	0.26	0.24	0.11
CWR29K*685*F+	TAZ F 685 * 025 L □ # @ 0 + + +	TAZ F 685 * 025 L □ L C 9 + + +	F	6.8	25	0.8	2	20	24	6	8	8	0.100	0.35	0.32	0.14	0.28	0.25	0.11
CWR29K*685*G+	TAZ G 685 * 025 L □ # @ 0 + + +	TAZ G 685 * 025 L □ L C 9 + + +	G	6.8	25	0.3	2	20	24	6	8	8	0.125	0.65	0.58	0.26	0.19	0.17	0.08
CWR29K*106*G+	TAZ G 106 * 025 L □ # @ 0 + + +	TAZ G 106 * 025 L □ L C 9 + + +	G	10	25	0.35	3	30	36	6	8	8	0.125	0.60	0.54	0.24	0.21	0.19	0.08
CWR29K*156*G+	TAZ G 156 * 025 L □ # @ 0 + + +	TAZ G 156 * 025 L □ L C 9 + + +	G	15	25	0.35	4	40	48	6	8	8	0.125	0.60	0.54	0.24	0.21	0.19	0.08
CWR29K*156*H+	TAZ H 156 * 025 L □ # @ 0 + + +	TAZ H 156 * 025 L □ L C 9 + + +	H	15	25	0.2	4	40	48	6	8	8	0.150	0.87	0.78	0.35	0.17	0.16	0.07
CWR29K*226*G+	TAZ G 226 * 025 L □ # @ 0 + + +	TAZ G 226 * 025 L □ L C 9 + + +	G	22	25	0.35	6	60	72	6	8	8	0.125	0.60	0.54	0.24	0.21	0.19	0.08
CWR29K*226*H+	TAZ H 226 * 025 L □ # @ 0 + + +	TAZ H 226 * 025 L □ L C 9 + + +	H	22	25	0.18	6	60	72	6	8	8	0.150	0.91	0.82	0.37	0.16	0.15	0.07
CWR29K*336*H+	TAZ H 336 * 025 L □ # @ 0 + + +	TAZ H 336 * 025 L □ L C 9 + + +	H	33	25	0.18	10	100	120	8	10	10	0.150	0.91	0.82	0.37	0.16	0.15	0.07
CWR29K*336*X+	TAZ X 336 * 025 L □ # @ 0 + + +	TAZ X 336 * 025 L □ L C 9 + + +	X	33	25	0.13	10	100	120	8	10	10	0.200	1.24	1.12	0.50	0.16	0.15	0.06
CWR29M*224*A+	TAZ A 224 * 035 L □ # @ 0 + + +	TAZ A 224 * 035 L □ L C 9 + + +	A	0.22	35	12	1	10	12	6	8	8	0.050	0.06	0.06	0.03	0.77	0.70	0.31
CWR29M*334*A+	TAZ A 334 * 035 L □ # @ 0 + + +	TAZ A 334 * 035 L □ L C 9 + + +	A	0.33	35	12	1	10	12	6	8	8	0.050	0.06	0.06	0.03	0.77	0.70	0.31
CWR29M*474*B+	TAZ B 474 * 035 L □ # @ 0 + + +	TAZ B 474 * 035 L □ L C 9 + + +	B	0.47	35	6.8	1	10	12	6	8	8	0.070	0.10	0.09	0.04	0.69	0.62	0.28
CWR29M*684*C+	TAZ C 684 * 035 L □ # @ 0 + + +	TAZ C 684 * 035 L □ L C 9 + + +	C	0.68	35	4	1	10	12	6	8	8	0.075	0.14	0.12	0.05	0.55	0.49	0.22

All technical data relates to an ambient temperature of +25°C. Capacitance and DF are measured at 120Hz, 0.5V RMS

TAZ SERIES

CWR29 - MIL-PRF-55365/11 Established Reliability, COTS-Plus & Space Level



RATING & PART NUMBER REFERENCE				Parametric Specifications by Rating per MIL-PRF-55365/11									Typical RMS Ripple Data by Rating						
				Cap @ 120Hz	DC Rated Voltage	ESR @ 100kHz	DCL max			DF Max			Power Dissipation	25°C Ripple	85°C Ripple	125°C Ripple	25°C Ripple	85°C Ripple	125°C Ripple
							+25°C	+85°C	+125°C	+25°C	+(85/125)°C	-55°C							
CWR29 P/N	MIL & COTS-Plus P/N	SRC9000 P/N	Case	µF @ 25°C	V @ +85°C	Ohms @ +25°C	(µA)	(µA)	(µA)	(%)	(%)	(%)	W	A (100kHz)	A (100kHz)	A (100kHz)	V (100kHz)	V (100kHz)	V (100kHz)
CWR29M*105*@D+	TAZ D 105*035L□#@0^++	TAZ D 105*035L□LC9^++	D	1	35	2.2	1	10	12	6	8	8	0.080	0.19	0.17	0.08	0.42	0.38	0.17
CWR29M*155*@E+	TAZE 155*035L□#@0^++	TAZE 155*035L□LC9^++	E	1.5	35	1.3	1	10	12	6	8	8	0.090	0.26	0.24	0.11	0.34	0.31	0.14
CWR29M*335*@F+	TAZF 335*035L□#@0^++	TAZF 335*035L□LC9^++	F	3.3	35	0.7	1	10	12	6	8	8	0.100	0.38	0.34	0.15	0.26	0.24	0.11
CWR29M*475*@G+	TAZ G 475*035L□#@0^++	TAZ G 475*035L□LC9^++	G	4.7	35	0.375	2	20	24	6	8	8	0.125	0.58	0.52	0.23	0.22	0.19	0.09
CWR29M*685*@G+	TAZ G 685*035L□#@0^++	TAZ G 685*035L□LC9^++	G	6.8	35	0.375	3	30	36	6	8	8	0.125	0.58	0.52	0.23	0.22	0.19	0.09
CWR29M*685*@H+	TAZ H 685*035L□#@0^++	TAZ H 685*035L□LC9^++	H	6.8	35	0.5	3	30	36	6	8	8	0.150	0.55	0.49	0.22	0.27	0.25	0.11
CWR29M*106*@H+	TAZ H 106*035L□#@0^++	TAZ H 106*035L□LC9^++	H	10	35	0.5	4	40	48	8	10	10	0.150	0.55	0.49	0.22	0.27	0.25	0.11
CWR29M*156*@X+	TAZ X 156*035L□#@0^++	TAZ X 156*035L□LC9^++	X	15	35	0.19	6	60	72	6	8	8	0.200	1.03	0.92	0.41	0.19	0.18	0.08
CWR29N*104*@A+	TAZ A 104*050L□#@0^++	TAZ A 104*050L□LC9^++	A	0.1	50	12	1	10	12	6	8	8	0.050	0.06	0.06	0.03	0.77	0.70	0.31
CWR29N*154*@A+	TAZ A 154*050L□#@0^++	TAZ A 154*050L□LC9^++	A	0.15	50	12	1	10	12	6	8	8	0.050	0.06	0.06	0.03	0.77	0.70	0.31
CWR29N*224*@B+	TAZ B 224*050L□#@0^++	TAZ B 224*050L□LC9^++	B	0.22	50	6.8	1	10	12	6	8	8	0.070	0.10	0.09	0.04	0.69	0.62	0.28
CWR29N*334*@B+	TAZ B 334*050L□#@0^++	TAZ B 334*050L□LC9^++	B	0.33	50	4.8	1	10	12	6	8	8	0.070	0.12	0.11	0.05	0.58	0.52	0.23
CWR29N*474*@C+	TAZ C 474*050L□#@0^++	TAZ C 474*050L□LC9^++	C	0.47	50	3.2	1	10	12	6	8	8	0.075	0.15	0.14	0.06	0.49	0.44	0.20
CWR29N*684*@D+	TAZ D 684*050L□#@0^++	TAZ D 684*050L□LC9^++	D	0.68	50	2.3	1	10	12	6	8	8	0.080	0.19	0.17	0.07	0.43	0.39	0.17
CWR29N*105*@E+	TAZE 105*050L□#@0^++	TAZE 105*050L□LC9^++	E	1	50	1.7	1	10	12	6	8	8	0.090	0.23	0.21	0.09	0.39	0.35	0.16
CWR29N*155*@F+	TAZF 155*050L□#@0^++	TAZF 155*050L□LC9^++	F	1.5	50	1.1	1	10	12	6	8	8	0.100	0.30	0.27	0.12	0.33	0.30	0.13
CWR29N*225*@F+	TAZF 225*050L□#@0^++	TAZF 225*050L□LC9^++	F	2.2	50	0.7	2	20	24	6	8	8	0.100	0.38	0.34	0.15	0.26	0.24	0.11
CWR29N*335*@G+	TAZ G 335*050L□#@0^++	TAZ G 335*050L□LC9^++	G	3.3	50	0.5	2	20	24	6	8	8	0.125	0.50	0.45	0.20	0.25	0.23	0.10
CWR29N*475*@H+	TAZ H 475*050L□#@0^++	TAZ H 475*050L□LC9^++	H	4.7	50	0.5	3	30	36	6	8	8	0.150	0.55	0.49	0.22	0.27	0.25	0.11

All technical data relates to an ambient temperature of +25°C. Capacitance and DF are measured at 120Hz, 0.5V RMS with a maximum DC bias of 2.2 volts. DCL is measured at rated voltage after 5 minutes.

NOTE: KYOCERA AVX reserves the right to supply a higher voltage rating or tighter tolerance part in the same case size, to the same reliability standards.

TAZ SERIES

HRC5000 Medical Implantable Grade



GENERAL DESCRIPTION

The TAZ HRC5000 Medical Grade series is designed for use in medical implantable applications. These are based off of the MIL-PRF-55365 case sizes and feature extremely low DC leakage levels well below typical values. These components are manufactured and tested in the KYOCERA AVX Biddeford Maine factory which is ISO 13485 certified. Weibull grading and surge current testing options per MIL-PRF-55365 are available along with several plating options including tin/lead solder, 100% tin, or gold terminations. To request an additional rating not listed here, or for more information on HRC5000 testing details, please contact the factory. For moisture sensitivity levels please refer to the High Reliability Tantalum MSL section located in the back of the High Reliability Tantalum Catalog.

MARKING

(White marking on black body)

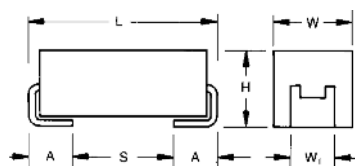

Polarity Stripe (+)

Capacitance Code
Rated Voltage

CASE DIMENSIONS:

millimeters (inches)

Case Code	Length (L) ±0.38 (0.015)	Width (W) ±0.38 (0.015)	Height (H) ±0.38 (0.015)	Term. Width (W _t)	Term. Length (A) +0.25/-0.13 (+0.010/-0.005)	S min	Typical Weight (g)
A	2.54 (0.100)	1.27 (0.050)	1.27 (0.050)	1.27±0.13 (0.050±0.005)	0.76 (0.030)	0.38 (0.015)	0.016
B	3.81 (0.150)	1.27 (0.050)	1.27 (0.050)	1.27±0.13 (0.050±0.005)	0.76 (0.030)	1.65 (0.065)	0.025
C	5.08 (0.200)	1.27 (0.050)	1.27 (0.050)	1.27±0.13 (0.050±0.005)	0.76 (0.030)	2.92 (0.115)	0.035
D	3.81 (0.150)	2.54 (0.100)	1.27 (0.050)	2.41+0.13/-0.25 (0.095+0.005/-0.010)	0.76 (0.030)	1.65 (0.065)	0.045
E	5.08 (0.200)	2.54 (0.100)	1.27 (0.050)	2.41+0.13/-0.25 (0.095+0.005/-0.010)	0.76 (0.030)	2.92 (0.115)	0.065
F	5.59 (0.220)	3.43 (0.135)	1.78 (0.070)	3.30±0.13 (0.130±0.005)	0.76 (0.030)	3.43 (0.135)	0.125
G	6.73 (0.265)	2.79 (0.110)	2.79 (0.110)	2.67±0.13 (0.105±0.005)	1.27 (0.050)	3.56 (0.140)	0.205
H	7.24 (0.285)	3.81 (0.150)	2.79 (0.110)	3.68+0.13/-0.51 (0.145+0.005/-0.020)	1.27 (0.050)	4.06 (0.160)	0.335
R	2.05 (0.081) ±0.20 (0.008)	1.30 (0.051) +0.20 (0.008) -0.10 (0.004)	1.20 (0.047) max	1.0±0.10 (0.039±0.004)	0.50 (0.20) +0.30 (0.012) -0.20 (0.008)	0.71 (0.028)	0.010

TAZ SERIES

HRC5000 Medical Implantable Grade

CAPACITANCE AND RATED VOLTAGE, V_R (VOLTAGE CODE) RANGE (LETTER DENOTES CASE SIZE)

Capacitance		Rated Voltage								
μF	Code	4V	6V	10V	12V	15V	20V	25V	35V	50V
0.10	104									A
0.15	154									A
0.22	224								A	
0.33	334			R				A		
0.47	474						A		B	
0.68	684					A				
1	105			A		A	A/B	B	D	E
1.5	155		A	A			B	D		
2.2	225	A	A	A/B		A/B	B/D	D/E		F
3.3	335		A/B	A/B		B/D	E	E	F	G
4.7	475	A/B	A	B/D		B/D/E	D/E	F		
6	605									
6.8	685	A	D	B/D/E			D/E	F		
10	106	D	B/D/E	B/D/E		D/E/F	E	G	H	
14	146			E						
15	156		B/D/F	D/E/F		E	F/G			
22	226		F	D/E/F	E	F/G	G/H	H		
33	336	E/F	E	F/G		F/H				
47	476	E	E/F/G	F/G/H		G	H			
68	686	E/G	E/F/G/H	G						
100	107	F	G	H		H				
150	157		G	H						
220	227			H						
300	307		H							
330	337		H							

HOW TO ORDER

TAZ	E	106	*	010	C		L	@	5	^	++
Type	Case Size	Capacitance Code	Capacitance Tolerance	Voltage Code	ESR	Packaging	Inspection Level	Reliability Grade	Qualification Level	Termination Finish	Surge Test Option
		pF code: 1st two digits represent significant figures 3rd digit represents multiplier (number of zeros to follow)	J = $\pm 5\%$ K = $\pm 10\%$ M = $\pm 20\%$	004 = 4Vdc 006 = 6Vdc 010 = 10Vdc 015 = 15Vdc 020 = 20Vdc 025 = 25Vdc 035 = 35Vdc 050 = 50Vdc	C = Std ESR L = Low ESR	B = Bulk R = 7" T&R W = Waffle	L = Group A	Weibull: B = 0.1%/1000 hrs. 90% conf. C = 0.01%/1000 hrs. 90% conf.	5 = HRC5000	H = Solder Plated 0 = Solder Fused 9 = Gold Plated 7 = 100% Tin	00 = None 23 = 10 Cycles, +25°C 24 = 10 Cycles, -55°C & +85°C 45 = 10 cycles, -55°C & +85°C before Weibull

For RoHS compliant products, please select correct termination style.

*Contact factory for KYOCERA AVX HRC5000 Medical Grade SCD details.

TECHNICAL SPECIFICATIONS

Technical Data:	Unless otherwise specified, all technical data relate to an ambient temperature of 25°C									
Capacitance Range:	0.10 μF to 330 μF									
Capacitance Tolerance:	$\pm 5\%$; $\pm 10\%$; $\pm 20\%$									
Rated Voltage (V_R)	$\leq 85^\circ\text{C}$:	4	6	10	15	20	25	35	50	
Category Voltage (V_C)	$\leq 125^\circ\text{C}$:	2.7	4	6.7	10	13.3	16.7	23.3	33.3	
Surge Voltage (V_S)	$\leq 85^\circ\text{C}$:	5.3	8	13.3	20	26.7	33.3	46.7	66.7	
Surge Voltage (V_S)	$\leq 125^\circ\text{C}$:	3.5	5.3	8.7	13.3	17.8	22.2	31.1	44.5	
Temperature Range:	-55°C to +125°C									

TAZ SERIES

HRC5000 Medical Implantable Grade



RATING & PART NUMBER REFERENCE		Parametric Specifications by Rating									Typical RMS Ripple Data by Rating						
		Cap @ 120Hz	DC Rated Voltage	ESR @ 100kHz	DCL max			DF Max			Power Dissipation	25°C Ripple Current	85°C Ripple Current	125°C Ripple Current	25°C Ripple Voltage	85°C Ripple Voltage	125°C Ripple Voltage
					+25°C	+85°C	+125°C	+25°C	+(85/125)°C	-55°C							
P/N	Case	µF @ 25°C	V @ +85°C	Ohms @ +25°C	(µA)	(µA)	(µA)	(%)	(%)	(%)	W	A (100kHz)	A (100kHz)	A (100kHz)	V (100kHz)	V (100kHz)	V (100kHz)
TAZA225*004L□L@5 ⁺ ++	A	2.2	4	4	0.100	1.000	1.200	6	8	8	0.050	0.112	0.101	0.045	0.447	0.402	0.179
TAZA225*004C□L@5 ⁺ ++	A	2.2	4	8	0.100	1.000	1.200	6	8	8	0.050	0.079	0.071	0.032	0.632	0.569	0.253
TAZA475*004L□L@5 ⁺ ++	A	4.7	4	6	0.100	1.000	1.200	6	8	8	0.050	0.091	0.082	0.037	0.548	0.493	0.219
TAZA475*004C□L@5 ⁺ ++	A	4.7	4	12	0.100	1.000	1.200	6	8	8	0.050	0.065	0.058	0.026	0.775	0.697	0.310
TAZB475*004L□L@5 ⁺ ++	B	4.7	4	3.2	0.100	1.000	1.200	6	8	8	0.070	0.148	0.133	0.059	0.473	0.426	0.189
TAZB475*004C□L@5 ⁺ ++	B	4.7	4	8	0.100	1.000	1.200	6	8	8	0.070	0.094	0.084	0.037	0.748	0.673	0.299
TAZA685*004L□L@5 ⁺ ++	A	6.8	4	6	0.100	1.000	1.200	6	8	8	0.050	0.091	0.082	0.037	0.548	0.493	0.219
TAZA685*004C□L@5 ⁺ ++	A	6.8	4	12	0.100	1.000	1.200	6	8	8	0.050	0.065	0.058	0.026	0.775	0.697	0.310
TAZD106*004L□L@5 ⁺ ++	D	10	4	1.3	0.100	1.000	1.200	8	8	10	0.080	0.248	0.223	0.099	0.322	0.290	0.129
TAZD106*004C□L@5 ⁺ ++	D	10	4	4	0.100	1.000	1.200	8	8	10	0.080	0.141	0.127	0.057	0.566	0.509	0.226
TAZE336*004L□L@5 ⁺ ++	E	33	4	0.9	0.330	3.300	3.960	8	10	12	0.090	0.316	0.285	0.126	0.285	0.256	0.114
TAZE336*004C□L@5 ⁺ ++	E	33	4	3	0.330	3.300	3.960	8	10	12	0.090	0.173	0.156	0.069	0.520	0.468	0.208
TAZF336*004L□L@5 ⁺ ++	F	33	4	0.6	0.330	3.300	3.960	8	10	12	0.100	0.408	0.367	0.163	0.245	0.220	0.098
TAZF336*004C□L@5 ⁺ ++	F	33	4	2.2	0.330	3.300	3.960	8	10	12	0.100	0.213	0.192	0.085	0.469	0.422	0.188
TAZE476*004L□L@5 ⁺ ++	E	47	4	0.9	0.470	4.700	5.640	8	10	12	0.090	0.316	0.285	0.126	0.285	0.256	0.114
TAZE476*004C□L@5 ⁺ ++	E	47	4	3	0.470	4.700	5.640	8	10	12	0.090	0.173	0.156	0.069	0.520	0.468	0.208
TAZE686*004L□L@5 ⁺ ++	E	68	4	0.9	0.680	6.800	8.160	8	10	12	0.090	0.316	0.285	0.126	0.285	0.256	0.114
TAZE686*004C□L@5 ⁺ ++	E	68	4	3	0.680	6.800	8.160	8	10	12	0.090	0.173	0.156	0.069	0.520	0.468	0.208
TAZG686*004L□L@5 ⁺ ++	G	68	4	0.275	0.680	6.800	8.160	10	12	12	0.125	0.674	0.607	0.270	0.185	0.167	0.074
TAZG686*004C□L@5 ⁺ ++	G	68	4	1.1	0.680	6.800	8.160	10	12	12	0.125	0.337	0.303	0.135	0.371	0.334	0.148
TAZF107*004L□L@5 ⁺ ++	F	100	4	0.55	1.000	10.000	12.000	10	12	12	0.100	0.426	0.384	0.171	0.235	0.211	0.094
TAZF107*004C□L@5 ⁺ ++	F	100	4	2	1.000	10.000	12.000	10	12	12	0.100	0.224	0.201	0.089	0.447	0.402	0.179
TAZA155*006L□L@5 ⁺ ++	A	1.5	6	4	0.100	1.000	1.200	6	8	8	0.050	0.112	0.101	0.045	0.447	0.402	0.179
TAZA155*006C□L@5 ⁺ ++	A	1.5	6	8	0.100	1.000	1.200	6	8	8	0.050	0.079	0.071	0.032	0.632	0.569	0.253
TAZA225*006L□L@5 ⁺ ++	A	2.2	6	6	0.100	1.000	1.200	6	8	8	0.050	0.091	0.082	0.037	0.548	0.493	0.219
TAZA225*006C□L@5 ⁺ ++	A	2.2	6	12	0.100	1.000	1.200	6	8	8	0.050	0.065	0.058	0.026	0.775	0.697	0.310
TAZA335*006L□L@5 ⁺ ++	A	3.3	6	6	0.100	1.000	1.200	6	8	8	0.050	0.091	0.082	0.037	0.548	0.493	0.219
TAZA335*006C□L@5 ⁺ ++	A	3.3	6	12	0.100	1.000	1.200	6	8	8	0.050	0.065	0.058	0.026	0.775	0.697	0.310
TAZB335*006L□L@5 ⁺ ++	B	3.3	6	3.2	0.100	1.000	1.200	6	8	8	0.070	0.148	0.133	0.059	0.473	0.426	0.189
TAZB335*006C□L@5 ⁺ ++	B	3.3	6	8	0.100	1.000	1.200	6	8	8	0.070	0.094	0.084	0.037	0.748	0.673	0.299
TAZA475*006L□L@5 ⁺ ++	A	4.7	6	6	0.100	1.000	1.200	6	8	8	0.050	0.091	0.082	0.037	0.548	0.493	0.219
TAZA475*006C□L@5 ⁺ ++	A	4.7	6	12	0.100	1.000	1.200	6	8	8	0.050	0.065	0.058	0.026	0.775	0.697	0.310
TAZD685*006L□L@5 ⁺ ++	D	6.8	6	1.5	0.102	1.020	1.224	6	8	8	0.080	0.231	0.208	0.092	0.346	0.312	0.139
TAZD685*006C□L@5 ⁺ ++	D	6.8	6	4.5	0.102	1.020	1.224	6	8	8	0.080	0.133	0.120	0.053	0.600	0.540	0.240
TAZB106*006L□L@5 ⁺ ++	B	10	6	3.2	0.150	1.500	1.800	6	8	8	0.070	0.148	0.133	0.059	0.473	0.426	0.189
TAZB106*006C□L@5 ⁺ ++	B	10	6	8	0.150	1.500	1.800	6	8	8	0.070	0.094	0.084	0.037	0.748	0.673	0.299
TAZD106*006L□L@5 ⁺ ++	D	10	6	3	0.150	1.500	1.800	6	8	8	0.080	0.163	0.147	0.065	0.490	0.441	0.196
TAZD106*006C□L@5 ⁺ ++	D	10	6	6	0.150	1.500	1.800	6	8	8	0.080	0.115	0.104	0.046	0.693	0.624	0.277

All technical data relates to an ambient temperature of +25°C. Capacitance and DF are measured at 120Hz, 0.5V RMS with a maximum DC bias of 2.2 volts. DCL is measured at rated voltage after 5 minutes.

NOTE: KYOCERA AVX reserves the right to supply a higher voltage rating or tighter tolerance part in the same case size, to the same reliability standards.

TAZ SERIES

HRC5000 Medical Implantable Grade



RATING & PART NUMBER REFERENCE		Parametric Specifications by Rating									Typical RMS Ripple Data by Rating						
		Cap @ 120Hz	DC Rated Voltage	ESR @ 100kHz	DCL max			DF Max			Power Dissipation	25°C Ripple Current	85°C Ripple Current	125°C Ripple Current	25°C Ripple Voltage	85°C Ripple Voltage	125°C Ripple Voltage
					+25°C	+85°C	+125°C	+25°C	+(85/125)°C	-55°C							
P/N	Case	µF @ 25°C	V @ +85°C	Ohms @ +25°C	(µA)	(µA)	(µA)	(%)	(%)	(%)	W	A (100kHz)	A (100kHz)	A (100kHz)	V (100kHz)	V (100kHz)	V (100kHz)
TAZE106*006L□L@5+++	E	10	6	1	0.150	1.500	1.800	8	10	12	0.090	0.300	0.270	0.120	0.300	0.270	0.120
TAZE106*006C□L@5+++	E	10	6	3.5	0.150	1.500	1.800	8	10	12	0.090	0.160	0.144	0.064	0.561	0.505	0.224
TAZB156*006L□L@5+++	B	15	6	3.2	0.225	2.250	2.700	8	10	10	0.070	0.148	0.133	0.059	0.473	0.426	0.189
TAZB156*006C□L@5+++	B	15	6	8	0.225	2.250	2.700	8	10	10	0.070	0.094	0.084	0.037	0.748	0.673	0.299
TAZD156*006L□L@5+++	D	15	6	1.7	0.225	2.250	2.700	8	10	12	0.080	0.217	0.195	0.087	0.369	0.332	0.148
TAZD156*006C□L@5+++	D	15	6	5	0.225	2.250	2.700	8	10	12	0.080	0.126	0.114	0.051	0.632	0.569	0.253
TAZF156*006L□L@5+++	F	15	6	0.15	0.225	2.250	2.700	6	8	8	0.100	0.816	0.735	0.327	0.122	0.110	0.049
TAZF156*006C□L@5+++	F	15	6	0.3	0.225	2.250	2.700	6	8	8	0.100	0.577	0.520	0.231	0.173	0.156	0.069
TAZF226*006L□L@5+++	F	22	6	0.6	0.330	3.300	3.960	8	10	12	0.100	0.408	0.367	0.163	0.245	0.220	0.098
TAZF226*006C□L@5+++	F	22	6	2.2	0.330	3.300	3.960	8	10	12	0.100	0.213	0.192	0.085	0.469	0.422	0.188
TAZE336*006L□L@5+++	E	33	6	1	0.495	4.950	5.940	6	8	8	0.090	0.300	0.270	0.120	0.300	0.270	0.120
TAZE336*006C□L@5+++	E	33	6	3.5	0.495	4.950	5.940	6	8	8	0.090	0.160	0.144	0.064	0.561	0.505	0.224
TAZE476*006L□L@5+++	E	47	6	2.5	0.705	7.050	8.460	6	8	8	0.090	0.190	0.171	0.076	0.474	0.427	0.190
TAZE476*006C□L@5+++	E	47	6	5	0.705	7.050	8.460	6	8	8	0.090	0.134	0.121	0.054	0.671	0.604	0.268
TAZF476*006L□L@5+++	F	47	6	1	0.705	7.050	8.460	8	10	12	0.100	0.316	0.285	0.126	0.316	0.285	0.126
TAZF476*006C□L@5+++	F	47	6	3.5	0.705	7.050	8.460	8	10	12	0.100	0.169	0.152	0.068	0.592	0.532	0.237
TAZG476*006L□L@5+++	G	47	6	0.275	0.705	7.050	8.460	10	12	12	0.125	0.674	0.607	0.270	0.185	0.167	0.074
TAZG476*006C□L@5+++	G	47	6	1.1	0.705	7.050	8.460	10	12	12	0.125	0.337	0.303	0.135	0.371	0.334	0.148
TAZE686*006L□C@5+++	E	68	6	1	1.020	10.200	12.240	10	12	12	0.090	0.300	0.270	0.120	0.300	0.270	0.120
TAZE686*006C□L@5+++	E	68	6	2	1.020	10.200	12.240	10	12	12	0.090	0.212	0.191	0.085	0.424	0.382	0.170
TAZF686*006L□L@5+++	F	68	6	0.4	1.020	10.200	12.240	10	12	12	0.100	0.500	0.450	0.200	0.200	0.180	0.080
TAZF686*006C□L@5+++	F	68	6	1.5	1.020	10.200	12.240	10	12	12	0.100	0.258	0.232	0.103	0.387	0.349	0.155
TAZG686*006L□L@5+++	G	68	6	0.25	1.020	10.200	12.240	10	12	12	0.125	0.707	0.636	0.283	0.177	0.159	0.071
TAZG686*006C□L@5+++	G	68	6	1	1.020	10.200	12.240	10	12	12	0.125	0.354	0.318	0.141	0.354	0.318	0.141
TAZH686*006L□L@5+++	H	68	6	0.18	1.020	10.200	12.240	10	12	12	0.150	0.913	0.822	0.365	0.164	0.148	0.066
TAZH686*006C□L@5+++	H	68	6	0.9	1.020	10.200	12.240	10	12	12	0.150	0.408	0.367	0.163	0.367	0.331	0.147
TAZG107*006L□L@5+++	G	100	6	0.275	1.500	15.000	18.000	10	12	12	0.125	0.674	0.607	0.270	0.185	0.167	0.074
TAZG107*006C□L@5+++	G	100	6	1.1	1.500	15.000	18.000	10	12	12	0.125	0.337	0.303	0.135	0.371	0.334	0.148
TAZG157*006L□L@5+++	G	150	6	0.275	2.250	22.500	27.000	10	12	12	0.125	0.674	0.607	0.270	0.185	0.167	0.074
TAZG157*006C□L@5+++	G	150	6	1.1	2.250	22.500	27.000	10	12	12	0.125	0.337	0.303	0.135	0.371	0.334	0.148
TAZH307*006L□L@5+++	H	300	6	0.18	4.500	45.000	54.000	15	18	18	0.150	0.913	0.822	0.365	0.164	0.148	0.066
TAZH307*006C□L@5+++	H	300	6	0.9	4.500	45.000	54.000	15	18	18	0.150	0.408	0.367	0.163	0.367	0.331	0.147
TAZH337*006L□L@5+++	H	330	6	0.18	4.950	49.500	59.400	10	12	12	0.150	0.913	0.822	0.365	0.164	0.148	0.066
TAZH337*006C□L@5+++	H	330	6	0.9	4.950	49.500	59.400	10	12	12	0.150	0.408	0.367	0.163	0.367	0.331	0.147
TAZR334*010C□L@5+++	R	0.33	10	50	0.100	1.000	1.200	6	8	8	0.030	0.024	0.022	0.010	1.225	1.102	0.490
TAZA105*010L□L@5+++	A	1	10	5	0.100	1.000	1.200	6	8	8	0.050	0.100	0.090	0.040	0.500	0.450	0.200
TAZA105*010C□L@5+++	A	1	10	10	0.100	1.000	1.200	6	8	8	0.050	0.071	0.064	0.028	0.707	0.636	0.283
TAZA155*010C□L@5+++	A	1.5	10	12	0.100	1.000	1.200	6	8	8	0.050	0.065	0.058	0.026	0.775	0.697	0.310

All technical data relates to an ambient temperature of +25°C. Capacitance and DF are measured at 120Hz, 0.5V RMS with a maximum DC bias of 2.2 volts. DCL is measured at rated voltage after 5 minutes.

NOTE: KYOCERA AVX reserves the right to supply a higher voltage rating or tighter tolerance part in the same case size, to the same reliability standards.

TAZ SERIES

HRC5000 Medical Implantable Grade



RATING & PART NUMBER REFERENCE		Parametric Specifications by Rating									Typical RMS Ripple Data by Rating						
		Cap @ 120Hz	DC Rated Voltage	ESR @ 100kHz	DCL max			DF Max			Power Dissipation	25°C Ripple Current	85°C Ripple Current	125°C Ripple Current	25°C Ripple Voltage	85°C Ripple Voltage	125°C Ripple Voltage
					+25°C	+85°C	+125°C	+25°C	+(85/125)°C	-55°C							
P/N	Case	µF @ 25°C	V @ +85°C	Ohms @ +25°C	(µA)	(µA)	(µA)	(%)	(%)	(%)	W	A (100kHz)	A (100kHz)	A (100kHz)	V (100kHz)	V (100kHz)	V (100kHz)
TAZA225*010L□L@5 ⁺ ++	A	2.2	10	6	0.100	1.000	1.200	6	8	8	0.050	0.091	0.082	0.037	0.548	0.493	0.219
TAZA225*010C□L@5 ⁺ ++	A	2.2	10	12	0.100	1.000	1.200	6	8	8	0.050	0.065	0.058	0.026	0.775	0.697	0.310
TAZB225*010L□L@5 ⁺ ++	B	2.2	10	3.2	0.100	1.000	1.200	6	8	8	0.070	0.148	0.133	0.059	0.473	0.426	0.189
TAZB225*010C□L@5 ⁺ ++	B	2.2	10	8	0.100	1.000	1.200	6	8	8	0.070	0.094	0.084	0.037	0.748	0.673	0.299
TAZA335*010L□L@5 ⁺ ++	A	3.3	10	6	0.100	1.000	1.200	6	8	8	0.050	0.091	0.082	0.037	0.548	0.493	0.219
TAZA335*010C□L@5 ⁺ ++	A	3.3	10	12	0.100	1.000	1.200	6	8	8	0.050	0.065	0.058	0.026	0.775	0.697	0.310
TAZB335*010L□L@5 ⁺ ++	B	3.3	10	9	0.100	1.000	1.200	6	8	8	0.070	0.088	0.079	0.035	0.794	0.714	0.317
TAZB335*010C□L@5 ⁺ ++	B	3.3	10	18	0.100	1.000	1.200	6	8	8	0.070	0.062	0.056	0.025	1.122	1.010	0.449
TAZB475*010L□L@5 ⁺ ++	B	4.7	10	3.2	0.200	2.000	2.400	6	8	8	0.070	0.148	0.133	0.059	0.473	0.426	0.189
TAZB475*010C□L@5 ⁺ ++	B	4.7	10	8	0.200	2.000	2.400	6	8	8	0.070	0.094	0.084	0.037	0.748	0.673	0.299
TAZD475*010L□L@5 ⁺ ++	D	4.7	10	1.5	0.200	2.000	2.400	6	8	8	0.080	0.231	0.208	0.092	0.346	0.312	0.139
TAZD475*010C□L@5 ⁺ ++	D	4.7	10	4.5	0.200	2.000	2.400	6	8	8	0.080	0.133	0.120	0.053	0.600	0.540	0.240
TAZB685*010L□L@5 ⁺ ++	B	6.8	10	3.2	0.170	1.700	2.040	6	8	8	0.070	0.148	0.133	0.059	0.473	0.426	0.189
TAZB685*010C□L@5 ⁺ ++	B	6.8	10	8	0.170	1.700	2.040	6	8	8	0.070	0.094	0.084	0.037	0.748	0.673	0.299
TAZD685*010L□L@5 ⁺ ++	D	6.8	10	1.7	0.170	1.700	2.040	6	8	8	0.080	0.217	0.195	0.087	0.369	0.332	0.148
TAZD685*010C□L@5 ⁺ ++	D	6.8	10	5	0.170	1.700	2.040	6	8	8	0.080	0.126	0.114	0.051	0.632	0.569	0.253
TAZE685*010L□L@5 ⁺ ++	E	6.8	10	1	0.170	1.700	2.040	6	8	8	0.090	0.300	0.270	0.120	0.300	0.270	0.120
TAZE685*010C□L@5 ⁺ ++	E	6.8	10	3.5	0.170	1.700	2.040	6	8	8	0.090	0.160	0.144	0.064	0.561	0.505	0.224
TAZB106*010L□L@5 ⁺ ++	B	10	10	3.2	0.250	2.500	3.000	8	10	10	0.070	0.148	0.133	0.059	0.473	0.426	0.189
TAZB106*010C□L@5 ⁺ ++	B	10	10	8	0.250	2.500	3.000	8	10	10	0.070	0.094	0.084	0.037	0.748	0.673	0.299
TAZD106*010L□L@5 ⁺ ++	D	10	10	1.3	0.250	2.500	3.000	6	8	8	0.080	0.248	0.223	0.099	0.322	0.290	0.129
TAZD106*010C□L@5 ⁺ ++	D	10	10	4	0.250	2.500	3.000	6	8	8	0.080	0.141	0.127	0.057	0.566	0.509	0.226
TAZE106*010L□L@5 ⁺ ++	E	10	10	1	0.250	2.500	3.000	6	8	8	0.090	0.300	0.270	0.120	0.300	0.270	0.120
TAZE106*010C□L@5 ⁺ ++	E	10	10	3.5	0.250	2.500	3.000	6	8	8	0.090	0.160	0.144	0.064	0.561	0.505	0.224
TAZE146*010L□L@5 ⁺ ++	E	14	10	1.5	0.350	3.500	4.200	6	8	8	0.090	0.245	0.220	0.098	0.367	0.331	0.147
TAZE146*010C□L@5 ⁺ ++	E	14	10	3	0.350	3.500	4.200	6	8	8	0.090	0.173	0.156	0.069	0.520	0.468	0.208
TAZD156*010L□L@5 ⁺ ++	D	15	10	1.7	0.375	3.750	4.500	6	8	8	0.080	0.217	0.195	0.087	0.369	0.332	0.148
TAZD156*010C□L@5 ⁺ ++	D	15	10	5	0.375	3.750	4.500	6	8	8	0.080	0.126	0.114	0.051	0.632	0.569	0.253
TAZE156*010L□L@5 ⁺ ++	E	15	10	0.9	0.375	3.750	4.500	8	10	10	0.090	0.316	0.285	0.126	0.285	0.256	0.114
TAZE156*010C□L@5 ⁺ ++	E	15	10	3	0.375	3.750	4.500	8	10	10	0.090	0.173	0.156	0.069	0.520	0.468	0.208
TAZF156*010L□L@5 ⁺ ++	F	15	10	0.7	0.375	3.750	4.500	8	8	10	0.100	0.378	0.340	0.151	0.265	0.238	0.106
TAZF156*010C□L@5 ⁺ ++	F	15	10	2.5	0.375	3.750	4.500	8	8	10	0.100	0.200	0.180	0.080	0.500	0.450	0.200
TAZD226*010L□L@5 ⁺ ++	D	22	10	4	0.550	5.500	6.600	6	8	8	0.080	0.141	0.127	0.057	0.566	0.509	0.226
TAZD226*010C□L@5 ⁺ ++	D	22	10	8	0.550	5.500	6.600	6	8	8	0.080	0.100	0.090	0.040	0.800	0.720	0.320
TAZE226*010L□L@5 ⁺ ++	E	22	10	0.6	0.550	5.500	6.600	8	10	10	0.090	0.387	0.349	0.155	0.232	0.209	0.093
TAZE226*010C□L@5 ⁺ ++	E	22	10	2	0.550	5.500	6.600	8	10	10	0.090	0.212	0.191	0.085	0.424	0.382	0.170
TAZF226*010L□L@5 ⁺ ++	F	22	10	1.5	0.550	5.500	6.600	8	10	10	0.100	0.258	0.232	0.103	0.387	0.349	0.155
TAZF226*010C□L@5 ⁺ ++	F	22	10	3	0.550	5.500	6.600	8	10	10	0.100	0.183	0.164	0.073	0.548	0.493	0.219

All technical data relates to an ambient temperature of +25°C. Capacitance and DF are measured at 120Hz, 0.5V RMS with a maximum DC bias of 2.2 volts. DCL is measured at rated voltage after 5 minutes.

NOTE: KYOCERA AVX reserves the right to supply a higher voltage rating or tighter tolerance part in the same case size, to the same reliability standards.

TAZ SERIES

HRC5000 Medical Implantable Grade



RATING & PART NUMBER REFERENCE		Parametric Specifications by Rating									Typical RMS Ripple Data by Rating						
		Cap @ 120Hz	DC Rated Voltage	ESR @ 100kHz	DCL max			DF Max			Power Dissipation	25°C Ripple Current	85°C Ripple Current	125°C Ripple Current	25°C Ripple Voltage	85°C Ripple Voltage	125°C Ripple Voltage
					+25°C	+85°C	+125°C	+25°C	+(85/125)°C	-55°C							
P/N	Case	µF @ 25°C	V @ +85°C	Ohms @ +25°C	(µA)	(µA)	(µA)	(%)	(%)	(%)	W	A (100kHz)	A (100kHz)	A (100kHz)	V (100kHz)	V (100kHz)	V (100kHz)
TAZF336*010L@5+++	F	33	10	0.4	0.825	8.250	9.900	8	10	10	0.100	0.500	0.450	0.200	0.200	0.180	0.080
TAZF336*010C@5+++	F	33	10	1.5	0.825	8.250	9.900	8	10	10	0.100	0.258	0.232	0.103	0.387	0.349	0.155
TAZG336*010L@5+++	G	33	10	0.275	0.825	8.250	9.900	10	12	12	0.125	0.674	0.607	0.270	0.185	0.167	0.074
TAZG336*010C@5+++	G	33	10	1.1	0.825	8.250	9.900	10	12	12	0.125	0.337	0.303	0.135	0.371	0.334	0.148
TAZF476*010L@5+++	F	47	10	0.4	1.175	11.750	14.100	10	12	12	0.100	0.500	0.450	0.200	0.200	0.180	0.080
TAZF476*010C@5+++	F	47	10	1.5	1.175	11.750	14.100	10	12	12	0.100	0.258	0.232	0.103	0.387	0.349	0.155
TAZG476*010L@5+++	G	47	10	0.25	1.175	11.750	14.100	10	12	12	0.125	0.707	0.636	0.283	0.177	0.159	0.071
TAZG476*010C@5+++	G	47	10	1	1.175	11.750	14.100	10	12	12	0.125	0.354	0.318	0.141	0.354	0.318	0.141
TAZH476*010L@5+++	H	47	10	0.18	1.175	11.750	14.100	10	12	12	0.150	0.913	0.822	0.365	0.164	0.148	0.066
TAZH476*010C@5+++	H	47	10	0.9	1.175	11.750	14.100	10	12	12	0.150	0.408	0.367	0.163	0.367	0.331	0.147
TAZG686*010L@5+++	G	68	10	0.275	1.700	17.000	20.400	10	12	12	0.125	0.674	0.607	0.270	0.185	0.167	0.074
TAZG686*010C@5+++	G	68	10	1.1	1.700	17.000	20.400	10	12	12	0.125	0.337	0.303	0.135	0.371	0.334	0.148
TAZH107*010L@5+++	H	100	10	0.18	2.500	25.000	30.000	10	12	12	0.150	0.913	0.822	0.365	0.164	0.148	0.066
TAZH107*010C@5+++	H	100	10	0.9	2.500	25.000	30.000	10	12	12	0.150	0.408	0.367	0.163	0.367	0.331	0.147
TAZH157*010L@5+++	H	150	10	0.18	3.750	37.500	45.000	10	12	12	0.150	0.913	0.822	0.365	0.164	0.148	0.066
TAZH157*010C@5+++	H	150	10	0.9	3.750	37.500	45.000	10	12	12	0.150	0.408	0.367	0.163	0.367	0.331	0.147
TAZH227*010L@5+++	H	220	10	0.18	5.500	55.000	66.000	10	12	12	0.150	0.913	0.822	0.365	0.164	0.148	0.066
TAZH227*010C@5+++	H	220	10	0.9	5.500	55.000	66.000	10	12	12	0.150	0.408	0.367	0.163	0.367	0.331	0.147
TAZE226*012L@5+++	E	22	12	0.25	0.660	6.600	7.920	6	8	8	0.090	0.600	0.540	0.240	0.150	0.135	0.060
TAZE226*012C@5+++	E	22	12	0.5	0.660	6.600	7.920	6	8	8	0.090	0.424	0.382	0.170	0.212	0.191	0.085
TAZA684*015L@5+++	A	0.68	15	6	0.100	1.000	1.200	6	8	8	0.050	0.091	0.082	0.037	0.548	0.493	0.219
TAZA684*015C@5+++	A	0.68	15	12	0.100	1.000	1.200	6	8	8	0.050	0.065	0.058	0.026	0.775	0.697	0.310
TAZA105*015L@5+++	A	1	15	7.5	0.100	1.000	1.200	6	8	8	0.050	0.082	0.073	0.033	0.612	0.551	0.245
TAZA105*015C@5+++	A	1	15	15	0.100	1.000	1.200	6	8	8	0.050	0.058	0.052	0.023	0.866	0.779	0.346
TAZA225*015L@5+++	A	2.2	15	7.5	0.200	2.000	2.400	6	8	8	0.050	0.082	0.073	0.033	0.612	0.551	0.245
TAZA225*015C@5+++	A	2.2	15	15	0.200	2.000	2.400	6	8	8	0.050	0.058	0.052	0.023	0.866	0.779	0.346
TAZB225*015L@5+++	B	2.2	15	2.75	0.100	1.000	1.200	6	8	8	0.070	0.160	0.144	0.064	0.439	0.395	0.175
TAZB225*015C@5+++	B	2.2	15	5.5	0.100	1.000	1.200	6	8	8	0.070	0.113	0.102	0.045	0.620	0.558	0.248
TAZB335*015L@5+++	B	3.3	15	3.6	0.290	2.900	3.480	6	8	8	0.070	0.139	0.125	0.056	0.502	0.452	0.201
TAZB335*015C@5+++	B	3.3	15	9	0.290	2.900	3.480	6	8	8	0.070	0.088	0.079	0.035	0.794	0.714	0.317
TAZD335*015L@5+++	D	3.3	15	1.7	0.124	1.240	1.488	6	8	8	0.080	0.217	0.195	0.087	0.369	0.332	0.148
TAZD335*015C@5+++	D	3.3	15	5	0.124	1.240	1.488	6	8	8	0.080	0.126	0.114	0.051	0.632	0.569	0.253
TAZB475*015L@5+++	B	4.7	15	2	0.250	2.500	3.000	6	8	8	0.070	0.187	0.168	0.075	0.374	0.337	0.150
TAZB475*015C@5+++	B	4.7	15	5	0.250	2.500	3.000	6	8	8	0.070	0.118	0.106	0.047	0.592	0.532	0.237
TAZD475*015L@5+++	D	4.7	15	2	0.250	2.500	3.000	6	8	8	0.080	0.200	0.180	0.080	0.400	0.360	0.160
TAZD475*015C@5+++	D	4.7	15	6	0.250	2.500	3.000	6	8	8	0.080	0.115	0.104	0.046	0.693	0.624	0.277
TAZE475*015L@5+++	E	4.7	15	1.2	0.245	2.450	2.940	6	8	8	0.090	0.274	0.246	0.110	0.329	0.296	0.131
TAZE475*015C@5+++	E	4.7	15	4	0.245	2.450	2.940	6	8	8	0.090	0.150	0.135	0.060	0.600	0.540	0.240

All technical data relates to an ambient temperature of +25°C. Capacitance and DF are measured at 120Hz, 0.5V RMS with a maximum DC bias of 2.2 volts. DCL is measured at rated voltage after 5 minutes.

NOTE: KYOCERA AVX reserves the right to supply a higher voltage rating or tighter tolerance part in the same case size, to the same reliability standards.

TAZ SERIES

HRC5000 Medical Implantable Grade



RATING & PART NUMBER REFERENCE		Parametric Specifications by Rating									Typical RMS Ripple Data by Rating						
		Cap @ 120Hz	DC Rated Voltage	ESR @ 100kHz	DCL max			DF Max			Power Dissipation	25°C Ripple Current	85°C Ripple Current	125°C Ripple Current	25°C Ripple Voltage	85°C Ripple Voltage	125°C Ripple Voltage
					+25°C	+85°C	+125°C	+25°C	+(85/125)°C	-55°C							
P/N	Case	µF @ 25°C	V @ +85°C	Ohms @ +25°C	(µA)	(µA)	(µA)	(%)	(%)	(%)	W	A (100kHz)	A (100kHz)	A (100kHz)	V (100kHz)	V (100kHz)	V (100kHz)
TAZD106*015L□L@5 ⁺⁺⁺	D	10	15	2	0.375	3.750	4.500	6	8	8	0.080	0.200	0.180	0.080	0.400	0.360	0.160
TAZD106*015C□L@5 ⁺⁺⁺	D	10	15	6	0.375	3.750	4.500	6	8	8	0.080	0.115	0.104	0.046	0.693	0.624	0.277
TAZE106*015L□L@5 ⁺⁺⁺	E	10	15	1.2	0.375	3.750	4.500	6	8	8	0.090	0.274	0.246	0.110	0.329	0.296	0.131
TAZE106*015C□L@5 ⁺⁺⁺	E	10	15	4	0.375	3.750	4.500	6	8	8	0.090	0.150	0.135	0.060	0.600	0.540	0.240
TAZF106*015L□L@5 ⁺⁺⁺	F	10	15	0.667	0.375	3.750	4.500	6	8	8	0.100	0.387	0.348	0.155	0.258	0.232	0.103
TAZF106*015C□L@5 ⁺⁺⁺	F	10	15	2.5	0.375	3.750	4.500	6	8	8	0.100	0.200	0.180	0.080	0.500	0.450	0.200
TAZE156*015L□L@5 ⁺⁺⁺	E	15	15	1.2	0.563	5.630	6.756	6	8	8	0.090	0.274	0.246	0.110	0.329	0.296	0.131
TAZE156*015C□L@5 ⁺⁺⁺	E	15	15	4	0.563	5.630	6.756	6	8	8	0.090	0.150	0.135	0.060	0.600	0.540	0.240
TAZF226*015L□L@5 ⁺⁺⁺	F	22	15	0.8	0.825	8.250	9.900	8	10	10	0.100	0.354	0.318	0.141	0.283	0.255	0.113
TAZF226*015C□L@5 ⁺⁺⁺	F	22	15	3	0.825	8.250	9.900	8	10	10	0.100	0.183	0.164	0.073	0.548	0.493	0.219
TAZG226*015L□L@5 ⁺⁺⁺	G	22	15	0.275	0.825	8.250	9.900	6	8	8	0.125	0.674	0.607	0.270	0.185	0.167	0.074
TAZG226*015C□L@5 ⁺⁺⁺	G	22	15	1.1	0.825	8.250	9.900	6	8	8	0.125	0.337	0.303	0.135	0.371	0.334	0.148
TAZF336*015L□L@5 ⁺⁺⁺	F	33	15	0.8	1.238	12.380	14.856	6	8	8	0.100	0.354	0.318	0.141	0.283	0.255	0.113
TAZF336*015C□L@5 ⁺⁺⁺	F	33	15	3	1.238	12.380	14.856	6	8	8	0.100	0.183	0.164	0.073	0.548	0.493	0.219
TAZH336*015L□L@5 ⁺⁺⁺	H	33	15	0.18	1.238	12.380	14.856	8	8	10	0.150	0.913	0.822	0.365	0.164	0.148	0.066
TAZH336*015C□L@5 ⁺⁺⁺	H	33	15	0.9	1.238	12.380	14.856	8	8	10	0.150	0.408	0.367	0.163	0.367	0.331	0.147
TAZG476*015L□L@5 ⁺⁺⁺	G	47	15	0.275	1.763	17.630	21.156	8	10	10	0.125	0.674	0.607	0.270	0.185	0.167	0.074
TAZG476*015C□L@5 ⁺⁺⁺	G	47	15	1.1	1.763	17.630	21.156	8	10	10	0.125	0.337	0.303	0.135	0.371	0.334	0.148
TAZH107*015L□L@5 ⁺⁺⁺	H	100	15	0.18	3.750	37.500	45.000	10	12	12	0.150	0.913	0.822	0.365	0.164	0.148	0.066
TAZH107*015C□L@5 ⁺⁺⁺	H	100	15	0.9	3.750	37.500	45.000	10	12	12	0.150	0.408	0.367	0.163	0.367	0.331	0.147
TAZA474*020L□L@5 ⁺⁺⁺	A	0.47	20	7.5	0.100	1.000	1.200	6	8	8	0.050	0.082	0.073	0.033	0.612	0.551	0.245
TAZA474*020C□L@5 ⁺⁺⁺	A	0.47	20	14	0.100	1.000	1.200	6	8	10	0.050	0.060	0.054	0.024	0.837	0.753	0.335
TAZA105*020L□L@5 ⁺⁺⁺	A	1	20	7.5	0.100	1.000	1.200	6	8	8	0.050	0.082	0.073	0.033	0.612	0.551	0.245
TAZA105*020C□L@5 ⁺⁺⁺	A	1	20	15	0.100	1.000	1.200	6	8	8	0.050	0.058	0.052	0.023	0.866	0.779	0.346
TAZB105*020L□L@5 ⁺⁺⁺	B	1	20	4.8	0.100	1.000	1.200	6	8	8	0.070	0.121	0.109	0.048	0.580	0.522	0.232
TAZB105*020C□L@5 ⁺⁺⁺	B	1	20	12	0.100	1.000	1.200	6	8	8	0.070	0.076	0.069	0.031	0.917	0.825	0.367
TAZB155*020L□L@5 ⁺⁺⁺	B	1.5	20	3.6	0.100	1.000	1.200	6	8	8	0.070	0.139	0.125	0.056	0.502	0.452	0.201
TAZB155*020C□L@5 ⁺⁺⁺	B	1.5	20	9	0.100	1.000	1.200	6	8	8	0.070	0.088	0.079	0.035	0.794	0.714	0.317
TAZB225*020L□L@5 ⁺⁺⁺	B	2.2	20	3.6	0.110	1.100	1.320	6	8	8	0.070	0.139	0.125	0.056	0.502	0.452	0.201
TAZB225*020C□L@5 ⁺⁺⁺	B	2.2	20	9	0.110	1.100	1.320	6	8	8	0.070	0.088	0.079	0.035	0.794	0.714	0.317
TAZD225*020L□L@5 ⁺⁺⁺	D	2.2	20	1.7	0.225	2.250	2.700	6	8	8	0.080	0.217	0.195	0.087	0.369	0.332	0.148
TAZD225*020C□L@5 ⁺⁺⁺	D	2.2	20	5	0.225	2.250	2.700	6	8	8	0.080	0.126	0.114	0.051	0.632	0.569	0.253
TAZE335*020L□L@5 ⁺⁺⁺	E	3.3	20	1.2	0.165	1.650	1.980	6	8	8	0.090	0.274	0.246	0.110	0.329	0.296	0.131
TAZE335*020C□L@5 ⁺⁺⁺	E	3.3	20	4	0.165	1.650	1.980	6	8	8	0.090	0.150	0.135	0.060	0.600	0.540	0.240
TAZD475*020L□L@5 ⁺⁺⁺	D	4.7	20	3	0.235	2.350	2.820	6	8	8	0.080	0.163	0.147	0.065	0.490	0.441	0.196
TAZD475*020C□L@5 ⁺⁺⁺	D	4.7	20	6	0.235	2.350	2.820	6	8	8	0.080	0.115	0.104	0.046	0.693	0.624	0.277
TAZE475*020L□L@5 ⁺⁺⁺	E	4.7	20	1.7	0.235	2.350	2.820	6	8	8	0.090	0.230	0.207	0.092	0.391	0.352	0.156
TAZE475*020C□L@5 ⁺⁺⁺	E	4.7	20	6	0.235	2.350	2.820	6	8	8	0.090	0.122	0.110	0.049	0.735	0.661	0.294

All technical data relates to an ambient temperature of +25°C. Capacitance and DF are measured at 120Hz, 0.5V RMS with a maximum DC bias of 2.2 volts. DCL is measured at rated voltage after 5 minutes.

NOTE: KYOCERA AVX reserves the right to supply a higher voltage rating or tighter tolerance part in the same case size, to the same reliability standards.

TAZ SERIES

HRC5000 Medical Implantable Grade



RATING & PART NUMBER REFERENCE		Parametric Specifications by Rating									Typical RMS Ripple Data by Rating						
		Cap @ 120Hz	DC Rated Voltage	ESR @ 100kHz	DCL max			DF Max			Power Dissipation	25°C Ripple Current	85°C Ripple Current	125°C Ripple Current	25°C Ripple Voltage	85°C Ripple Voltage	125°C Ripple Voltage
					+25°C	+85°C	+125°C	+25°C	+(85/125)°C	-55°C							
P/N	Case	µF @ 25°C	V @ +85°C	Ohms @ +25°C	(µA)	(µA)	(µA)	(%)	(%)	(%)	W	A (100kHz)	A (100kHz)	A (100kHz)	V (100kHz)	V (100kHz)	V (100kHz)
TAZD685*020L@5+++	D	6.8	20	2	0.450	4.500	5.400	6	8	8	0.080	0.200	0.180	0.080	0.400	0.360	0.160
TAZD685*020C@5+++	D	6.8	20	4	0.450	4.500	5.400	6	8	8	0.080	0.141	0.127	0.057	0.566	0.509	0.226
TAZE685*020L@5+++	E	6.8	20	1.5	0.450	4.500	5.400	6	8	8	0.090	0.245	0.220	0.098	0.367	0.331	0.147
TAZE685*020C@5+++	E	6.8	20	5	0.450	4.500	5.400	6	8	8	0.090	0.134	0.121	0.054	0.671	0.604	0.268
TAZE106*020L@5+++	E	10	20	1.5	0.500	5.000	6.000	6	8	8	0.090	0.245	0.220	0.098	0.367	0.331	0.147
TAZE106*020C@5+++	E	10	20	5	0.500	5.000	6.000	6	8	8	0.090	0.134	0.121	0.054	0.671	0.604	0.268
TAZF156*020L@5+++	F	15	20	0.8	0.750	7.500	9.000	6	8	8	0.100	0.354	0.318	0.141	0.283	0.255	0.113
TAZF156*020C@5+++	F	15	20	3	0.750	7.500	9.000	6	8	8	0.100	0.183	0.164	0.073	0.548	0.493	0.219
TAZG156*020L@5+++	G	15	20	0.275	0.750	7.500	9.000	6	8	8	0.125	0.674	0.607	0.270	0.185	0.167	0.074
TAZG156*020C@5+++	G	15	20	1.1	0.750	7.500	9.000	6	8	8	0.125	0.337	0.303	0.135	0.371	0.334	0.148
TAZG226*020L@5+++	G	22	20	0.625	1.100	11.000	13.200	6	8	8	0.125	0.447	0.402	0.179	0.280	0.252	0.112
TAZG226*020C@5+++	G	22	20	2.5	1.100	11.000	13.200	6	8	8	0.125	0.224	0.201	0.089	0.559	0.503	0.224
TAZH226*020L@5+++	H	22	20	0.18	1.100	11.000	13.200	6	8	8	0.150	0.913	0.822	0.365	0.164	0.148	0.066
TAZH226*020C@5+++	H	22	20	0.9	1.100	11.000	13.200	6	8	8	0.150	0.408	0.367	0.163	0.367	0.331	0.147
TAZH476*020L@5+++	H	47	20	0.18	2.350	23.500	28.200	8	10	10	0.150	0.913	0.822	0.365	0.164	0.148	0.066
TAZH476*020C@5+++	H	47	20	0.9	2.350	23.500	28.200	8	10	10	0.150	0.408	0.367	0.163	0.367	0.331	0.147
TAZA334*025L@5+++	A	0.33	25	7.5	0.100	1.000	1.200	6	8	8	0.050	0.082	0.073	0.033	0.612	0.551	0.245
TAZA334*025C@5+++	A	0.33	25	15	0.100	1.000	1.200	6	8	8	0.050	0.058	0.052	0.023	0.866	0.779	0.346
TAZB105*025L@5+++	B	1	25	4	0.160	1.600	1.920	6	8	8	0.070	0.132	0.119	0.053	0.529	0.476	0.212
TAZB105*025C@5+++	B	1	25	10	0.160	1.600	1.920	6	8	8	0.070	0.084	0.075	0.033	0.837	0.753	0.335
TAZD155*025L@5+++	D	1.5	25	1.7	0.200	2.000	2.400	6	8	8	0.080	0.217	0.195	0.087	0.369	0.332	0.148
TAZD155*025C@5+++	D	1.5	25	6.5	0.200	2.000	2.400	6	8	8	0.080	0.111	0.100	0.044	0.721	0.649	0.288
TAZD225*025L@5+++	D	2.2	25	2	0.215	2.150	2.580	6	8	8	0.080	0.200	0.180	0.080	0.400	0.360	0.160
TAZD225*025C@5+++	D	2.2	25	6	0.215	2.150	2.580	6	8	8	0.080	0.115	0.104	0.046	0.693	0.624	0.277
TAZE225*025L@5+++	E	2.2	25	1	0.230	2.300	2.760	6	8	8	0.090	0.300	0.270	0.120	0.300	0.270	0.120
TAZE225*025C@5+++	E	2.2	25	3.5	0.230	2.300	2.760	6	8	8	0.090	0.160	0.144	0.064	0.561	0.505	0.224
TAZE335*025L@5+++	E	3.3	25	1.2	0.245	2.450	2.940	6	8	8	0.090	0.274	0.246	0.110	0.329	0.296	0.131
TAZE335*025C@5+++	E	3.3	25	4	0.245	2.450	2.940	6	8	8	0.090	0.150	0.135	0.060	0.600	0.540	0.240
TAZF475*025L@5+++	F	4.7	25	0.7	0.294	2.940	3.528	6	8	8	0.100	0.378	0.340	0.151	0.265	0.238	0.106
TAZF475*025C@5+++	F	4.7	25	2.5	0.294	2.940	3.528	6	8	8	0.100	0.200	0.180	0.080	0.500	0.450	0.200
TAZF685*025L@5+++	F	6.8	25	0.8	0.425	4.250	5.100	6	8	8	0.100	0.354	0.318	0.141	0.283	0.255	0.113
TAZF685*025C@5+++	F	6.8	25	3	0.425	4.250	5.100	6	8	8	0.100	0.183	0.164	0.073	0.548	0.493	0.219
TAZG106*025L@5+++	G	10	25	0.35	0.625	6.250	7.500	6	8	8	0.125	0.598	0.538	0.239	0.209	0.188	0.084
TAZG106*025C@5+++	G	10	25	1.4	0.625	6.250	7.500	6	8	8	0.125	0.299	0.269	0.120	0.418	0.376	0.167
TAZH226*025L@5+++	H	22	25	0.18	1.375	13.750	16.500	6	8	8	0.150	0.913	0.822	0.365	0.164	0.148	0.066
TAZH226*025C@5+++	H	22	25	0.9	1.375	13.750	16.500	6	8	8	0.150	0.408	0.367	0.163	0.367	0.331	0.147
TAZA224*035L@5+++	A	0.22	35	12	0.100	1.000	1.200	6	8	8	0.050	0.065	0.058	0.026	0.775	0.697	0.310
TAZA224*035C@5+++	A	0.22	35	18	0.100	1.000	1.200	6	8	8	0.050	0.053	0.047	0.021	0.949	0.854	0.379

All technical data relates to an ambient temperature of +25°C. Capacitance and DF are measured at 120Hz, 0.5V RMS with a maximum DC bias of 2.2 volts. DCL is measured at rated voltage after 5 minutes.

NOTE: KYOCERA AVX reserves the right to supply a higher voltage rating or tighter tolerance part in the same case size, to the same reliability standards.

TAZ SERIES

HRC5000 Medical Implantable Grade



RATING & PART NUMBER REFERENCE		Parametric Specifications by Rating									Typical RMS Ripple Data by Rating						
		Cap @ 120Hz	DC Rated Voltage	ESR @ 100kHz	DCL max			DF Max			Power Dissipation	25°C Ripple Current	85°C Ripple Current	125°C Ripple Current	25°C Ripple Voltage	85°C Ripple Voltage	125°C Ripple Voltage
					+25°C	+85°C	+125°C	+25°C	+(85/125)°C	-55°C							
P/N	Case	µF @ 25°C	V @ +85°C	Ohms @ +25°C	(µA)	(µA)	(µA)	(%)	(%)	(%)	W	A (100kHz)	A (100kHz)	A (100kHz)	V (100kHz)	V (100kHz)	V (100kHz)
TAZB474*035L□L@5 ⁺⁺⁺	B	0.47	35	6.8	0.100	1.000	1.200	6	8	8	0.070	0.101	0.091	0.041	0.690	0.621	0.276
TAZB474*035C□L@5 ⁺⁺⁺	B	0.47	35	10	0.100	1.000	1.200	6	8	8	0.070	0.084	0.075	0.033	0.837	0.753	0.335
TAZD105*035L□L@5 ⁺⁺⁺	D	1	35	2.2	0.100	1.000	1.200	6	8	8	0.080	0.191	0.172	0.076	0.420	0.378	0.168
TAZD105*035C□L@5 ⁺⁺⁺	D	1	35	6.5	0.100	1.000	1.200	6	8	8	0.080	0.111	0.100	0.044	0.721	0.649	0.288
TAZF335*035L□L@5 ⁺⁺⁺	F	3.3	35	0.7	0.289	2.890	3.468	6	8	8	0.100	0.378	0.340	0.151	0.265	0.238	0.106
TAZF335*035C□L@5 ⁺⁺⁺	F	3.3	35	2.5	0.289	2.890	3.468	6	8	8	0.100	0.200	0.180	0.080	0.500	0.450	0.200
TAZH106*035L□L@5 ⁺⁺⁺	H	10	35	0.5	0.875	8.750	10.500	8	10	10	0.150	0.548	0.493	0.219	0.274	0.246	0.110
TAZH106*035C□L@5 ⁺⁺⁺	H	10	35	0.9	0.875	8.750	10.500	8	10	10	0.150	0.408	0.367	0.163	0.367	0.331	0.147
TAZA104*050L□L@5 ⁺⁺⁺	A	0.1	50	12	0.100	1.000	1.200	6	8	8	0.050	0.065	0.058	0.026	0.775	0.697	0.310
TAZA104*050C□L@5 ⁺⁺⁺	A	0.1	50	22	0.100	1.000	1.200	6	8	8	0.050	0.048	0.043	0.019	1.049	0.944	0.420
TAZA154*050L□L@5 ⁺⁺⁺	A	0.15	50	12	0.100	1.000	1.200	6	8	8	0.050	0.065	0.058	0.026	0.775	0.697	0.310
TAZA154*050C□L@5 ⁺⁺⁺	A	0.15	50	17	0.100	1.000	1.200	6	8	8	0.050	0.054	0.049	0.022	0.922	0.830	0.369
TAZE105*050L□L@5 ⁺⁺⁺	E	1	50	1.7	0.125	1.250	1.500	6	8	8	0.090	0.230	0.207	0.092	0.391	0.352	0.156
TAZE105*050C□L@5 ⁺⁺⁺	E	1	50	6	0.125	1.250	1.500	6	8	8	0.090	0.122	0.110	0.049	0.735	0.661	0.294
TAZF225*050L□L@5 ⁺⁺⁺	F	2.2	50	0.7	0.275	2.750	3.300	6	8	8	0.100	0.378	0.340	0.151	0.265	0.238	0.106
TAZF225*050C□L@5 ⁺⁺⁺	F	2.2	50	2.5	0.275	2.750	3.300	6	8	8	0.100	0.200	0.180	0.080	0.500	0.450	0.200
TAZG335*050L□L@5 ⁺⁺⁺	G	3.3	50	0.5	0.413	4.130	4.956	6	8	8	0.125	0.500	0.450	0.200	0.250	0.225	0.100
TAZG335*050C□L@5 ⁺⁺⁺	G	3.3	50	2	0.413	4.130	4.956	6	8	8	0.125	0.250	0.225	0.100	0.500	0.450	0.200

All technical data relates to an ambient temperature of +25°C. Capacitance and DF are measured at 120Hz, 0.5V RMS with a maximum DC bias of 2.2 volts. DCL is measured at rated voltage after 5 minutes.

NOTICE: The specifications set forth herein are subject to change without notice and are typical and may not apply to all applications. KYOCERA AVX does not warrant or guarantee any aspect of the operation or use of any product except as explicitly set forth in the product specification. Unless specifically agreed to in writing, Seller has not tested or certified its products, services or deliverables for use in high risk applications including medical life support, medical device, direct physical patient contact, water treatment, nuclear facilities, weapon systems, mass and air transportation control, flammable environments, or any other potentially life critical uses. By ordering or using KYOCERA AVX products, the user understands and agrees that KYOCERA AVX makes no assurances that the products, services or deliverables are suitable for any high risk uses.

Under no circumstances does Seller warrant or guarantee suitability for any customer design or manufacturing process. Any statements herein are believed to be true, but are presented without warranty of any kind, explicit or implied. Statements concerning use of KYOCERA AVX products are made without any representation that such use is a non-infringing use or is consistent with any regulation. Users should not assume that any or all safety measures are indicated.

NOTE: KYOCERA AVX reserves the right to supply a higher voltage rating or tighter tolerance part in the same case size, to the same reliability standards.

TAZ SERIES

T4Z HRC4000 Medical Grade for Non-Critical Applications



GENERAL DESCRIPTION

The T4Z HRC4000 Medical Grade series is designed for use in non-critical medical applications. The T4Z product line is based on the MIL-PRF- 55365 case sizes A-H. Statistical screening is used resulting in DC leakage levels significantly lower than commercial solid tantalum capacitors.

These components are manufactured and tested in KYOCERA AVX's high reliability tantalum capacitor plant in Biddeford, Maine which is ISO 13485 certified. Reliability grading to implantable device standards and surge current testing options per MIL-PRF-55365 are available along with several plating options including tin/lead solder, 100% tin, or gold terminations.

To request a specific rating or for more information on HRC4000 testing details please contact the factory.

APPLICATIONS

Medical Devices for Non-Critical Applications

- Implantable, Non-Life Sustaining Devices
e.g. implanted temporary cardiac monitor, insulin pumps
- External, Life Sustaining Devices
e.g. heart pump external controller
- External Devices
e.g. patient monitoring, diagnostic equipment

MARKING

(White marking on black body)



Polarity Stripe (+)

Capacitance Code

Rated Voltage

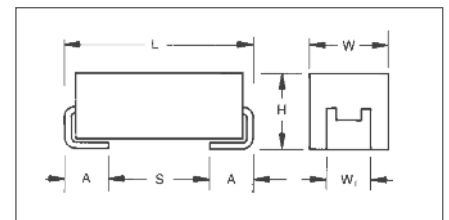

CASE DIMENSIONS:

millimeters (inches)

Case Code	Length (L) ±0.38 (0.015)	Width (W) ±0.38 (0.015)	Height (H) ±0.38 (0.015)	Term. Width (W _t)	Term. Length (A) +0.25/-0.13 (+0.010/-0.005)	S min	Typical Weight (g)
A	2.54 (0.100)	1.27 (0.050)	1.27 (0.050)	1.27±0.13 (0.050±0.005)	0.76 (0.030)	0.38 (0.015)	0.016
B	3.81 (0.150)	1.27 (0.050)	1.27 (0.050)	1.27±0.13 (0.050±0.005)	0.76 (0.030)	1.65 (0.065)	0.025
C	5.08 (0.200)	1.27 (0.050)	1.27 (0.050)	1.27±0.13 (0.050±0.005)	0.76 (0.030)	2.92 (0.115)	0.035
D	3.81 (0.150)	2.54 (0.100)	1.27 (0.050)	2.41+0.13/-0.25 (0.095+0.005/-0.010)	0.76 (0.030)	1.65 (0.065)	0.045
E	5.08 (0.200)	2.54 (0.100)	1.27 (0.050)	2.41+0.13/-0.25 (0.095+0.005/-0.010)	0.76 (0.030)	2.92 (0.115)	0.065
F	5.59 (0.220)	3.43 (0.135)	1.78 (0.070)	3.30±0.13 (0.130±0.005)	0.76 (0.030)	3.43 (0.135)	0.125
G	6.73 (0.265)	2.79 (0.110)	2.79 (0.110)	2.67±0.13 (0.105±0.005)	1.27 (0.050)	3.56 (0.140)	0.205
H	7.24 (0.285)	3.81 (0.150)	2.79 (0.110)	3.68+0.13/-0.51 (0.145+0.005/-0.020)	1.27 (0.050)	4.06 (0.160)	0.335

TAZ SERIES

T4Z HRC4000 Medical Grade for Non-Critical Applications

CAPACITANCE AND RATED VOLTAGE, V_R (VOLTAGE CODE) RANGE (LETTER DENOTES CASE SIZE)

Capacitance		Rated Voltage								
μF	Code	4V	6V	10V	12V	15V	20V	25V	35V	50V
0.10	104									A
0.15	154									A
0.22	224								A	
0.33	334							A		
0.47	474						A		B	
0.68	684					A				
1	105			A		A	A/B	B	D	E
1.5	155		A	A			B	D		
2.2	225	A	A	A/B		A/B/C	B/D	D/E		F
3.3	335		A/B	A/B		B/D	E	E	F	G
4.7	475	A/B	A	B/D		B/D/E	D/E	F		
6	605									
6.8	685	A	D	B/D/E			D/E	F		
10	106	D	B/D/E	B/D/E		D/E/F	E	G	H	
14	146			E						
15	156		B/D/F	D/E/F		E	F/G			
22	226		F	D/E/F	E	F/G	G/H	H		
33	336	E/F	E	F/G		F/H				
47	476	E	E/F/G	F/G/H		G	H			
68	686	E/G	E/F/G/H	G						
100	107	F	G	H		H				
150	157		G	H						
220	227			H						
300	307		H							
330	337		H							

HOW TO ORDER

T4Z	E	106	*	10	C	□	L	@	4	^	++
Type	Case Size	Capacitance Code	Capacitance Tolerance	Voltage Code	ESR	Packaging	Inspection Level	Reliability Grade	Qualification Level	Termination Finish	Surge Test Option
		pF code: 1st two digits represent significant figures 3rd digit represents multiplier (number of zeros to follow)	K = $\pm 10\%$ M = $\pm 20\%$	004 = 4Vdc 006 = 6Vdc 010 = 10Vdc 015 = 15Vdc 020 = 20Vdc 025 = 25Vdc 035 = 35Vdc 050 = 50Vdc	C = Std ESR	B = Bulk R = 7" T&R W = Waffle	L = Group A	B = Weibull B 0.1%/1000 hrs. 90% conf.	4 = HRC4000	H = Solder Plated 0 = Solder Fused 9 = Gold Plated 7 = 100% Tin	00 = None 23 = 10 Cycles, +25°C 24 = 10 Cycles, -55°C & +85°C 45 = 10 cycles, -55°C & +85°C before burn-in

TECHNICAL SPECIFICATIONS

Technical Data:	Unless otherwise specified, all technical data relate to an ambient temperature of 25°C									
Capacitance Range:	0.10 μF to 330 μF									
Capacitance Tolerance:	$\pm 10\%$; $\pm 20\%$									
Rated Voltage (V_R)	at $\leq 85^\circ\text{C}$:	4	6	10	15	20	25	35	50	
Category Voltage (V_C)	at $\leq 125^\circ\text{C}$:	2.7	4	6.7	10	13.3	16.7	23.3	33.3	
Surge Voltage (V_S)	at $\leq 85^\circ\text{C}$:	5.3	8	13.3	20	26.7	33.3	46.7	66.7	
applies to Weibull parts only	at $\leq 125^\circ\text{C}$:	3.5	5.3	8.7	13.3	17.8	22.2	31.1	44.5	
Temperature Range:	-55°C to +125°C									

TAZ SERIES

T4Z HRC4000 Medical Grade for Non-Critical Applications



RATING & PART NUMBER REFERENCE		Parametric Specifications by Rating									Typical RMS Ripple Data by Rating						
		Cap @ 120Hz	DC Rated Voltage	ESR @ 100kHz	DCL max			DF Max			Power Dissipation	25°C	85°C	125°C	25°C	85°C	125°C
					+25°C	+85°C	+125°C	+25°C	+(85/125)°C	-55°C		Ripple Current	Ripple Current	Ripple Current	Ripple Voltage	Ripple Voltage	Ripple Voltage
P/N	Case	µF @ 25°C	V @ +85°C	Ohms @ +25°C	(µA)	(µA)	(µA)	(%)	(%)	(%)	W	A (100kHz)	A (100kHz)	A (100kHz)	V (100kHz)	V (100kHz)	V (100kHz)
T4ZA225*004C□L@4 ⁺ ++	A	2.2	4	8	0.100	1.000	1.200	6	8	8	0.05	0.079	0.071	0.032	0.632	0.569	0.253
T4ZA475*004C□L@4 ⁺ ++	A	4.7	4	12	0.100	1.000	1.200	6	8	8	0.05	0.065	0.058	0.026	0.775	0.697	0.310
T4ZB475*004C□L@4 ⁺ ++	B	4.7	4	8	0.100	1.000	1.200	6	8	8	0.07	0.094	0.084	0.037	0.748	0.673	0.299
T4ZA685*004C□L@4 ⁺ ++	A	6.8	4	12	0.136	1.360	1.632	6	8	8	0.05	0.065	0.058	0.026	0.775	0.697	0.310
T4ZD106*004C□L@4 ⁺ ++	D	10	4	4	0.200	2.000	2.400	8	8	10	0.08	0.141	0.127	0.057	0.566	0.509	0.226
T4ZE336*004C□L@4 ⁺ ++	E	33	4	3	0.660	6.600	7.920	8	10	12	0.09	0.173	0.156	0.069	0.520	0.468	0.208
T4ZF336*004C□L@4 ⁺ ++	F	33	4	2.2	0.660	.600	7.920	8	10	12	0.1	0.213	0.192	0.085	0.469	0.422	0.188
T4ZE476*004C□L@4 ⁺ ++	E	47	4	3	0.940	9.400	11.280	8	10	12	0.09	0.173	0.156	0.069	0.520	0.468	0.208
T4ZE686*004C□L@4 ⁺ ++	E	68	4	3	1.360	13.600	16.320	8	10	12	0.09	0.173	0.156	0.069	0.520	0.468	0.208
T4ZG686*004C□L@4 ⁺ ++	G	68	4	1.1	1.360	13.600	16.320	10	12	12	0.125	0.337	0.303	0.135	0.371	0.334	0.148
T4ZF107*004C□L@4 ⁺ ++	F	100	4	2	2.000	20.000	24.000	10	12	12	0.1	0.224	0.201	0.089	0.447	0.402	0.179
T4ZA155*006C□L@4 ⁺ ++	A	1.5	6	8	0.100	1.000	1.200	6	8	8	0.05	0.079	0.071	0.032	0.632	0.569	0.253
T4ZA225*006C□L@4 ⁺ ++	A	2.2	6	12	0.100	1.000	1.200	6	8	8	0.05	0.065	0.058	0.026	0.775	0.697	0.310
T4ZA335*006C□L@4 ⁺ ++	A	3.3	6	12	0.100	1.000	1.200	6	8	8	0.05	0.065	0.058	0.026	0.775	0.697	0.310
T4ZB335*006C□L@4 ⁺ ++	B	3.3	6	8	0.100	1.000	1.200	6	8	8	0.07	0.094	0.084	0.037	0.748	0.673	0.299
T4ZA475*006C□L@4 ⁺ ++	A	4.7	6	12	0.141	1.410	1.692	6	8	8	0.05	0.065	0.058	0.026	0.775	0.697	0.310
T4ZD685*006C□L@4 ⁺ ++	D	6.8	6	4.5	0.204	2.040	2.448	6	8	8	0.08	0.133	0.120	0.053	0.600	0.540	0.240
T4ZB106*006C□L@4 ⁺ ++	B	10	6	8	0.300	3.000	3.600	6	8	8	0.07	0.094	0.084	0.037	0.748	0.673	0.299
T4ZD106*006C□L@4 ⁺ ++	D	10	6	6	0.300	3.000	3.600	6	8	8	0.08	0.115	0.104	0.046	0.693	0.624	0.277
T4ZE106*006C□L@4 ⁺ ++	E	10	6	3.5	0.300	3.000	3.600	8	10	12	0.09	0.160	0.144	0.064	0.561	0.505	0.224
T4ZB156*006C□L@4 ⁺ ++	B	15	6	8	0.450	4.500	5.400	8	10	10	0.07	0.094	0.084	0.037	0.748	0.673	0.299
T4ZD156*006C□L@4 ⁺ ++	D	15	6	5	0.450	4.500	5.400	8	10	12	0.08	0.126	0.114	0.051	0.632	0.569	0.253
T4ZF156*006C□L@4 ⁺ ++	F	15	6	0.3	0.450	4.500	5.400	6	8	8	0.1	0.577	0.520	0.231	0.173	0.156	0.069
T4ZF226*006C□L@4 ⁺ ++	F	22	6	2.2	0.660	6.600	7.920	8	10	12	0.1	0.213	0.192	0.085	0.469	0.422	0.188
T4ZE336*006C□L@4 ⁺ ++	E	33	6	3.5	0.990	9.900	11.880	6	8	8	0.09	0.160	0.144	0.064	0.561	0.505	0.224
T4ZE476*006C□L@4 ⁺ ++	E	47	6	5	1.410	14.100	16.920	6	8	8	0.09	0.134	0.121	0.054	0.671	0.604	0.268
T4ZF476*006C□L@4 ⁺ ++	F	47	6	3.5	1.410	14.100	16.920	8	10	12	0.1	0.169	0.152	0.068	0.592	0.532	0.237
T4ZG476*006C□L@4 ⁺ ++	G	47	6	1.1	1.410	14.100	16.920	10	12	12	0.125	0.337	0.303	0.135	0.371	0.334	0.148
T4ZE686*006C□L@4 ⁺ ++	E	68	6	2	2.040	20.400	24.480	10	12	12	0.09	0.212	0.191	0.085	0.424	0.382	0.170
T4ZF686*006C□L@4 ⁺ ++	F	68	6	1.5	2.040	20.400	24.480	10	12	12	0.1	0.258	0.232	0.103	0.387	0.349	0.155
T4ZG686*006C□L@4 ⁺ ++	G	68	6	1	2.040	20.400	24.480	10	12	12	0.125	0.354	0.318	0.141	0.354	0.318	0.141
T4ZH686*006C□L@4 ⁺ ++	H	68	6	0.9	2.040	20.400	24.480	10	12	12	0.15	0.408	0.367	0.163	0.367	0.331	0.147
T4ZG107*006C□L@4 ⁺ ++	G	100	6	1.1	3.000	30.000	36.000	10	12	12	0.125	0.337	0.303	0.135	0.371	0.334	0.148
T4ZG157*006C□L@4 ⁺ ++	G	150	6	1.1	4.500	45.000	54.000	10	12	12	0.125	0.337	0.303	0.135	0.371	0.334	0.148
T4ZH307*006C□L@4 ⁺ ++	H	300	6	0.9	9.000	90.000	108.000	15	18	18	0.15	0.408	0.367	0.163	0.367	0.331	0.147
T4ZH337*006C□L@4 ⁺ ++	H	330	6	0.9	9.900	99.000	118.800	10	12	12	0.15	0.408	0.367	0.163	0.367	0.331	0.147
T4ZA105*010C□L@4 ⁺ ++	A	1	10	10	0.100	1.000	1.200	6	8	8	0.05	0.071	0.064	0.028	0.707	0.636	0.283
T4ZA155*010C□L@4 ⁺ ++	A	1.5	10	12	0.100	1.000	1.200	6	8	8	0.05	0.065	0.058	0.026	0.775	0.697	0.310
T4ZA225*010C□L@4 ⁺ ++	A	2.2	10	12	0.110	1.100	1.320	6	8	8	0.05	0.065	0.058	0.026	0.775	0.697	0.310
T4ZB225*010C□L@4 ⁺ ++	B	2.2	10	8	0.110	1.100	1.320	6	8	8	0.07	0.094	0.084	0.037	0.748	0.673	0.299

All technical data relates to an ambient temperature of +25°C. Capacitance and DF are measured at 120Hz, 0.5V RMS with a maximum DC bias of 2.2 volts. DCL is measured at rated voltage after 5 minutes.

NOTE: KYOCERA AVX reserves the right to supply a higher voltage rating or tighter tolerance part in the same case size, to the same reliability standards.

TAZ SERIES

T4Z HRC4000 Medical Grade for Non-Critical Applications



RATING & PART NUMBER REFERENCE		Parametric Specifications by Rating									Typical RMS Ripple Data by Rating						
		Cap @ 120Hz	DC Rated Voltage	ESR @ 100kHz	DCL max			DF Max			Power Dissipation	25°C	85°C	125°C	25°C	85°C	125°C
					+25°C	+85°C	+125°C	+25°C	+(85/125)°C	-55°C		Ripple Current	Ripple Current	Ripple Current	Ripple Voltage	Ripple Voltage	Ripple Voltage
P/N	Case	µF @ 25°C	V @ +85°C	Ohms @ +25°C	(µA)	(µA)	(µA)	(%)	(%)	(%)	W	A (100kHz)	A (100kHz)	A (100kHz)	V (100kHz)	V (100kHz)	V (100kHz)
T4ZA335*010C□L@4^++	A	3.3	10	12	0.165	1.650	1.980	6	8	8	0.05	0.065	0.058	0.026	0.775	0.697	0.310
T4ZB335*010C□L@4^++	B	3.3	10	18	0.165	1.650	1.980	6	8	8	0.07	0.062	0.056	0.025	1.122	1.010	0.449
T4ZB475*010C□L@4^++	B	4.7	10	8	0.235	2.350	2.820	6	8	8	0.07	0.094	0.084	0.037	0.748	0.673	0.299
T4ZD475*010C□L@4^++	D	4.7	10	4.5	0.235	2.350	2.820	6	8	8	0.08	0.133	0.120	0.053	0.600	0.540	0.240
T4ZB685*010C□L@4^++	B	6.8	10	8	0.340	3.400	4.080	6	8	8	0.07	0.094	0.084	0.037	0.748	0.673	0.299
T4ZD685*010C□L@4^++	D	6.8	10	5	0.340	3.400	4.080	6	8	8	0.08	0.126	0.114	0.051	0.632	0.569	0.253
T4ZE685*010C□L@4^++	E	6.8	10	3.5	0.340	3.400	4.080	6	8	8	0.09	0.160	0.144	0.064	0.561	0.505	0.224
T4ZB106*010C□L@4^++	B	10	10	8	0.500	5.000	6.000	8	10	10	0.07	0.094	0.084	0.037	0.748	0.673	0.299
T4ZD106*010C□L@4^++	D	10	10	4	0.500	5.000	6.000	6	8	8	0.08	0.141	0.127	0.057	0.566	0.509	0.226
T4ZE106*010C□L@4^++	E	10	10	3.5	0.500	5.000	6.000	6	8	8	0.09	0.160	0.144	0.064	0.561	0.505	0.224
T4ZE146*010C□L@4^++	E	14	10	3	0.700	7.000	8.400	6	8	8	0.09	0.173	0.156	0.069	0.520	0.468	0.208
T4ZD156*010C□L@4^++	D	15	10	5	0.750	7.500	9.000	6	8	8	0.08	0.126	0.114	0.051	0.632	0.569	0.253
T4ZE156*010C□L@4^++	E	15	10	3	0.750	7.500	9.000	8	10	10	0.09	0.173	0.156	0.069	0.520	0.468	0.208
T4ZF156*010C□L@4^++	F	15	10	2.5	0.750	7.500	9.000	8	8	10	0.1	0.200	0.180	0.080	0.500	0.450	0.200
T4ZD226*010C□L@4^++	D	22	10	8	1.100	11.000	13.200	6	8	8	0.08	0.100	0.090	0.040	0.800	0.720	0.320
T4ZE226*010C□L@4^++	E	22	10	2	1.100	11.000	13.200	8	10	10	0.09	0.212	0.191	0.085	0.424	0.382	0.170
T4ZF226*010C□L@4^++	F	22	10	3	1.100	11.000	13.200	8	10	10	0.1	0.183	0.164	0.073	0.548	0.493	0.219
T4ZF336*010C□L@4^++	F	33	10	1.5	1.650	16.500	18.800	8	10	10	0.1	0.258	0.232	0.103	0.387	0.349	0.155
T4ZG336*010C□L@4^++	G	33	10	1.1	1.650	16.500	19.800	10	12	12	0.125	0.337	0.303	0.135	0.371	0.334	0.148
T4ZF476*010C□L@4^++	F	47	10	1.5	2.350	23.500	28.200	10	12	12	0.1	0.258	0.232	0.103	0.387	0.349	0.155
T4ZG476*010C□L@4^++	G	47	10	1	2.350	23.500	28.200	10	12	12	0.125	0.354	0.318	0.141	0.354	0.318	0.141
T4ZH476*010C□L@4^++	H	47	10	0.9	2.350	23.500	28.200	10	12	12	0.15	0.408	0.367	0.163	0.367	0.331	0.147
T4ZG686*010C□L@4^++	G	68	10	1.1	3.400	34.000	40.800	10	12	12	0.125	0.337	0.303	0.135	0.371	0.334	0.148
T4ZH107*010C□L@4^++	H	100	10	0.9	5.000	50.000	60.000	10	12	12	0.15	0.408	0.367	0.163	0.367	0.331	0.147
T4ZH157*010C□L@4^++	H	150	10	0.9	7.500	75.000	90.000	10	12	12	0.15	0.408	0.367	0.163	0.367	0.331	0.147
T4ZH227*010C□L@4^++	H	220	10	0.9	11.000	110.000	132.000	10	12	12	0.15	0.408	0.367	0.163	0.367	0.331	0.147
T4ZE226*012C□L@4^++	E	22	12	0.5	1.320	13.200	15.840	6	8	8	0.09	0.424	0.382	0.170	0.212	0.191	0.085
T4ZA684*015C□L@4^++	A	0.68	15	12	0.100	1.000	1.200	6	8	8	0.05	0.065	0.058	0.026	0.775	0.697	0.310
T4ZA105*015C□L@4^++	A	1	15	15	0.100	1.000	1.200	6	8	8	0.05	0.058	0.052	0.023	0.866	0.779	0.346
T4ZA225*015C□L@4^++	A	2.2	15	15	0.165	1.650	1.980	6	8	8	0.05	0.058	0.052	0.023	0.866	0.779	0.346
T4ZB225*015C□L@4^++	B	2.2	15	5.5	0.165	1.650	1.980	6	8	8	0.07	0.113	0.102	0.045	0.620	0.558	0.248
T4ZC225*015C□L@4^++	C	2.2	15	5.5	0.165	1.650	1.980	6	8	8	0.075	0.117	0.105	0.047	0.642	0.578	0.257
T4ZB335*015C□L@4^++	B	3.3	15	9	0.248	2.475	2.970	6	8	8	0.07	0.088	0.079	0.035	0.794	0.714	0.317
T4ZD335*015C□L@4^++	D	3.3	15	5	0.248	2.475	2.970	6	8	8	0.08	0.126	0.114	0.051	0.632	0.569	0.253
T4ZB475*015C□L@4^++	B	4.7	15	5	0.353	3.525	4.230	6	8	8	0.07	0.118	0.106	0.047	0.592	0.532	0.237
T4ZD475*015C□L@4^++	D	4.7	15	6	0.353	3.525	4.230	6	8	8	0.08	0.115	0.104	0.046	0.693	0.624	0.277
T4ZE475*015C□L@4^++	E	4.7	15	4	0.353	3.525	4.230	6	8	8	0.09	0.150	0.135	0.060	0.600	0.540	0.240
T4ZD106*015C□L@4^++	D	10	15	6	0.750	7.500	9.000	6	8	8	0.08	0.115	0.104	0.046	0.693	0.624	0.277
T4ZE106*015C□L@4^++	E	10	15	4	0.750	7.500	9.000	6	8	8	0.09	0.150	0.135	0.060	0.600	0.540	0.240

All technical data relates to an ambient temperature of +25°C. Capacitance and DF are measured at 120Hz, 0.5V RMS with a maximum DC bias of 2.2 volts. DCL is measured at rated voltage after 5 minutes.

NOTE: KYOCERA AVX reserves the right to supply a higher voltage rating or tighter tolerance part in the same case size, to the same reliability standards.

TAZ SERIES

T4Z HRC4000 Medical Grade for Non-Critical Applications



RATING & PART NUMBER REFERENCE		Parametric Specifications by Rating									Typical RMS Ripple Data by Rating						
		Cap @ 120Hz	DC Rated Voltage	ESR @ 100kHz	DCL max			DF Max			Power Dissipation	25°C	85°C	125°C	25°C	85°C	125°C
					+25°C	+85°C	+125°C	+25°C	+(85/125)°C	-55°C		Ripple Current	Ripple Current	Ripple Current	Ripple Voltage	Ripple Voltage	Ripple Voltage
P/N	Case	µF @ 25°C	V @ +85°C	Ohms @ +25°C	(µA)	(µA)	(µA)	(%)	(%)	(%)	W	A (100kHz)	A (100kHz)	A (100kHz)	V (100kHz)	V (100kHz)	V (100kHz)
T4ZF106*015C□L@4^++	F	10	15	2.5	0.750	7.500	9.000	6	8	8	0.1	0.200	0.180	0.080	0.500	0.450	0.200
T4ZE156*015C□L@4^++	E	15	15	4	1.125	11.250	13.500	6	8	8	0.09	0.150	0.135	0.060	0.600	0.540	0.240
T4ZF226*015C□L@4^++	F	22	15	3	1.650	16.500	19.800	8	10	10	0.1	0.183	0.164	0.073	0.548	0.493	0.219
T4ZG226*015C□L@4^++	G	22	15	1.1	1.650	16.500	19.800	6	8	8	0.125	0.337	0.303	0.135	0.371	0.334	0.148
T4ZF336*015C□L@4^++	F	33	15	3	2.475	24.750	29.700	6	8	8	0.1	0.183	0.164	0.073	0.548	0.493	0.219
T4ZH336*015C□L@4^++	H	33	15	0.9	2.475	24.750	29.700	8	8	10	0.15	0.408	0.367	0.163	0.367	0.331	0.147
T4ZG476*015C□L@4^++	G	47	15	1.1	3.525	35.250	42.300	8	10	10	0.125	0.337	0.303	0.135	0.371	0.334	0.148
T4ZH107*015C□L@4^++	H	100	15	0.9	7.500	75.000	90.000	10	12	12	0.15	0.408	0.367	0.163	0.367	0.331	0.147
T4ZA474*020C□L@4^++	A	0.47	20	14	0.100	1.000	1.200	8	8	10	0.05	0.060	0.054	0.024	0.837	0.753	0.335
T4ZA105*020C□L@4^++	A	1	20	15	0.100	1.000	1.200	6	8	8	0.05	0.058	0.052	0.023	0.866	0.779	0.346
T4ZB105*020C□L@4^++	B	1	20	12	0.100	1.000	1.200	6	8	8	0.07	0.076	0.069	0.031	0.917	0.825	0.367
T4ZB155*020C□L@4^++	B	1.5	20	9	0.150	1.500	1.800	6	8	8	0.07	0.088	0.079	0.035	0.794	0.714	0.317
T4ZB225*020C□L@4^++	B	2.2	20	9	0.220	2.200	2.640	6	8	8	0.07	0.088	0.079	0.035	0.794	0.714	0.317
T4ZD225*020C□L@4^++	D	2.2	20	5	0.220	2.200	2.640	6	8	8	0.08	0.126	0.114	0.051	0.632	0.569	0.253
T4ZE335*020C□L@4^++	E	3.3	20	4	0.330	3.300	3.960	6	8	8	0.09	0.150	0.135	0.060	0.600	0.540	0.240
T4ZD475*020C□L@4^++	D	4.7	20	6	0.470	4.700	5.640	6	8	8	0.08	0.115	0.104	0.046	0.693	0.624	0.277
T4ZE475*020C□L@4^++	E	4.7	20	6	0.470	4.700	5.640	6	8	8	0.09	0.122	0.110	0.049	0.735	0.661	0.294
T4ZD685*020C□L@4^++	D	6.8	20	4	0.680	6.800	8.160	6	8	8	0.08	0.141	0.127	0.057	0.566	0.509	0.226
T4ZE685*020C□L@4^++	E	6.8	20	5	0.680	6.800	8.160	6	8	8	0.09	0.134	0.121	0.054	0.671	0.604	0.268
T4ZE106*020C□L@4^++	E	10	20	5	1.000	10.000	12.000	6	8	8	0.09	0.134	0.121	0.054	0.671	0.604	0.268
T4ZF156*020C□L@4^++	F	15	20	3	1.500	15.000	18.000	6	8	8	0.1	0.183	0.164	0.073	0.548	0.493	0.219
T4ZG156*020C□L@4^++	G	15	20	1.1	1.500	15.000	18.000	6	8	8	0.125	0.337	0.303	0.135	0.371	0.334	0.148
T4ZG226*020C□L@4^++	G	22	20	2.5	2.200	22.000	26.400	6	8	8	0.125	0.224	0.201	0.089	0.559	0.503	0.224
T4ZH226*020C□L@4^++	H	22	20	0.9	2.200	22.000	26.400	6	8	8	0.15	0.408	0.367	0.163	0.367	0.331	0.147
T4ZH476*020C□L@4^++	H	47	20	0.9	4.700	47.000	56.400	8	10	10	0.15	0.408	0.367	0.163	0.367	0.331	0.147
T4ZA334*025C□L@4^++	A	0.33	25	15	0.100	1.000	1.200	6	8	8	0.05	0.058	0.052	0.023	0.866	0.779	0.346
T4ZB105*025C□L@4^++	B	1	25	10	0.125	1.250	1.500	6	8	8	0.07	0.084	0.075	0.033	0.837	0.753	0.335
T4ZD155*025C□L@4^++	D	1.5	25	6.5	0.188	1.875	2.250	6	8	8	0.08	0.111	0.100	0.044	0.721	0.649	0.288
T4ZD225*025C□L@4^++	D	2.2	25	6	0.275	2.750	3.300	6	8	8	0.08	0.115	0.104	0.046	0.693	0.624	0.277
T4ZE225*025C□L@4^++	E	2.2	25	3.5	0.275	2.750	3.300	6	8	8	0.09	0.160	0.144	0.064	0.561	0.505	0.224
T4ZE335*025C□L@4^++	E	3.3	25	4	0.413	4.125	4.950	6	8	8	0.09	0.150	0.135	0.060	0.600	0.540	0.240
T4ZF475*025C□L@4^++	F	4.7	25	2.5	0.588	5.875	7.050	6	8	8	0.1	0.200	0.180	0.080	0.500	0.450	0.200
T4ZF685*025C□L@4^++	F	6.8	25	3	0.850	8.5001	0.200	6	8	8	0.1	0.183	0.164	0.073	0.548	0.493	0.219
T4ZG106*025C□L@4^++	G	10	25	1.4	1.250	12.500	15.000	6	8	8	0.125	0.299	0.269	0.120	0.418	0.376	0.167
T4ZH226*025C□L@4^++	H	22	25	0.9	2.750	27.500	33.000	6	8	8	0.15	0.408	0.367	0.163	0.367	0.331	0.147
T4ZA224*035C□L@4^++	A	0.22	35	18	0.100	1.000	1.200	6	8	8	0.05	0.053	0.047	0.021	0.949	0.854	0.379
T4ZB474*035C□L@4^++	B	0.47	35	10	0.100	1.000	1.200	6	8	8	0.07	0.084	0.075	0.033	0.837	0.753	0.335
T4ZD105*035C□L@4^++	D	1	35	6.5	0.175	1.750	2.100	6	8	8	0.08	0.111	0.100	0.044	0.721	0.649	0.288
T4ZF335*035C□L@4^++	F	3.3	35	2.5	0.578	5.775	6.930	6	8	8	0.1	0.200	0.180	0.080	0.500	0.450	0.200

All technical data relates to an ambient temperature of +25°C. Capacitance and DF are measured at 120Hz, 0.5V RMS with a maximum DC bias of 2.2 volts. DCL is measured at rated voltage after 5 minutes.

NOTE: KYOCERA AVX reserves the right to supply a higher voltage rating or tighter tolerance part in the same case size, to the same reliability standards.

TAZ SERIES

T4Z HRC4000 Medical Grade for Non-Critical Applications



RATING & PART NUMBER REFERENCE		Parametric Specifications by Rating									Typical RMS Ripple Data by Rating						
		Cap @ 120Hz	DC Rated Voltage	ESR @ 100kHz	DCL max			DF Max			Power Dissipation	25°C Ripple Current	85°C Ripple Current	125°C Ripple Current	25°C Ripple Voltage	85°C Ripple Voltage	125°C Ripple Voltage
					+25°C	+85°C	+125°C	+25°C	+(85/125)°C	-55°C							
P/N	Case	µF @ 25°C	V @ +85°C	Ohms @ +25°C	(µA)	(µA)	(µA)	(%)	(%)	(%)	W	A (100kHz)	A (100kHz)	A (100kHz)	V (100kHz)	V (100kHz)	V (100kHz)
T4ZH106*035C□L@4 ⁺ ++	H	10	35	0.9	1.750	17.500	21.000	8	10	10	0.15	0.408	0.367	0.163	0.367	0.331	0.147
T4ZA104*050C□L@4 ⁺ ++	A	0.1	50	22	0.100	1.000	1.200	6	8	8	0.05	0.048	0.043	0.019	1.049	0.944	0.420
T4ZA154*050C□L@4 ⁺ ++	A	0.15	50	17	0.100	1.000	1.200	6	8	8	0.05	0.054	0.049	0.022	0.922	0.830	0.369
T4ZE105*050C□L@4 ⁺ ++	E	1	50	6	0.250	2.500	3.000	6	8	8	0.09	0.122	0.110	0.049	0.735	0.661	0.294
T4ZF225*050C□L@4 ⁺ ++	F	2.2	50	2.5	0.550	5.500	6.600	6	8	8	0.1	0.200	0.180	0.080	0.500	0.450	0.200
T4ZG335*050C□L@4 ⁺ ++	G	3.3	50	2	0.825	8.250	9.900	6	8	8	0.125	0.250	0.225	0.100	0.500	0.450	0.200

All technical data relates to an ambient temperature of +25°C. Capacitance and DF are measured at 120Hz, 0.5V RMS with a maximum DC bias of 2.2 volts. DCL is measured at rated voltage after 5 minutes.

NOTICE: The specifications set forth herein are subject to change without notice and are typical and may not apply to all applications. KYOCERA AVX does not warrant or guarantee any aspect of the operation or use of any product except as explicitly set forth in the product specification. Unless specifically agreed to in writing. Seller has not tested or certified its products, services or deliverables for use in high risk applications including medical life support, medical device, direct physical patient contact, water treatment, nuclear facilities, weapon systems, mass and air transportation control, flammable environments, or any other potentially life critical uses. By ordering or using KYOCERA AVX products, the user understands and agrees that KYOCERA AVX makes no assurances that the products, services or deliverables are suitable for any high risk uses.

Under no circumstances does Seller warrant or guarantee suitability for any customer design or manufacturing process. Any statements herein are believed to be true, but are presented without warranty of any kind, explicit or implied. Statements concerning use of KYOCERA AVX products are made without any representation that such use is a non-infringing use or is consistent with any regulation. Users should not assume that any or all safety measures are indicated.

NOTE: KYOCERA AVX reserves the right to supply a higher voltage rating or tighter tolerance part in the same case size, to the same reliability standards.

TCP SERIES - DLA 09009

Low ESR Tantalum Modules



TCP Series tantalum modules represent high packing density for applications utilizing multiple components in a parallel configuration, and are available with testing to DLA 09009.

These modules feature stacked assemblies of CWR29 capacitors which provide ultra low ESR and utilize established reliability capacitors (Weibull Grade voltage conditioning) in accordance with MIL-PRF-55365. They can also be supplied with SRC9000 Space Level components.

The stacked construction of fully molded capacitors is compatible with a wide range of SMT board assembly processes including reflow solder or conductive epoxy.

There are two termination finishes available: hot solder dipped ("C") and gold plated ("B").

The molding compound has been selected to meet the requirements of UL94V-0 and outgassing requirements of ASTM E-595.

For moisture sensitivity levels please refer to the High Reliability Tantalum MSL section located in the back of the High Reliability Tantalum Catalog.

DIMENSIONS: **Note: Additional form factors and ratings are available. Contact plant for details.**

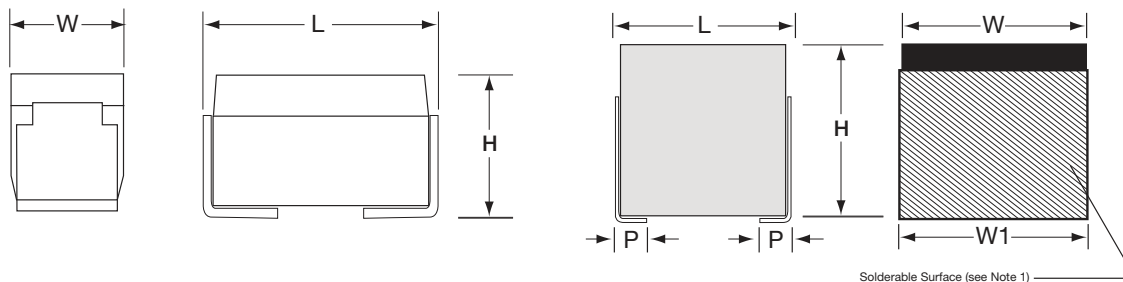

CASE DIMENSIONS:

millimeters (inches)

Case Code	Length (L) ±0.38 (0.015)	Width (W) ±0.38 (0.015)	Height (H) ±0.38 (0.015)	Term. Width (W ₁) ±0.38 (0.015)	Term. Length (P) For Reference Only
2H	7.82 (0.308)	4.06 (0.160)	6.10 (0.240)	4.06 (0.160)	1.52 (0.060)
4H	7.82 (0.308)	8.13 (0.320)	6.10 (0.240)	8.13 (0.320)	1.52 (0.060)
6H	7.82 (0.308)	8.13 (0.320)	9.14 (0.360)	8.13 (0.320)	1.52 (0.060)

Additional form factors and ratings are available – contact plant for details.

CAPACITANCE AND RATED VOLTAGE CASE SIZE (ESR IN mΩ)

Capacitance		Rated voltage DC (V _R) to 85°C						
μF	Code	6V	10V	15V	20V	25V	35V	50V
9.4	945							2H (200)
18.8	196							4H (100)
20	206						2H (200)	
28.2	286							6H (67)
40	406						4H (100)	
60	606						6H (67)	
66	666					2H (85)		
94	946				2H (75)			
132	137					4H (43)		
188	197				4H (38)			
198	207					6H (28)		
200	207			2H (63)				
282	287				6H (25)			
400	407			4H (31)				
440	447		2H (50)					
600	607			6H (21)				
660	667	2H (50)						
880	887		4H (25)					
1,320	138	4H (25)	6H (17)					
1,980	208	6H (17)						

TCP SERIES - DLA 09009

Low ESR Tantalum Modules

HOW TO ORDER

TC Type	2H Case Size	945 Capacitance Code pF code: 1st two digits represent significant figures 3rd digit represents multiplier (number of zeros to follow)	* Capacitance Tolerance M = ±20% K = ±10% J = ±5%	050 Voltage Code 006 = 6Vdc 010 = 10Vdc 015 = 15Vdc 020 = 20Vdc 025 = 25Vdc 035 = 35Vdc 050 = 50Vdc	L ESR L = Low ESR	□ Packaging B = Bulk S = 13" T&R	# Inspection Level S = Std. Conformance L = Group A D = DLA DWG	@ Reliability Grade Weibull: B = 0.1%/1000 hrs. 90% conf. C = 0.01%/1000 hrs. 90% conf. D = 0.001%/1000 hrs. 90% conf. Z = Non-ER	0 Qualification Level 0 = N/A 9 = SRC9000	^ Termination Finish 8 = Hot Solder Dipped 9 = Gold Plated For RoHS compliant products, please select correct termination style.	++ Surge Test Option 00 = None 23 = 10 Cycles, +25°C, -55°C & +85°C 24 = 10 Cycles, -55°C & +85°C 45 = 10 Cycles, -55°C & +85°C before Weibull
-------------------	------------------------	---	--	--	--------------------------------	--	--	--	---	---	--

DLA DWG P/N:

09009 DLA DWG 09009	-01 Dash Number See Rating Tables	* Capacitance Tolerance K = ±10% M = ±20%	@ Reliability Grade B = B Weibull C = C Weibull D = D Weibull	^ Termination Finish B = Gold Plated (10 microinch minimum) C = Hot Solder Dip (60 microinch minimum) For RoHS compliant products, please select correct termination style.	+ Surge Test Option A = 10 cycles, +25°C, -55°C & +85°C B = 10 cycles, -55°C & +85°C before Weibull C = 10 cycles, -55°C & +85°C before Weibull Z = None required Per MIL-PRF-55365
----------------------------------	--	---	--	--	---

SPACE LEVEL SRC9000 P/N*:

TC Type	2H Case Size	945 Capacitance Code pF code: 1st two digits represent significant figures 3rd digit represents multiplier (number of zeros to follow)	* Capacitance Tolerance K = ±10% M = ±20%	050 Voltage Code 006 = 6Vdc 010 = 10Vdc 015 = 15Vdc 020 = 20Vdc 025 = 25Vdc 035 = 35Vdc 050 = 50Vdc	L ESR L = Low ESR	□ Packaging B = Bulk S = 13" T&R	L Inspection Level L = Group A	C Reliability Grade Weibull: C = 0.01%/1000 hrs. 90% conf.	9 Qualification Level 9 = SRC9000	^ Termination Finish 8 = Hot Solder Dipped 9 = Gold Plated For RoHS compliant products, please select correct termination style.	45 Surge Test Option 45 = 10 Cycles, -55°C & +85°C before Weibull
-------------------	------------------------	---	---	--	--------------------------------	--	---	--	--	---	--

*Contact factory for SRC90000 Space Level details

TECHNICAL SPECIFICATIONS

Technical Data:	Unless otherwise specified, all technical data relate to an ambient temperature of 25°C								
Capacitance Range:	9.4 µF to 1,980 µF								
Capacitance Tolerance:	±5%; ±10%; ±20%								
Rated Voltage (V _R)	≤ 85°C:	6	10	15	20	25	35	50	
Category Voltage (V _C)	≤ 125°C:	4	6.7	10	13.3	16.7	23.3	33.3	
Surge Voltage (V _S)	≤ 85°C:	8	13.3	20	26.7	33.3	46.7	66.7	
Surge Voltage (V _S)	≤ 125°C:	5.3	8.7	13.3	17.8	22.2	31.1	44.5	
Temperature Range:	-55°C to +125°C								

TCP SERIES – DLA 09009

Low ESR Tantalum Modules



RATINGS & PART NUMBER REFERENCE

2-STACK				Parametric Specifications by Rating									Typical RMS Ripple Data by Rating					
P/N	DLA P/N	SRC9000 P/N	Case	Cap μ F	Volt V	ESR @ 100 kHz +25°C m Ω	DC Leakage (max) μ A			Dissipation Factor (max) %			100kHz Ripple Current Rating			100kHz Ripple Voltage Rating		
							+25°C	+85°C	+125°C	+25°C	+(85/125)°C	-55°C	A	A	A	V	V	V
							+25°C	+85°C	+125°C	+25°C	+(85/125)°C	-55°C	+25°C	+85°C	+125°C	+25°C	+85°C	+125°C
TC2H667*006L□#@0+++	09009-01*^+^	TC2H667*006L□LC9^45	2H	660	6	50	39.6	396	495	10	12	12	2.45	2.20	0.98	0.12	0.11	0.05
TC2H447*010L□#@0+++	09009-02*^+^	TC2H447*010L□LC9^45	2H	440	10	50	44	440	550	10	12	12	2.45	2.20	0.98	0.12	0.11	0.05
TC2H207*015L□#@0+++	09009-03*^+^	TC2H207*015L□LC9^45	2H	200	15	63	30	300	375	10	12	12	2.19	1.97	0.88	0.14	0.12	0.05
TC2H946*020L□#@0+++	09009-04*^+^	TC2H946*020L□LC9^45	2H	94	20	75	18.8	188	235	8	10	10	2.00	1.80	0.80	0.15	0.14	0.06
TC2H666*025L□#@0+++	09009-05*^+^	TC2H666*025L□LC9^45	2H	66	25	85	16.5	165	206	8	10	10	1.88	1.69	0.75	0.16	0.14	0.06
TC2H206*035L□#@0+++	09009-06*^+^	TC2H206*035L□LC9^45	2H	20	35	200	7	70	88	8	10	10	1.22	1.10	0.49	0.24	0.22	0.10
TC2H945*050L□#@0+++	09009-07*^+^	TC2H945*050L□LC9^45	2H	9.4	50	200	4.7	47	59	6	8	8	1.22	1.10	0.49	0.24	0.22	0.10

4-STACK				Parametric Specifications by Rating									Typical RMS Ripple Data by Rating					
P/N	DLA P/N	SRC9000 P/N	Case	Cap μ F	Volt V	ESR @ 100 kHz +25°C m Ω	DC Leakage (max) μ A			Dissipation Factor (max) %			100kHz Ripple Current Rating			100kHz Ripple Voltage Rating		
							+25°C	+85°C	+125°C	+25°C	+(85/125)°C	-55°C	A	A	A	V	V	V
							+25°C	+85°C	+125°C	+25°C	+(85/125)°C	-55°C	+25°C	+85°C	+125°C	+25°C	+85°C	+125°C
TC4H138*006L□#@0+++	09009-08*^+^	TC4H138*006L□LC9^45	4H	1320	6	25	79.2	792	990	10	12	12	4.90	4.41	1.96	0.12	0.11	0.05
TC4H887*010L□#@0+++	09009-09*^+^	TC4H887*010L□LC9^45	4H	880	10	25	88	880	1100	10	12	12	4.90	4.41	1.96	0.12	0.11	0.05
TC4H407*015L□#@0+++	09009-10*^+^	TC4H407*015L□LC9^45	4H	400	15	31	60	600	750	10	12	12	4.38	3.94	1.75	0.14	0.12	0.05
TC4H197*020L□#@0+++	09009-11*^+^	TC4H197*020L□LC9^45	4H	188	20	38	37.6	376	470	8	10	10	4.00	3.60	1.60	0.15	0.14	0.06
TC4H137*025L□#@0+++	09009-12*^+^	TC4H137*025L□LC9^45	4H	132	25	43	33	330	413	8	10	10	3.74	3.36	1.49	0.16	0.14	0.06
TC4H406*035L□#@0+++	09009-13*^+^	TC4H406*035L□LC9^45	4H	40	35	100	14	140	175	8	10	10	2.45	2.20	0.98	0.24	0.22	0.10
TC4H196*050L□#@0+++	09009-14*^+^	TC4H196*050L□LC9^45	4H	18.8	50	100	9.4	94	118	6	8	8	2.45	2.20	0.98	0.24	0.22	0.10

6-STACK				Parametric Specifications by Rating									Typical RMS Ripple Data by Rating					
P/N	DLA P/N	SRC9000 P/N	Case	Cap μ F	Volt V	ESR @ 100 kHz +25°C m Ω	DC Leakage (max) μ A			Dissipation Factor (max) %			100kHz Ripple Current Rating			100kHz Ripple Voltage Rating		
							+25°C	+85°C	+125°C	+25°C	+(85/125)°C	-55°C	A	A	A	V	V	V
							+25°C	+85°C	+125°C	+25°C	+(85/125)°C	-55°C	+25°C	+85°C	+125°C	+25°C	+85°C	+125°C
TC6H208*006L□#@0+++	09009-15*^+^	TC6H208*006L□LC9^45	6H	1980	6	17	118.8	1188	1485	10	12	12	7.35	6.61	2.94	0.12	0.11	0.05
TC6H138*010L□#@0+++	09009-16*^+^	TC6H138*010L□LC9^45	6H	1320	10	17	132	1320	1650	10	12	12	7.35	6.61	2.94	0.12	0.11	0.05
TC6H607*015L□#@0+++	09009-17*^+^	TC6H607*015L□LC9^45	6H	600	15	21	90	900	1125	10	12	12	6.57	5.92	2.63	0.14	0.12	0.05
TC6H287*020L□#@0+++	09009-18*^+^	TC6H287*020L□LC9^45	6H	282	20	25	56.4	564	705	8	10	10	6.00	5.40	2.40	0.15	0.14	0.06
TC6H207*025L□#@0+++	09009-19*^+^	TC6H207*025L□LC9^45	6H	198	25	28	49.5	495	619	8	10	10	5.67	5.10	2.27	0.16	0.14	0.06
TC6H606*035L□#@0+++	09009-20*^+^	TC6H606*035L□LC9^45	6H	60	35	67	21	210	263	8	10	10	3.67	3.31	1.47	0.24	0.22	0.10
TC6H286*050L□#@0+++	09009-21*^+^	TC6H286*050L□LC9^45	6H	28.2	50	67	14.1	141	176	6	8	8	3.67	3.31	1.47	0.24	0.22	0.10

All technical data relates to an ambient temperature of +25°C. Capacitance and DF are measured at 120Hz, 0.5V RMS with a maximum DC bias of 2.2 volts. DCL is measured at rated voltage after 5 minutes.

NOTE: KYOCERA AVX reserves the right to supply a higher voltage rating or tighter tolerance part in the same case size, to the same reliability standards.

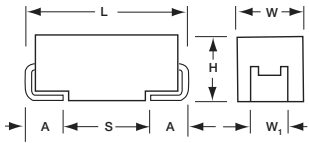

MARKING

(Brown marking on gold body)



Polarity Stripe (+)
"J" for "JAN" Brand
Capacitance Code
Rated Voltage
Manufacturer's ID

GENERAL DESCRIPTION

Fully qualified to MIL-PRF-55365/8, the CWR11 is the military version of EIA-535BAAC, with four case sizes designed for maximum packaging efficiency on 8mm & 12mm tape for high volume production (ensuring no TCE mismatch with any substrate). This construction is compatible with a wide range of SMT board assembly processes including convection reflow solder, conductive epoxy or compression bonding techniques. The part also carries full polarity, capacitance / voltage and JAN brand marking.

The series is qualified to MIL-PRF-55365 Weibull "B", "C", "D" and "T" levels, with all surge options ("A", "B" & "C") available. For Space Level applications, SRC9000 qualification is recommended (see ratings table for part number availability).

There are four termination finishes available: solder plated, fused solder plated, hot solder dipped and gold plated (these are "H", "K", "C" and "B" termination, respectively, per MIL-PRF-55365).

The molding compound has been selected to meet the requirements of UL94V-0 (Flame Retardancy) and outgassing requirements of ASTM E-595.

For moisture sensitivity levels please refer to the High Reliability Tantalum MSL section located in the back of the High Reliability Tantalum Catalog.

CASE DIMENSIONS: millimeters (inches)

Case Code	EIA Metric	Length (L)	Width (W)	Height (H)	Term. Width (W _t) ±0.10 (±0.004)	Term. Length A ±0.30(±0.012)	S min
A	3216-18	3.20±0.20 (0.126±0.008)	1.60±0.20 (0.063±0.008)	1.60±0.20 (0.063±0.008)	1.20 (0.047)	0.80 (0.031)	1.10 (0.043)
B	3528-21	3.50±0.20 (0.138±0.008)	2.80±0.20 (0.110±0.008)	1.90±0.20 (0.075±0.008)	2.20 (0.087)	0.80 (0.031)	1.40 (0.055)
C	6032-28	6.00±0.30 (0.236±0.012)	3.20±0.30 (0.126±0.012)	2.50±0.30 (0.098±0.012)	2.20 (0.087)	1.30 (0.051)	2.90 (0.114)
D	7343-31	7.30±0.30 (0.287±0.012)	4.30±0.30 (0.169±0.012)	2.80±0.30 (0.110±0.012)	2.40 (0.094)	1.30 (0.051)	4.40 (0.173)

CAPACITANCE AND RATED VOLTAGE, V_R (MIL VOLTAGE CODE) RANGE CASE SIZE

Capacitance		Rated Voltage DC (V _R) at 85°C							
µF	Code	4V (C)	6V (D)	10V (F)	15V (H)	20V (J)	25V (K)	35V (M)	50V (N)
0.10	104							A	A
0.15	154							A	B
0.22	224							A	B
0.33	334						A	A	B
0.47	474					A	A	B	C
0.68	684				A	A	B	B	C
1.0	105			A	A	A	B	B	C
1.5	155		A	A	A	B	B	C	D
2.2	225	A	A	A	B	B	C	C	D
3.3	335		A	B	B	B	C	C	D
4.7	475	A	B	B	B	C	C	D	D
6.8	685	B	B	B		C	D	D	
10	106	B	B		C		D		
15	156	B	C	C		D	D		
22	226		C		D	D			
33	336	C		D	D				
47	476		D	D					
68	686	D	D						
100	107	D							

HOW TO ORDER

COTS-PLUS & MIL QPL (CWR11):

TBJ	D	686	*	006	C	□	#	@	0	^	++
Type	Case Size	Capacitance Code pF code: 1st two digits represent significant figures 3rd digit represents multiplier (number of zeros to follow)	Capacitance Tolerance M = ±20% K = ±10% J = ±5%	Voltage Code 004 = 4Vdc 006 = 6Vdc 010 = 10Vdc 015 = 15Vdc 020 = 20Vdc 025 = 25Vdc 035 = 35Vdc 050 = 50Vdc	Standard or Low ESR Range C = Std ESR	Packaging B = Bulk R = 7" T&R S = 13" T&R W = Waffle See page 8 for additional packaging options.	Inspection Level S = Std. Conformance L = Group A M = MIL (JAN) CWR11	Reliability Grade Weibull: B = 0.1%/1000 hrs. 90% conf. C = 0.01%/1000 hrs. 90% conf. D = 0.001%/1000 hrs. 90% conf. Z = Non-ER	Qualification Level 0 = N/A T = T Level 9 = SRC9000	Termination Finish H = Solder Plated 0 = Fused Solder Plated 8 = Hot Solder Dipped 9 = Gold Plated 7 = Matte Sn (COTS-Plus only)	Surge Test Option 00 = None 23 = 10 Cycles, +25°C 24 = 10 Cycles, -55°C & +85°C 45 = 10 cycles, -55°C & +85°C before Weibull

For RoHS compliant products, please select correct termination style.

CWR11 P/N CROSS REFERENCE:

CWR11	D	^	686	*	C	+	□
Type	Voltage Code C = 4Vdc D = 6Vdc F = 10Vdc H = 15Vdc J = 20Vdc K = 25Vdc M = 35Vdc N = 50Vdc	Termination Finish H = Solder Plated K = Solder Fused C = Hot Solder Dipped B = Gold Plated	Capacitance Code pF code: 1st two digits represent significant figures 3rd digit represents multiplier (number of zeros to follow)	Capacitance Tolerance M = ±20% K = ±10% J = ±5%	Reliability Grade Weibull: B = 0.1%/1000 hrs. 90% conf. C = 0.01%/1000 hrs. 90% conf. D = 0.001%/1000 hrs. 90% conf. T = T Level A = Non-ER	Surge Test Option A = 10 cycles, +25°C B = 10 cycles, -55°C & +85°C C = 10 cycles, -55°C & +85°C before Weibull If blank, None required	Packaging Bulk = Standard TR = 7" T&R WR = Waffle See page 8 for additional packaging options.

For RoHS compliant products, please select correct termination style.

SPACE LEVEL OPTIONS TO SRC9000*:

TBJ	D	686	*	006	C	□	L	C	9	^	++
Type	Case Size	Capacitance Code pF code: 1st two digits represent significant figures 3rd digit represents multiplier (number of zeros to follow)	Capacitance Tolerance M = ±20% K = ±10% J = ±5%	Voltage Code 004 = 4Vdc 006 = 6Vdc 010 = 10Vdc 015 = 15Vdc 020 = 20Vdc 025 = 25Vdc 035 = 35Vdc 050 = 50Vdc	Standard or Low ESR Range C = Std ESR	Packaging B = Bulk R = 7" T&R S = 13" T&R W = Waffle See page 8 for additional packaging options.	Inspection Level L = Group A	Reliability Grade Weibull: C = 0.01%/1000 hrs. 90% conf.	Qualification Level 9 = SRC9000	Termination Finish H = Solder Plated 0 = Fused Solder Plated 8 = Hot Solder Dipped 9 = Gold Plated	Surge Test Option 45 = 10 cycles, -55°C & +85°C before Weibull GC = Group C Testing and Data OR = TOR compliant testing and data

For RoHS compliant products, please select correct termination style.

*Contact factory for SRC9000 Space Level SCD details.

TECHNICAL SPECIFICATIONS

Technical Data:	Unless otherwise specified, all technical data relate to an ambient temperature of 25°C									
Capacitance Range:	0.10 µF to 330 µF									
Capacitance Tolerance:	±5%; ±10%; ±20%									
Rated Voltage (V _R)	≤ 85°C:	4	6	10	15	20	25	35	50	
Category Voltage (V _C)	≤125°C:	2.7	4	6.7	10	13.3	16.7	23.3	33.3	
Surge Voltage (V _S)	≤ 85°C:	5.3	8	13.3	20	26.7	33.3	46.7	66.7	
Surge Voltage (V _S)	≤125°C:	3.5	5.3	8.7	13.3	17.8	22.2	31.1	44.5	
Temperature Range:	-55°C to +125°C									



RATING & PART NUMBER REFERENCE				Parametric Specifications by Rating per MIL-PRF-55365/8										Typical RMS Ripple Data by Rating					
				Cap @ 120Hz	DC Rated Voltage	ESR @ 100kHz	DCL max			DF Max			Power Dissipation	25°C Ripple	85°C Ripple	125°C Ripple	25°C Ripple	85°C Ripple	125°C Ripple
							+25°C	+85°C	+125°C	+25°C	+85/125°C	-55°C							
CWR11 P/N	COTS-Plus P/N	SRC9000 P/N	Case	μF @ 25°C	V @ +85°C	Ohms @ +25°C	(μA)	(μA)	(μA)	(%)	(%)	(%)	W	A (100kHz)	A (100kHz)	A (100kHz)	V (100kHz)	V (100kHz)	V (100kHz)
CWR11C225@+H	TBJA 225*004C@# @0^++	TBJA 225*004C@# @0^++	A	2.2	4	8	0.5	5	6	6	9	9	0.075	0.10	0.09	0.04	0.77	0.70	0.31
CWR11C475@+H	TBJA 475*004C@# @0^++	TBJA 475*004C@# @0^++	A	4.7	4	8	0.5	5	6	6	9	9	0.075	0.10	0.09	0.04	0.77	0.70	0.31
CWR11C685@+H	TBJB 685*004C@# @0^++	TBJB 685*004C@# @0^++	B	6.8	4	5.5	0.5	5	6	6	9	9	0.085	0.12	0.11	0.05	0.68	0.62	0.27
CWR11C106@+H	TBJB 106*004C@# @0^++	TBJB 106*004C@# @0^++	B	10	4	4	0.5	5	6	6	9	9	0.085	0.15	0.13	0.06	0.58	0.52	0.23
CWR11C156@+H	TBJB 156*004C@# @0^++	TBJB 156*004C@# @0^++	B	15	4	3.5	0.6	6	7.2	6	9	9	0.085	0.16	0.14	0.06	0.55	0.49	0.22
CWR11C336@+H	TBJC 336*004C@# @0^++	TBJC 336*004C@# @0^++	C	33	4	2.2	1.3	13	15.6	6	9	9	0.110	0.22	0.20	0.09	0.49	0.44	0.20
CWR11D686@+H	TBJD 686*004C@# @0^++	TBJD 686*004C@# @0^++	D	68	4	1.1	2.7	27	32.4	6	9	9	0.150	0.37	0.33	0.15	0.41	0.37	0.16
CWR11C107@+H	TBJD 107*004C@# @0^++	TBJD 107*004C@# @0^++	D	100	4	0.9	4	40	48	8	12	12	0.150	0.41	0.37	0.16	0.37	0.33	0.15
CWR11D155@+H	TBJA 155*006C@# @0^++	TBJA 155*006C@# @0^++	A	1.5	6	8	0.5	5	6	6	9	9	0.075	0.10	0.09	0.04	0.77	0.70	0.31
CWR11D225@+H	TBJA 225*006C@# @0^++	TBJA 225*006C@# @0^++	A	2.2	6	8	0.5	5	6	6	9	9	0.075	0.10	0.09	0.04	0.77	0.70	0.31
CWR11D335@+H	TBJA 335*006C@# @0^++	TBJA 335*006C@# @0^++	A	3.3	6	8	0.5	5	6	6	9	9	0.075	0.10	0.09	0.04	0.77	0.70	0.31
CWR11D475@+H	TBJB 475*006C@# @0^++	TBJB 475*006C@# @0^++	B	4.7	6	5.5	0.5	5	6	6	9	9	0.085	0.12	0.11	0.05	0.68	0.62	0.27
CWR11D685@+H	TBJB 685*006C@# @0^++	TBJB 685*006C@# @0^++	B	6.8	6	4.5	0.5	5	6	6	9	9	0.085	0.14	0.12	0.05	0.62	0.56	0.25
CWR11D106@+H	TBJB 106*006C@# @0^++	TBJB 106*006C@# @0^++	B	10	6	3.5	0.6	6	7.2	6	9	9	0.085	0.16	0.14	0.06	0.55	0.49	0.22
CWR11D156@+H	TBJC 156*006C@# @0^++	TBJC 156*006C@# @0^++	C	15	6	3	0.9	9	10.8	6	9	9	0.110	0.19	0.17	0.08	0.57	0.52	0.23
CWR11D226@+H	TBJC 226*006C@# @0^++	TBJC 226*006C@# @0^++	C	22	6	2.2	1.4	14	16.8	6	9	9	0.110	0.22	0.20	0.09	0.49	0.44	0.20
CWR11D476@+H	TBJD 476*006C@# @0^++	TBJD 476*006C@# @0^++	D	47	6	1.1	2.8	28	33.6	6	9	9	0.150	0.37	0.33	0.15	0.41	0.37	0.16
CWR11D686@+H	TBJD 686*006C@# @0^++	TBJD 686*006C@# @0^++	D	68	6	0.9	4.3	43	51.6	6	9	9	0.150	0.41	0.37	0.16	0.37	0.33	0.15
CWR11F105@+H	TBJA 105*010C@# @0^++	TBJA 105*010C@# @0^++	A	1	10	10	0.5	5	6	4	6	6	0.075	0.09	0.08	0.03	0.87	0.78	0.35
CWR11F155@+H	TBJA 155*010C@# @0^++	TBJA 155*010C@# @0^++	A	1.5	10	8	0.5	5	6	6	9	9	0.075	0.10	0.09	0.04	0.77	0.70	0.31
CWR11F225@+H	TBJA 225*010C@# @0^++	TBJA 225*010C@# @0^++	A	2.2	10	8	0.5	5	6	6	9	9	0.075	0.10	0.09	0.04	0.77	0.70	0.31
CWR11F335@+H	TBJB 335*010C@# @0^++	TBJB 335*010C@# @0^++	B	3.3	10	5.5	0.5	5	6	6	9	9	0.085	0.12	0.11	0.05	0.68	0.62	0.27
CWR11F475@+H	TBJB 475*010C@# @0^++	TBJB 475*010C@# @0^++	B	4.7	10	4.5	0.5	5	6	6	9	9	0.085	0.14	0.12	0.05	0.62	0.56	0.25
CWR11F685@+H	TBJB 685*010C@# @0^++	TBJB 685*010C@# @0^++	B	6.8	10	3.5	0.7	7	8.4	6	9	9	0.085	0.16	0.14	0.06	0.55	0.49	0.22
CWR11J156@+H	TBJC 156*010C@# @0^++	TBJC 156*010C@# @0^++	C	15	10	2.5	1.5	15	18	6	9	9	0.110	0.21	0.19	0.08	0.52	0.47	0.21
CWR11J336@+H	TBJD 336*010C@# @0^++	TBJD 336*010C@# @0^++	D	33	10	1.1	3.3	33	39.6	6	9	9	0.150	0.37	0.33	0.15	0.41	0.37	0.16
CWR11J476@+H	TBJD 476*010C@# @0^++	TBJD 476*010C@# @0^++	D	47	10	0.9	4.7	47	56.4	6	9	9	0.150	0.41	0.37	0.16	0.37	0.33	0.15
CWR11H684@+H	TBJA 684*015C@# @0^++	TBJA 684*015C@# @0^++	A	0.68	15	12	0.5	5	6	4	6	6	0.075	0.08	0.07	0.03	0.95	0.85	0.38
CWR11H105@+H	TBJA 105*015C@# @0^++	TBJA 105*015C@# @0^++	A	1	15	10	0.5	5	6	4	6	6	0.075	0.09	0.08	0.03	0.87	0.78	0.35
CWR11H155@+H	TBJA 155*015C@# @0^++	TBJA 155*015C@# @0^++	A	1.5	15	8	0.5	5	6	4	6	6	0.075	0.10	0.09	0.04	0.77	0.70	0.31
CWR11H225@+H	TBJB 225*015C@# @0^++	TBJB 225*015C@# @0^++	B	2.2	15	5.5	0.5	5	6	6	9	9	0.085	0.12	0.11	0.05	0.68	0.62	0.27
CWR11H335@+H	TBJB 335*015C@# @0^++	TBJB 335*015C@# @0^++	B	3.3	15	5	0.5	5	6	6	8	9	0.085	0.13	0.12	0.05	0.65	0.59	0.26
CWR11H475@+H	TBJB 475*015C@# @0^++	TBJB 475*015C@# @0^++	B	4.7	15	4	0.7	7	8.4	6	9	9	0.085	0.15	0.13	0.06	0.58	0.52	0.23
CWR11H106@+H	TBJC 106*015C@# @0^++	TBJC 106*015C@# @0^++	C	10	15	2.5	1.6	16	19.2	6	8	9	0.110	0.21	0.19	0.08	0.52	0.47	0.21
CWR11H226@+H	TBJD 226*015C@# @0^++	TBJD 226*015C@# @0^++	D	22	15	1.1	3.3	33	39.6	6	8	9	0.150	0.37	0.33	0.15	0.41	0.37	0.16
CWR11H336@+H	TBJD 336*015C@# @0^++	TBJD 336*015C@# @0^++	D	33	15	0.9	5.3	53	63.6	6	9	9	0.150	0.41	0.37	0.16	0.37	0.33	0.15
CWR11J474@+H	TBJA 474*020C@# @0^++	TBJA 474*020C@# @0^++	A	0.47	20	14	0.5	5	6	4	6	6	0.075	0.07	0.07	0.03	1.02	0.92	0.41
CWR11J684@+H	TBJA 684*020C@# @0^++	TBJA 684*020C@# @0^++	A	0.68	20	12	0.5	5	6	4	6	6	0.075	0.08	0.07	0.03	0.95	0.85	0.38
CWR11J105@+H	TBJA 105*020C@# @0^++	TBJA 105*020C@# @0^++	A	1	20	10	0.5	5	6	4	6	6	0.075	0.09	0.08	0.03	0.87	0.78	0.35
CWR11J155@+H	TBJB 155*020C@# @0^++	TBJB 155*020C@# @0^++	B	1.5	20	6	0.5	5	6	4	6	9	0.085	0.12	0.11	0.05	0.71	0.64	0.29
CWR11J225@+H	TBJB 225*020C@# @0^++	TBJB 225*020C@# @0^++	B	2.2	20	5	0.5	5	6	6	8	9	0.085	0.13	0.12	0.05	0.65	0.59	0.26
CWR11J335@+H	TBJB 335*020C@# @0^++	TBJB 335*020C@# @0^++	B	3.3	20	4	0.7	7	8.4	6	9	9	0.085	0.15	0.13	0.06	0.58	0.52	0.23
CWR11J475@+H	TBJC 475*020C@# @0^++	TBJC 475*020C@# @0^++	C	4.7	20	3	1	10	12	6	8	9	0.110	0.19	0.17	0.08	0.57	0.52	0.23
CWR11J685@+H	TBJC 685*020C@# @0^++	TBJC 685*020C@# @0^++	C	6.8	20	2.4	1.4	14	16.8	6	9	9	0.110	0.21	0.19	0.09	0.51	0.46	0.21
CWR11J156@+H	TBJD 156*020C@# @0^++	TBJD 156*020C@# @0^++	D	15	20	1.1	3	30	36	6	8	9	0.150	0.37	0.33	0.15	0.41	0.37	0.16
CWR11J226@+H	TBJD 226*020C@# @0^++	TBJD 226*020C@# @0^++	D	22	20	0.9	4.4	44	52.8	6	9	9	0.150	0.41	0.37	0.16	0.37	0.33	0.15
CWR11K334@+H	TBJA 334*025C@# @0^++	TBJA 334*025C@# @0^++	A	0.33	25	15	0.5	5	6	4	6	6	0.075	0.07	0.06	0.03	1.06	0.95	0.42
CWR11K474@+H	TBJA 474*025C@# @0^++	TBJA 474*025C@# @0^++	A	0.47	25	14	0.5	5	6	4	6	6	0.075	0.07	0.07	0.03	1.02	0.92	0.41
CWR11K684@+H	TBJB 684*025C@# @0^++	TBJB 684*025C@# @0^++	B	0.68	25	7.5	0.5	5	6	4	6	6	0.085	0.11	0.10	0.04	0.80	0.72	0.32
CWR11K105@+H	TBJB 105*025C@# @0^++	TBJB 105*025C@# @0^++	B	1	25	6.5	0.5	5	6	4	6	6	0.085	0.11	0.10	0.05	0.74	0.67	0.30
CWR11K155@+H	TBJB 155*025C@# @0^++	TBJB 155*025C@# @0^++	B	1.5	25	6.5	0.5	5	6	6	8	9	0.085	0.11	0.10	0.05	0.74	0.67	0.30
CWR11K225@+H	TBJC 225*025C@# @0^++	TBJC 225*025C@# @0^++	C	2.2	25	3.5	0.6	6	7.2	6	9	9	0.110	0.18	0.16	0.07	0.62	0.56	0.25
CWR11K335@+H	TBJC 335*025C@# @0^++	TBJC 335*025C@# @0^++	C	3.3	25	3.5	0.9	9	10.8	6	8	9	0.110	0.18	0.16	0.07	0.62	0.56	0.25
CWR11K475@+H	TBJC 475*025C@# @0^++	TBJC 475*025C@# @0^++	C	4.7	25	2.5	1.2	12	14.4	6	5	9	0.110	0.21	0.19	0.08	0.52	0.47	0.21
CWR11K685@+H	TBJD 685*025C@# @0^++	TBJD 685*025C@# @0^++	D	6.8	25	1.4	1.7	17	20.4	6	9	9	0.150	0.33	0.29	0.13	0.46	0.41	0.18
CWR11K106@+H	TBJD 106*025C@# @0^++	TBJD 106*025C@# @0^++	D	10	25	1.2	2.5	25	30	6	8	9	0.150	0.35	0.32	0.14	0.42	0.38	0.17

All technical data relates to an ambient temperature of +25°C. Capacitance and DF are measured at 120Hz, 0.5V RMS with a maximum DC bias of 2.2 volts. DCL is measured at rated voltage after 5 minutes.

NOTE: KYOCERA AVX reserves the right to supply a higher voltage rating or tighter tolerance part in the same case size, to the same reliability standards.

TBJ SERIES

CWR11 - MIL-PRF-55365/8 Established Reliability, COTS-Plus & Space Level



RATING & PART NUMBER REFERENCE				Parametric Specifications by Rating per MIL-PRF-55365/8									Typical RMS Ripple Data by Rating						
				Cap @ 120Hz	DC Rated Voltage	ESR @ 100kHz	DCL max			DF Max			Power Dissipation	25°C Ripple	85°C Ripple	125°C Ripple	25°C Ripple	85°C Ripple	125°C Ripple
							+25°C	+85°C	+125°C	+25°C	+(85/125)°C	-55°C							
CWR11 P/N	COTS-Plus P/N	SRC9000 P/N	Case	µF @ 25°C	V @ +85°C	Ohms @ +25°C	(µA)	(µA)	(µA)	(%)	(%)	(%)	W	A (100kHz)	A (100kHz)	A (100kHz)	V (100kHz)	V (100kHz)	V (100kHz)
CWR11K ¹ 156* ⁺ @ ⁺	TBJD156*025C□#@0 ⁺	TBJD156*025C□LC9 ⁺	D	15	25	1	3.8	38	45.6	6	9	9	0.150	0.39	0.35	0.15	0.39	0.35	0.15
CWR11M ¹ 104* ⁺ @ ⁺	TBJA104*035C□#@0 ⁺	TBJA104*035C□LC9 ⁺	A	0.1	35	24	0.5	5	6	4	6	6	0.075	0.06	0.05	0.02	1.34	1.21	0.54
CWR11M ¹ 154* ⁺ @ ⁺	TBJA154*035C□#@0 ⁺	TBJA154*035C□LC9 ⁺	A	0.15	35	21	0.5	5	6	4	6	6	0.075	0.06	0.05	0.02	1.25	1.13	0.50
CWR11M ¹ 224* ⁺ @ ⁺	TBJA224*035C□#@0 ⁺	TBJA224*035C□LC9 ⁺	A	0.22	35	18	0.5	5	6	4	6	6	0.075	0.06	0.06	0.03	1.16	1.05	0.46
CWR11M ¹ 334* ⁺ @ ⁺	TBJA334*035C□#@0 ⁺	TBJA334*035C□LC9 ⁺	A	0.33	35	15	0.5	5	6	4	6	6	0.075	0.07	0.06	0.03	1.06	0.95	0.42
CWR11M ¹ 474* ⁺ @ ⁺	TBJB474*035C□#@0 ⁺	TBJB474*035C□LC9 ⁺	B	0.47	35	10	0.5	5	6	4	6	6	0.085	0.09	0.08	0.04	0.92	0.83	0.37
CWR11M ¹ 684* ⁺ @ ⁺	TBJB684*035C□#@0 ⁺	TBJB684*035C□LC9 ⁺	B	0.68	35	8	0.5	5	6	4	6	6	0.085	0.10	0.09	0.04	0.82	0.74	0.33
CWR11M ¹ 105* ⁺ @ ⁺	TBJB105*035C□#@0 ⁺	TBJB105*035C□LC9 ⁺	B	1	35	6.5	0.5	5	6	4	6	6	0.085	0.11	0.10	0.05	0.74	0.67	0.30
CWR11M ¹ 155* ⁺ @ ⁺	TBJC155*035C□#@0 ⁺	TBJC155*035C□LC9 ⁺	C	1.5	35	4.5	0.5	5	6	6	8	9	0.110	0.16	0.14	0.06	0.70	0.63	0.28
CWR11M ¹ 225* ⁺ @ ⁺	TBJC225*035C□#@0 ⁺	TBJC225*035C□LC9 ⁺	C	2.2	35	3.5	0.8	8	9.6	6	8	9	0.110	0.18	0.16	0.07	0.62	0.56	0.25
CWR11M ¹ 335* ⁺ @ ⁺	TBJC335*035C□#@0 ⁺	TBJC335*035C□LC9 ⁺	C	3.3	35	2.5	1.2	12	14.4	6	8	9	0.110	0.21	0.19	0.08	0.52	0.47	0.21
CWR11M ¹ 475* ⁺ @ ⁺	TBJD475*035C□#@0 ⁺	TBJD475*035C□LC9 ⁺	D	4.7	35	1.5	1.7	17	20.4	6	8	9	0.150	0.32	0.28	0.13	0.47	0.43	0.19
CWR11M ¹ 685* ⁺ @ ⁺	TBJD685*035C□#@0 ⁺	TBJD685*035C□LC9 ⁺	D	6.8	35	1.3	2.4	24	28.8	6	9	9	0.150	0.34	0.31	0.14	0.44	0.40	0.18
CWR11N ¹ 104* ⁺ @ ⁺	TBJA104*050C□#@0 ⁺	TBJA104*050C□LC9 ⁺	A	0.1	50	22	0.5	5	12	6	8	8	0.075	0.06	0.05	0.02	1.28	1.16	0.51
CWR11N ¹ 154* ⁺ @ ⁺	TBJB154*050C□#@0 ⁺	TBJB154*050C□LC9 ⁺	B	0.15	50	17	0.5	5	6	4	6	6	0.085	0.07	0.06	0.03	1.20	1.08	0.48
CWR11N ¹ 224* ⁺ @ ⁺	TBJB224*050C□#@0 ⁺	TBJB224*050C□LC9 ⁺	B	0.22	50	14	0.5	5	6	4	6	6	0.085	0.08	0.07	0.03	1.09	0.98	0.44
CWR11N ¹ 334* ⁺ @ ⁺	TBJB334*050C□#@0 ⁺	TBJB334*050C□LC9 ⁺	B	0.33	50	12	0.5	5	6	4	6	6	0.085	0.08	0.08	0.03	1.01	0.91	0.40
CWR11N ¹ 474* ⁺ @ ⁺	TBJC474*050C□#@0 ⁺	TBJC474*050C□LC9 ⁺	C	0.47	50	8	0.5	5	6	4	6	6	0.110	0.12	0.11	0.05	0.94	0.84	0.38
CWR11N ¹ 684* ⁺ @ ⁺	TBJC684*050C□#@0 ⁺	TBJC684*050C□LC9 ⁺	C	0.68	50	7	0.5	5	6	4	6	6	0.110	0.13	0.11	0.05	0.88	0.79	0.35
CWR11N ¹ 105* ⁺ @ ⁺	TBJC105*050C□#@0 ⁺	TBJC105*050C□LC9 ⁺	C	1	50	6	0.5	5	6	4	6	6	0.110	0.14	0.12	0.05	0.81	0.73	0.32
CWR11N ¹ 155* ⁺ @ ⁺	TBJD155*050C□#@0 ⁺	TBJD155*050C□LC9 ⁺	D	1.5	50	4	0.8	8	9.6	6	8	9	0.150	0.19	0.17	0.08	0.77	0.70	0.31
CWR11N ¹ 225* ⁺ @ ⁺	TBJD225*050C□#@0 ⁺	TBJD225*050C□LC9 ⁺	D	2.2	50	2.5	1.1	11	13.2	6	8	9	0.150	0.24	0.22	0.10	0.61	0.55	0.24
CWR11N ¹ 335* ⁺ @ ⁺	TBJD335*050C□#@0 ⁺	TBJD335*050C□LC9 ⁺	D	3.3	50	2	1.7	17	20.4	6	9	9	0.150	0.27	0.25	0.11	0.55	0.49	0.22
CWR11N ¹ 475* ⁺ @ ⁺	TBJD475*050C□#@0 ⁺	TBJD475*050C□LC9 ⁺	D	4.7	50	1.5	2.4	24	28.8	6	9	9	0.150	0.32	0.28	0.13	0.47	0.43	0.19

All technical data relates to an ambient temperature of +25°C. Capacitance and DF are measured at 120Hz, 0.5V RMS with a maximum DC bias of 2.2 volts. DCL is measured at rated voltage after 5 minutes.

NOTE: KYOCERA AVX reserves the right to supply a higher voltage rating or tighter tolerance part in the same case size, to the same reliability standards.

TBJ SERIES

COTS-Plus

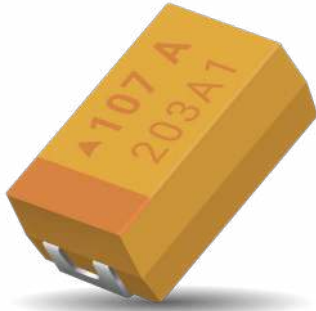

The TBJ COTS-Plus series, based on the CWR11 form factor, is a high reliability series encompassing the current range of EIA Low ESR ratings. These ratings are available with Weibull grading (B and C), surge current testing (A, B, C) per MIL-PRF-55365 Rev. G, and optional Group A from MIL-PRF-55365.

For Space Level applications, SRC9000 qualification is recommended. Please refer to the TBJ COTS-Plus SRC9000 Datasheet for part number availability.

There are five termination finishes available: solder plated, fused solder plated, hot solder dipped, 100% Tin and gold plated (these correspond to "H", "K", "C", "7" and "B" termination, respectively). The molding compound has been selected to meet the requirements of UL94V-0 (Flame Retardancy) and outgassing requirements of ASTM E-595.

For moisture sensitivity levels please refer to the High Reliability Tantalum MSL section located in the back of the High Reliability Tantalum Catalog.

CASE DIMENSIONS: millimeters (inches)

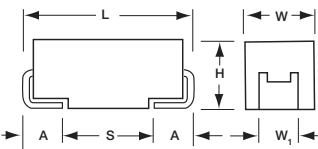

Code	EIA Code	EIA Metric	L±0.20 (0.008)	W+0.20(0.008) -0.10 (0.004)	H+0.20 (0.008) -0.10 (0.004)	W,±0.20 (0.008)	A+0.30(0.012) -0.20(0.008)	S Min.
A	1206	3216-18	3.20 (0.126)	1.60 (0.063)	1.60 (0.063)	1.20 (0.047)	0.80 (0.031)	1.10 (0.043)
B	1210	3528-21	3.50 (0.138)	2.80 (0.110)	1.90 (0.075)	2.20 (0.087)	0.80 (0.031)	1.40 (0.055)
C	2312	6032-28	6.00 (0.236)	3.20 (0.126)	2.60 (0.102)	2.20 (0.087)	1.30 (0.051)	2.90 (0.114)
D	2917	7343-31	7.30 (0.287)	4.30 (0.169)	2.90 (0.114)	2.40 (0.094)	1.30 (0.051)	4.40 (0.173)
E	2917	7343-43	7.30 (0.287)	4.30 (0.169)	4.10 (0.162)	2.40 (0.094)	1.30 (0.051)	4.40 (0.173)
V	2924	7361-38	7.30 (0.287)	6.10 (0.240)	3.55 (0.140)	3.10 (0.122)	1.30 (0.051)	4.40 (0.173)

W₁ dimension applies to the termination width for A dimensional area only.

MARKING

A, B, C, D, E, V CASE

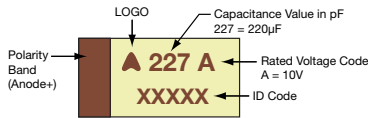

HOW TO ORDER

PART NUMBER:

TBJ	D	227	*	035	C	□	#	@	0	^	#
Type	Case Size	Capacitance Code	Capacitance Tolerance	Voltage Code	ESR	Packaging	Inspection Level	Reliability Grade	Qualification Level	Termination Finish	Surge Test Option
		pF code: 1st two digits represent significant figures 3rd digit represents multiplier (number of zeros to follow)	K = ±10% M = ±20%	002 = 2Vdc 004 = 4Vdc 006 = 6Vdc 010 = 10Vdc 016 = 16Vdc 020 = 20Vdc 025 = 25Vdc 035 = 35Vdc 050 = 50Vdc	C = Std ESR L = Low ESR	B = Bulk R = 7" T&R S = 13" T&R W = Waffle	S = Std. Conformance L = Group A	Weibull: B = 0.1%/1000 hrs. 90% conf. C = 0.01%/1000 hrs. 90% conf. Z = Non-ER	0 = N/A	H = Solder Plated 0 = Fused Solder Plated 8 = Hot Solder Dipped 9 = Gold Plated 7 = Matte Sn	00 = None 23 = 10 Cycles, +25°C 24 = 10 Cycles, -55°C & +85°C 45 = 10 cycles, -55°C & +85°C before Weibull

*For Gold Plated Termination Finish, contact the factory for availability.



TECHNICAL SPECIFICATIONS

Technical Data:	Unless otherwise specified, all technical data relate to an ambient temperature of 25°C									
Capacitance Range:	0.10 µF to 1500 µF									
Capacitance Tolerance:	±10%; ±20%									
Rated Voltage (V _R)	≤ 85°C:	2	4	6	10	16	20	25	35	50
Category Voltage (V _C)	≤125°C:	1.4	2.7	4	7	10	13	17	23	33
Surge Voltage (V _S)	≤ 85°C:	2.6	5.2	8	13	20	26	32	46	65
Surge Voltage (V _S)	≤125°C:	1.7	3.4	5	8	13	16	20	28	40
Temperature Range:	-55°C to +125°C									

CAPACITANCE AND RATED VOLTAGE, VR (VOLTAGE CODE) RANGE (LETTER DENOTES CASE SIZE)

Capacitance		Rated Voltage DC (V _R) at 85°C									
µF	Code	2V (e)	4V (G)	6V (J)	10V (A)	15V (H)	16V (C)	20V (D)	25V (E)	35V (V)	50V (T)
0.10	104									A(24000)	A(22000)
0.15	154									A(21000)	A(9000, 21000) B(17000)
0.22	224									A(6000, 18000)	A(7000, 18000) B(14000)
0.33	334									A(6000, 15000)	B(12000)
0.47	474							A(14000)	A(7000, 14000)	A(6000, 12000) B(4000, 10000)	C(8000)
0.68	684					A(12000)	A(12000)	A(12000)	A(6000, 10000) B(7500)	A(6000, 8000) B(8000)	A(7900) C(7000)
1.0	105				A(10000)	A(10000)	A(10000)	A(3000, 10000)	A(8000) B(6500)	A(3000, 7500) B(2000, 6500)	C(2500, 6000)
1.5	155			A(8000)	A(8000)	A(8000)		A(6500) B(6000)	A(3000, 7500) B(1800, 6500)	A(1500, 4500) B(2500, 5200) C(4500)	C(1500, 5000) D(4000)
2.2	225		A(8000)	A(8000)	A(1800, 8000)	B(5500)	A(1800, 5500) B(5000)	A(3000, 5300) B(5000)	A(7000) B(900, 4500) C(3500)	A(1500, 4500) B(2000, 4200) C(1000, 3500)	D(1200, 2500)
3.3	335			A(8000)	B(5500)	B(5000)	A(3500, 5000) B(4500)	A(2500) B(1300, 4000)	A(1000, 1500) B(750, 3500) C(3500)	B(1000, 3500) C(700, 2500)	D(800, 2000)
4.7	475		A(8000)	B(5500)	A(1400, 5000) B(4500)	B(4000)	A(2000, 4000) B(800, 3100)	A(1800, 4000) B(750, 3000) C(3000)	A(2800) B(1500, 2800) C(2500)	B(700, 3100) C(600, 2200) D(500, 1500)	D(300, 1500)
6.8	685		B(5500)	A(1800, 5000) B(4500)	A(1800, 4000) B(3500)		A(1500, 2500) B(60, 2500)	A(1000) B(600, 2500) C(700, 2400)	B(700, 2800) C(500, 2000) D(1400)	C(350, 1800) D(500, 1300)	D(500, 1000)
10	106		B(4000)	A(1500, 4000) B(3500)	A(1800, 3000) B(2500)	C(2500)	A(1000, 3000) B(500, 2800) C(500, 2500)	B(1000, 2100) C(500, 1900)	C(500, 1800) D(1200)	C(600, 1600) D(300, 1000) E(200, 250)	E(400, 500) V(650)
15	156		B(3500)	A(1500, 3500) B(3500) C(3000)	A(1000, 3200) B(450, 2800) C(2500)		B(800, 2500) C(1800)	B(500, 2000) C(400, 1700) D(1100)	C(220, 300) D(300, 1000)	C(350, 1400) D(300, 900)	D(600) E(250, 600)
22	226			A(500, 3000) B(375, 2500) C(2200)	B(700, 2400) C(300, 1000)	D(1100)	B(600, 2300) C(375, 1600) D(1100)	B(400, 600) C(150, 1600) D(200, 900)	C(275, 1400) D(200, 900)	D(400, 900) E(300, 900)	V(390, 600)
33	336		A(3000) C(2200)	A(600) B(600, 2200)	A(700, 1700) B(250, 1800) C(150, 1600) D(1100)	D(900)	B(350) C(300, 1500) D(200, 900)	C(300, 1500) D(100, 900)	D(100, 900) E(300, 900)	D(300, 900) E(100, 250) V(200)	
47	476		A(500)	A(800) B(250, 350) C(300, 1600) D(1100)	B(250, 350) C(200, 1200) D(100, 900)		C(350, 1500) D(150, 900)	D(100, 200) E(70, 250)	D(250, 900) E(80, 100)	E(200, 250) V(200, 400)	
68	686		D(1100)	B(250, 1800) C(150, 1600) D(900)	B(600) C(80, 1200) D(100, 900)		C(125, 200) D(70, 900)	D(70, 900) E(150, 900)	E(125, 200) V(95)	V(150, 200)	
100	107		A(1400) B(200, 1600)	B(250, 400) C(150, 900) D(900)	B(400) C(200, 1200) D(100, 900) E(125)		D(125, 900) E(100, 900)	D(85, 100) E(100, 150) V(85, 200)	V(100)		
150	157	B(150)	B(250) C(70, 80)	C(50, 90) D(50, 900)	D(150, 900) E(100)		D(150, 900) E(100, 300) V(45, 75)	E(300) V(80)			
220	227	B(150, 200) D(45)	D(40, 900)	C(70, 1200) D(100, 900) E(100)	D(150, 900) E(100, 900)		E(100, 150) V(75, 150)				
330	337		C(100) D(35, 45)	D(45, 50) E(100, 900) V(100)	D(150, 900) E(60, 900) V(60, 100)						
470	477	D(35)	D(45, 100) E(35)	D(45, 60) E(50, 900) V(55, 100)	E(50, 900) V(60, 100)						
680	687	D(35, 50) E(35, 50)	D(45, 60) E(40, 60)	E(45, 60) V(35, 40)							
1000	108	E(30, 40)	E(60) V(25, 35)	V(40, 50)							
1500	158	D(100) E(50) V(30, 40)	E(50, 75) V(50, 75)								

Available Ratings: ESR limits quoted in brackets (mOhms)

Note for designers - for the highlighted ratings, higher voltage options are now available in the same case size and are recommended for new designs.

Notes: Voltage ratings are minimum values. KYOCERA AVX reserves the right to supply higher ratings in the same case size, to the same reliability standards.

TBJ SERIES

COTS-Plus



RATING & PART NUMBER REFERENCE		Parametric Specifications by Rating per MIL-PRF-55365/4									Typical RMS Ripple Data by Rating						
		Cap @ 120Hz @ 25°C	DC Rated Voltage @ +85°C	ESR @ 100kHz @ +25°C	DCL max			DF Max			Power Dissipation W	25°C Ripple Current A (100kHz)	85°C Ripple Current A (100kHz)	125°C Ripple Current A (100kHz)	25°C Ripple Voltage V (100kHz)	85°C Ripple Voltage V (100kHz)	125°C Ripple Voltage V (100kHz)
					+25°C	+85°C	+125°C	+25°C	+(85/125)°C	-55°C							
COTS-Plus P/N	Case	µF @ 25°C	V @ +85°C	Ohms @ +25°C	(µA)	(µA)	(µA)	(%)	(%)	(%)							
TBJB157*002L□#@0***	B	150	2	0.15	3	30	60	10	12	14	0.085	0.753	0.677	0.301	0.113	0.102	0.045
TBJB227*002C□#@0***	B	220	2	0.2	4.4	44	88	16	19	21	0.085	0.652	0.587	0.261	0.130	0.117	0.052
TBJB227*002L□#@0***	B	220	2	0.15	4.4	44	88	16	19	21	0.085	0.753	0.677	0.301	0.113	0.102	0.045
TBJD227*002L□#@0***	D	220	2	0.045	4.4	44	88	8	10	12	0.150	1.826	1.643	0.730	0.082	0.074	0.033
TBJD477*002L□#@0***	D	470	2	0.035	9.4	94	188	8	10	12	0.150	2.070	1.863	0.828	0.072	0.065	0.029
TBJD687*002C□#@0***	D	680	2	0.05	13.6	136	272	16	19	21	0.150	1.732	1.559	0.693	0.087	0.078	0.035
TBJD687*002L□#@0***	D	680	2	0.035	13.6	136	272	16	19	21	0.150	2.070	1.863	0.828	0.072	0.065	0.029
TBJE687*002C□#@0***	E	680	2	0.05	13.6	136	272	10	12	14	0.165	1.817	1.635	0.727	0.091	0.082	0.036
TBJE687*002L□#@0***	E	680	2	0.035	13.6	136	272	10	12	14	0.165	2.171	1.954	0.868	0.076	0.068	0.030
TBJE108*002C□#@0***	E	1000	2	0.04	20	200	400	14	17	20	0.165	2.031	1.828	0.812	0.081	0.073	0.032
TBJE108*002L□#@0***	E	1000	2	0.03	20	200	400	14	17	20	0.165	2.345	2.111	0.938	0.070	0.063	0.028
TBJD158*002L□#@0***	D	1500	2	0.1	30	300	600	60	90	90	0.150	1.225	1.102	0.490	0.122	0.110	0.049
TBJE158*002L□#@0***	E	1500	2	0.05	30	300	600	20	24	28	0.165	1.817	1.635	0.727	0.091	0.082	0.036
TBJV158*002C□#@0***	V	1500	2	0.04	30	300	600	20	24	28	0.250	2.500	2.250	1.000	0.100	0.090	0.040
TBJV158*002L□#@0***	V	1500	2	0.03	30	300	600	20	24	28	0.250	2.887	2.598	1.155	0.087	0.078	0.035
TBJA225*004C□#@0***	A	2.2	4	8	0.088	0.88	1.76	6	9	9	0.075	0.097	0.087	0.039	0.775	0.697	0.310
TBJA475*004C□#@0***	A	4.7	4	8	0.188	1.88	3.76	6	9	9	0.075	0.097	0.087	0.039	0.775	0.697	0.310
TBJB685*004C□#@0***	B	6.8	4	5.5	0.272	2.72	5.44	6	9	9	0.085	0.124	0.112	0.050	0.684	0.615	0.273
TBJB106*004C□#@0***	B	10	4	4	0.4	4	8	6	9	9	0.085	0.146	0.131	0.058	0.583	0.525	0.233
TBJB156*004C□#@0***	B	15	4	3.5	0.6	6	12	6	9	9	0.085	0.156	0.140	0.062	0.545	0.491	0.218
TBJA336*004C□#@0***	A	33	4	3	1.32	13.2	26.4	6	9	9	0.075	0.158	0.142	0.063	0.474	0.427	0.190
TBJC336*004C□#@0***	C	33	4	2.2	1.32	13.2	26.4	6	9	9	0.110	0.224	0.201	0.089	0.492	0.443	0.197
TBJA476*004L□#@0***	A	47	4	0.5	1.88	18.8	37.6	8	10	12	0.075	0.387	0.349	0.155	0.194	0.174	0.077
TBJC686*004C□#@0***	C	68	4	1.6	2.72	27.2	54.4	6	9	10	0.110	0.262	0.236	0.105	0.420	0.378	0.168
TBJD686*004C□#@0***	D	68	4	1.1	2.72	27.2	54.4	6	9	9	0.150	0.369	0.332	0.148	0.406	0.366	0.162
TBJA107*004C□#@0***	A	100	4	1.4	4	40	80	30	36	42	0.075	0.231	0.208	0.093	0.324	0.292	0.130
TBJB107*004C□#@0***	B	100	4	1.6	4	40	80	8	10	12	0.085	0.230	0.207	0.092	0.369	0.332	0.148
TBJB107*004L□#@0***	B	100	4	0.2	4	40	80	8	10	12	0.085	0.652	0.587	0.261	0.130	0.117	0.052
TBJB157*004L□#@0***	B	150	4	0.25	6	60	120	10	12	12	0.085	0.583	0.525	0.233	0.146	0.131	0.058
TBJC157*004C□#@0***	C	150	4	0.08	6	60	120	6	9	10	0.110	1.173	1.055	0.469	0.094	0.084	0.038
TBJC157*004L□#@0***	C	150	4	0.07	6	60	120	6	9	10	0.110	1.254	1.128	0.501	0.088	0.079	0.035
TBJD227*004C□#@0***	D	220	4	0.9	8.8	88	176	8	10	12	0.150	0.408	0.367	0.163	0.367	0.331	0.147
TBJD227*004L□#@0***	D	220	4	0.04	8.8	88	176	8	10	12	0.150	1.936	1.743	0.775	0.077	0.070	0.031
TBJC337*004L□#@0***	C	330	4	0.1	13.2	132	264	8	10	12	0.110	1.049	0.944	0.420	0.105	0.094	0.042
TBJD337*004C□#@0***	D	330	4	0.045	13.2	132	264	8	10	12	0.150	1.826	1.643	0.730	0.082	0.074	0.033
TBJD337*004L□#@0***	D	330	4	0.035	13.2	132	264	8	10	12	0.150	2.070	1.863	0.828	0.072	0.065	0.029
TBJD477*004C□#@0***	D	470	4	0.1	18.8	188	376	12	14	16	0.150	1.225	1.102	0.490	0.122	0.110	0.049
TBJD477*004L□#@0***	D	470	4	0.045	18.8	188	376	12	14	16	0.150	1.826	1.643	0.730	0.082	0.074	0.033
TBJE477*004L□#@0***	E	470	4	0.035	18.8	188	376	12	14	16	0.165	2.171	1.954	0.868	0.076	0.068	0.030
TBJD687*004C□#@0***	D	680	4	0.06	27.2	272	544	14	17	20	0.150	1.581	1.423	0.632	0.095	0.085	0.038
TBJD687*004L□#@0***	D	680	4	0.045	27.2	272	544	14	17	20	0.150	1.826	1.643	0.730	0.082	0.074	0.033
TBJE687*004C□#@0***	E	680	4	0.06	27.2	272	544	10	12	14	0.165	1.658	1.492	0.663	0.099	0.090	0.040
TBJE687*004L□#@0***	E	680	4	0.04	27.2	272	544	10	12	14	0.165	2.031	1.828	0.812	0.081	0.073	0.032
TBJE108*004L□#@0***	E	1000	4	0.06	40	400	800	14	17	20	0.165	1.658	1.492	0.663	0.099	0.090	0.040
TBJV108*004C□#@0***	V	1000	4	0.035	40	400	800	16	19	21	0.250	2.673	2.405	1.069	0.094	0.084	0.037
TBJV108*004L□#@0***	V	1000	4	0.025	40	400	800	16	18	20	0.250	3.162	2.846	1.265	0.079	0.071	0.032
TBJE158*004C□#@0***	E	1500	4	0.075	60	600	1200	30	36	42	0.165	1.483	1.335	0.593	0.111	0.100	0.044
TBJE158*004L□#@0***	E	1500	4	0.05	60	600	1200	30	36	42	0.165	1.817	1.635	0.727	0.091	0.082	0.036
TBJV158*004C□#@0***	V	1500	4	0.075	60	600	1200	30	36	42	0.250	1.826	1.643	0.730	0.137	0.123	0.055
TBJV158*004L□#@0***	V	1500	4	0.05	60	600	1200	30	36	42	0.250	2.236	2.012	0.894	0.112	0.101	0.045

All technical data relates to an ambient temperature of +25°C. Capacitance and DF are measured at 120Hz, 0.5V RMS with a maximum DC bias of 2.2 volts. DCL is measured at rated voltage after 5 minutes.

NOTE: KYOCERA AVX reserves the right to supply a higher voltage rating or tighter tolerance part in the same case size, to the same reliability standards.

TBJ SERIES

COTS-Plus



RATING & PART NUMBER REFERENCE		Parametric Specifications by Rating per MIL-PRF-55365/4									Typical RMS Ripple Data by Rating						
		Cap @ 120Hz µF @ 25°C	DC Rated Voltage V @ +85°C	ESR @ 100kHz Ohms @ +25°C	DCL max			DF Max			Power Dissipation W	25°C Ripple Current A (100kHz)	85°C Ripple Current A (100kHz)	125°C Ripple Current A (100kHz)	25°C Ripple Voltage V (100kHz)	85°C Ripple Voltage V (100kHz)	125°C Ripple Voltage V (100kHz)
					+25°C (µA)	+85°C (µA)	+125°C (µA)	+25°C (%)	+85/125°C (%)	-55°C (%)							
COTS-Plus P/N	Case																
TBJA155*006C□#@0^++	A	1.5	6	8	0.09	0.9	1.08	6	9	9	0.075	0.097	0.087	0.039	0.775	0.697	0.310
TBJA225*006C□#@0^++	A	2.2	6	8	0.132	1.32	1.584	6	9	9	0.075	0.097	0.087	0.039	0.775	0.697	0.310
TBJA335*006C□#@0^++	A	3.3	6	8	0.198	1.98	2.376	6	9	9	0.075	0.097	0.087	0.039	0.775	0.697	0.310
TBJB475*006C□#@0^++	B	4.7	6	5.5	0.282	2.82	3.384	6	9	9	0.085	0.124	0.112	0.050	0.684	0.615	0.273
TBJA685*006C□#@0^++	A	6.8	6	5	0.408	4.08	8.16	6	9	10	0.075	0.122	0.110	0.049	0.612	0.551	0.245
TBJA685*006L□#@0^++	A	6.8	6	1.8	0.408	4.08	8.16	6	9	10	0.075	0.204	0.184	0.082	0.367	0.331	0.147
TBJB685*006C□#@0^++	B	6.8	6	4.5	0.408	4.08	4.896	6	9	9	0.085	0.137	0.124	0.055	0.618	0.557	0.247
TBJA106*006C□#@0^++	A	10	6	4	0.6	6	12	6	9	10	0.075	0.137	0.123	0.055	0.548	0.493	0.219
TBJA106*006L□#@0^++	A	10	6	1.5	0.6	6	12	6	9	10	0.075	0.224	0.201	0.089	0.335	0.302	0.134
TBJB106*006C□#@0^++	B	10	6	3.5	0.6	6	7.2	6	9	9	0.085	0.156	0.140	0.062	0.545	0.491	0.218
TBJA156*006C□#@0^++	A	15	6	3.5	0.9	9	18	6	9	10	0.075	0.146	0.132	0.059	0.512	0.461	0.205
TBJA156*006L□#@0^++	A	15	6	1.5	0.9	9	18	6	9	10	0.075	0.224	0.201	0.089	0.335	0.302	0.134
TBJB156*006C□#@0^++	B	15	6	3.5	0.225	2.25	4.5	6	9	10	0.085	0.156	0.140	0.062	0.545	0.491	0.218
TBJC156*006C□#@0^++	C	15	6	3	0.9	9	10.8	6	6	9	0.110	0.191	0.172	0.077	0.574	0.517	0.230
TBJA226*006C□#@0^++	A	22	6	3	1.32	13.2	26.4	6	6	10	0.075	0.158	0.142	0.063	0.474	0.427	0.190
TBJA226*006L□#@0^++	A	22	6	0.5	1.32	13.2	26.4	6	9	10	0.075	0.387	0.349	0.155	0.194	0.174	0.077
TBJB226*006C□#@0^++	B	22	6	2.5	1.32	13.2	26.4	6	9	10	0.085	0.184	0.166	0.074	0.461	0.415	0.184
TBJB226*006L□#@0^++	B	22	6	0.375	1.32	13.2	26.4	6	9	10	0.085	0.476	0.428	0.190	0.179	0.161	0.071
TBJC226*006C□#@0^++	C	22	6	2.2	1.32	13.2	15.84	6	9	9	0.110	0.224	0.201	0.089	0.492	0.443	0.197
TBJA336*006L□#@0^++	A	33	6	0.6	1.98	19.8	39.6	6	10	12	0.075	0.354	0.318	0.141	0.212	0.191	0.085
TBJB336*006C□#@0^++	B	33	6	2.2	1.98	19.8	39.6	6	9	10	0.085	0.197	0.177	0.079	0.432	0.389	0.173
TBJB336*006L□#@0^++	B	33	6	0.6	1.98	19.8	39.6	6	9	10	0.085	0.376	0.339	0.151	0.226	0.203	0.090
TBJA476*006L□#@0^++	A	47	6	0.8	2.82	28.2	56.4	10	12	14	0.075	0.306	0.276	0.122	0.245	0.220	0.098
TBJB476*006C□#@0^++	B	47	6	0.35	2.82	28.2	56.4	6	9	10	0.085	0.493	0.444	0.197	0.172	0.155	0.069
TBJB476*006L□#@0^++	B	47	6	0.25	2.82	28.2	56.4	6	9	10	0.085	0.583	0.525	0.233	0.146	0.131	0.058
TBJC476*006C□#@0^++	C	47	6	1.6	2.82	28.2	56.4	6	9	10	0.110	0.262	0.236	0.105	0.420	0.378	0.168
TBJC476*006L□#@0^++	C	47	6	0.3	2.82	28.2	56.4	6	9	10	0.110	0.606	0.545	0.242	0.182	0.163	0.073
TBJD476*006C□#@0^++	D	47	6	1.1	2.82	28.2	33.84	6	6	9	0.150	0.369	0.332	0.148	0.406	0.366	0.162
TBJB686*006C□#@0^++	B	68	6	1.8	4.08	40.8	81.6	8	10	12	0.085	0.217	0.196	0.087	0.391	0.352	0.156
TBJB686*006L□#@0^++	B	68	6	0.25	4.08	40.8	81.6	8	9	10	0.085	0.583	0.525	0.233	0.146	0.131	0.058
TBJC686*006C□#@0^++	C	68	6	1.6	4.08	40.8	81.6	6	9	10	0.110	0.262	0.236	0.105	0.420	0.378	0.168
TBJC686*006L□#@0^++	C	68	6	0.15	4.08	40.8	81.6	6	9	10	0.110	0.856	0.771	0.343	0.128	0.116	0.051
TBJD686*006C□#@0^++	D	68	6	0.9	4.08	40.8	48.96	6	9	9	0.150	0.408	0.367	0.163	0.367	0.331	0.147
TBJB107*006C□#@0^++	B	100	6	0.4	6	60	120	10	12	14	0.085	0.461	0.415	0.184	0.184	0.166	0.074
TBJB107*006L□#@0^++	B	100	6	0.25	6	60	120	10	12	14	0.085	0.583	0.525	0.233	0.146	0.131	0.058
TBJC107*006C□#@0^++	C	100	6	0.9	6	60	120	6	9	10	0.110	0.350	0.315	0.140	0.315	0.283	0.126
TBJC107*006L□#@0^++	C	100	6	0.15	6	60	120	6	9	10	0.110	0.856	0.771	0.343	0.128	0.116	0.051
TBJD107*006C□#@0^++	D	100	6	0.9	6	60	120	6	9	10	0.150	0.408	0.367	0.163	0.367	0.331	0.147
TBJC157*006C□#@0^++	C	150	6	0.09	9	90	180	6	9	10	0.110	1.106	0.995	0.442	0.099	0.090	0.040
TBJC157*006L□#@0^++	C	150	6	0.05	9	90	180	6	9	10	0.110	1.483	1.335	0.593	0.074	0.067	0.030
TBJD157*006C□#@0^++	D	150	6	0.9	9	90	180	6	9	10	0.150	0.408	0.367	0.163	0.367	0.331	0.147
TBJD157*006L□#@0^++	D	150	6	0.05	9	90	180	6	9	10	0.150	1.732	1.559	0.693	0.087	0.078	0.035
TBJC227*006C□#@0^++	C	220	6	1.2	13.2	132	264	10	12	14	0.110	0.303	0.272	0.121	0.363	0.327	0.145
TBJC227*006L□#@0^++	C	220	6	0.07	13.2	132	264	8	10	12	0.110	1.254	1.128	0.501	0.088	0.079	0.035
TBJD227*006C□#@0^++	D	220	6	0.9	13.2	132	264	8	10	12	0.150	0.408	0.367	0.163	0.367	0.331	0.147
TBJD227*006L□#@0^++	D	220	6	0.1	13.2	132	264	8	10	12	0.150	1.225	1.102	0.490	0.122	0.110	0.049
TBJE227*006L□#@0^++	E	220	6	0.1	13.2	132	264	8	10	12	0.165	1.285	1.156	0.514	0.128	0.116	0.051
TBJD337*006C□#@0^++	D	330	6	0.05	19.8	198	396	6	10	12	0.150	1.732	1.559	0.693	0.087	0.078	0.035
TBJD337*006L□#@0^++	D	330	6	0.045	19.8	198	396	8	10	12	0.150	1.826	1.643	0.730	0.082	0.074	0.033
TBJE337*006C□#@0^++	E	330	6	0.9	19.8	198	396	8	10	12	0.165	0.428	0.385	0.171	0.385	0.347	0.154
TBJE337*006L□#@0^++	E	330	6	0.1	19.8	198	396	8	10	12	0.165	1.285	1.156	0.514	0.128	0.116	0.051

All technical data relates to an ambient temperature of +25°C. Capacitance and DF are measured at 120Hz, 0.5V RMS with a maximum DC bias of 2.2 volts. DCL is measured at rated voltage after 5 minutes.

NOTE: KYOCERA AVX reserves the right to supply a higher voltage rating or tighter tolerance part in the same case size, to the same reliability standards.



TBJ SERIES

COTS-Plus



RATING & PART NUMBER REFERENCE		Parametric Specifications by Rating per MIL-PRF-55365/4									Typical RMS Ripple Data by Rating						
		Cap @ 120Hz	DC Rated Voltage	ESR @ 100kHz	DCL max			DF Max			Power Dissipation	25°C Ripple Current	85°C Ripple Current	125°C Ripple Current	25°C Ripple Voltage	85°C Ripple Voltage	125°C Ripple Voltage
					+25°C	+85°C	+125°C	+25°C	+(85/125) °C	-55°C							
COTS-Plus P/N	Case	µF @ 25°C	V @ +85°C	Ohms @ +25°C	(µA)	(µA)	(µA)	(%)	(%)	(%)	W	A (100kHz)	A (100kHz)	A (100kHz)	V (100kHz)	V (100kHz)	V (100kHz)
TBJV337*006L□#@0^++	V	330	6	0.1	19.8	198	396	8	10	12	0.250	1.581	1.423	0.632	0.158	0.142	0.063
TBJD477*006C□#@0^++	D	470	6	0.06	28.2	282	564	12	14	16	0.150	1.581	1.423	0.632	0.095	0.085	0.038
TBJD477*006L□#@0^++	D	470	6	0.045	28.2	282	564	12	14	16	0.150	1.826	1.643	0.730	0.082	0.074	0.033
TBJE477*006C□#@0^++	E	470	6	0.9	28.2	282	564	10	12	14	0.165	0.428	0.385	0.171	0.385	0.347	0.154
TBJE477*006L□#@0^++	E	470	6	0.05	28.2	282	564	10	12	14	0.165	1.817	1.635	0.727	0.091	0.082	0.036
TBJV477*006C□#@0^++	V	470	6	0.1	28.2	282	564	10	12	12	0.250	1.581	1.423	0.632	0.158	0.142	0.063
TBJV477*006L□#@0^++	V	470	6	0.055	28.2	282	564	10	12	14	0.250	2.132	1.919	0.853	0.117	0.106	0.047
TBJE687*006C□#@0^++	E	680	6	0.06	40.8	408	816	10	12	14	0.165	1.658	1.492	0.663	0.099	0.090	0.040
TBJE687*006L□#@0^++	E	680	6	0.045	40.8	408	816	10	12	14	0.165	1.915	1.723	0.766	0.086	0.078	0.034
TBJV687*006C□#@0^++	V	680	6	0.04	40.8	408	816	10	12	14	0.250	2.500	2.250	1.000	0.100	0.090	0.040
TBJV687*006L□#@0^++	V	680	6	0.035	40.8	408	816	14	17	20	0.250	2.673	2.405	1.069	0.094	0.084	0.037
TBJV108*006C□#@0^++	V	1000	6	0.05	60	600	1200	16	19	21	0.250	2.236	2.012	0.894	0.112	0.101	0.045
TBJV108*006L□#@0^++	V	1000	6	0.04	60	600	1200	16	19	21	0.250	2.500	2.250	1.000	0.100	0.090	0.040
TBJA105*010C□#@0^++	A	1	10	10	0.1	1	1.2	4	6	6	0.075	0.087	0.078	0.035	0.866	0.779	0.346
TBJA155*010C□#@0^++	A	1.5	10	8	0.15	1.5	1.8	6	6	9	0.075	0.097	0.087	0.039	0.775	0.697	0.310
TBJA225*010C□#@0^++	A	2.2	10	8	0.22	2.2	2.64	6	9	9	0.075	0.097	0.087	0.039	0.775	0.697	0.310
TBJA225*010L□#@0^++	A	2.2	10	1.8	0.22	2.2	4.4	6	9	10	0.075	0.204	0.184	0.082	0.367	0.331	0.147
TBJB335*010C□#@0^++	B	3.3	10	5.5	0.33	3.3	3.96	6	9	9	0.085	0.124	0.112	0.050	0.684	0.615	0.273
TBJA475*010C□#@0^++	A	4.7	10	5	0.47	4.7	9.4	6	9	10	0.075	0.122	0.110	0.049	0.612	0.551	0.245
TBJA475*010L□#@0^++	A	4.7	10	1.4	0.47	4.7	9.4	6	9	10	0.075	0.231	0.208	0.093	0.324	0.292	0.130
TBJB475*010C□#@0^++	B	4.7	10	4.5	0.47	4.7	5.64	6	9	9	0.085	0.137	0.124	0.055	0.618	0.557	0.247
TBJA685*010C□#@0^++	A	6.8	10	4	0.68	6.8	13.6	6	9	10	0.075	0.137	0.123	0.055	0.548	0.493	0.219
TBJA685*010L□#@0^++	A	6.8	10	1.8	0.68	6.8	13.6	6	9	10	0.075	0.204	0.184	0.082	0.367	0.331	0.147
TBJB685*010C□#@0^++	B	6.8	10	3.5	0.68	6.8	8.16	6	9	9	0.085	0.156	0.140	0.062	0.545	0.491	0.218
TBJA106*010C□#@0^++	A	10	10	3	1	10	20	6	9	10	0.075	0.158	0.142	0.063	0.474	0.427	0.190
TBJA106*010L□#@0^++	A	10	10	1.8	1	10	20	6	9	10	0.075	0.204	0.184	0.082	0.367	0.331	0.147
TBJB106*010C□#@0^++	B	10	10	2.5	1	10	20	6	9	10	0.085	0.184	0.166	0.074	0.461	0.415	0.184
TBJA156*010C□#@0^++	A	15	10	3.2	1.5	15	30	6	9	10	0.075	0.153	0.138	0.061	0.490	0.441	0.196
TBJA156*010L□#@0^++	A	15	10	1	1.5	15	30	6	9	10	0.075	0.274	0.246	0.110	0.274	0.246	0.110
TBJB156*010C□#@0^++	B	15	10	2.8	1.5	15	30	6	9	10	0.085	0.174	0.157	0.070	0.488	0.439	0.195
TBJB156*010L□#@0^++	B	15	10	0.45	1.5	15	30	6	9	10	0.085	0.435	0.391	0.174	0.196	0.176	0.078
TBJC156*010C□#@0^++	C	15	10	2.5	1.5	15	18	6	6	9	0.110	0.210	0.189	0.084	0.524	0.472	0.210
TBJB226*010C□#@0^++	B	22	10	2.4	2.2	22	44	6	9	10	0.085	0.188	0.169	0.075	0.452	0.406	0.181
TBJB226*010L□#@0^++	B	22	10	0.7	2.2	22	44	6	9	10	0.085	0.348	0.314	0.139	0.244	0.220	0.098
TBJC226*010C□#@0^++	C	22	10	1	2.2	22	44	6	9	10	0.110	0.332	0.298	0.133	0.332	0.298	0.133
TBJC226*010L□#@0^++	C	22	10	0.3	2.2	22	44	6	9	10	0.110	0.606	0.545	0.242	0.182	0.163	0.073
TBJA336*010C□#@0^++	A	33	10	1.7	3.3	33	66	8	10	12	0.075	0.210	0.189	0.084	0.357	0.321	0.143
TBJA336*010L□#@0^++	A	33	10	0.7	3.3	33	66	8	10	12	0.075	0.327	0.295	0.131	0.229	0.206	0.092
TBJB336*010C□#@0^++	B	33	10	1.8	3.3	33	66	6	9	10	0.085	0.217	0.196	0.087	0.391	0.352	0.156
TBJB336*010L□#@0^++	B	33	10	0.25	3.3	33	66	6	8	10	0.085	0.583	0.525	0.233	0.146	0.131	0.058
TBJC336*010C□#@0^++	C	33	10	1.6	3.3	33	66	6	9	10	0.110	0.262	0.236	0.105	0.420	0.378	0.168
TBJC336*010L□#@0^++	C	33	10	0.15	3.3	33	66	6	9	10	0.110	0.856	0.771	0.343	0.128	0.116	0.051
TBJD336*010C□#@0^++	D	33	10	1.1	3.3	33	39.6	6	9	9	0.150	0.369	0.332	0.148	0.406	0.366	0.162
TBJB476*010C□#@0^++	B	47	10	0.35	4.7	47	94	8	10	12	0.085	0.493	0.444	0.197	0.172	0.155	0.069
TBJB476*010L□#@0^++	B	47	10	0.25	4.7	47	94	8	10	12	0.085	0.583	0.525	0.233	0.146	0.131	0.058
TBJC476*010C□#@0^++	C	47	10	1.2	4.7	47	94	6	9	10	0.110	0.303	0.272	0.121	0.363	0.327	0.145
TBJC476*010L□#@0^++	C	47	10	0.2	4.7	47	94	6	9	10	0.110	0.742	0.667	0.297	0.148	0.133	0.059
TBJD476*010C□#@0^++	D	47	10	0.9	4.7	47	56.4	6	9	9	0.150	0.408	0.367	0.163	0.367	0.331	0.147
TBJD476*010L□#@0^++	D	47	10	0.1	4.7	47	94	6	9	10	0.150	1.225	1.102	0.490	0.122	0.110	0.049
TBJB686*010L□#@0^++	B	68	10	0.6	6.8	68	136	8	10	12	0.085	0.376	0.339	0.151	0.226	0.203	0.090
TBJC686*010C□#@0^++	C	68	10	1.2	6.8	68	136	6	10	12	0.110	0.303	0.272	0.121	0.363	0.327	0.145

All technical data relates to an ambient temperature of +25°C. Capacitance and DF are measured at 120Hz, 0.5V RMS with a maximum DC bias of 2.2 volts. DCL is measured at rated voltage after 5 minutes.

NOTE: KYOCERA AVX reserves the right to supply a higher voltage rating or tighter tolerance part in the same case size, to the same reliability standards.

TBJ SERIES

COTS-Plus



RATING & PART NUMBER REFERENCE		Parametric Specifications by Rating per MIL-PRF-55365/4									Typical RMS Ripple Data by Rating						
		Cap @ 120Hz µF @ 25°C	DC Rated Voltage V @ +85°C	ESR @ 100kHz Ohms @ +25°C	DCL max			DF Max			Power Dissipation W	25°C Ripple Current A (100kHz)	85°C Ripple Current A (100kHz)	125°C Ripple Current A (100kHz)	25°C Ripple Voltage V (100kHz)	85°C Ripple Voltage V (100kHz)	125°C Ripple Voltage V (100kHz)
					+25°C	+85°C	+125°C	+25°C	+ (85/125) °C	-55°C							
COTS-Plus P/N	Case	µF @ 25°C	V @ +85°C	Ohms @ +25°C	(µA)	(µA)	(µA)	(%)	(%)	(%)							
TBJC686*010L□#@0^++	C	68	10	0.08	6.8	68	136	6	10	12	0.110	1.173	1.055	0.469	0.094	0.084	0.038
TBJD686*010C□#@0^++	D	68	10	0.9	6.8	68	136	6	9	10	0.150	0.408	0.367	0.163	0.367	0.331	0.147
TBJD686*010L□#@0^++	D	68	10	0.1	6.8	68	136	6	9	10	0.150	1.225	1.102	0.490	0.122	0.110	0.049
TBJB107*010L□#@0^++	B	100	10	0.4	10	100	200	8	10	12	0.085	0.461	0.415	0.184	0.184	0.166	0.074
TBJC107*010C□#@0^++	C	100	10	1.2	10	100	200	8	10	12	0.110	0.303	0.272	0.121	0.363	0.327	0.145
TBJC107*010L□#@0^++	C	100	10	0.2	10	100	200	8	10	12	0.110	0.742	0.667	0.297	0.148	0.133	0.059
TBJD107*010C□#@0^++	D	100	10	0.9	10	100	200	6	9	10	0.150	0.408	0.367	0.163	0.367	0.331	0.147
TBJD107*010L□#@0^++	D	100	10	0.1	10	100	200	6	9	10	0.150	1.225	1.102	0.490	0.122	0.110	0.049
TBJE107*010C□#@0^++	E	100	10	0.125	10	100	200	6	9	10	0.165	1.285	1.156	0.514	0.128	0.116	0.051
TBJD157*010C□#@0^++	D	150	10	0.9	15	150	300	8	10	12	0.150	0.408	0.367	0.163	0.367	0.331	0.147
TBJD157*010L□#@0^++	D	150	10	0.1	15	150	300	8	10	12	0.150	1.225	1.102	0.490	0.122	0.110	0.049
TBJE157*010C□#@0^++	E	150	10	0.1	15	150	300	8	10	12	0.165	1.285	1.156	0.514	0.128	0.116	0.051
TBJD227*010C□#@0^++	D	220	10	0.9	22	220	440	8	10	12	0.150	0.408	0.367	0.163	0.367	0.331	0.147
TBJD227*010L□#@0^++	D	220	10	0.15	22	220	440	8	10	12	0.150	1.000	0.900	0.400	0.150	0.135	0.060
TBJE227*010C□#@0^++	E	220	10	0.9	22	220	440	8	10	12	0.165	0.428	0.385	0.171	0.385	0.347	0.154
TBJE227*010L□#@0^++	E	220	10	0.1	22	220	440	8	10	12	0.165	1.285	1.156	0.514	0.128	0.116	0.051
TBJD337*010C□#@0^++	D	330	10	0.9	33	330	660	8	10	12	0.150	0.408	0.367	0.163	0.367	0.331	0.147
TBJD337*010L□#@0^++	D	330	10	0.15	33	330	660	8	10	12	0.150	1.000	0.900	0.400	0.150	0.135	0.060
TBJE337*010C□#@0^++	E	330	10	0.9	33	330	660	8	10	12	0.165	0.428	0.385	0.171	0.385	0.347	0.154
TBJE337*010L□#@0^++	E	330	10	0.06	33	330	660	8	10	12	0.165	1.658	1.492	0.663	0.099	0.090	0.040
TBJV337*010C□#@0^++	V	330	10	0.1	33	330	660	8	10	12	0.250	1.581	1.423	0.632	0.158	0.142	0.063
TBJV337*010L□#@0^++	V	330	10	0.06	33	330	660	10	10	12	0.250	2.041	1.837	0.816	0.122	0.110	0.049
TBJE477*010C□#@0^++	E	470	10	0.9	47	470	940	10	12	14	0.165	0.428	0.385	0.171	0.385	0.347	0.154
TBJE477*010L□#@0^++	E	470	10	0.05	47	470	940	10	12	14	0.165	1.817	1.635	0.727	0.091	0.082	0.036
TBJV477*010C□#@0^++	V	470	10	0.1	47	470	940	10	12	14	0.250	1.581	1.423	0.632	0.158	0.142	0.063
TBJV477*010L□#@0^++	V	470	10	0.06	47	470	940	10	12	14	0.250	2.041	1.837	0.816	0.122	0.110	0.049
TBJA684*015C□#@0^++	A	0.68	15	12	0.102	1.02	1.224	4	6	6	0.075	0.079	0.071	0.032	0.949	0.854	0.379
TBJA105*015C□#@0^++	A	1	15	10	0.15	1.5	1.8	4	6	6	0.075	0.087	0.078	0.035	0.866	0.779	0.346
TBJA155*015C□#@0^++	A	1.5	15	8	0.225	2.25	2.7	6	9	9	0.075	0.097	0.087	0.039	0.775	0.697	0.310
TBJB225*015C□#@0^++	B	2.2	15	5.5	0.33	3.3	3.96	6	9	9	0.085	0.124	0.112	0.050	0.684	0.615	0.273
TBJB335*015C□#@0^++	B	3.3	15	5	0.495	4.95	5.94	6	8	9	0.085	0.130	0.117	0.052	0.652	0.587	0.261
TBJB475*015C□#@0^++	B	4.7	15	4	0.705	7.05	8.46	6	8	8	0.085	0.146	0.131	0.058	0.583	0.525	0.233
TBJC106*015C□#@0^++	C	10	15	2.5	1.5	15	18	6	8	9	0.110	0.210	0.189	0.084	0.524	0.472	0.210
TBJD226*015C□#@0^++	D	22	15	1.1	3.3	33	39.6	6	8	9	0.150	0.369	0.332	0.148	0.406	0.366	0.162
TBJD336*015C□#@0^++	D	33	15	0.9	4.95	49.5	59.4	6	8	10	0.150	0.408	0.367	0.163	0.367	0.331	0.147
TBJD157*015L□#@0^++	D	150	15	0.05	5.625	56.25	112.5	6	9	10	0.150	1.732	1.559	0.693	0.087	0.078	0.035
TBJA684*016C□#@0^++	A	0.68	16	12	0.109	1.088	2.176	4	6	6	0.075	0.079	0.071	0.032	0.949	0.854	0.379
TBJA105*016C□#@0^++	A	1	16	10	0.16	1.6	3.2	4	6	6	0.075	0.087	0.078	0.035	0.866	0.779	0.346
TBJA225*016C□#@0^++	A	2.2	16	5.5	0.352	3.52	7.04	6	9	10	0.075	0.117	0.105	0.047	0.642	0.578	0.257
TBJA225*016L□#@0^++	A	2.2	16	1.8	0.352	3.52	7.04	6	9	10	0.075	0.204	0.184	0.082	0.367	0.331	0.147
TBJB225*016C□#@0^++	B	2.2	16	5	0.352	3.52	7.04	6	8	8	0.085	0.130	0.117	0.052	0.652	0.587	0.261
TBJA335*016C□#@0^++	A	3.3	16	5	0.528	5.28	10.56	6	9	10	0.075	0.122	0.110	0.049	0.612	0.551	0.245
TBJA335*016L□#@0^++	A	3.3	16	3.5	0.528	5.28	10.56	6	9	10	0.075	0.146	0.132	0.059	0.512	0.461	0.205
TBJB335*016C□#@0^++	B	3.3	16	4.5	0.528	5.28	10.56	6	9	10	0.085	0.137	0.124	0.055	0.618	0.557	0.247
TBJA475*016C□#@0^++	A	4.7	16	4	0.752	7.52	15.04	6	9	10	0.075	0.137	0.123	0.055	0.548	0.493	0.219
TBJA475*016L□#@0^++	A	4.7	16	2	0.752	7.52	15.04	6	9	10	0.075	0.194	0.174	0.077	0.387	0.349	0.155
TBJB475*016C□#@0^++	B	4.7	16	3.1	0.752	7.52	15.04	6	8	8	0.085	0.166	0.149	0.066	0.513	0.462	0.205
TBJB475*016L□#@0^++	B	4.7	16	0.8	0.752	7.52	15.04	6	9	10	0.085	0.326	0.293	0.130	0.261	0.235	0.104
TBJA685*016C□#@0^++	A	6.8	16	2.5	1.088	10.88	21.76	6	9	10	0.075	0.173	0.156	0.069	0.433	0.390	0.173
TBJA685*016L□#@0^++	A	6.8	16	1.5	1.088	10.88	21.76	6	9	10	0.075	0.224	0.201	0.089	0.335	0.302	0.134
TBJB685*016C□#@0^++	B	6.8	16	2.5	1.088	10.88	21.76	6	9	10	0.085	0.184	0.166	0.074	0.461	0.415	0.184

All technical data relates to an ambient temperature of +25°C. Capacitance and DF are measured at 120Hz, 0.5V RMS with a maximum DC bias of 2.2 volts. DCL is measured at rated voltage after 5 minutes.

NOTE: KYOCERA AVX reserves the right to supply a higher voltage rating or tighter tolerance part in the same case size, to the same reliability standards.

TBJ SERIES

COTS-Plus



RATING & PART NUMBER REFERENCE		Parametric Specifications by Rating per MIL-PRF-55365/4									Typical RMS Ripple Data by Rating						
		Cap @ 120Hz	DC Rated Voltage	ESR @ 100kHz	DCL max			DF Max			Power Dissipation	25°C Ripple Current	85°C Ripple Current	125°C Ripple Current	25°C Ripple Voltage	85°C Ripple Voltage	125°C Ripple Voltage
					+25°C	+85°C	+125°C	+25°C	+(85/125)°C	-55°C							
COTS-Plus P/N	Case	µF @ 25°C	V @ +85°C	Ohms @ +25°C	(µA)	(µA)	(µA)	(%)	(%)	(%)	W	A (100kHz)	A (100kHz)	A (100kHz)	V (100kHz)	V (100kHz)	V (100kHz)
TBJB685*016L□#@0***	B	6.8	16	0.6	1.088	10.88	21.76	6	9	10	0.085	0.376	0.339	0.151	0.226	0.203	0.090
TBJA106*016C□#@0***	A	10	16	3	1.6	16	32	8	10	12	0.075	0.158	0.142	0.063	0.474	0.427	0.190
TBJA106*016L□#@0***	A	10	16	1	1.6	16	32	8	10	12	0.075	0.274	0.246	0.110	0.274	0.246	0.110
TBJB106*016C□#@0***	B	10	16	2.8	1.6	16	32	6	9	10	0.085	0.174	0.157	0.070	0.488	0.439	0.195
TBJB106*016L□#@0***	B	10	16	0.5	1.6	16	32	6	9	10	0.085	0.412	0.371	0.165	0.206	0.186	0.082
TBJC106*016C□#@0***	C	10	16	2.5	1.6	16	32	6	8	10	0.110	0.210	0.189	0.084	0.524	0.472	0.210
TBJC106*016L□#@0***	C	10	16	0.5	1.6	16	32	6	9	10	0.110	0.469	0.422	0.188	0.235	0.211	0.094
TBJB156*016C□#@0***	B	15	16	2.5	2.4	24	48	6	9	10	0.085	0.184	0.166	0.074	0.461	0.415	0.184
TBJB156*016L□#@0***	B	15	16	0.8	2.4	24	48	6	9	10	0.085	0.326	0.293	0.130	0.261	0.235	0.104
TBJC156*016C□#@0***	C	15	16	1.8	2.4	24	48	6	9	10	0.110	0.247	0.222	0.099	0.445	0.400	0.178
TBJB226*016C□#@0***	B	22	16	2.3	3.52	35.2	70.4	6	9	10	0.085	0.192	0.173	0.077	0.442	0.398	0.177
TBJB226*016L□#@0***	B	22	16	0.6	3.52	35.2	70.4	6	9	10	0.085	0.376	0.339	0.151	0.226	0.203	0.090
TBJC226*016C□#@0***	C	22	16	1.6	3.52	35.2	70.4	6	9	10	0.110	0.262	0.236	0.105	0.420	0.378	0.168
TBJC226*016L□#@0***	C	22	16	0.375	3.52	35.2	70.4	6	9	10	0.110	0.542	0.487	0.217	0.203	0.183	0.081
TBJD226*016C□#@0***	D	22	16	1.1	3.52	35.2	70.4	6	8	9	0.150	0.369	0.332	0.148	0.406	0.366	0.162
TBJB336*016L□#@0***	B	33	16	0.35	5.28	52.8	105.6	8	10	12	0.085	0.493	0.444	0.197	0.172	0.155	0.069
TBJC336*016C□#@0***	C	33	16	1.5	5.28	52.8	105.6	6	9	10	0.110	0.271	0.244	0.108	0.406	0.366	0.162
TBJC336*016L□#@0***	C	33	16	0.3	5.28	52.8	105.6	6	9	10	0.110	0.606	0.545	0.242	0.182	0.163	0.073
TBJD336*016C□#@0***	D	33	16	0.9	5.28	52.8	105.6	6	9	10	0.150	0.408	0.367	0.163	0.367	0.331	0.147
TBJD336*016L□#@0***	D	33	16	0.2	5.28	52.8	105.6	6	9	10	0.150	0.866	0.779	0.346	0.173	0.156	0.069
TBJC476*016C□#@0***	C	47	16	1.5	7.52	75.2	150.4	6	9	10	0.110	0.271	0.244	0.108	0.406	0.366	0.162
TBJC476*016L□#@0***	C	47	16	0.35	7.52	75.2	150.4	6	9	10	0.110	0.561	0.505	0.224	0.196	0.177	0.078
TBJD476*016C□#@0***	D	47	16	0.9	7.52	75.2	150.4	6	9	10	0.150	0.408	0.367	0.163	0.367	0.331	0.147
TBJD476*016L□#@0***	D	47	16	0.15	7.52	75.2	150.4	6	9	10	0.150	1.000	0.900	0.400	0.150	0.135	0.060
TBJC686*016C□#@0***	C	68	16	0.2	10.88	108.8	217.6	6	9	10	0.110	0.742	0.667	0.297	0.148	0.133	0.059
TBJC686*016L□#@0***	C	68	16	0.125	10.88	108.8	217.6	6	9	10	0.110	0.938	0.844	0.375	0.117	0.106	0.047
TBJD686*016C□#@0***	D	68	16	0.9	10.88	108.8	217.6	6	9	10	0.150	0.408	0.367	0.163	0.367	0.331	0.147
TBJD686*016L□#@0***	D	68	16	0.07	10.88	108.8	217.6	6	9	10	0.150	1.464	1.317	0.586	0.102	0.092	0.041
TBJD107*016C□#@0***	D	100	16	0.9	16	160	320	6	9	10	0.150	0.408	0.367	0.163	0.367	0.331	0.147
TBJD107*016L□#@0***	D	100	16	0.125	16	160	320	6	9	10	0.150	0.986	0.986	0.438	0.137	0.123	0.055
TBJE107*016C□#@0***	E	100	16	0.9	16	160	320	6	9	10	0.165	0.428	0.385	0.171	0.385	0.347	0.154
TBJE107*016L□#@0***	E	100	16	0.1	16	160	320	6	9	10	0.165	1.285	1.156	0.514	0.128	0.116	0.051
TBJD157*016C□#@0***	D	150	16	0.9	24	240	480	6	9	10	0.150	0.408	0.367	0.163	0.367	0.331	0.147
TBJD157*016L□#@0***	D	150	16	0.15	24	240	480	6	9	10	0.150	1.000	0.900	0.400	0.150	0.135	0.060
TBJE157*016C□#@0***	E	150	16	0.3	24	240	480	6	9	10	0.165	0.742	0.667	0.297	0.222	0.200	0.089
TBJE157*016L□#@0***	E	150	16	0.1	24	240	480	6	9	10	0.165	1.285	1.156	0.514	0.128	0.116	0.051
TBJV157*016C□#@0***	V	150	16	0.075	24	240	480	8	10	12	0.250	1.826	1.643	0.730	0.137	0.123	0.055
TBJV157*016L□#@0***	V	150	16	0.045	24	240	480	8	10	12	0.250	2.357	2.121	0.943	0.106	0.095	0.042
TBJE227*016C□#@0***	E	220	16	0.15	35.2	352	704	10	12	14	0.165	1.049	0.944	0.420	0.157	0.142	0.063
TBJE227*016L□#@0***	E	220	16	0.1	35.2	352	704	10	12	14	0.165	1.285	1.156	0.514	0.128	0.116	0.051
TBJV227*016C□#@0***	V	220	16	0.15	35.2	352	704	8	10	12	0.250	1.291	1.162	0.516	0.194	0.174	0.077
TBJV227*016L□#@0***	V	220	16	0.075	35.2	352	704	8	10	12	0.250	1.826	1.643	0.730	0.137	0.123	0.055
TBJA474*020C□#@0***	A	0.47	20	14	0.5	5	10	4	6	6	0.075	0.073	0.066	0.029	1.025	0.922	0.410
TBJA684*020C□#@0***	A	0.68	20	12	0.136	1.36	1.632	4	6	6	0.075	0.079	0.071	0.032	0.949	0.854	0.379
TBJA105*020C□#@0***	A	1	20	10	0.2	2	2.4	4	6	6	0.075	0.087	0.078	0.035	0.866	0.779	0.346
TBJA105*020L□#@0***	A	1	20	3	0.2	2	4	4	6	6	0.075	0.158	0.142	0.063	0.474	0.427	0.190
TBJA155*020C□#@0***	A	1.5	20	6.5	0.3	3	6	4	8	10	0.075	0.107	0.097	0.043	0.698	0.628	0.279
TBJB155*020C□#@0***	B	1.5	20	6	0.3	3	3.6	6	9	9	0.085	0.119	0.107	0.048	0.714	0.643	0.286
TBJA225*020C□#@0***	A	2.2	20	5.3	0.44	4.4	8.8	6	8	8	0.075	0.119	0.107	0.048	0.630	0.567	0.252
TBJA225*020L□#@0***	A	2.2	20	3	0.44	4.4	8.8	6	9	10	0.075	0.158	0.142	0.063	0.474	0.427	0.190
TBJB225*020C□#@0***	B	2.2	20	5	0.44	4.4	5.28	6	8	9	0.085	0.130	0.117	0.052	0.652	0.587	0.261

All technical data relates to an ambient temperature of +25°C. Capacitance and DF are measured at 120Hz, 0.5V RMS with a maximum DC bias of 2.2 volts. DCL is measured at rated voltage after 5 minutes.

NOTE: KYOCERA AVX reserves the right to supply a higher voltage rating or tighter tolerance part in the same case size, to the same reliability standards.

TBJ SERIES

COTS-Plus



RATING & PART NUMBER REFERENCE		Parametric Specifications by Rating per MIL-PRF-55365/4									Typical RMS Ripple Data by Rating						
		Cap @ 120Hz µF @ 25°C	DC Rated Voltage V @ +85°C	ESR @ 100kHz Ohms @ +25°C	DCL max			DF Max			Power Dissipation W	25°C Ripple Current A (100kHz)	85°C Ripple Current A (100kHz)	125°C Ripple Current A (100kHz)	25°C Ripple Voltage V (100kHz)	85°C Ripple Voltage V (100kHz)	125°C Ripple Voltage V (100kHz)
					+25°C	+85°C	+125°C	+25°C	+(85/125)°C	-55°C							
COTS-Plus P/N	Case				(µA)	(µA)	(µA)	(%)	(%)	(%)							
TBJA335*020L□#@0^++	A	3.3	20	2.5	0.66	6.6	13.2	6	9	10	0.075	0.173	0.156	0.069	0.433	0.390	0.173
TBJB335*020C□#@0^++	B	3.3	20	4	0.66	6.6	7.92	6	9	9	0.085	0.146	0.131	0.058	0.583	0.525	0.233
TBJB335*020L□#@0^++	A	3.3	20	1.3	0.66	6.6	13.2	6	9	10	0.085	0.256	0.230	0.102	0.332	0.299	0.133
TBJA475*020C□#@0^++	B	4.7	20	4	0.94	9.4	18.8	6	8	10	0.075	0.137	0.123	0.055	0.548	0.493	0.219
TBJA475*020L□#@0^++	A	4.7	20	1.8	0.94	9.4	18.8	6	8	10	0.075	0.204	0.184	0.082	0.367	0.331	0.147
TBJB475*020C□#@0^++	B	4.7	20	3	0.94	9.4	18.8	6	8	10	0.085	0.168	0.151	0.067	0.505	0.454	0.202
TBJB475*020L□#@0^++	B	4.7	20	0.75	0.94	9.4	18.8	6	9	10	0.085	0.337	0.303	0.135	0.252	0.227	0.101
TBJC475*020C□#@0^++	C	4.7	20	3	0.94	9.4	11.28	6	8	9	0.110	0.191	0.172	0.077	0.574	0.517	0.230
TBJA685*020L□#@0^++	A	6.8	20	1	1.36	13.6	27.2	6	9	10	0.075	0.274	0.246	0.110	0.274	0.246	0.110
TBJB685*020C□#@0^++	B	6.8	20	2.5	1.36	13.6	27.2	6	8	10	0.085	0.184	0.166	0.074	0.461	0.415	0.184
TBJB685*020L□#@0^++	B	6.8	20	0.6	1.36	13.6	27.2	6	9	10	0.085	0.376	0.339	0.151	0.226	0.203	0.090
TBJC685*020C□#@0^++	C	6.8	20	2.4	1.36	13.6	16.32	6	9	9	0.110	0.214	0.193	0.086	0.514	0.462	0.206
TBJC685*020L□#@0^++	C	6.8	20	0.7	1.36	13.6	27.2	6	9	10	0.110	0.396	0.357	0.159	0.277	0.250	0.111
TBJB106*020C□#@0^++	B	10	20	2.1	2	20	40	6	8	10	0.085	0.201	0.181	0.080	0.422	0.380	0.169
TBJB106*020L□#@0^++	B	10	20	1	2	20	40	6	8	10	0.085	0.292	0.262	0.117	0.292	0.262	0.117
TBJC106*020C□#@0^++	C	10	20	1.9	2	20	40	6	8	10	0.110	0.241	0.217	0.096	0.457	0.411	0.183
TBJC106*020L□#@0^++	C	10	20	0.5	2	20	40	6	9	10	0.110	0.469	0.422	0.188	0.235	0.211	0.094
TBJB156*020C□#@0^++	B	15	20	2	3	30	60	6	8	10	0.085	0.206	0.186	0.082	0.412	0.371	0.165
TBJB156*020L□#@0^++	B	15	20	0.5	3	30	60	6	9	10	0.085	0.412	0.371	0.165	0.206	0.186	0.082
TBJC156*020C□#@0^++	C	15	20	1.7	3	30	60	6	8	10	0.110	0.254	0.229	0.102	0.432	0.389	0.173
TBJC156*020L□#@0^++	C	15	20	0.4	3	30	60	6	8	10	0.110	0.524	0.472	0.210	0.210	0.189	0.084
TBJD156*020C□#@0^++	D	15	20	1.1	3	30	36	6	8	9	0.150	0.369	0.332	0.148	0.406	0.366	0.162
TBJB226*020C□#@0^++	B	22	20	0.6	4.4	44	88	6	9	10	0.085	0.376	0.339	0.151	0.226	0.203	0.090
TBJB226*020L□#@0^++	B	22	20	0.4	4.4	44	88	6	9	10	0.085	0.461	0.415	0.184	0.184	0.166	0.074
TBJC226*020C□#@0^++	C	22	20	1.6	4.4	44	88	6	8	10	0.110	0.262	0.236	0.105	0.420	0.378	0.168
TBJC226*020L□#@0^++	C	22	20	0.15	4.4	44	88	6	8	10	0.110	0.856	0.771	0.343	0.128	0.116	0.051
TBJD226*020C□#@0^++	D	22	20	0.9	4.4	44	52.8	6	9	9	0.150	0.408	0.367	0.163	0.367	0.331	0.147
TBJD226*020L□#@0^++	D	22	20	0.2	4.4	44	88	6	9	10	0.150	0.866	0.779	0.346	0.173	0.156	0.069
TBJC336*020C□#@0^++	C	33	20	1.5	6.6	66	132	6	8	10	0.110	0.271	0.244	0.108	0.406	0.366	0.162
TBJC336*020L□#@0^++	C	33	20	0.3	6.6	66	132	6	9	10	0.110	0.606	0.545	0.242	0.182	0.163	0.073
TBJD336*020C□#@0^++	D	33	20	0.9	6.6	66	132	6	8	10	0.150	0.408	0.367	0.163	0.367	0.331	0.147
TBJD336*020L□#@0^++	D	33	20	0.1	6.6	66	132	6	8	10	0.150	1.225	1.102	0.490	0.122	0.110	0.049
TBJD476*020C□#@0^++	D	47	20	0.2	9.4	94	188	6	8	10	0.150	0.866	0.779	0.346	0.173	0.156	0.069
TBJD476*020L□#@0^++	D	47	20	0.1	9.4	94	188	6	8	10	0.150	1.225	1.102	0.490	0.122	0.110	0.049
TBJE476*020C□#@0^++	E	47	20	0.25	9.4	94	188	6	8	8	0.165	0.812	0.731	0.325	0.203	0.183	0.081
TBJE476*020L□#@0^++	E	47	20	0.07	9.4	94	188	6	9	10	0.165	1.535	1.382	0.614	0.107	0.097	0.043
TBJD686*020C□#@0^++	D	68	20	0.9	13.6	136	272	6	8	10	0.150	0.408	0.367	0.163	0.367	0.331	0.147
TBJD686*020L□#@0^++	D	68	20	0.07	13.6	136	272	6	9	10	0.150	1.464	1.317	0.586	0.102	0.092	0.041
TBJE686*020C□#@0^++	E	68	20	0.9	13.6	136	272	6	8	10	0.165	0.428	0.385	0.171	0.385	0.347	0.154
TBJE686*020L□#@0^++	E	68	20	0.15	13.6	136	272	6	8	10	0.165	1.049	0.944	0.420	0.157	0.142	0.063
TBJD107*020C□#@0^++	D	100	20	0.1	20	200	400	6	9	10	0.150	1.225	1.102	0.490	0.122	0.110	0.049
TBJD107*020L□#@0^++	D	100	20	0.085	20	200	400	6	9	10	0.150	1.328	1.196	0.531	0.113	0.102	0.045
TBJE107*020C□#@0^++	E	100	20	0.15	20	200	400	6	9	10	0.165	1.049	0.944	0.420	0.157	0.142	0.063
TBJE107*020L□#@0^++	E	100	20	0.1	20	200	400	6	9	10	0.165	1.285	1.156	0.514	0.128	0.116	0.051
TBJV107*020C□#@0^++	V	100	20	0.2	20	200	400	8	10	12	0.250	1.118	1.006	0.447	0.224	0.201	0.089
TBJV107*020L□#@0^++	V	100	20	0.085	20	200	400	8	10	12	0.250	1.715	1.543	0.686	0.146	0.131	0.058
TBJE157*020C□#@0^++	E	150	20	0.3	30	300	600	8	10	10	0.165	0.742	0.667	0.297	0.222	0.200	0.089
TBJV157*020L□#@0^++	V	150	20	0.08	30	300	600	8	10	12	0.250	1.768	1.591	0.707	0.141	0.127	0.057
TBJA334*025C□#@0^++	A	0.33	25	15	0.083	0.825	0.99	4	6	6	0.075	0.071	0.064	0.028	1.061	0.955	0.424
TBJA474*025C□#@0^++	A	0.47	25	14	0.118	1.175	1.41	4	6	6	0.075	0.073	0.066	0.029	1.025	0.922	0.410
TBJA474*025L□#@0^++	A	0.47	25	7	0.118	1.175	2.35	4	6	6	0.075	0.104	0.093	0.041	0.725	0.652	0.290

All technical data relates to an ambient temperature of +25°C. Capacitance and DF are measured at 120Hz, 0.5V RMS with a maximum DC bias of 2.2 volts. DCL is measured at rated voltage after 5 minutes.

NOTE: KYOCERA AVX reserves the right to supply a higher voltage rating or tighter tolerance part in the same case size, to the same reliability standards.



TBJ SERIES

COTS-Plus



RATING & PART NUMBER REFERENCE		Parametric Specifications by Rating per MIL-PRF-55365/4									Typical RMS Ripple Data by Rating						
		Cap @ 120Hz	DC Rated Voltage	ESR @ 100kHz	DCL max			DF Max			Power Dissipation	25°C Ripple Current	85°C Ripple Current	125°C Ripple Current	25°C Ripple Voltage	85°C Ripple Voltage	125°C Ripple Voltage
					+25°C	+85°C	+125°C	+25°C	+(85/125)°C	-55°C							
COTS-Plus P/N	Case	µF @ 25°C	V @ +85°C	Ohms @ +25°C	(µA)	(µA)	(µA)	(%)	(%)	(%)	W	A (100kHz)	A (100kHz)	A (100kHz)	V (100kHz)	V (100kHz)	V (100kHz)
TBJA684*025C□#@0^++	A	0.68	25	10	0.68	6.8	13.6	4	6	8	0.075	0.087	0.078	0.035	0.866	0.779	0.346
TBJA684*025L□#@0^++	A	0.68	25	6	0.17	1.7	3.4	4	6	6	0.075	0.112	0.101	0.045	0.671	0.604	0.268
TBJB684*025C□#@0^++	B	0.68	25	7.5	0.17	1.7	2.04	4	6	6	0.085	0.106	0.096	0.043	0.798	0.719	0.319
TBJA105*025C□#@0^++	A	1	25	8	0.25	2.5	5	4	6	8	0.075	0.097	0.087	0.039	0.775	0.697	0.310
TBJB105*025C□#@0^++	B	1	25	6.5	0.25	2.5	3	4	6	6	0.085	0.114	0.103	0.046	0.743	0.669	0.297
TBJA155*025C□#@0^++	A	1.5	25	7.5	0.375	3.75	7.5	6	8	10	0.075	0.100	0.090	0.040	0.750	0.675	0.300
TBJA155*025L□#@0^++	A	1.5	25	3	0.375	3.75	7.5	6	8	10	0.075	0.158	0.142	0.063	0.474	0.427	0.190
TBJB155*025C□#@0^++	B	1.5	25	6.5	0.375	3.75	4.5	6	8	9	0.085	0.114	0.103	0.046	0.743	0.669	0.297
TBJB155*025L□#@0^++	B	1.5	25	1.8	0.375	3.75	7.5	6	9	10	0.085	0.217	0.196	0.087	0.391	0.352	0.156
TBJA225*025C□#@0^++	A	2.2	25	7.0	0.6	6	12	6	9	10	0.075	0.104	0.093	0.041	0.725	0.652	0.290
TBJB225*025C□#@0^++	B	2.2	25	4.5	0.55	5.5	11	6	8	10	0.085	0.137	0.124	0.055	0.618	0.557	0.247
TBJB225*025L□#@0^++	B	2.2	25	0.9	0.55	5.5	11	6	9	10	0.085	0.307	0.277	0.123	0.277	0.249	0.111
TBJC225*025C□#@0^++	C	2.2	25	3.5	0.55	5.5	6.6	6	9	9	0.110	0.177	0.160	0.071	0.620	0.558	0.248
TBJA335*025C□#@0^++	A	3.3	25	1.5	0.825	8.25	16.5	6	9	10	0.075	0.224	0.201	0.089	0.335	0.302	0.134
TBJA335*025L□#@0^++	A	3.3	25	1	0.825	8.25	16.5	6	9	10	0.075	0.274	0.246	0.110	0.274	0.246	0.110
TBJB335*025C□#@0^++	B	3.3	25	3.5	0.825	8.25	16.5	6	8	10	0.085	0.156	0.140	0.062	0.545	0.491	0.218
TBJB335*025L□#@0^++	B	3.3	25	0.75	0.825	8.25	16.5	6	9	10	0.085	0.337	0.303	0.135	0.252	0.227	0.101
TBJC335*025C□#@0^++	C	3.3	25	3.5	0.825	8.25	9.9	6	8	9	0.110	0.177	0.160	0.071	0.620	0.558	0.248
TBJA475*025C□#@0^++	A	4.7	25	2.8	1.175	11.75	23.5	6	9	10	0.075	0.164	0.147	0.065	0.458	0.412	0.183
TBJB475*025C□#@0^++	B	4.7	25	2.8	1.175	11.75	23.5	6	8	10	0.085	0.174	0.157	0.070	0.488	0.439	0.195
TBJB475*025L□#@0^++	B	4.7	25	1.5	1.175	11.75	23.5	6	8	10	0.085	0.238	0.214	0.095	0.357	0.321	0.143
TBJC475*025C□#@0^++	C	4.7	25	2.5	1.175	11.75	14.1	6	9	9	0.110	0.210	0.189	0.084	0.524	0.472	0.210
TBJB685*025C□#@0^++	B	6.8	25	2.8	1.7	17	34	6	8	10	0.085	0.174	0.157	0.070	0.488	0.439	0.195
TBJB685*025L□#@0^++	B	6.8	25	0.7	1.7	17	34	6	9	10	0.085	0.348	0.314	0.139	0.244	0.220	0.098
TBJC685*025C□#@0^++	C	6.8	25	2	1.7	17	34	6	8	10	0.110	0.235	0.211	0.094	0.469	0.422	0.188
TBJC685*025L□#@0^++	C	6.8	25	0.5	1.7	17	34	6	9	10	0.110	0.469	0.422	0.188	0.235	0.211	0.094
TBJD685*025C□#@0^++	D	6.8	25	1.4	1.7	17	20.4	6	9	9	0.150	0.327	0.295	0.131	0.458	0.412	0.183
TBJC106*025C□#@0^++	C	10	25	1.8	2.5	25	50	6	8	10	0.110	0.247	0.222	0.099	0.445	0.400	0.178
TBJC106*025L□#@0^++	C	10	25	0.5	2.5	25	50	6	8	10	0.110	0.469	0.422	0.188	0.235	0.211	0.094
TBJD106*025C□#@0^++	D	10	25	1.2	2.5	25	30	6	8	9	0.150	0.354	0.318	0.141	0.424	0.382	0.170
TBJC156*025C□#@0^++	C	15	25	0.3	3.75	37.5	75	6	9	10	0.110	0.606	0.545	0.242	0.182	0.163	0.073
TBJC156*025L□#@0^++	C	15	25	0.22	3.75	37.5	75	6	9	10	0.110	0.707	0.636	0.283	0.156	0.140	0.062
TBJD156*025C□#@0^++	D	15	25	1	3.75	37.5	45	6	9	9	0.150	0.387	0.349	0.155	0.387	0.349	0.155
TBJD156*025L□#@0^++	D	15	25	0.3	3.75	37.5	75	6	8	9	0.150	0.707	0.636	0.283	0.212	0.191	0.085
TBJC226*025C□#@0^++	C	22	25	1.4	5.5	55	110	6	8	10	0.110	0.280	0.252	0.112	0.392	0.353	0.157
TBJC226*025L□#@0^++	C	22	25	0.275	5.5	55	110	6	8	10	0.110	0.632	0.569	0.253	0.174	0.157	0.070
TBJD226*025C□#@0^++	D	22	25	0.9	5.5	55	110	6	8	10	0.150	0.408	0.367	0.163	0.367	0.331	0.147
TBJD226*025L□#@0^++	D	22	25	0.2	5.5	55	110	6	8	10	0.150	0.866	0.779	0.346	0.173	0.156	0.069
TBJD336*025C□#@0^++	D	33	25	0.9	8.25	82.5	165	6	8	10	0.150	0.408	0.367	0.163	0.367	0.331	0.147
TBJD336*025L□#@0^++	D	33	25	0.1	8.25	82.5	165	6	8	10	0.150	1.225	1.102	0.490	0.122	0.110	0.049
TBJE336*025C□#@0^++	E	33	25	0.9	8.25	82.5	165	6	8	10	0.165	0.428	0.385	0.171	0.385	0.347	0.154
TBJE336*025L□#@0^++	E	33	25	0.3	8.25	82.5	165	6	8	10	0.165	0.742	0.667	0.297	0.222	0.200	0.089
TBJD476*025C□#@0^++	D	47	25	0.9	11.75	117.5	235	6	8	10	0.150	0.408	0.367	0.163	0.367	0.331	0.147
TBJD476*025L□#@0^++	D	47	25	0.25	11.75	117.5	235	6	8	10	0.150	0.775	0.697	0.310	0.194	0.174	0.077
TBJE476*025C□#@0^++	E	47	25	0.1	11.75	117.5	235	6	9	10	0.165	1.285	1.156	0.514	0.128	0.116	0.051
TBJE476*025L□#@0^++	E	47	25	0.08	11.75	117.5	235	6	9	10	0.165	1.436	1.293	0.574	0.115	0.103	0.046
TBJE686*025C□#@0^++	E	68	25	0.2	17	170	340	6	9	10	0.165	0.908	0.817	0.363	0.182	0.163	0.073
TBJE686*025L□#@0^++	E	68	25	0.125	17	170	340	6	9	10	0.165	1.149	1.034	0.460	0.144	0.129	0.057
TBJV686*025L□#@0^++	V	68	25	0.095	17	170	340	6	9	10	0.250	1.622	1.460	0.649	0.154	0.139	0.062

All technical data relates to an ambient temperature of +25°C. Capacitance and DF are measured at 120Hz, 0.5V RMS with a maximum DC bias of 2.2 volts. DCL is measured at rated voltage after 5 minutes.

NOTE: KYOCERA AVX reserves the right to supply a higher voltage rating or tighter tolerance part in the same case size, to the same reliability standards.



The Important Information/Disclaimer is incorporated in the catalog where these specifications came from or available online at www.kyocera-avx.com/disclaimer/ by reference and should be reviewed in full before placing any order.

TBJ SERIES

COTS-Plus



RATING & PART NUMBER REFERENCE		Parametric Specifications by Rating per MIL-PRF-55365/4									Typical RMS Ripple Data by Rating						
		Cap @ 120Hz @ 25°C	DC Rated Voltage @ +85°C	ESR @ 100kHz @ +25°C	DCL max			DF Max			Power Dissipation W	25°C Ripple Current A (100kHz)	85°C Ripple Current A (100kHz)	125°C Ripple Current A (100kHz)	25°C Ripple Voltage V (100kHz)	85°C Ripple Voltage V (100kHz)	125°C Ripple Voltage V (100kHz)
					+25°C	+85°C	+125°C	+25°C	+(85/125)°C	-55°C							
COTS-Plus P/N	Case	µF	V	Ohms	(µA)	(µA)	(µA)	(%)	(%)	(%)							
TBJV107*025L□#@0^++	V	100	25	0.1	25	250	500	8	10	12	0.250	1.581	1.423	0.632	0.158	0.142	0.063
TBJA104*035C□#@0^++	A	0.1	35	24	0.035	0.35	0.42	4	6	6	0.075	0.056	0.050	0.022	1.342	1.207	0.537
TBJA154*035C□#@0^++	A	0.15	35	21	0.5	5	10	4	6	6	0.075	0.060	0.054	0.024	1.255	1.129	0.502
TBJA224*035C□#@0^++	A	0.22	35	18	0.5	5	10	4	6	6	0.075	0.065	0.058	0.026	1.162	1.046	0.465
TBJA224*035L□#@0^++	A	0.22	35	6	0.077	0.77	1.54	4	6	6	0.075	0.112	0.101	0.045	0.671	0.604	0.268
TBJA334*035C□#@0^++	A	0.33	35	15	0.5	5	10	4	6	6	0.075	0.071	0.064	0.028	1.061	0.955	0.424
TBJA334*035L□#@0^++	A	0.33	35	6	0.116	1.155	2.31	4	6	6	0.075	0.112	0.101	0.045	0.671	0.604	0.268
TBJA474*035C□#@0^++	A	0.47	35	12	0.165	1.645	3.29	4	6	8	0.075	0.079	0.071	0.032	0.949	0.854	0.379
TBJA474*035L□#@0^++	A	0.47	35	6	0.165	1.645	3.29	4	6	6	0.075	0.112	0.101	0.045	0.671	0.604	0.268
TBJB474*035C□#@0^++	B	0.47	35	10	0.165	1.645	1.974	4	6	6	0.085	0.092	0.083	0.037	0.922	0.830	0.369
TBJB474*035L□#@0^++	B	0.47	35	4	0.165	1.645	3.29	4	6	6	0.085	0.146	0.131	0.058	0.583	0.525	0.233
TBJA684*035C□#@0^++	A	0.68	35	8	0.238	2.38	4.76	4	6	8	0.075	0.097	0.087	0.039	0.775	0.697	0.310
TBJA684*035L□#@0^++	A	0.68	35	6	0.238	2.38	4.76	4	6	6	0.075	0.112	0.101	0.045	0.671	0.604	0.268
TBJB684*035C□#@0^++	B	0.68	35	8	0.238	2.38	2.856	4	6	6	0.085	0.103	0.093	0.041	0.825	0.742	0.330
TBJA105*035C□#@0^++	A	1	35	7.5	0.35	3.5	7	4	6	6	0.075	0.100	0.090	0.040	0.750	0.675	0.300
TBJA105*035L□#@0^++	A	1	35	3	0.35	3.5	7	4	6	6	0.075	0.158	0.142	0.063	0.474	0.427	0.190
TBJB105*035C□#@0^++	B	1	35	6.5	0.35	3.5	4.2	4	6	6	0.085	0.114	0.103	0.046	0.743	0.669	0.297
TBJB105*035L□#@0^++	B	1	35	2	0.35	3.5	7	4	6	6	0.085	0.206	0.186	0.082	0.412	0.371	0.165
TBJA155*035C□#@0^++	A	1.5	35	7.5	0.525	5.25	10.5	6	8	9	0.075	0.100	0.090	0.040	0.750	0.675	0.300
TBJB155*035C□#@0^++	B	1.5	35	5.2	0.525	5.25	10.5	6	8	9	0.085	0.128	0.115	0.051	0.665	0.598	0.266
TBJB155*035L□#@0^++	B	1.5	35	2.5	0.525	5.25	10.5	6	9	10	0.085	0.184	0.166	0.074	0.461	0.415	0.184
TBJC155*035C□#@0^++	C	1.5	35	4.5	0.525	5.25	6.3	6	8	9	0.110	0.156	0.141	0.063	0.704	0.633	0.281
TBJA225*035C□#@0^++	A	2.2	35	4.5	0.77	7.7	15.4	6	9	9	0.075	0.129	0.116	0.052	0.581	0.523	0.232
TBJA225*035L□#@0^++	A	2.2	35	1.5	0.77	7.7	15.4	6	9	10	0.075	0.224	0.201	0.089	0.335	0.302	0.134
TBJB225*035C□#@0^++	B	2.2	35	4.2	0.77	7.7	15.4	6	8	9	0.085	0.142	0.128	0.057	0.597	0.538	0.239
TBJB225*035L□#@0^++	B	2.2	35	2	0.77	7.7	15.4	6	8	9	0.085	0.206	0.186	0.082	0.412	0.371	0.165
TBJC225*035C□#@0^++	C	2.2	35	3.5	0.77	7.7	9.24	6	8	9	0.110	0.177	0.160	0.071	0.620	0.558	0.248
TBJC225*035L□#@0^++	C	2.2	35	1	0.77	7.7	15.4	6	9	10	0.110	0.332	0.298	0.133	0.332	0.298	0.133
TBJB335*035C□#@0^++	B	3.3	35	3.5	1.155	11.55	23.1	6	8	9	0.085	0.156	0.140	0.062	0.545	0.491	0.218
TBJB335*035L□#@0^++	B	3.3	35	1	1.155	11.55	23.1	6	9	10	0.085	0.292	0.262	0.117	0.292	0.262	0.117
TBJC335*035C□#@0^++	C	3.3	35	2.5	1.155	11.55	13.86	6	8	9	0.110	0.210	0.189	0.084	0.524	0.472	0.210
TBJC335*035L□#@0^++	C	3.3	35	0.7	1.155	11.55	23.1	6	9	10	0.110	0.396	0.357	0.159	0.277	0.250	0.111
TBJB475*035C□#@0^++	B	4.7	35	3.1	1.645	16.45	32.9	6	8	9	0.085	0.166	0.149	0.066	0.513	0.462	0.205
TBJB475*035L□#@0^++	B	4.7	35	0.7	1.645	16.45	32.9	6	8	8	0.085	0.348	0.314	0.139	0.244	0.220	0.098
TBJC475*035C□#@0^++	C	4.7	35	2.2	1.645	16.45	32.9	6	8	9	0.110	0.224	0.201	0.089	0.492	0.443	0.197
TBJC475*035L□#@0^++	C	4.7	35	0.6	1.645	16.45	32.9	6	8	9	0.110	0.428	0.385	0.171	0.257	0.231	0.103
TBJD475*035C□#@0^++	D	4.7	35	1.5	1.645	16.45	19.74	6	8	9	0.150	0.316	0.285	0.126	0.474	0.427	0.190
TBJD475*035L□#@0^++	D	4.7	35	0.5	1.645	16.45	32.9	6	8	9	0.150	0.548	0.493	0.219	0.274	0.246	0.110
TBJC685*035C□#@0^++	C	6.8	35	1.8	2.38	23.8	47.6	6	9	9	0.110	0.247	0.222	0.099	0.445	0.400	0.178
TBJC685*035L□#@0^++	C	6.8	35	0.35	2.38	23.8	47.6	6	9	10	0.110	0.561	0.505	0.224	0.196	0.177	0.078
TBJD685*035C□#@0^++	D	6.8	35	1.3	2.38	23.8	28.56	6	9	9	0.150	0.340	0.306	0.136	0.442	0.397	0.177
TBJD685*035L□#@0^++	D	6.8	35	0.5	2.38	23.8	47.6	6	9	9	0.150	0.548	0.493	0.219	0.274	0.246	0.110
TBJC106*035C□#@0^++	C	10	35	1.6	3.5	35	70	6	9	9	0.110	0.262	0.236	0.105	0.420	0.378	0.168
TBJC106*035L□#@0^++	C	10	35	0.6	3.5	35	70	6	9	9	0.110	0.428	0.385	0.171	0.257	0.231	0.103
TBJD106*035C□#@0^++	D	10	35	1	3.5	35	70	6	9	9	0.150	0.387	0.349	0.155	0.387	0.349	0.155
TBJD106*035L□#@0^++	D	10	35	0.3	3.5	35	70	6	9	9	0.150	0.707	0.636	0.283	0.212	0.191	0.085
TBJE106*035C□#@0^++	E	10	35	0.25	3.5	35	70	6	9	10	0.165	0.812	0.731	0.325	0.203	0.183	0.081
TBJE106*035L□#@0^++	E	10	35	0.2	3.5	35	70	6	9	10	0.165	0.908	0.817	0.363	0.182	0.163	0.073

All technical data relates to an ambient temperature of +25°C. Capacitance and DF are measured at 120Hz, 0.5V RMS with a maximum DC bias of 2.2 volts. DCL is measured at rated voltage after 5 minutes.

NOTE: KYOCERA AVX reserves the right to supply a higher voltage rating or tighter tolerance part in the same case size, to the same reliability standards.

TBJ SERIES

COTS-Plus



RATING & PART NUMBER REFERENCE		Parametric Specifications by Rating per MIL-PRF-55365/4									Typical RMS Ripple Data by Rating						
		Cap @ 120Hz	DC Rated Voltage	ESR @ 100kHz	DCL max			DF Max			Power Dissipation	25°C Ripple Current	85°C Ripple Current	125°C Ripple Current	25°C Ripple Voltage	85°C Ripple Voltage	125°C Ripple Voltage
					+25°C	+85°C	+125°C	+25°C	+(85/125)°C	-55°C							
COTS-Plus P/N	Case	µF @ 25°C	V @ +85°C	Ohms @ +25°C	(µA)	(µA)	(µA)	(%)	(%)	(%)	W	A (100kHz)	A (100kHz)	A (100kHz)	V (100kHz)	V (100kHz)	V (100kHz)
TBJC156*035C□#@0***	C	15	35	1.4	5.25	52.5	105	6	9	9	0.110	0.280	0.252	0.112	0.392	0.353	0.157
TBJC156*035L□#@0***	C	15	35	0.35	5.25	52.5	105	6	9	10	0.110	0.561	0.505	0.224	0.196	0.177	0.078
TBJD156*035C□#@0***	D	15	35	0.9	5.25	52.5	105	6	9	9	0.150	0.408	0.367	0.163	0.367	0.331	0.147
TBJD156*035L□#@0***	D	15	35	0.3	5.25	52.5	105	6	9	9	0.150	0.707	0.636	0.283	0.212	0.191	0.085
TBJD226*035C□#@0***	D	22	35	0.9	7.7	77	154	6	9	9	0.150	0.408	0.367	0.163	0.367	0.331	0.147
TBJD226*035L□#@0***	D	22	35	0.4	7.7	77	154	6	9	9	0.150	0.612	0.551	0.245	0.245	0.220	0.098
TBJE226*035C□#@0***	E	22	35	0.9	7.7	77	154	6	9	9	0.165	0.428	0.385	0.171	0.385	0.347	0.154
TBJE226*035L□#@0***	E	22	35	0.3	7.7	77	154	6	9	9	0.165	0.742	0.667	0.297	0.222	0.200	0.089
TBJD336*035C□#@0***	D	33	35	0.9	11.55	115.5	231	6	9	9	0.150	0.408	0.367	0.163	0.367	0.331	0.147
TBJD336*035L□#@0***	D	33	35	0.3	11.55	115.5	231	6	9	9	0.150	0.707	0.636	0.283	0.212	0.191	0.085
TBJE336*035C□#@0***	E	33	35	0.25	11.55	115.5	231	6	9	10	0.165	0.812	0.731	0.325	0.203	0.183	0.081
TBJE336*035L□#@0***	E	33	35	0.1	11.55	115.5	231	6	8	10	0.165	1.285	1.156	0.514	0.128	0.116	0.051
TBJV336*035L□#@0***	V	33	35	0.2	11.55	115.5	231	6	9	10	0.250	1.118	1.006	0.447	0.224	0.201	0.089
TBJE476*035C□#@0***	E	47	35	0.25	16.45	164.5	329	6	8	10	0.165	0.812	0.731	0.325	0.203	0.183	0.081
TBJE476*035L□#@0***	E	47	35	0.2	16.45	164.5	329	6	9	9	0.165	0.908	0.817	0.363	0.182	0.163	0.073
TBJV476*035C□#@0***	V	47	35	0.4	16.45	164.5	329	6	9	10	0.250	0.791	0.712	0.316	0.316	0.285	0.126
TBJV476*035L□#@0***	V	47	35	0.2	16.45	164.5	329	6	10	10	0.250	1.118	1.006	0.447	0.224	0.201	0.089
TBJV686*035C□#@0***	V	68	35	0.2	23.8	238	476	6	9	10	0.250	1.118	1.006	0.447	0.224	0.201	0.089
TBJV686*035L□#@0***	V	68	35	0.15	23.8	238	476	6	9	10	0.250	1.291	1.162	0.516	0.194	0.174	0.077
TBJA104*050C□#@0***	A	0.15	50	22	0.05	0.5	0.6	4	8	8	0.075	0.058	0.053	0.023	1.285	1.156	0.514
TBJA154*050C□#@0***	A	0.15	50	21	0.02	0.2	0.4	4	6	6	0.075	0.060	0.054	0.024	1.255	1.129	0.502
TBJA154*050L□#@0***	A	0.15	50	9	0.075	0.75	1.5	4	6	6	0.075	0.091	0.082	0.037	0.822	0.739	0.329
TBJB154*050C□#@0***	B	0.15	50	17	0.075	0.75	0.9	4	6	6	0.085	0.071	0.064	0.028	1.202	1.082	0.481
TBJA224*050C□#@0***	A	0.22	50	18	0.11	1.1	2.2	4	6	6	0.075	0.065	0.058	0.026	1.162	1.046	0.465
TBJA224*050L□#@0***	A	0.22	50	7	0.11	1.1	2.2	4	6	6	0.075	0.104	0.093	0.041	0.725	0.652	0.290
TBJB224*050C□#@0***	B	0.22	50	14	0.11	1.1	1.32	4	6	6	0.085	0.078	0.070	0.031	1.091	0.982	0.436
TBJB334*050C□#@0***	B	0.33	50	12	0.165	1.65	1.98	4	6	6	0.085	0.084	0.076	0.034	1.010	0.909	0.404
TBJC474*050C□#@0***	C	0.47	50	8	0.235	2.35	2.82	4	6	6	0.110	0.117	0.106	0.047	0.938	0.844	0.375
TBJA684*050C□#@0***	A	0.68	50	7.9	0.34	3.4	6.8	4	6	8	0.075	0.097	0.088	0.039	0.770	0.693	0.308
TBJC684*050C□#@0***	C	0.68	50	7	0.34	3.4	4.08	4	6	6	0.110	0.125	0.113	0.050	0.877	0.790	0.351
TBJC105*050C□#@0***	C	1	50	6	0.5	5	6	4	6	6	0.110	0.135	0.122	0.054	0.812	0.731	0.325
TBJC105*050L□#@0***	C	1	50	2.5	0.5	5	10	4	6	6	0.110	0.210	0.189	0.084	0.524	0.472	0.210
TBJC155*050C□#@0***	C	1.5	50	5	0.75	7.5	15	6	8	9	0.110	0.148	0.133	0.059	0.742	0.667	0.297
TBJC155*050L□#@0***	C	1.5	50	1.5	0.75	7.5	15	6	9	10	0.110	0.271	0.244	0.108	0.406	0.366	0.162
TBJD155*050C□#@0***	D	1.5	50	4	0.75	7.5	9	6	8	9	0.150	0.194	0.174	0.077	0.775	0.697	0.310
TBJD225*050C□#@0***	D	2.2	50	2.5	1.1	11	13.2	6	8	9	0.150	0.245	0.220	0.098	0.612	0.551	0.245
TBJD225*050L□#@0***	D	2.2	50	1.2	1.1	11	22	6	9	10	0.150	0.354	0.318	0.141	0.424	0.382	0.170
TBJD335*050C□#@0***	D	3.3	50	2	1.65	16.5	19.8	6	9	9	0.150	0.274	0.246	0.110	0.548	0.493	0.219
TBJD335*050L□#@0***	D	3.3	50	0.8	1.65	16.5	33	6	9	10	0.150	0.433	0.390	0.173	0.346	0.312	0.139
TBJD475*050C□#@0***	D	4.7	50	1.5	2.35	23.5	28.2	6	9	9	0.150	0.316	0.285	0.126	0.474	0.427	0.190
TBJD475*050L□#@0***	D	4.7	50	0.3	2.35	23.5	47	6	9	9	0.150	0.707	0.636	0.283	0.212	0.191	0.085
TBJD685*050C□#@0***	D	6.8	50	1	3.4	34	68	6	9	9	0.150	0.387	0.349	0.155	0.387	0.349	0.155
TBJD685*050L□#@0***	D	6.8	50	0.5	3.4	34	68	6	9	9	0.150	0.548	0.493	0.219	0.274	0.246	0.110
TBJE106*050C□#@0***	E	10	50	0.5	5	50	100	6	9	10	0.165	0.574	0.517	0.230	0.287	0.259	0.115
TBJE106*050L□#@0***	E	10	50	0.4	5	50	100	6	9	10	0.165	0.642	0.578	0.257	0.257	0.231	0.103
TBJV106*050C□#@0***	V	10	50	0.65	5	50	100	3	6	6	0.250	0.620	0.558	0.248	0.403	0.363	0.161
TBJD156*050C□#@0***	D	15	50	0.6	7.5	75	150	4	6	6	0.150	0.500	0.450	0.200	0.300	0.270	0.120
TBJE156*050C□#@0***	E	15	50	0.6	7.5	75	150	8	10	12	0.165	0.524	0.472	0.210	0.315	0.283	0.126
TBJE156*050L□#@0***	E	15	50	0.25	7.5	75	150	6	9	10	0.165	0.812	0.731	0.325	0.203	0.183	0.081
TBJV226*050C□#@0***	V	22	50	0.6	11	110	220	8	10	12	0.250	0.645	0.581	0.258	0.387	0.349	0.155
TBJV226*050L□#@0***	V	22	50	0.39	11	110	220	8	10	12	0.250	0.801	0.721	0.320	0.312	0.281	0.125

All technical data relates to an ambient temperature of +25°C. Capacitance and DF are measured at 120Hz, 0.5V RMS with a maximum DC bias of 2.2 volts. DCL is measured at rated voltage after 5 minutes.

NOTE: KYOCERA AVX reserves the right to supply a higher voltage rating or tighter tolerance part in the same case size, to the same reliability standards.

TBJ SERIES

COTS-Plus – Space Level

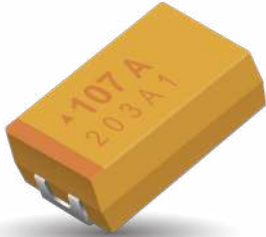

The TBJ COTS-Plus – Space Level series has been refined to incorporate only those commercially upscreened ratings which have been deemed suitable for mission critical and space level applications.

These capacitors have a more conservative design approach when compared to other up-screened components utilizing established CV powders and higher dielectric formation ratios. The DCL is typically 25% lower while still offering aggressive ESR values.

Currently there are 6 case sizes with the wide capacitance range available in a given voltage range.

These ratings are available with Weibull grading (B and C), surge current testing MIL-PRF-55365 (A, B, C), optional Group A from MIL-PRF-55365, and the extensive SRC9000 space level screening.

For moisture sensitivity levels please refer to the High Reliability Tantalum MSL section located in the back of the High Reliability Tantalum Catalog.

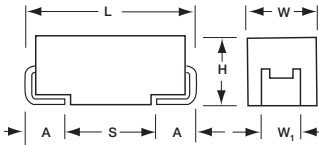

CASE DIMENSIONS: millimeters (inches)

Code	EIA Code	EIA Metric	L±0.20 (0.008)	W+0.20 (0.008) -0.10 (0.004)	H+0.20 (0.008) -0.10 (0.004)	W ₁ ±0.20 (0.008)	A+0.30 (0.012) -0.20 (0.008)	S Min.
A	1206	3216-18	3.20 (0.126)	1.60 (0.063)	1.60 (0.063)	1.20 (0.047)	0.80 (0.031)	1.10 (0.043)
B	1210	3528-21	3.50 (0.138)	2.80 (0.110)	1.90 (0.075)	2.20 (0.087)	0.80 (0.031)	1.40 (0.055)
C	2312	6032-28	6.00 (0.236)	3.20 (0.126)	2.60 (0.102)	2.20 (0.087)	1.30 (0.051)	2.90 (0.114)
D	2917	7343-31	7.30 (0.287)	4.30 (0.169)	2.90 (0.114)	2.40 (0.094)	1.30 (0.051)	4.40 (0.173)
E	2917	7343-43	7.30 (0.287)	4.30 (0.169)	4.10 (0.162)	2.40 (0.094)	1.30 (0.051)	4.40 (0.173)
U	2924	7361-43	7.30 (0.287)	6.10 (0.240)	4.10 (0.162)	3.10 (0.122)	1.30 (0.051)	4.40 (0.173)

W₁ dimension applies to the termination width for A dimensional area only.

MARKING

A, B, C, D, E, V CASE

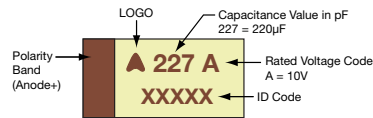

CAPACITANCE AND RATED VOLTAGE, V_R (VOLTAGE CODE) RANGE (LETTER DENOTES CASE SIZE)

Capacitance		Rated Voltage DC (V _R) at 85°C						
µF	Code	6V (J)	10V (A)	16V (C)	20V (D)	25V (E)	35V (V)	50V (T)
0.10	104						A(20000)	
0.15	154						A(6000, 16470)	
0.22	224						A(6000, 13710)	A(7000, 7500)
0.33	334						A(6000, 11280)	A(7000)
0.47	474					A(7000, 9530)	A(4000, 9530)	B(5000)
0.68	684					A(6000, 7980)	A(6000, 8000)	B(2000, 4000)
1.0	105			A(10000)	A(3000, 6630)	A(3000, 6630)	A(3000, 6630) B(2000, 3400)	B(2000, 3400) C(3000)
1.5	155		A(7000)		A(3000, 5640)	A(3000, 5640) B(5000)	A(2000, 3100) B(2500, 5460)	C(1500, 2500)
2.2	225		A(7000)	A(3500, 4550)	A(3000, 4550)	A(1600, 2900) B(1200, 4550)	B(2000, 4550)	C(1000, 1700) D(1200, 2000)
3.3	335			A(3500, 3750) B(4500)	A(2500, 3750) B(1300, 3740)	B(2000, 3740)	B(1000, 3740) C(800, 1840) D(2000)	C(1000, 1400) D(800, 1100)
4.7	475		A(2000, 2900)	A(2000, 3160) B(1500, 3160)	A(1800, 2500) B(1000, 3160)	B(1000, 3160)	B(1500, 2200) C(600, 1410) D(1500)	D(600, 900)
6.8	685		A(1800, 4000) B(3000)	A(1500, 2000) B(1200, 2650) C(2500)	B(1000, 2650) C(2000)	B(1000, 1500) C(600, 1070)	C(600, 1070) D(1300)	D(700)
10	106	A(1500, 2000) B(3000)	A(1800, 2200) B(800, 2200)	B(800, 2200) C(2000)	B(1000, 2200) C(500, 800)	C(600, 800) D(1200)	C(600, 800) D(250, 800)	E(300, 700)
15	156	A(1500, 2030) B(700, 2030)	A(1000, 1800) B(600, 2030) C(2000)	B(800, 2000)	B(500, 1400) C(400, 750) D(1100)	C(500, 720) D(300, 720)	D(225, 720)	U(500)
22	226	A(900, 1700) B(600, 1880) C(2000)	B(700, 1800)	B(600, 1100) C(350, 700) D(1100)	C(400, 650) D(150, 650)	D(300, 650)	D(200, 650)	U(500)
33	336	B(600, 1740) C(1800)	B(650, 1000) C(300, 590) D(1100)	C(300, 590)	C(300, 590) D(250, 590)	D(400, 590)	E(250, 590)	
47	476	B(500, 1620) C(250, 540)	C(300, 540) D(200, 340)	C(350, 540) D(200, 340)	D(200, 540)	D(250, 540) E(150, 540)	U(200, 400)	
68	686	C(200, 490)	C(300, 490)	D(150, 490)	D(200, 490) E(125, 490)	U(500)		
100	107	C(300, 440)	C(200, 500) D(150, 440) E(100, 440)	D(150, 450) E(150, 450)	E(150, 300)	U(500)		
150	157	C(300, 500) D(150, 400)	D(150, 400) E(150, 400)	E(150, 300)	U(250, 500)			
220	227	D(150, 360)	D(500) E(150, 360)	U(200, 500)				
330	337	D(400) E(150, 330)	E(100, 300)	U(200, 400)				
470	477	E(200, 250)	U(200, 400)					
680	687	U(250, 500)						

Available Ratings: ESR limits quoted in brackets (mOhms)

Notes: Voltage ratings are minimum values. KYOCERA AVX reserves the right to supply higher ratings in the same case size, to the same reliability standards.

TBJ SERIES

COTS-Plus – Space Level

HOW TO ORDER

PART NUMBER:

TBJ	D	227	*	035	R	B	S	Z	0	^	++
Type	Case Size	Capacitance Code pF code: 1st two digits represent significant figures 3rd digit represents multiplier (number of zeros to follow)	Capacitance Tolerance M = ±20% K = ±10%	Voltage Code 006 = 6Vdc 010 = 10Vdc 016 = 16Vdc 020 = 20Vdc 025 = 25Vdc 035 = 35Vdc 050 = 50Vdc	ESR R = Std ESR J = Low ESR	Packaging B = Bulk R = 7" T&R S = 13" T&R W = Waffle	Inspection Level S = Std. Conformance L = Group A	Reliability Grade Weibull: B = 0.1%/1000 hrs. 90% conf. C = 0.01%/1000 hrs. 90% conf. Z = Non-ER	Qualification Level 0 = N/A 9 = SRC9000 T=T Level	Termination Finish H = Solder Plated 0 = Fused Solder Plated 8 = Hot Solder Dipped 9 = Gold Plated 7 = Matte Sn (COTS-Plus only)	Surge Test Option 00 = None 23 = 10 Cycles, +25°C 24 = 10 Cycles, -55°C & +85°C 45 = 10 cycles, -55°C & +85°C before Weibull

*Waffle packaging not available for the TBJ U case

*For Gold Plated Termination Finish, contact the factory for availability.



For RoHS compliant products, please select correct termination style.

SPACE LEVEL SCREENING TO SRC9000 OR T LEVEL*:

TBJ	D	227	*	035	R	B	L	C	#	^	++
Type	Case Size	Capacitance Code pF code: 1st two digits represent significant figures 3rd digit represents multiplier (number of zeros to follow)	Capacitance Tolerance M = ±20% K = ±10%	Voltage Code 006 = 6Vdc 010 = 10Vdc 016 = 16Vdc 020 = 20Vdc 025 = 25Vdc 035 = 35Vdc 050 = 50Vdc	ESR R = Std ESR J = Low ESR	Packaging B = Bulk R = 7" T&R S = 13" T&R W = Waffle See page 8 for additional packaging options.	Inspection Level L = Group A	Reliability Grade C = 0.01%/1000 hrs. 90% conf.	Qualification Level 9 = SRC9000 T=T Level	Termination Finish H = Solder Plated 0 = Fused Solder Plated 8 = Hot Solder Dipped 9 = Gold Plated	Surge Test Option 45 = 10 cycles, -55°C & +85°C before Weibull GC = Group C Testing and Data OR = TOR compliant testing and data

*Waffle packaging not available for the TBJ U case

*The product in this series is non-QPL. See Test Options chart for screening available.



For RoHS compliant products, please select correct termination style.

TECHNICAL SPECIFICATIONS

Technical Data:	All technical data relate to an ambient temperature of 25°C									
Capacitance Range:	0.10 µF to 680 µF									
Capacitance Tolerance:	±10%; ±20%									
Leakage Current DCL:	0.0075CV									
Rated Voltage (V _R)	≤ 85°C:	6	10	16	20	25	35	50		
Category Voltage (V _C)	≤125°C:	4	7	10	13	17	23	33		
Surge Voltage (V _S)	≤ 85°C:	8	13	20	26	32	46	65		
Surge Voltage (V _S)	≤125°C:	5	8	13	16	20	28	40		
Temperature Range:	-55°C to +125°C									

TBJ SERIES

COTS-Plus – Space Level



RATING & PART NUMBER REFERENCE			Parametric Specifications by Rating									Typical RMS Ripple Data by Rating						
			Cap @ 120Hz µF @ 25°C	DC Rated Voltage V @ +85°C	ESR @ 100kHz mΩ @ +25°C	DCL max			DF Max			Power Dissipation W	25°C Ripple mA (100kHz)	85°C Ripple mA (100kHz)	125°C Ripple mA (100kHz)	25°C Ripple mV (100kHz)	85°C Ripple mV (100kHz)	125°C Ripple mV (100kHz)
						+25°C (µA)	+85°C (µA)	+125°C (µA)	+25°C (%)	+85°C (%)	+125°C (%)							
P/N	Space Level P/N	Case																
TBJA106*006 R □ # @ 0^++	TBJA106*006 R □ L C # ^++	A	10	6	2200	0.45	4.5	9	6	9	10	0.075	185	166	74	406	366	162
TBJA106*006 J □ # @ 0^++	TBJA106*006 J □ L C # ^++	A	10	6	1500	0.45	4.5	9	6	9	10	0.075	224	201	89	335	302	134
TBJB106*006 R □ # @ 0^++	TBJB106*006 R □ L C # ^++	B	10	6	3000	0.45	4.5	9	6	9	10	0.085	168	151	67	505	454	202
TBJA156*006 R □ # @ 0^++	TBJA156*006 R □ L C # ^++	A	15	6	2030	0.68	6.8	13.6	6	9	10	0.075	192	173	77	390	351	156
TBJA156*006 J □ # @ 0^++	TBJA156*006 J □ L C # ^++	A	15	6	1500	0.68	6.8	13.6	6	9	10	0.075	224	201	89	335	302	134
TBJB156*006 R □ # @ 0^++	TBJB156*006 R □ L C # ^++	B	15	6	2030	0.68	6.8	13.6	6	9	10	0.085	205	184	82	415	374	166
TBJB156*006 J □ # @ 0^++	TBJB156*006 J □ L C # ^++	B	15	6	700	0.68	6.8	13.6	6	9	10	0.085	348	314	139	244	220	98
TBJA226*006 R □ # @ 0^++	TBJA226*006 R □ L C # ^++	A	22	6	1700	0.99	9.9	19.8	6	9	10	0.075	210	189	84	357	321	143
TBJA226*006 J □ # @ 0^++	TBJA226*006 J □ L C # ^++	A	22	6	900	0.99	9.9	19.8	6	9	10	0.075	289	260	115	260	234	104
TBJB226*006 R □ # @ 0^++	TBJB226*006 R □ L C # ^++	B	22	6	1880	0.99	9.9	19.8	6	9	10	0.085	213	191	85	400	360	160
TBJB226*006 J □ # @ 0^++	TBJB226*006 J □ L C # ^++	B	22	6	600	0.99	9.9	19.8	6	9	10	0.085	376	339	151	226	203	90
TBJC226*006 R □ # @ 0^++	TBJC226*006 R □ L C # ^++	C	22	6	2000	0.99	9.9	19.8	6	9	10	0.110	235	211	94	469	422	188
TBJB336*006 R □ # @ 0^++	TBJB336*006 R □ L C # ^++	B	33	6	1740	1.5	15	30	6	9	10	0.085	221	199	88	385	346	154
TBJB336*006 J □ # @ 0^++	TBJB336*006 J □ L C # ^++	B	33	6	600	1.5	15	30	6	9	10	0.085	376	339	151	226	203	90
TBJC336*006 R □ # @ 0^++	TBJC336*006 R □ L C # ^++	C	33	6	1800	1.5	15	30	6	9	10	0.110	247	222	99	445	400	178
TBJB476*006 R □ # @ 0^++	TBJB476*006 R □ L C # ^++	B	47	6	1620	2.1	21	42	6	9	10	0.085	229	206	92	371	334	148
TBJB476*006 J □ # @ 0^++	TBJB476*006 J □ L C # ^++	B	47	6	500	2.1	21	42	6	9	10	0.085	412	371	165	206	186	82
TBJC476*006 R □ # @ 0^++	TBJC476*006 R □ L C # ^++	C	47	6	540	2.1	21	42	6	9	10	0.110	451	406	181	244	219	97
TBJC476*006 J □ # @ 0^++	TBJC476*006 J □ L C # ^++	C	47	6	250	2.1	21	42	6	9	10	0.110	663	597	265	166	149	66
TBJC686*006 R □ # @ 0^++	TBJC686*006 R □ L C # ^++	C	68	6	490	3.1	31	62	6	9	10	0.110	474	426	190	232	209	93
TBJC686*006 J □ # @ 0^++	TBJC686*006 J □ L C # ^++	C	68	6	200	3.1	31	62	6	9	10	0.110	742	667	297	148	133	59
TBJC107*006 R □ # @ 0^++	TBJC107*006 R □ L C # ^++	C	100	6	440	4.5	45	90	6	9	10	0.110	500	450	200	220	198	88
TBJC107*006 J □ # @ 0^++	TBJC107*006 J □ L C # ^++	C	100	6	300	4.5	45	90	6	9	10	0.110	606	545	242	182	163	73
TBJC157*006 R □ # @ 0^++	TBJC157*006 R □ L C # ^++	C	150	6	500	6.8	68	136	8	10	12	0.110	469	422	188	235	211	94
TBJC157*006 J □ # @ 0^++	TBJC157*006 J □ L C # ^++	C	150	6	300	6.8	68	136	8	10	12	0.110	606	545	242	182	163	73
TBJD157*006 R □ # @ 0^++	TBJD157*006 R □ L C # ^++	D	150	6	400	6.8	68	136	6	9	10	0.150	612	551	245	245	220	98
TBJD157*006 J □ # @ 0^++	TBJD157*006 J □ L C # ^++	D	150	6	150	6.8	68	136	6	9	10	0.150	1000	900	400	150	135	60
TBJD227*006 R □ # @ 0^++	TBJD227*006 R □ L C # ^++	D	220	6	360	9.9	99	198	8	10	12	0.150	645	581	258	232	209	93
TBJD227*006 J □ # @ 0^++	TBJD227*006 J □ L C # ^++	D	220	6	150	9.9	99	198	8	10	12	0.150	1000	900	400	150	135	60
TBJD337*006 R □ # @ 0^++	TBJD337*006 R □ L C # ^++	D	330	6	400	14	140	280	8	10	12	0.150	612	551	245	245	220	98
TBJE337*006 R □ # @ 0^++	TBJE337*006 R □ L C # ^++	E	330	6	330	14	140	280	8	10	12	0.165	707	636	283	233	210	93
TBJE337*006 J □ # @ 0^++	TBJE337*006 J □ L C # ^++	E	330	6	150	14	140	280	8	10	12	0.165	1049	944	420	157	142	63
TBJE477*006 R □ # @ 0^++	TBJE477*006 R □ L C # ^++	E	470	6	250	21	210	420	8	10	12	0.165	812	731	325	203	183	81
TBJE477*006 J □ # @ 0^++	TBJE477*006 J □ L C # ^++	E	470	6	200	21	210	420	8	10	12	0.165	908	817	363	182	163	73
TBJU687*006 R □ # @ 0^++	TBJU687*006 R □ L C # ^++	U	680	6	500	30	300	600	30	45	45	0.165	574	517	230	287	259	115
TBJU687*006 J □ # @ 0^++	TBJU687*006 J □ L C # ^++	U	680	6	250	30	300	600	30	45	45	0.165	812	731	325	203	183	81
TBJA155*010 R □ # @ 0^++	TBJA155*010 R □ L C # ^++	A	1.5	10	7000	0.3	3	6	6	9	10	0.075	104	93	41	725	652	290
TBJA225*010 R □ # @ 0^++	TBJA225*010 R □ L C # ^++	A	2.2	10	7000	0.3	3	6	6	9	10	0.075	104	93	41	725	652	290
TBJA475*010 R □ # @ 0^++	TBJA475*010 R □ L C # ^++	A	4.7	10	2900	0.35	3.5	7	6	9	10	0.075	161	145	64	466	420	187
TBJA475*010 J □ # @ 0^++	TBJA475*010 J □ L C # ^++	A	4.7	10	2000	0.35	3.5	7	6	9	10	0.075	194	174	77	387	349	155
TBJA685*010 R □ # @ 0^++	TBJA685*010 R □ L C # ^++	A	6.8	10	2650	0.51	5.1	10.2	6	9	10	0.075	168	151	67	446	401	178
TBJA685*010 J □ # @ 0^++	TBJA685*010 J □ L C # ^++	A	6.8	10	1800	0.51	5.1	10.2	6	9	10	0.075	204	184	82	367	331	147
TBJB685*010 R □ # @ 0^++	TBJB685*010 R □ L C # ^++	B	6.8	10	3000	0.51	5.1	10.2	6	9	10	0.085	168	151	67	505	454	202
TBJA106*010 R □ # @ 0^++	TBJA106*010 R □ L C # ^++	A	10	10	2200	0.75	7.5	15	6	9	10	0.075	185	166	74	406	366	162
TBJA106*010 J □ # @ 0^++	TBJA106*010 J □ L C # ^++	A	10	10	1800	0.75	7.5	15	6	9	10	0.075	204	184	82	367	331	147
TBJB106*010 R □ # @ 0^++	TBJB106*010 R □ L C # ^++	B	10	10	2200	0.75	7.5	15	6	9	10	0.085	197	177	79	432	389	173
TBJB106*010 J □ # @ 0^++	TBJB106*010 J □ L C # ^++	B	10	10	800	0.75	7.5	15	6	9	10	0.085	326	293	130	261	235	104
TBJA156*010 R □ # @ 0^++	TBJA156*010 R □ L C # ^++	A	15	10	1800	1.1	11	22	6	9	10	0.075	204	184	82	367	331	147
TBJA156*010 J □ # @ 0^++	TBJA156*010 J □ L C # ^++	A	15	10	1000	1.1	11	22	6	9	10	0.075	274	246	110	274	246	110
TBJB156*010 R □ # @ 0^++	TBJB156*010 R □ L C # ^++	B	15	10	2030	1.1	11	22	6	9	10	0.085	205	184	82	415	374	166
TBJB156*010 J □ # @ 0^++	TBJB156*010 J □ L C # ^++	B	15	10	600	1.1	11	22	6	9	10	0.085	376	339	151	226	203	90
TBJC156*010 R □ # @ 0^++	TBJC156*010 R □ L C # ^++	C	15	10	2000	1.1	11	22	6	9	10	0.110	235	211	94	469	422	188
TBJB226*010 R □ # @ 0^++	TBJB226*010 R □ L C # ^++	B	22	10	1880	1.7	17	34	6	9	10	0.085	213	191	85	400	360	160
TBJB226*010 J □ # @ 0^++	TBJB226*010 J □ L C # ^++	B	22	10	700	1.7	17	34	6	9	10	0.085	348	314	139	244	220	98
TBJB336*010 R □ # @ 0^++	TBJB336*010 R □ L C # ^++	B	33	10	1000	2.5	25	50	6	9	10	0.085	292	262	117	292	262	117
TBJB336*010 J □ # @ 0^++	TBJB336*010 J □ L C # ^++	B	33	10	650	2.5	25	50	6	9	10	0.085	362	325	145	235	212	94
TBJC336*010 R □ # @ 0^++	TBJC336*010 R □ L C # ^++	C	33	10	590	2.5	25	50	6	9	10	0.110	432	389	173	255	229	102
TBJC336*010 J □ # @ 0^++	TBJC336*010 J □ L C # ^++	C	33	10	300	2.5	25	50	6	9	10	0.110	606	545	242	182	163	73

All technical data relates to an ambient temperature of +25°C. Capacitance and DF are measured at 120Hz, 0.5V RMS with a maximum DC bias of 2.2 volts. DCL is measured at rated voltage after 5 minutes.

NOTE: KYOCERA AVX reserves the right to supply a higher voltage rating or tighter tolerance part in the same case size, to the same reliability standards.



TBJ SERIES

COTS-Plus – Space Level

RATING & PART NUMBER REFERENCE			Parametric Specifications by Rating									Typical RMS Ripple Data by Rating						
			Cap @ 120Hz µF @ 25°C	DC Rated Voltage V @ +85°C	ESR @ 100kHz mOhms @ +25°C	DCL max			DF Max			Power Dissipation W	25°C Ripple mA (100kHz)	85°C Ripple mA (100kHz)	125°C Ripple mA (100kHz)	25°C Ripple mV (100kHz)	85°C Ripple mV (100kHz)	125°C Ripple mV (100kHz)
						+25°C (µA)	+85°C (µA)	+125°C (µA)	+25°C (%)	+85/125 °C (%)	-55°C (%)							
P/N	Space Level P/N	Case																
TBJD336*010 R □ # @ 0^++	TBJD336*010 R □ LC #^++	D	33	10	1100	2.5	25	50	6	9	10	0.150	369	332	148	406	366	162
TBJC476*010 R □ # @ 0^++	TBJC476*010 R □ LC #^++	C	47	10	540	3.5	35	70	6	9	10	0.110	451	406	181	244	219	97
TBJC476*010 J □ # @ 0^++	TBJC476*010 J □ LC #^++	C	47	10	300	3.5	35	70	6	9	10	0.110	606	545	242	182	163	73
TBJD476*010 R □ # @ 0^++	TBJD476*010 R □ LC #^++	D	47	10	400	3.5	35	70	6	9	10	0.150	612	551	245	245	220	98
TBJC686*010 R □ # @ 0^++	TBJC686*010 R □ LC #^++	C	68	10	490	5.1	51	102	6	9	10	0.110	474	426	190	232	209	93
TBJC686*010 J □ # @ 0^++	TBJC686*010 J □ LC #^++	C	68	10	300	5.1	51	102	6	9	10	0.110	606	545	242	182	163	73
TBJC107*010 R □ # @ 0^++	TBJC107*010 R □ LC #^++	C	100	10	500	7.5	75	150	8	10	12	0.110	469	422	188	235	211	94
TBJC107*010 J □ # @ 0^++	TBJC107*010 J □ LC #^++	C	100	10	200	7.5	75	150	8	10	12	0.110	742	667	297	148	133	59
TBJD107*010 R □ # @ 0^++	TBJD107*010 R □ LC #^++	D	100	10	440	7.5	75	150	6	9	10	0.150	584	525	234	257	231	103
TBJD107*010 J □ # @ 0^++	TBJD107*010 J □ LC #^++	D	100	10	150	7.5	75	150	6	9	10	0.150	1000	900	400	150	135	60
TBJE107*010 R □ # @ 0^++	TBJE107*010 R □ LC #^++	E	100	10	440	7.5	75	150	6	9	10	0.165	612	551	245	269	242	108
TBJE107*010 J □ # @ 0^++	TBJE107*010 J □ LC #^++	E	100	10	100	7.5	75	150	6	9	10	0.165	1285	1156	514	128	116	51
TBJD157*010 R □ # @ 0^++	TBJD157*010 R □ LC #^++	D	150	10	400	11	110	220	8	10	12	0.150	612	551	245	245	220	98
TBJD157*010 J □ # @ 0^++	TBJD157*010 J □ LC #^++	D	150	10	150	11	110	220	8	10	12	0.150	1000	900	400	150	135	60
TBJE157*010 R □ # @ 0^++	TBJE157*010 R □ LC #^++	E	150	10	400	11	110	220	8	10	12	0.165	642	578	257	257	231	103
TBJE157*010 J □ # @ 0^++	TBJE157*010 J □ LC #^++	E	150	10	150	11	110	220	8	10	12	0.165	1049	944	420	157	142	63
TBJD227*010 R □ # @ 0^++	TBJD227*010 R □ LC #^++	D	220	10	500	17	170	340	8	10	12	0.150	548	493	219	274	246	110
TBJE227*010 R □ # @ 0^++	TBJE227*010 R □ LC #^++	E	220	10	360	17	170	340	8	10	12	0.165	677	609	271	244	219	97
TBJE227*010 J □ # @ 0^++	TBJE227*010 J □ LC #^++	E	220	10	150	17	170	340	8	10	12	0.165	1049	944	420	157	142	63
TBJE337*010 R □ # @ 0^++	TBJE337*010 R □ LC #^++	E	330	10	300	25	250	500	8	10	12	0.165	742	667	297	222	200	89
TBJE337*010 J □ # @ 0^++	TBJE337*010 J □ LC #^++	E	330	10	100	25	250	500	8	10	12	0.165	1285	1156	514	128	116	51
TBJU477*010 R □ # @ 0^++	TBJU477*010 R □ LC #^++	U	470	10	400	35	350	700	30	45	45	0.165	642	578	257	257	231	103
TBJU477*010 J □ # @ 0^++	TBJU477*010 J □ LC #^++	U	470	10	200	35	350	700	30	45	45	0.165	908	817	363	182	163	73
TBJA105*016 R □ # @ 0^++	TBJA105*016 R □ LC #^++	A	1	16	10000	0.3	3	6	6	9	10	0.075	87	78	35	866	779	346
TBJA225*016 R □ # @ 0^++	TBJA225*016 R □ LC #^++	A	2.2	16	4550	0.3	3	6	6	9	10	0.075	128	116	51	584	526	234
TBJA225*016 J □ # @ 0^++	TBJA225*016 J □ LC #^++	A	2.2	16	3500	0.3	3	6	6	9	10	0.075	146	132	59	512	461	205
TBJA335*016 R □ # @ 0^++	TBJA335*016 R □ LC #^++	A	3.3	16	3740	0.4	4	8	6	9	10	0.075	142	127	57	530	477	212
TBJA335*016 J □ # @ 0^++	TBJA335*016 J □ LC #^++	A	3.3	16	3500	0.4	4	8	6	9	10	0.075	146	132	59	512	461	205
TBJB335*016 R □ # @ 0^++	TBJB335*016 R □ LC #^++	B	3.3	16	4500	0.4	4	8	6	9	10	0.085	137	124	55	618	557	247
TBJA475*016 R □ # @ 0^++	TBJA475*016 R □ LC #^++	A	4.7	16	3160	0.56	5.6	11.2	6	9	10	0.075	154	139	62	487	438	195
TBJA475*016 J □ # @ 0^++	TBJA475*016 J □ LC #^++	A	4.7	16	2000	0.56	5.6	11.2	6	9	10	0.075	194	174	77	387	349	155
TBJB475*016 R □ # @ 0^++	TBJB475*016 R □ LC #^++	B	4.7	16	3160	0.56	5.6	11.2	6	9	10	0.085	164	148	66	518	466	207
TBJB475*016 J □ # @ 0^++	TBJB475*016 J □ LC #^++	B	4.7	16	1500	0.56	5.6	11.2	6	9	10	0.085	238	214	95	357	321	143
TBJA685*016 R □ # @ 0^++	TBJA685*016 R □ LC #^++	A	6.8	16	2000	0.82	8.2	16.4	4	6	8	0.075	194	174	77	387	349	155
TBJA685*016 J □ # @ 0^++	TBJA685*016 J □ LC #^++	A	6.8	16	1500	0.82	8.2	16.4	4	6	8	0.075	224	201	89	335	302	134
TBJB685*016 R □ # @ 0^++	TBJB685*016 R □ LC #^++	B	6.8	16	2650	0.82	8.2	16.4	6	9	10	0.085	179	161	72	475	427	190
TBJB685*016 J □ # @ 0^++	TBJB685*016 J □ LC #^++	B	6.8	16	1200	0.82	8.2	16.4	6	9	10	0.085	266	240	106	319	287	128
TBJC685*016 R □ # @ 0^++	TBJC685*016 R □ LC #^++	C	6.8	16	2500	0.82	8.2	16.4	6	9	10	0.110	210	189	84	524	472	210
TBJB106*016 R □ # @ 0^++	TBJB106*016 R □ LC #^++	B	10	16	2200	1.2	12	24	6	9	10	0.085	197	177	79	432	389	173
TBJB106*016 J □ # @ 0^++	TBJB106*016 J □ LC #^++	B	10	16	800	1.2	12	24	6	9	10	0.085	326	293	130	261	235	104
TBJC106*016 R □ # @ 0^++	TBJC106*016 R □ LC #^++	C	10	16	2000	1.2	12	24	6	9	10	0.110	235	211	94	469	422	188
TBJB156*016 R □ # @ 0^++	TBJB156*016 R □ LC #^++	B	15	16	2030	1.8	18	36	6	9	10	0.085	205	184	82	415	374	166
TBJB156*016 J □ # @ 0^++	TBJB156*016 J □ LC #^++	B	15	16	800	1.8	18	36	6	9	10	0.085	326	293	130	261	235	104
TBJB226*016 R □ # @ 0^++	TBJB226*016 R □ LC #^++	B	22	16	1100	2.6	26	52	6	9	10	0.085	278	250	111	306	275	122
TBJB226*016 J □ # @ 0^++	TBJB226*016 J □ LC #^++	B	22	16	600	2.6	26	52	6	9	10	0.085	376	339	151	226	203	90
TBJC226*016 R □ # @ 0^++	TBJC226*016 R □ LC #^++	C	22	16	700	2.6	26	52	6	9	10	0.110	396	357	159	277	250	111
TBJC226*016 J □ # @ 0^++	TBJC226*016 J □ LC #^++	C	22	16	350	2.6	26	52	6	9	10	0.110	561	505	224	196	177	78
TBJD226*016 R □ # @ 0^++	TBJD226*016 R □ LC #^++	D	22	16	1100	2.6	26	52	6	9	10	0.150	369	332	148	406	366	162
TBJC336*016 R □ # @ 0^++	TBJC336*016 R □ LC #^++	C	33	16	590	4	40	80	6	9	10	0.110	432	389	173	255	229	102
TBJC336*016 J □ # @ 0^++	TBJC336*016 J □ LC #^++	C	33	16	300	4	40	80	6	9	10	0.110	606	545	242	182	163	73
TBJC476*016 R □ # @ 0^++	TBJC476*016 R □ LC #^++	C	47	16	540	5.6	56	112	6	9	10	0.110	451	406	181	244	219	97
TBJC476*016 J □ # @ 0^++	TBJC476*016 J □ LC #^++	C	47	16	350	5.6	56	112	6	9	10	0.110	561	505	224	196	177	78
TBJD476*016 R □ # @ 0^++	TBJD476*016 R □ LC #^++	D	47	16	540	5.6	56	112	6	9	10	0.150	527	474	211	285	256	114
TBJD476*016 J □ # @ 0^++	TBJD476*016 J □ LC #^++	D	47	16	200	5.6	56	112	6	9	10	0.150	866	779	346	173	156	69
TBJD686*016 R □ # @ 0^++	TBJD686*016 R □ LC #^++	D	68	16	490	8.2	82	164	6	9	10	0.150	553	498	221	271	244	108
TBJD686*016 J □ # @ 0^++	TBJD686*016 J □ LC #^++	D	68	16	150	8.2	82	164	6	9	10	0.150	1000	900	400	150	135	60
TBJD107*016 R □ # @ 0^++	TBJD107*016 R □ LC #^++	D	100	16	440	12	120	240	6	9	10	0.150	584	525	234	257	231	103
TBJD107*016 J □ # @ 0^++	TBJD107*016 J □ LC #^++	D	100	16	150	12	120	240	6	9	10	0.150	1000	900	400	150	135	60

All technical data relates to an ambient temperature of +25°C. Capacitance and DF are measured at 120Hz, 0.5V RMS with a maximum DC bias of 2.2 volts. DCL is measured at rated voltage after 5 minutes.

NOTE: KYOCERA AVX reserves the right to supply a higher voltage rating or tighter tolerance part in the same case size, to the same reliability standards.

TBJ SERIES

COTS-Plus – Space Level



RATING & PART NUMBER REFERENCE			Parametric Specifications by Rating									Typical RMS Ripple Data by Rating						
			Cap @ 120Hz µF	DC Rated Voltage V	ESR @ 100kHz mOhms	DCL max			DF Max			Power Dissipation W	25°C Ripple mA	85°C Ripple mA	125°C Ripple mA	25°C Ripple mV	85°C Ripple mV	125°C Ripple mV
						+25°C	+85°C	+125°C	+25°C	+85/125 °C	-55°C							
						(µA)	(µA)	(µA)	(%)	(%)	(%)							
P/N	Space Level P/N	Case	µF @ 25°C	V +85°C	mOhms @ +25°C	(µA)	(µA)	(µA)	(%)	(%)	(%)	W	mA (100kHz)	mA (100kHz)	mA (100kHz)	mV (100kHz)	mV (100kHz)	mV (100kHz)
TBJE107*016 R□# @ 0^++	TBJE107*016 R□L C #^++	E	100	16	440	12	120	240	6	9	10	0.165	612	551	245	269	242	108
TBJE107*016 J□# @ 0^++	TBJE107*016 J□L C #^++	E	100	16	150	12	120	240	6	9	10	0.165	1049	944	420	157	142	63
TBJE157*016 R□# @ 0^++	TBJE157*016 R□L C #^++	E	150	16	300	16	160	320	6	9	10	0.165	742	667	297	222	200	89
TBJE157*016 J□# @ 0^++	TBJE157*016 J□L C #^++	E	150	16	150	16	160	320	6	9	10	0.165	1049	944	420	157	142	63
TBJU227*016 R□# @ 0^++	TBJU227*016 R□L C #^++	U	220	16	500	26.4	264	528	12	15	15	0.165	574	517	230	287	259	115
TBJU227*016 J□# @ 0^++	TBJU227*016 J□L C #^++	U	220	16	200	26.4	264	528	12	15	15	0.165	908	817	363	182	163	73
TBJU337*016 R□# @ 0^++	TBJU337*016 R□L C #^++	U	330	16	400	39	390	780	30	45	45	0.165	642	578	257	257	231	103
TBJU337*016 J□# @ 0^++	TBJU337*016 J□L C #^++	U	330	16	200	39	390	780	30	45	45	0.165	908	817	363	182	163	73
TBJA105*020 R□# @ 0^++	TBJA105*020 R□L C #^++	A	1	20	6630	0.3	3	6	4	6	8	0.075	106	96	43	705	635	282
TBJA105*020 J□# @ 0^++	TBJA105*020 J□L C #^++	A	1	20	3000	0.3	3	6	4	6	8	0.075	158	142	63	474	427	190
TBJA155*020 R□# @ 0^++	TBJA155*020 R□L C #^++	A	1.5	20	5460	0.3	3	6	6	9	10	0.075	117	105	47	640	576	256
TBJA155*020 J□# @ 0^++	TBJA155*020 J□L C #^++	A	1.5	20	3000	0.3	3	6	6	9	10	0.075	158	142	63	474	427	190
TBJA225*020 R□# @ 0^++	TBJA225*020 R□L C #^++	A	2.2	20	4550	0.33	3.3	6.6	6	9	10	0.075	128	116	51	584	526	234
TBJA225*020 J□# @ 0^++	TBJA225*020 J□L C #^++	A	2.2	20	3000	0.33	3.3	6.6	6	9	10	0.075	158	142	63	474	427	190
TBJA335*020 R□# @ 0^++	TBJA335*020 R□L C #^++	A	3.3	20	3740	0.5	5	10	6	9	10	0.075	142	127	57	530	477	212
TBJA335*020 J□# @ 0^++	TBJA335*020 J□L C #^++	A	3.3	20	2500	0.5	5	10	6	9	10	0.075	173	156	69	433	390	173
TBJB335*020 R□# @ 0^++	TBJB335*020 R□L C #^++	B	3.3	20	3740	0.5	5	10	6	9	10	0.085	151	136	60	564	507	226
TBJB335*020 J□# @ 0^++	TBJB335*020 J□L C #^++	B	3.3	20	1300	0.5	5	10	6	9	10	0.085	256	230	102	332	299	133
TBJA475*020 R□# @ 0^++	TBJA475*020 R□L C #^++	A	4.7	20	2500	0.71	7.1	14.2	5	8	10	0.075	173	156	69	433	390	173
TBJA475*020 J□# @ 0^++	TBJA475*020 J□L C #^++	A	4.7	20	1800	0.71	7.1	14.2	5	8	10	0.075	204	184	82	367	331	147
TBJB475*020 R□# @ 0^++	TBJB475*020 R□L C #^++	B	4.7	20	3160	0.71	7.1	14.2	6	9	10	0.085	164	148	66	518	466	207
TBJB475*020 J□# @ 0^++	TBJB475*020 J□L C #^++	B	4.7	20	1000	0.71	7.1	14.2	6	9	10	0.085	292	262	117	292	262	117
TBJB685*020 R□# @ 0^++	TBJB685*020 R□L C #^++	B	6.8	20	2650	1	10	20	6	9	10	0.085	179	161	72	475	427	190
TBJB685*020 J□# @ 0^++	TBJB685*020 J□L C #^++	B	6.8	20	1000	1	10	20	6	9	10	0.085	292	262	117	292	262	117
TBJC685*020 R□# @ 0^++	TBJC685*020 R□L C #^++	C	6.8	20	2000	1	10	20	6	9	10	0.110	235	211	94	469	422	188
TBJB106*020 R□# @ 0^++	TBJB106*020 R□L C #^++	B	10	20	2200	1.5	15	30	6	9	10	0.085	197	177	79	432	389	173
TBJB106*020 J□# @ 0^++	TBJB106*020 J□L C #^++	B	10	20	1000	1.5	15	30	6	9	10	0.085	292	262	117	292	262	117
TBJC106*020 R□# @ 0^++	TBJC106*020 R□L C #^++	C	10	20	800	1.5	15	30	6	9	10	0.110	371	334	148	297	267	119
TBJC106*020 J□# @ 0^++	TBJC106*020 J□L C #^++	C	10	20	500	1.5	15	30	6	9	10	0.110	469	422	188	235	211	94
TBJB156*020 R□# @ 0^++	TBJB156*020 R□L C #^++	B	15	20	1400	2.3	23	46	6	9	10	0.085	246	222	99	345	310	138
TBJB156*020 J□# @ 0^++	TBJB156*020 J□L C #^++	B	15	20	500	2.3	23	46	6	9	10	0.085	412	371	165	206	186	82
TBJC156*020 R□# @ 0^++	TBJC156*020 R□L C #^++	C	15	20	720	2.3	23	46	6	9	10	0.110	391	352	156	281	253	113
TBJC156*020 J□# @ 0^++	TBJC156*020 J□L C #^++	C	15	20	400	2.3	23	46	6	9	10	0.110	524	472	210	210	189	84
TBJD156*020 R□# @ 0^++	TBJD156*020 R□L C #^++	D	15	20	1100	2.3	23	46	6	9	10	0.150	369	332	148	406	366	162
TBJC226*020 R□# @ 0^++	TBJC226*020 R□L C #^++	C	22	20	650	3.3	33	66	6	9	10	0.110	411	370	165	267	241	107
TBJC226*020 J□# @ 0^++	TBJC226*020 J□L C #^++	C	22	20	400	3.3	33	66	6	9	10	0.110	524	472	210	210	189	84
TBJD226*020 R□# @ 0^++	TBJD226*020 R□L C #^++	D	22	20	650	3.3	33	66	6	9	10	0.150	480	432	192	312	281	125
TBJD226*020 J□# @ 0^++	TBJD226*020 J□L C #^++	D	22	20	150	3.3	33	66	6	9	10	0.150	1000	900	400	150	135	60
TBJC336*020 R□# @ 0^++	TBJC336*020 R□L C #^++	C	33	20	590	5	50	100	6	9	10	0.110	432	389	173	255	229	102
TBJC336*020 J□# @ 0^++	TBJC336*020 J□L C #^++	C	33	20	300	5	50	100	6	9	10	0.110	606	545	242	182	163	73
TBJD336*020 R□# @ 0^++	TBJD336*020 R□L C #^++	D	33	20	590	5	50	100	6	9	10	0.150	504	454	202	297	268	119
TBJD336*020 J□# @ 0^++	TBJD336*020 J□L C #^++	D	33	20	250	5	50	100	6	9	10	0.150	775	697	310	194	174	77
TBJD476*020 R□# @ 0^++	TBJD476*020 R□L C #^++	D	47	20	540	7.1	71	142	6	9	10	0.150	527	474	211	285	256	114
TBJD476*020 J□# @ 0^++	TBJD476*020 J□L C #^++	D	47	20	200	7.1	71	142	6	9	10	0.150	866	779	346	173	156	69
TBJD686*020 R□# @ 0^++	TBJD686*020 R□L C #^++	D	68	20	490	10	100	200	6	9	10	0.150	553	498	221	271	244	108
TBJD686*020 J□# @ 0^++	TBJD686*020 J□L C #^++	D	68	20	200	10	100	200	6	9	10	0.150	866	779	346	173	156	69
TBJE686*020 R□# @ 0^++	TBJE686*020 R□L C #^++	E	68	20	490	10	100	200	6	9	10	0.165	580	522	232	284	256	114
TBJE686*020 J□# @ 0^++	TBJE686*020 J□L C #^++	E	68	20	120	10	100	200	6	9	10	0.165	1173	1055	469	141	127	56
TBJE107*020 R□# @ 0^++	TBJE107*020 R□L C #^++	E	100	20	300	15	150	300	6	9	10	0.165	742	667	297	222	200	89
TBJE107*020 J□# @ 0^++	TBJE107*020 J□L C #^++	E	100	20	150	15	150	300	6	9	10	0.165	1049	944	420	157	142	63
TBJU157*020 R□# @ 0^++	TBJU157*020 R□L C #^++	U	150	20	500	22	220	440	30	45	45	0.165	574	517	230	287	259	115
TBJU157*020 J□# @ 0^++	TBJU157*020 J□L C #^++	U	150	20	250	22	220	440	30	45	45	0.165	812	731	325	203	183	81
TBJA474*025 R□# @ 0^++	TBJA474*025 R□L C #^++	A	0.47	25	9530	0.3	3	6	4	6	8	0.075	89	80	35	845	761	338
TBJA474*025 J□# @ 0^++	TBJA474*025 J□L C #^++	A	0.47	25	7000	0.3	3	6	4	6	8	0.075	104	93	41	725	652	290
TBJA684*025 R□# @ 0^++	TBJA684*025 R□L C #^++	A	0.68	25	7980	0.3	3	6	4	6	8	0.075	97	87	39	774	696	309
TBJA684*025 J□# @ 0^++	TBJA684*025 J□L C #^++	A	0.68	25	6000	0.3	3	6	4	6	8	0.075	112	101	45	671	604	268
TBJA105*025 R□# @ 0^++	TBJA105*025 R□L C #^++	A	1	25	6630	0.3	3	6	4	6	8	0.075	106	96	43	705	635	282
TBJA105*025 J□# @ 0^++	TBJA105*025 J□L C #^++	A	1	25	3000	0.3	3	6	4	6	8	0.075	158	142	63	474	427	190
TBJA155*025 R□# @ 0^++	TBJA155*025 R□L C #^++	A	1.5	25	5460	0.3	3	6	6	9	10	0.075	117	105	47	640	576	256

All technical data relates to an ambient temperature of +25

TBJ SERIES

COTS-Plus – Space Level



RATING & PART NUMBER REFERENCE			Parametric Specifications by Rating									Typical RMS Ripple Data by Rating						
			Cap @ 120Hz µF @ 25°C	DC Rated Voltage V @ +85°C	ESR @ 100kHz mOhms @ +25°C	DCL max			DF Max			Power Dissipation W	25°C Ripple mA (100kHz)	85°C Ripple mA (100kHz)	125°C Ripple mA (100kHz)	25°C Ripple mV (100kHz)	85°C Ripple mV (100kHz)	125°C Ripple mV (100kHz)
						+25°C	+85°C	+125°C	+25°C	+85/125 °C	-55°C							
P/N	Space Level P/N	Case	(µA)	(µA)	(µA)	(%)	(%)	(%)										
TBJA155*025 J □ # @ 0^++	TBJA155*025 J □ L C #^++	A	1.5	25	3000	0.3	3	6	6	9	10	0.075	158	142	63	474	427	190
TBJB155*025 R □ # @ 0^++	TBJB155*025 R □ L C #^++	B	1.5	25	5000	0.3	3	6	6	9	10	0.085	130	117	52	652	587	261
TBJA225*025 R □ # @ 0^++	TBJA225*025 R □ L C #^++	A	2.2	25	2900	0.41	4.1	8.2	6	9	10	0.075	161	145	64	466	420	187
TBJA225*025 J □ # @ 0^++	TBJA225*025 J □ L C #^++	A	2.2	25	1600	0.41	4.1	8.2	6	9	10	0.075	217	195	87	346	312	139
TBJB225*025 R □ # @ 0^++	TBJB225*025 R □ L C #^++	B	2.2	25	4550	0.41	4.1	8.2	6	9	10	0.085	137	123	55	622	560	249
TBJB225*025 J □ # @ 0^++	TBJB225*025 J □ L C #^++	B	2.2	25	1200	0.41	4.1	8.2	6	9	10	0.085	266	240	106	319	287	128
TBJB335*025 R □ # @ 0^++	TBJB335*025 R □ L C #^++	B	3.3	25	3740	0.62	6.2	12.4	6	9	10	0.085	151	136	60	564	507	226
TBJB335*025 J □ # @ 0^++	TBJB335*025 J □ L C #^++	B	3.3	25	2000	0.62	6.2	12.4	6	9	10	0.085	206	186	82	412	371	165
TBJB475*025 R □ # @ 0^++	TBJB475*025 R □ L C #^++	B	4.7	25	3160	0.88	8.8	17.6	6	9	10	0.085	164	148	66	518	466	207
TBJB475*025 J □ # @ 0^++	TBJB475*025 J □ L C #^++	B	4.7	25	1000	0.88	8.8	17.6	6	9	10	0.085	292	262	117	292	262	117
TBJB685*025 R □ # @ 0^++	TBJB685*025 R □ L C #^++	B	6.8	25	1500	1.3	13	26	6	9	10	0.085	238	214	95	357	321	143
TBJB685*025 J □ # @ 0^++	TBJB685*025 J □ L C #^++	B	6.8	25	1000	1.3	13	26	6	9	10	0.085	292	262	117	292	262	117
TBJC685*025 R □ # @ 0^++	TBJC685*025 R □ L C #^++	C	6.8	25	1070	1.3	13	26	6	9	10	0.110	321	289	128	343	309	137
TBJC685*025 J □ # @ 0^++	TBJC685*025 J □ L C #^++	C	6.8	25	600	1.3	13	26	6	9	10	0.110	428	385	171	257	231	103
TBJC106*025 R □ # @ 0^++	TBJC106*025 R □ L C #^++	C	10	25	800	1.9	19	38	6	9	10	0.110	371	334	148	297	267	119
TBJC106*025 J □ # @ 0^++	TBJC106*025 J □ L C #^++	C	10	25	600	1.9	19	38	6	9	10	0.110	428	385	171	257	231	103
TBJD106*025 R □ # @ 0^++	TBJD106*025 R □ L C #^++	D	10	25	1200	1.9	19	38	6	9	10	0.150	354	318	141	424	382	170
TBJC156*025 R □ # @ 0^++	TBJC156*025 R □ L C #^++	C	15	25	720	2.8	28	56	6	9	10	0.110	391	352	156	281	253	113
TBJC156*025 J □ # @ 0^++	TBJC156*025 J □ L C #^++	C	15	25	500	2.8	28	56	6	9	10	0.110	469	422	188	235	211	94
TBJD156*025 R □ # @ 0^++	TBJD156*025 R □ L C #^++	D	15	25	720	2.8	28	56	6	9	10	0.150	456	411	183	329	296	131
TBJD156*025 J □ # @ 0^++	TBJD156*025 J □ L C #^++	D	15	25	300	2.8	28	56	6	9	10	0.150	707	636	283	212	191	85
TBJD226*025 R □ # @ 0^++	TBJD226*025 R □ L C #^++	D	22	25	650	4.1	41	82	6	9	10	0.150	480	432	192	312	281	125
TBJD226*025 J □ # @ 0^++	TBJD226*025 J □ L C #^++	D	22	25	300	4.1	41	82	6	9	10	0.150	707	636	283	212	191	85
TBJD336*025 R □ # @ 0^++	TBJD336*025 R □ L C #^++	D	33	25	590	6.2	62	124	6	9	10	0.150	504	454	202	297	268	119
TBJD336*025 J □ # @ 0^++	TBJD336*025 J □ L C #^++	D	33	25	400	6.2	62	124	6	9	10	0.150	612	551	245	245	220	98
TBJD476*025 R □ # @ 0^++	TBJD476*025 R □ L C #^++	D	47	25	540	8.8	88	176	6	9	10	0.150	527	474	211	285	256	114
TBJD476*025 J □ # @ 0^++	TBJD476*025 J □ L C #^++	D	47	25	250	8.8	88	176	6	9	10	0.150	775	697	310	194	174	77
TBJE476*025 R □ # @ 0^++	TBJE476*025 R □ L C #^++	E	47	25	540	8.8	88	176	6	9	10	0.165	553	497	221	298	269	119
TBJE476*025 J □ # @ 0^++	TBJE476*025 J □ L C #^++	E	47	25	150	8.8	88	176	6	9	10	0.165	1049	944	420	157	142	63
TBJU686*025 R □ # @ 0^++	TBJU686*025 R □ L C #^++	U	68	25	500	12	120	240	30	45	45	0.165	574	517	230	287	259	115
TBJU107*025 R □ # @ 0^++	TBJU107*025 R □ L C #^++	U	100	25	500	18	180	360	30	45	45	0.165	574	517	230	287	259	115
TBJA104*035 R □ # @ 0^++	TBJA104*035 R □ L C #^++	A	0.1	35	20000	0.3	3	6	4	6	8	0.075	61	55	24	1225	1102	490
TBJA154*035 R □ # @ 0^++	TBJA154*035 R □ L C #^++	A	0.15	35	16470	0.3	3	6	4	6	8	0.075	67	61	27	1111	1000	445
TBJA154*035 J □ # @ 0^++	TBJA154*035 J □ L C #^++	A	0.15	35	6000	0.3	3	6	4	6	8	0.075	112	101	45	671	604	268
TBJA224*035 R □ # @ 0^++	TBJA224*035 R □ L C #^++	A	0.22	35	13710	0.3	3	6	4	6	8	0.075	74	67	30	1014	913	406
TBJA224*035 J □ # @ 0^++	TBJA224*035 J □ L C #^++	A	0.22	35	6000	0.3	3	6	4	6	8	0.075	112	101	45	671	604	268
TBJA334*035 R □ # @ 0^++	TBJA334*035 R □ L C #^++	A	0.33	35	11280	0.3	3	6	4	6	8	0.075	82	73	33	920	828	368
TBJA334*035 J □ # @ 0^++	TBJA334*035 J □ L C #^++	A	0.33	35	6000	0.3	3	6	4	6	8	0.075	112	101	45	671	604	268
TBJA474*035 R □ # @ 0^++	TBJA474*035 R □ L C #^++	A	0.47	35	9530	0.3	3	6	4	6	8	0.075	89	80	35	845	761	338
TBJA474*035 J □ # @ 0^++	TBJA474*035 J □ L C #^++	A	0.47	35	4000	0.3	3	6	4	6	8	0.075	137	123	55	548	493	219
TBJA684*035 R □ # @ 0^++	TBJA684*035 R □ L C #^++	A	0.68	35	7980	0.3	3	6	4	6	8	0.075	97	87	39	774	696	309
TBJA684*035 J □ # @ 0^++	TBJA684*035 J □ L C #^++	A	0.68	35	6000	0.3	3	6	4	6	8	0.075	112	101	45	671	604	268
TBJA105*035 R □ # @ 0^++	TBJA105*035 R □ L C #^++	A	1	35	6630	0.3	3	6	4	6	8	0.075	106	96	43	705	635	282
TBJA105*035 J □ # @ 0^++	TBJA105*035 J □ L C #^++	A	1	35	3000	0.3	3	6	4	6	8	0.075	158	142	63	474	427	190
TBJB105*035 R □ # @ 0^++	TBJB105*035 R □ L C #^++	B	1	35	3400	0.3	3	6	4	6	8	0.085	158	142	63	538	484	215
TBJB105*035 J □ # @ 0^++	TBJB105*035 J □ L C #^++	B	1	35	2000	0.3	3	6	4	6	8	0.085	206	186	82	412	371	165
TBJA155*035 R □ # @ 0^++	TBJA155*035 R □ L C #^++	A	1.5	35	3100	0.39	3.9	7.8	6	9	10	0.075	156	140	62	482	434	193
TBJA155*035 J □ # @ 0^++	TBJA155*035 J □ L C #^++	A	1.5	35	2000	0.39	3.9	7.8	6	9	10	0.075	194	174	77	387	349	155
TBJB155*035 R □ # @ 0^++	TBJB155*035 R □ L C #^++	B	1.5	35	5460	0.39	3.9	7.8	6	9	10	0.085	125	112	50	681	613	272
TBJB155*035 J □ # @ 0^++	TBJB155*035 J □ L C #^++	B	1.5	35	2500	0.39	3.9	7.8	6	9	10	0.085	184	166	74	461	415	184
TBJB225*035 R □ # @ 0^++	TBJB225*035 R □ L C #^++	B	2.2	35	4550	0.58	5.8	11.6	6	9	10	0.085	137	123	55	622	560	249
TBJB225*035 J □ # @ 0^++	TBJB225*035 J □ L C #^++	B	2.2	35	2000	0.58	5.8	11.6	6	9	10	0.085	206	186	82	412	371	165
TBJB335*035 R □ # @ 0^++	TBJB335*035 R □ L C #^++	B	3.3	35	3740	0.87	8.7	17.4	6	9	10	0.085	151	136	60	564	507	226
TBJB335*035 J □ # @ 0^++	TBJB335*035 J □ L C #^++	B	3.3	35	1000	0.87	8.7	17.4	6	9	10	0.085	292	262	117	292	262	117
TBJC335*035 R □ # @ 0^++	TBJC335*035 R □ L C #^++	C	3.3	35	1840	0.87	8.7	17.4	6	9	10	0.110	245	220	98	450	405	180
TBJC335*035 J □ # @ 0^++	TBJC335*035 J □ L C #^++	C	3.3	35	800	0.87	8.7	17.4	6	9	10	0.110	371	334	148	297	267	119
TBJD335*035 R □ # @ 0^++	TBJD335*035 R □ L C #^++	D	3.3	35	2000	0.87	8.7	17.4	6	9	10	0.150	274	246	110	548	493	219
TBJB475*035 R □ # @ 0^++	TBJB475*035 R □ L C #^++	B	4.7	35	2200	1.2	12	24	6	9	10	0.085	197	177	79	432	389	173
TBJB475*035 J □ # @ 0^++	TBJB475*035 J □ L C #^++	B	4.7	35	1500	1.2	12	24	6	9	10	0.085	238	214	95	357	321	143

All technical data relates to an ambient temperature of +25°C. Capacitance and DF are measured at 120Hz, 0.5V RMS with a maximum DC bias of 2.2 volts. DCL is measured at rated voltage after 5 minutes.

NOTE: KYOCERA AVX reserves the right to supply a higher voltage rating or tighter tolerance part in the same case size, to the same reliability standards.



The Important Information/Disclaimer is incorporated in the catalog where these specifications came from or available online at www.kyocera-avx.com/disclaimer/ by reference and should be reviewed in full before placing any order.

TBJ SERIES

COTS-Plus – Space Level



RATING & PART NUMBER REFERENCE			Parametric Specifications by Rating							Typical RMS Ripple Data by Rating								
			Cap @ 120Hz µF @ 25°C	DC Rated Voltage V @ +85°C	ESR @ 100kHz mOhms @ +25°C	DCL max			DF Max			Power Dissipation W	25°C Ripple mA (100kHz)	85°C Ripple mA (100kHz)	125°C Ripple mA (100kHz)	25°C Ripple mV (100kHz)	85°C Ripple mV (100kHz)	125°C Ripple mV (100kHz)
						+25°C (µA)	+85°C (µA)	+125°C (µA)	+25°C (%)	+85/125 °C (%)	-55°C (%)							
P/N	Space Level P/N	Case																
TBJC475 *035 R □ # @ 0 ^ + +	TBJC475*035 R □ L C # ^ + +	C	4.7	35	1410	1.2	12	24	6	9	10	0.110	279	251	112	394	354	158
TBJC475 *035 J □ # @ 0 ^ + +	TBJC475*035 J □ L C # ^ + +	C	4.7	35	600	1.2	12	24	6	9	10	0.110	428	385	171	257	231	103
TBJD475 *035 R □ # @ 0 ^ + +	TBJD475*035 R □ L C # ^ + +	D	4.7	35	1500	1.2	12	24	6	9	10	0.150	316	285	126	474	427	190
TBJC685 *035 R □ # @ 0 ^ + +	TBJC685*035 R □ L C # ^ + +	C	6.8	35	1070	1.8	18	36	6	9	10	0.110	321	289	128	343	309	137
TBJC685 *035 J □ # @ 0 ^ + +	TBJC685*035 J □ L C # ^ + +	C	6.8	35	600	1.8	18	36	6	9	10	0.110	428	385	171	257	231	103
TBJD685 *035 R □ # @ 0 ^ + +	TBJD685*035 R □ L C # ^ + +	D	6.8	35	1300	1.8	18	36	6	9	10	0.150	340	306	136	442	397	177
TBJC106 *035 R □ # @ 0 ^ + +	TBJC106*035 R □ L C # ^ + +	C	10	35	800	2.6	26	52	6	9	10	0.110	371	334	148	297	267	119
TBJC106 *035 J □ # @ 0 ^ + +	TBJC106*035 J □ L C # ^ + +	C	10	35	600	2.6	26	52	6	9	10	0.110	428	385	171	257	231	103
TBJD106 *035 R □ # @ 0 ^ + +	TBJD106*035 R □ L C # ^ + +	D	10	35	800	2.6	26	52	6	9	10	0.150	433	390	173	346	312	139
TBJD106 *035 J □ # @ 0 ^ + +	TBJD106*035 J □ L C # ^ + +	D	10	35	250	2.6	26	52	6	9	10	0.150	775	697	310	194	174	77
TBJD156 *035 R □ # @ 0 ^ + +	TBJD156*035 R □ L C # ^ + +	D	15	35	720	3.9	39	78	6	9	10	0.150	456	411	183	329	296	131
TBJD156 *035 J □ # @ 0 ^ + +	TBJD156*035 J □ L C # ^ + +	D	15	35	225	3.9	39	78	6	9	10	0.150	816	735	327	184	165	73
TBJD226 *035 R □ # @ 0 ^ + +	TBJD226*035 R □ L C # ^ + +	D	22	35	650	5.8	58	116	6	9	10	0.150	480	432	192	312	281	125
TBJD226 *035 J □ # @ 0 ^ + +	TBJD226*035 J □ L C # ^ + +	D	22	35	200	5.8	58	116	6	9	10	0.150	866	779	346	173	156	69
TBJE336 *035 R □ # @ 0 ^ + +	TBJE336 *035 R □ L C # ^ + +	E	33	35	590	8.7	87	174	6	9	10	0.165	529	476	212	312	281	125
TBJE336 *035 J □ # @ 0 ^ + +	TBJE336 *035 J □ L C # ^ + +	E	33	35	250	8.7	87	174	6	9	10	0.165	812	731	325	203	183	81
TBJU476 *035 R □ # @ 0 ^ + +	TBJU476*035 R □ L C # ^ + +	U	47	35	400	12.3	123	246	10	12	12	0.165	642	578	257	257	231	103
TBJU476 *035 J □ # @ 0 ^ + +	TBJU476*035 J □ L C # ^ + +	U	47	35	200	12.3	123	246	10	12	12	0.165	908	817	363	182	163	73
TBJA224 *050 R □ # @ 0 ^ + +	TBJA224 *050 R □ L C # ^ + +	A	0.22	50	7500	0.3	3	6	4	6	8	0.075	100	90	40	750	675	300
TBJA224 *050 J □ # @ 0 ^ + +	TBJA224 *050 J □ L C # ^ + +	A	0.22	50	7000	0.3	3	6	4	6	8	0.075	104	93	41	725	652	290
TBJA334 *050 R □ # @ 0 ^ + +	TBJA334 *050 R □ L C # ^ + +	A	0.33	50	7000	0.3	3	6	4	6	8	0.075	104	93	41	725	652	290
TBJB474 *050 R □ # @ 0 ^ + +	TBJB474*050 R □ L C # ^ + +	B	0.47	50	5000	0.3	3	6	4	6	8	0.085	130	117	52	652	587	261
TBJB684 *050 R □ # @ 0 ^ + +	TBJB684*050 R □ L C # ^ + +	B	0.68	50	4000	0.3	3	6	4	6	8	0.085	146	131	58	583	525	233
TBJB684 *050 J □ # @ 0 ^ + +	TBJB684*050 J □ L C # ^ + +	B	0.68	50	2000	0.3	3	6	4	6	8	0.085	206	186	82	412	371	165
TBJB105 *050 R □ # @ 0 ^ + +	TBJB105*050 R □ L C # ^ + +	B	1	50	3400	0.4	4	8	4	6	8	0.085	158	142	63	538	484	215
TBJB105 *050 J □ # @ 0 ^ + +	TBJB105*050 J □ L C # ^ + +	B	1	50	2000	0.4	4	8	4	6	8	0.085	206	186	82	412	371	165
TBJC105 *050 R □ # @ 0 ^ + +	TBJC105*050 R □ L C # ^ + +	C	1	50	3000	0.4	4	8	4	6	8	0.110	191	172	77	574	517	230
TBJC155 *050 R □ # @ 0 ^ + +	TBJC155*050 R □ L C # ^ + +	C	1.5	50	2500	0.6	6	12	6	9	10	0.110	210	189	84	524	472	210
TBJC155 *050 J □ # @ 0 ^ + +	TBJC155*050 J □ L C # ^ + +	C	1.5	50	1500	0.6	6	12	6	9	10	0.110	271	244	108	406	366	162
TBJC225 *050 R □ # @ 0 ^ + +	TBJC225*050 R □ L C # ^ + +	C	2.2	50	1700	0.8	8	16	6	9	10	0.110	254	229	102	432	389	173
TBJC225 *050 J □ # @ 0 ^ + +	TBJC225*050 J □ L C # ^ + +	C	2.2	50	1000	0.8	8	16	6	9	10	0.110	332	298	133	332	298	133
TBJD225 *050 R □ # @ 0 ^ + +	TBJD225*050 R □ L C # ^ + +	D	2.2	50	2000	0.8	8	16	4.5	7	9	0.150	274	246	110	548	493	219
TBJD225 *050 J □ # @ 0 ^ + +	TBJD225*050 J □ L C # ^ + +	D	2.2	50	1200	0.8	8	16	4.5	7	9	0.150	354	318	141	424	382	170
TBJC335 *050 R □ # @ 0 ^ + +	TBJC335*050 R □ L C # ^ + +	C	3.3	50	1400	1.2	12	24	6	9	10	0.110	280	252	112	392	353	157
TBJC335 *050 J □ # @ 0 ^ + +	TBJC335*050 J □ L C # ^ + +	C	3.3	50	1000	1.2	12	24	6	9	10	0.110	332	298	133	332	298	133
TBJD335 *050 R □ # @ 0 ^ + +	TBJD335*050 R □ L C # ^ + +	D	3.3	50	1100	1.2	12	24	4.5	7	9	0.150	369	332	148	406	366	162
TBJD335 *050 J □ # @ 0 ^ + +	TBJD335*050 J □ L C # ^ + +	D	3.3	50	800	1.2	12	24	4.5	7	9	0.150	433	390	173	346	312	139
TBJD475 *050 R □ # @ 0 ^ + +	TBJD475*050 R □ L C # ^ + +	D	4.7	50	900	1.8	18	36	4.5	7	9	0.150	408	367	163	367	331	147
TBJD475 *050 J □ # @ 0 ^ + +	TBJD475*050 J □ L C # ^ + +	D	4.7	50	600	1.8	18	36	4.5	7	9	0.150	500	450	200	300	270	120
TBJD685 *050 R □ # @ 0 ^ + +	TBJD685*050 R □ L C # ^ + +	D	6.8	50	700	2.6	26	52	4.5	7	9	0.150	463	417	185	324	292	130
TBJE106 *050 R □ # @ 0 ^ + +	TBJE106 *050 R □ L C # ^ + +	E	10	50	700	3.8	38	76	4.5	7	9	0.165	486	437	194	340	306	136
TBJE106 *050 J □ # @ 0 ^ + +	TBJE106 *050 J □ L C # ^ + +	E	10	50	300	3.8	38	76	4.5	7	9	0.165	742	667	297	222	200	89
TBJU156 *050 R □ # @ 0 ^ + +	TBJU156*050 R □ L C # ^ + +	U	15	50	500	5.6	56	112	30	45	45	0.165	574	517	230	287	259	115
TBJU226 *050R □ # @ 0 ^ + +	TBJU226*050 R □ L C # ^ + +	U	22	50	500	8.2	82	164	30	45	45	0.165	574	517	230	287	259	115

All technical data relates to an ambient temperature of +25°C. Capacitance and DF are measured at 120Hz, 0.5V RMS with a maximum DC bias of 2.2 volts. DCL is measured at rated voltage after 5 minutes.

NOTE: KYOCERA AVX reserves the right to supply a higher voltage rating or tighter tolerance part in the same case size, to the same reliability standards.

TBJ SERIES

DLA Dwgs 07016 & 95158

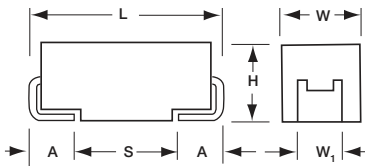
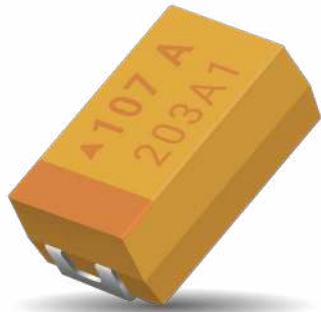

MARKING

(Brown marking on gold body)



Polarity Stripe (+)
Capacitance Code
Rated Voltage
Manufacturer's ID
Lot Number

The DLA 07016 & 95158 families, based on the CWR11 form factor, are high reliability series encompassing the current range of EIA Low ESR ratings. DLA 07016 has the widest range of case sizes, capacitance / voltage ratings, and is offered with Weibull Grade "B", "C", and "D" reliability with all MIL-PRF-55365 surge test options ("A", "B" & "C").

For Space Level applications, SRC9000 qualification is recommend. Please refer to the TBJ COTS-Plus SRC9000 datasheet for part number availability.

There are four termination finishes available:

solder plated, fused solder plated, hot solder dipped and gold plated (these correspond to "H", "K", "C" and "B" termination, respectively, per MIL-PRF-55365).

The molding compound has been selected to meet the requirements of UL94V-0 (Flame Retardancy) and outgassing requirements of ASTM E-595.

For moisture sensitivity levels please refer to the High Reliability Tantalum MSL section located in the back of the High Reliability Tantalum Catalog.

CASE DIMENSIONS: millimeters (inches)

Code	EIA Code	EIA Metric	L±0.20 (0.008)	W+0.20 (0.008) -0.10 (0.004)	H+0.20 (0.008) -0.10 (0.004)	W ₁ ±0.20 (0.008)	A+0.30 (0.012) -0.20 (0.008)	S Min.
A	1206	3216-18	3.20 (0.126)	1.60 (0.063)	1.60 (0.063)	1.20 (0.047)	0.80 (0.031)	1.10 (0.043)
B	1210	3528-21	3.50 (0.138)	2.80 (0.110)	1.90 (0.075)	2.20 (0.087)	0.80 (0.031)	1.40 (0.055)
C	2312	6032-28	6.00 (0.236)	3.20 (0.126)	2.60 (0.102)	2.20 (0.087)	1.30 (0.051)	2.90 (0.114)
D	2917	7343-31	7.30 (0.287)	4.30 (0.169)	2.90 (0.114)	2.40 (0.094)	1.30 (0.051)	4.40 (0.173)
E	2917	7343-43	7.30 (0.287)	4.30 (0.169)	4.10 (0.162)	2.40 (0.094)	1.30 (0.051)	4.40 (0.173)
V	2924	7361-38	7.30 (0.287)	6.10 (0.240)	3.55 (0.140)	3.10 (0.122)	1.30 (0.051)	4.40 (0.173)

W₁ dimension applies to the termination width for A dimensional area only.

CAPACITANCE AND RATED VOLTAGE, V_R (MIL VOLTAGE CODE) RANGE LETTER DENOTES CASE SIZE (ESR LIMITS IN PARENTHESES)

Capacitance		Rated Voltage DC (V _R) at 85°C							
µF	Code	4V (G)	6V (J)	10V (A)	16V (C)	20V (D)	25V (E)	35V (V)	50V (T)
0.15	154								A(15000)
0.22	224								A(18000)
0.47	474							A(12000)	A(9500)/B(9500)
0.68	684						A(10000)	A(8000)	A(7900)
1.0	105						A(8000)	A(7500)	A(6600)/B(7000)
1.5	155					A(6500)	A(3000, 7500)	A(7500)/B(5200)	C(2000)/D(1500)
2.2	225				A(5500)	A(3000)	A(7000)/B(2000)	B(2000)	D(1200)
3.3	335		A(8000)		A(3500, 5000)		B(2000)	B(1000)	D(800)
4.7	475		A(6000)	A(5000)	A(2000)	A(1800, 4000) B(1000)	A(3100) B(700,1500)	B(1500) C(600)/D(450)	D(300)
6.8	685		A(5000)	A(4000)	A(1500)/B(1200)	B(1000)	B(700, 2800) C(700)	C(350)/D(400) E(300)	D(300, 600)
10	106		A(4000)	A(1800, 3000)	A(3000)/B(900)	B(500, 1000) C(700)	C(300, 500)	C(1600)/D(125, 300) E(250)	
15	156		A(3500)	A(1000, 3200) B(600)	B(500, 800)	B(500)/C(450) D(275)	D(275)/E(200)	C(450)/D(100, 300) E(225)	
22	226		A(3000)/B(600)	B(500, 700) C(300)	B(500, 600) C(150, 375)	B(600)/C(400) D(275)	C(275, 400) D(100, 200)/E(225)	D(125, 400) E(125, 300)	
33	336	A(3000)	B(600)	A(700)/B(425, 650) C(500)	C(100, 300) D(250)	C(300) D(100, 200)	D(90, 300) E(100, 175)	D(200, 300) E(300)	
47	476		C(300)	C(200, 350) D(200)	C(110, 350) D(80, 200)	D(100, 200) E(150)	D(175, 250)	E(250)/V(200)	
68	686	A(1500)	B(500)/C(200) D(175)	C(80, 300) D(150)/E(150)	D(150)	D(70, 200) E(150, 200)	V(95)		
100	107	A(1400) B(900)	C(75, 150)	C(75, 200) D(50, 100)/E(100)	D(50, 125) E(125)	V(60)			
150	157		D(125)/E(125)	D(50, 100)/E(100)	D(60, 150)/V(45)				
220	227		D(100, 125) E(100)	D(50, 150) E(50, 100)	V(50)				
330	337		E(50, 150)	D(50, 150) E(50, 100)/V(40)					
470	477		E(50, 200)/V(40)	E(50, 200)/V(40)					
1000	108		E(200)						

NOTE: EIA standards for Low ESR solid tantalum capacitors allow an ESR movement of 1.25 times initial limit post mounting.



The Important Information/Disclaimer is incorporated in the catalog where these specifications came from or available online at www.kyocera-avx.com/disclaimer/ by reference and should be reviewed in full before placing any order.

TDS-HIRELTANT-0009 | Rev 0

TBJ SERIES

DLA Dwgs 07016 & 95158



HOW TO ORDER

DLA DWG P/N:

<p>07016</p> <hr/> <p>DLA DWG 07016</p>	<p>-001</p> <hr/> <p>Dash Number See Rating Tables</p>	<p>K</p> <hr/> <p>Capacitance Tolerance K = ±10% M = ±20%</p>	<p>B</p> <hr/> <p>Reliability Grade B = B Weibull C = C Weibull D = D Weibull</p>	<p>C</p> <hr/> <p>Termination Finish B = Gold Plated (10 microinch minimum) H = Solder Plated (50 microinch minimum) C = Hot Solder Dip (60 microinch minimum) *For Gold Plated Termination Finish, contact the factory for availability.</p>	<p>A</p> <hr/> <p>Surge Test Option A = 10 cycles, +25°C B = 10 cycles, -55°C & +85°C C = 10 cycles, -55°C & +85°C before Weibull Z = None required Per MIL-PRF-55365</p>
<p>LEAD-FREE LEAD-FREE COMPATIBLE COMPONENT</p> <p>RoHS COMPLIANT</p> <p><small>For RoHS compliant products, please select correct termination style.</small></p>					
<p>95158</p> <hr/> <p>DLA DWG 95158</p>	<p>-01</p> <hr/> <p>Dash Number See Rating Tables</p>	<p>K</p> <hr/> <p>Capacitance Tolerance K = ±10% M = ±20%</p>	<p>H</p> <hr/> <p>Termination Finish B = Gold Plated (10 microinch minimum) H = Solder Plated (100 microinch minimum) *For Gold Plated Termination Finish, contact the factory for availability.</p>		
<p>LEAD-FREE LEAD-FREE COMPATIBLE COMPONENT</p> <p>RoHS COMPLIANT</p> <p><small>For RoHS compliant products, please select correct termination style.</small></p>					

TECHNICAL SPECIFICATIONS

Technical Data:	Unless otherwise specified, all technical data relate to an ambient temperature of 25°C									
Capacitance Range:	0.15 µF to 1000 µF									
Capacitance Tolerance:	±10%; ±20%									
Rated Voltage (V _R)	≤ 85°C:	4	6	10	16	20	25	35	50	
Category Voltage (V _C)	≤ 125°C:	2.7	4	7	10	13	17	23	33	
Surge Voltage (V _S)	≤ 85°C:	5.2	8	13	20	26	32	46	65	
Surge Voltage (V _S)	≤ 125°C:	3.4	5	8	12	16	20	28	40	
Temperature Range:	-55°C to +125°C									

TBJ SERIES

DLA Dwgs 07016 & 95158



RATING & PART NUMBER REFERENCE		Parametric Specifications by Rating per DLA 95158 or 07016 where applicable									Typical RMS Ripple Data by Rating						
		Cap @ 120Hz µF @ 25°C	DC Rated Voltage V @ +85°C	ESR @ 100kHz mOhms @ +25°C	DCL max			DF Max			Power Dissipation W	25°C Ripple A (100kHz)	85°C Ripple A (100kHz)	125°C Ripple A (100kHz)	25°C Ripple V (100kHz)	85°C Ripple V (100kHz)	125°C Ripple V (100kHz)
					+25°C	+85°C	+125°C	+25°C	+(85/125)°C	-55°C							
DLA P/N	Case				(µA)	(µA)	(µA)	(%)	(%)	(%)							
07016 001	* @ ^ + A	33	4	3000	1.4	14	17	6	9	9	0.075	0.16	0.14	0.06	0.47	0.43	0.19
07016 002	* @ ^ + A	68	4	1500	2.7	27	32	10	12	14	0.075	0.22	0.20	0.09	0.34	0.30	0.13
07016 003	* @ ^ + A	100	4	1400	4	40	48	30	36	42	0.075	0.23	0.21	0.09	0.32	0.29	0.13
07016 004	* @ ^ + B	100	4	900	4	40	48	8	10	12	0.085	0.31	0.28	0.12	0.28	0.25	0.11
07016 005	* @ ^ + E	1,000	4	200	40	400	480	60	90	90	0.165	0.91	0.82	0.36	0.18	0.16	0.07
07016 006	* @ ^ + A	3.3	6	8000	0.5	5	6	6	9	9	0.075	0.10	0.09	0.04	0.77	0.70	0.31
07016 007	* @ ^ + A	4.7	6	6000	0.5	5	6	6	9	10	0.075	0.11	0.10	0.04	0.67	0.60	0.27
07016 008	* @ ^ + A	6.8	6	5000	0.5	5	6	6	9	10	0.075	0.12	0.11	0.05	0.61	0.55	0.24
07016 009	* @ ^ + A	10	6	4000	0.6	10	11	6	9	10	0.075	0.14	0.12	0.05	0.55	0.49	0.22
07016 010	* @ ^ + A	15	6	3500	0.9	10	11	6	9	10	0.075	0.15	0.13	0.06	0.51	0.46	0.20
07016 011	* @ ^ + A	22	6	3000	1.4	14	17	6	9	10	0.075	0.16	0.14	0.06	0.47	0.43	0.19
07016 012	* @ ^ + B	22	6	600	1.4	14	17	6	9	10	0.085	0.38	0.34	0.15	0.23	0.20	0.09
07016 013	* @ ^ + B	33	6	600	2.1	21	25	6	9	10	0.085	0.38	0.34	0.15	0.23	0.20	0.09
07016 014	* @ ^ + C	47	6	300	3	30	36	6	9	10	0.110	0.61	0.54	0.24	0.18	0.16	0.07
07016 015	* @ ^ + B	68	6	500	4.3	43	51	8	10	12	0.085	0.41	0.37	0.16	0.21	0.19	0.08
07016 016	* @ ^ + C	68	6	200	4.3	43	51	6	9	10	0.110	0.74	0.67	0.30	0.15	0.13	0.06
95158 01	* ^ D	68	6	175	3.3	19.8	33	4	6	6	0.150	0.93	0.83	0.37	0.16	0.15	0.06
07016 017	* @ ^ + C	100	6	150	6.3	63	76	6	9	10	0.110	0.86	0.77	0.34	0.13	0.12	0.05
07016 018	* @ ^ + C	100	6	75	6.3	63	76	6	9	10	0.110	1.21	1.09	0.48	0.09	0.08	0.04
07016 019	* @ ^ + D	150	6	125	9.5	95	113	6	9	10	0.150	1.10	0.99	0.44	0.14	0.12	0.05
95158 02	* ^ E	150	6	125	7.2	43.2	72	6	8	8	0.165	1.15	1.03	0.46	0.14	0.13	0.06
07016 020	* @ ^ + D	220	6	125	13.9	139	166	8	10	12	0.150	1.10	0.99	0.44	0.14	0.12	0.05
95158 25	* ^ D	220	6	100	13.2	132	165	8	10	12	0.150	1.22	1.10	0.49	0.12	0.11	0.05
95158 03	* ^ E	220	6	100	13.2	132	165	8	12	12	0.165	1.28	1.16	0.51	0.13	0.12	0.05
07016 021	* @ ^ + E	330	6	150	20.8	208	249	8	10	12	0.165	1.05	0.94	0.42	0.16	0.14	0.06
07016 022	* @ ^ + E	330	6	50	20.8	208	249	8	10	12	0.165	1.82	1.63	0.73	0.09	0.08	0.04
07016 023	M @ ^ + E	470	6	200	29.6	296	355	10	12	14	0.165	0.91	0.82	0.36	0.18	0.16	0.07
07016 024	M @ ^ + E	470	6	50	29.6	296	355	10	12	14	0.165	1.82	1.63	0.73	0.09	0.08	0.04
07016 025	* @ ^ + V	470	6	40	29.6	296	355	10	12	12	0.250	2.50	2.25	1.00	0.10	0.09	0.04
07016 026	* @ ^ + A	4.7	10	5000	0.5	5	6	6	9	10	0.075	0.12	0.11	0.05	0.61	0.55	0.24
07016 027	* @ ^ + A	6.8	10	4000	0.7	7	8	6	9	10	0.075	0.14	0.12	0.05	0.55	0.49	0.22
07016 028	* @ ^ + A	10	10	3000	1	10	12	6	9	10	0.075	0.16	0.14	0.06	0.47	0.43	0.19
07016 029	* @ ^ + A	10	10	1800	1	10	12	6	9	10	0.075	0.20	0.18	0.08	0.37	0.33	0.15
07016 030	* @ ^ + A	15	10	3200	1.6	16	19	6	9	10	0.075	0.15	0.14	0.06	0.49	0.44	0.20
07016 031	* @ ^ + A	15	10	1000	1.6	16	19	6	9	10	0.075	0.27	0.25	0.11	0.27	0.25	0.11
07016 032	* @ ^ + B	15	10	600	1.6	16	19	6	9	10	0.085	0.38	0.34	0.15	0.23	0.20	0.09
07016 033	* @ ^ + B	22	10	700	2.2	22	26	6	9	10	0.085	0.35	0.31	0.14	0.24	0.22	0.10
07016 034	* @ ^ + B	22	10	500	2.2	22	26	6	9	10	0.085	0.41	0.37	0.16	0.21	0.19	0.08
07016 035	* @ ^ + C	22	10	300	2.2	22	26	6	9	10	0.110	0.61	0.54	0.24	0.18	0.16	0.07
07016 036	* @ ^ + A	33	10	700	3.3	33	40	8	10	12	0.075	0.33	0.29	0.13	0.23	0.21	0.09
07016 037	* @ ^ + B	33	10	650	3.3	33	40	6	9	10	0.085	0.36	0.33	0.14	0.24	0.21	0.09
07016 038	* @ ^ + B	33	10	425	3.3	33	40	6	9	10	0.085	0.45	0.40	0.18	0.19	0.17	0.08
07016 039	* @ ^ + C	33	10	500	3.3	33	40	6	9	10	0.110	0.47	0.42	0.19	0.23	0.21	0.09
07016 040	* @ ^ + C	47	10	350	4.7	47	56	6	9	10	0.110	0.56	0.50	0.22	0.20	0.18	0.08
07016 041	* @ ^ + C	47	10	200	4.7	47	56	6	9	10	0.110	0.74	0.67	0.30	0.15	0.13	0.06
95158-04	* ^ D	47	10	200	3.8	22.8	38	4	6	6	0.150	0.87	0.78	0.35	0.17	0.16	0.07
07016 042	* @ ^ + C	68	10	300	6.8	68	82	8	10	12	0.110	0.61	0.54	0.24	0.18	0.16	0.07
07016 043	* @ ^ + C	68	10	80	6.8	68	82	8	10	12	0.110	1.17	1.06	0.47	0.09	0.08	0.04
07016 044	* @ ^ + D	68	10	150	6.8	68	82	6	9	10	0.150	1.00	0.90	0.40	0.15	0.14	0.06
95158 05	* ^ E	68	10	150	5.4	32.4	54	4	6	6	0.165	1.05	0.94	0.42	0.16	0.14	0.06

All technical data relates to an ambient temperature of +25°C. Capacitance and DF are measured at 120Hz, 0.5V RMS with a maximum DC bias of 2.2 volts. DCL is measured at rated voltage after 5 minutes.

NOTE: KYOCERA AVX reserves the right to supply a higher voltage rating or tighter tolerance part in the same case size, to the same reliability standards.



The Important Information/Disclaimer is incorporated in the catalog where these specifications came from or available online at www.kyocera-avx.com/disclaimer/ by reference and should be reviewed in full before placing any order.

TBJ SERIES

DLA Dwgs 07016 & 95158



RATING & PART NUMBER REFERENCE			Parametric Specifications by Rating per DLA 95158 or 07016 where applicable									Typical RMS Ripple Data by Rating						
			Cap @ 120Hz @ 25°C	DC Rated Voltage @ +85°C	ESR @ 100kHz mOhms @ +25°C	DCL max			DF Max			Power Dissipation W	25°C Ripple A (100kHz)	85°C Ripple A (100kHz)	125°C Ripple A (100kHz)	25°C Ripple V (100kHz)	85°C Ripple V (100kHz)	125°C Ripple V (100kHz)
						+25°C	+85°C	+125°C	+25°C	+(85/125)°C	-55°C							
DLA P/N	Case	µF	V	mOhms	(µA)	(µA)	(µA)	(%)	(%)	(%)								
07016 045	* @ ^ +	C	100	10	200	10	100	120	8	10	12	0.110	0.74	0.67	0.30	0.15	0.13	0.06
07016 046	* @ ^ +	C	100	10	75	10	100	120	8	10	12	0.110	1.21	1.09	0.48	0.09	0.08	0.04
95158 06	* ^	D	100	10	100	10	100	125	8	12	12	0.150	1.22	1.10	0.49	0.12	0.11	0.05
07016 047	* @ ^ +	D	100	10	50	10	100	120	6	9	10	0.150	1.73	1.56	0.69	0.09	0.08	0.03
95158 07	* ^	E	100	10	100	8	48	80	6	8	8	0.165	1.28	1.16	0.51	0.13	0.12	0.05
95158 26	* ^	D	150	10	100	15	150	187.5	8	10	12	0.150	1.22	1.10	0.49	0.12	0.11	0.05
07016 048	* @ ^ +	D	150	10	50	15	150	180	8	10	12	0.150	1.73	1.56	0.69	0.09	0.08	0.03
95158 08	* ^	E	150	10	100	15	150	187.5	8	12	12	0.165	1.28	1.16	0.51	0.13	0.12	0.05
07016 049	* @ ^ +	D	220	10	150	22	220	264	8	10	12	0.150	1.00	0.90	0.40	0.15	0.14	0.06
07016 050	M @ ^ +	D	220	10	50	15	150	180	8	10	12	0.150	1.73	1.56	0.69	0.09	0.08	0.03
95158 28	* ^	E	220	10	100	15	150	187.5	8	10	12	0.165	1.28	1.16	0.51	0.13	0.12	0.05
07016 051	* @ ^ +	E	220	10	50	22	220	264	8	10	12	0.165	1.82	1.63	0.73	0.09	0.08	0.04
07016 052	M @ ^ +	D	330	10	150	33	330	396	8	10	12	0.150	1.00	0.90	0.40	0.15	0.14	0.06
07016 053	M @ ^ +	D	330	10	50	33	330	396	8	10	12	0.150	1.73	1.56	0.69	0.09	0.08	0.03
07016 054	* @ ^ +	E	330	10	100	33	330	396	8	10	12	0.165	1.28	1.16	0.51	0.13	0.12	0.05
07016 055	* @ ^ +	E	330	10	50	33	330	396	8	10	12	0.165	1.82	1.63	0.73	0.09	0.08	0.04
07016 056	* @ ^ +	V	330	10	40	33	330	396	8	10	12	0.250	2.50	2.25	1.00	0.10	0.09	0.04
07016 057	M @ ^ +	E	470	10	200	47	470	564	10	12	14	0.165	0.91	0.82	0.36	0.18	0.16	0.07
07016 058	M @ ^ +	E	470	10	50	47	470	564	10	12	14	0.165	1.82	1.63	0.73	0.09	0.08	0.04
07016 059	* @ ^ +	V	470	10	40	47	470	564	10	12	14	0.250	2.50	2.25	1.00	0.10	0.09	0.04
07016 060	* @ ^ +	A	2.2	16	5500	0.5	5	6	6	9	10	0.075	0.12	0.11	0.05	0.64	0.58	0.26
07016 061	* @ ^ +	A	3.3	16	5000	0.5	5	6	6	9	10	0.075	0.12	0.11	0.05	0.61	0.55	0.24
07016 062	* @ ^ +	A	3.3	16	3500	0.5	5	6	6	9	10	0.075	0.15	0.13	0.06	0.51	0.46	0.20
07016 063	* @ ^ +	A	4.7	16	2000	0.8	8	10	6	9	10	0.075	0.19	0.17	0.08	0.39	0.35	0.15
07016 064	* @ ^ +	A	6.8	16	1500	1.1	11	13	6	9	10	0.075	0.22	0.20	0.09	0.34	0.30	0.13
07016 065	* @ ^ +	B	6.8	16	1200	1.1	11	13	6	9	10	0.085	0.27	0.24	0.11	0.32	0.29	0.13
07016 066	* @ ^ +	A	10	16	3000	1.6	16	19	6	9	10	0.075	0.16	0.14	0.06	0.47	0.43	0.19
07016 067	* @ ^ +	B	10	16	900	1.6	16	19	6	9	10	0.085	0.32	0.29	0.13	0.26	0.23	0.10
07016 068	* @ ^ +	B	15	16	800	2.4	24	29	6	9	10	0.085	0.33	0.29	0.13	0.26	0.23	0.10
07016 069	* @ ^ +	B	15	16	500	2.4	24	29	6	9	10	0.085	0.41	0.37	0.16	0.21	0.19	0.08
07016 070	* @ ^ +	B	22	16	600	3.6	36	43	6	9	10	0.085	0.38	0.34	0.15	0.23	0.20	0.09
07016 071	* @ ^ +	C	22	16	375	3.6	36	43	6	9	10	0.110	0.54	0.49	0.22	0.20	0.18	0.08
07016 072	* @ ^ +	C	22	16	150	3.6	36	43	6	9	10	0.110	0.86	0.77	0.34	0.13	0.12	0.05
07016 073	* @ ^ +	B	22	16	500	3.6	36	43	6	9	10	0.085	0.41	0.37	0.16	0.21	0.19	0.08
07016 074	* @ ^ +	C	33	16	300	5.3	53	64	6	9	10	0.110	0.61	0.54	0.24	0.18	0.16	0.07
07016 075	* @ ^ +	C	33	16	100	5.3	53	64	6	9	10	0.110	1.05	0.94	0.42	0.10	0.09	0.04
95158 09	* ^	D	33	16	250	4.2	25.2	42	4	6	6	0.150	0.77	0.70	0.31	0.19	0.17	0.08
07016 076	* @ ^ +	C	47	16	350	7.6	76	91	6	9	10	0.110	0.56	0.50	0.22	0.20	0.18	0.08
07016 077	* @ ^ +	C	47	16	110	7.6	76	91	6	9	10	0.110	1.00	0.90	0.40	0.11	0.10	0.04
07016 078	* @ ^ +	D	47	16	80	7.6	76	91	6	9	10	0.150	1.37	1.23	0.55	0.11	0.10	0.04
95158 10	* ^	D	47	16	200	7.5	75	94	6	9	9	0.150	0.87	0.78	0.35	0.17	0.16	0.07
07016 079	* @ ^ +	D	68	16	150	10.9	109	131	6	9	10	0.150	1.00	0.90	0.40	0.15	0.14	0.06
07016 080	* @ ^ +	D	100	16	125	16	160	192	6	9	10	0.150	1.10	0.99	0.44	0.14	0.12	0.05
07016 081	* @ ^ +	D	100	16	50	16	160	192	6	9	10	0.150	1.73	1.56	0.69	0.09	0.08	0.03
95158 11	* ^	E	100	16	125	16	160	200	8	12	12	0.165	1.15	1.03	0.46	0.14	0.13	0.06
07016 082	M @ ^ +	D	150	16	150	24	240	288	6	9	10	0.150	1.00	0.90	0.40	0.15	0.14	0.06
07016 083	M @ ^ +	D	150	16	60	24	240	288	6	9	10	0.150	1.58	1.42	0.63	0.09	0.09	0.04
07016 084	* @ ^ +	V	150	16	45	24	480	288	6	8	10	0.250	2.36	2.12	0.94	0.11	0.10	0.04
07016 085	* @ ^ +	V	220	16	50	35.2	352	422	8	10	12	0.250	2.24	2.01	0.89	0.11	0.10	0.04
07016 086	* @ ^ +	A	1.5	20	6500	0.5	5	6	6	8	10	0.075	0.11	0.10	0.04	0.70	0.63	0.28

All technical data relates to an ambient temperature of +25°C. Capacitance and DF are measured at 120Hz, 0.5V RMS with a maximum DC bias of 2.2 volts. DCL is measured at rated voltage after 5 minutes.

NOTE: KYOCERA AVX reserves the right to supply a higher voltage rating or tighter tolerance part in the same case size, to the same reliability standards.

TBJ SERIES

DLA Dwgs 07016 & 95158



RATING & PART NUMBER REFERENCE		Parametric Specifications by Rating per DLA 95158 or 07016 where applicable									Typical RMS Ripple Data by Rating							
		Cap @ 120Hz @ 25°C µF	DC Rated Voltage @ +85°C V	ESR @ 100kHz mOhms @ +25°C	DCL max			DF Max			Power Dissipation W	25°C Ripple A (100kHz)	85°C Ripple A (100kHz)	125°C Ripple A (100kHz)	25°C Ripple V (100kHz)	85°C Ripple V (100kHz)	125°C Ripple V (100kHz)	
					+25°C (µA)	+85°C (µA)	+125°C (µA)	+25°C (%)	+85/125°C (%)	-55°C (%)								
DLA P/N	Case																	
07016 087	* @ ^ +	A	2.2	20	3000	0.5	5	6	6	8	10	0.075	0.16	0.14	0.06	0.47	0.43	0.19
07016 088	* @ ^ +	A	4.7	20	4000	1	10	12	6	8	10	0.075	0.14	0.12	0.05	0.55	0.49	0.22
07016 089	* @ ^ +	A	4.7	20	1800	1	10	12	6	8	10	0.075	0.20	0.18	0.08	0.37	0.33	0.15
07016 090	* @ ^ +	B	4.7	20	1000	2	20	24	6	8	10	0.085	0.29	0.26	0.12	0.29	0.26	0.12
07016 091	* @ ^ +	B	6.8	20	1000	1.4	14	17	6	8	10	0.085	0.29	0.26	0.12	0.29	0.26	0.12
07016 092	* @ ^ +	B	10	20	1000	0.7	7	8	6	8	10	0.085	0.29	0.26	0.12	0.29	0.26	0.12
07016 093	* @ ^ +	B	10	20	500	0.7	7	8	6	8	10	0.085	0.41	0.37	0.16	0.21	0.19	0.08
07016 094	* @ ^ +	C	10	20	700	1.4	14	17	6	8	10	0.110	0.40	0.36	0.16	0.28	0.25	0.11
07016 095	* @ ^ +	B	15	20	500	3	30	36	6	8	10	0.085	0.41	0.37	0.16	0.21	0.19	0.08
07016 096	* @ ^ +	C	15	20	450	3	30	36	6	8	10	0.110	0.49	0.44	0.20	0.22	0.20	0.09
95158 12	* ^	D	15	20	275	2.4	14.4	24	4	6	6	0.150	0.74	0.66	0.30	0.20	0.18	0.08
07016 097	* @ ^ +	B	22	20	600	4.4	44	53	6	8	10	0.085	0.38	0.34	0.15	0.23	0.20	0.09
07016 098	* @ ^ +	C	22	20	400	4.4	44	53	6	8	10	0.110	0.52	0.47	0.21	0.21	0.19	0.08
95158 13	* ^	D	22	20	275	3.5	21	35	4	6	6	0.150	0.74	0.66	0.30	0.20	0.18	0.08
07016 099	* @ ^ +	C	33	20	300	6.6	66	79	6	8	10	0.110	0.61	0.54	0.24	0.18	0.16	0.07
07016 100	* @ ^ +	D	33	20	200	6.6	66	79	6	8	10	0.150	0.87	0.78	0.35	0.17	0.16	0.07
07016 101	* @ ^ +	D	33	20	100	6.6	66	79	6	8	10	0.150	1.22	1.10	0.49	0.12	0.11	0.05
07016 102	* @ ^ +	D	47	20	200	9.4	94	113	6	8	10	0.150	0.87	0.78	0.35	0.17	0.16	0.07
07016 103	* @ ^ +	D	47	20	100	9.4	94	113	6	8	10	0.150	1.22	1.10	0.49	0.12	0.11	0.05
95158 14	* ^	E	47	20	150	7.5	45	75	4	6	6	0.165	1.05	0.94	0.42	0.16	0.14	0.06
07016 104	* @ ^ +	D	68	20	200	13.6	136	163	6	8	10	0.150	0.87	0.78	0.35	0.17	0.16	0.07
07016 105	* @ ^ +	D	68	20	70	13.6	136	163	6	8	10	0.150	1.46	1.32	0.59	0.10	0.09	0.04
07016 106	* @ ^ +	E	68	20	200	13.6	136	163	6	8	10	0.165	0.91	0.82	0.36	0.18	0.16	0.07
95158 15	* ^	E	68	20	150	13.6	136	170	6	8	9	0.165	1.05	0.94	0.42	0.16	0.14	0.06
07016 107	* @ ^ +	V	100	20	60	20	200	240	8	10	12	0.250	2.04	1.84	0.82	0.12	0.11	0.05
07016 108	M @ ^ +	A	0.7	25	10000	0.5	5	6	4	6	8	0.075	0.09	0.08	0.03	0.87	0.78	0.35
07016 109	* @ ^ +	A	1.0	25	8000	0.5	5	6	4	6	8	0.075	0.10	0.09	0.04	0.77	0.70	0.31
07016 110	* @ ^ +	A	1.5	25	7500	0.5	5	6	6	8	10	0.075	0.10	0.09	0.04	0.75	0.68	0.30
07016 111	* @ ^ +	A	1.5	25	3000	0.5	5	6	6	8	10	0.075	0.16	0.14	0.06	0.47	0.43	0.19
07016 112	* @ ^ +	A	2.2	25	7000	0.5	5	6	6	8	10	0.075	0.10	0.09	0.04	0.72	0.65	0.29
07016 113	* @ ^ +	B	2.2	25	2000	0.5	5	6	6	8	10	0.085	0.21	0.19	0.08	0.41	0.37	0.16
07016 114	* @ ^ +	B	3.3	25	2000	0.5	5	6	6	8	10	0.085	0.21	0.19	0.08	0.41	0.37	0.16
07016 115	* @ ^ +	A	4.7	25	3100	1.2	12	14	6	9	10	0.075	0.16	0.14	0.06	0.48	0.43	0.19
07016 116	* @ ^ +	B	4.7	25	1500	1.2	12	14	6	8	10	0.085	0.24	0.21	0.10	0.36	0.32	0.14
07016 117	* @ ^ +	B	4.7	25	700	1.2	12	14	6	8	10	0.085	0.35	0.31	0.14	0.24	0.22	0.10
07016 118	* @ ^ +	B	6.8	25	2800	1.7	17	20	6	8	10	0.085	0.17	0.16	0.07	0.49	0.44	0.20
07016 119	* @ ^ +	B	6.8	25	700	1.7	17	20	6	8	10	0.085	0.35	0.31	0.14	0.24	0.22	0.10
07016 120	* @ ^ +	C	6.8	25	700	1.7	17	20	6	8	10	0.110	0.40	0.36	0.16	0.28	0.25	0.11
07016 121	* @ ^ +	C	10	25	500	2.5	25	30	6	8	10	0.110	0.47	0.42	0.19	0.23	0.21	0.09
07016 122	* @ ^ +	C	10	25	300	2.5	25	30	6	8	10	0.110	0.61	0.54	0.24	0.18	0.16	0.07
95158 16	* ^	D	15	25	275	3.8	38	46.9	6	9	9	0.150	0.74	0.66	0.30	0.20	0.18	0.08
95158 17	* ^	E	15	25	200	3	18	30	4	6	6	0.165	0.91	0.82	0.36	0.18	0.16	0.07
07016 123	* @ ^ +	C	22	25	400	5.5	55	66	6	8	10	0.110	0.52	0.47	0.21	0.21	0.19	0.08
07016 124	* @ ^ +	C	22	25	275	5.5	55	66	6	8	10	0.110	0.63	0.57	0.25	0.17	0.16	0.07
07016 125	* @ ^ +	D	22	25	200	5.5	55	66	6	8	10	0.150	0.87	0.78	0.35	0.17	0.16	0.07
07016 126	* @ ^ +	D	22	25	100	5.5	55	66	6	8	10	0.150	1.22	1.10	0.49	0.12	0.11	0.05
95158 18	* ^	E	22	25	225	4.4	26.4	44	4	6	6	0.165	0.86	0.77	0.34	0.19	0.17	0.08
07016 127	* @ ^ +	D	33	25	300	8.3	83	100	6	8	10	0.150	0.71	0.64	0.28	0.21	0.19	0.08
07016 128	* @ ^ +	D	33	25	90	8.3	83	100	6	8	10	0.150	1.22	1.10	0.49	0.12	0.11	0.05
95158 19	* ^	E	33	25	175	6.6	39.6	66	4	6	6	0.165	0.97	0.87	0.39	0.17	0.15	0.07

All technical data relates to an ambient temperature of +25°C. Capacitance and DF are measured at 120Hz, 0.5V RMS with a maximum DC bias of 2.2 volts. DCL is measured at rated voltage after 5 minutes.

NOTE: KYOCERA AVX reserves the right to supply a higher voltage rating or tighter tolerance part in the same case size, to the same reliability standards.



The Important Information/Disclaimer is incorporated in the catalog where these specifications came from or available online at www.kyocera-avx.com/disclaimer/ by reference and should be reviewed in full before placing any order.

TBJ SERIES

DLA Dwgs 07016 & 95158



RATING & PART NUMBER REFERENCE		Parametric Specifications by Rating per DLA 95158 or 07016 where applicable									Typical RMS Ripple Data by Rating						
		Cap @ 120Hz µF @ 25°C	DC Rated Voltage V @ +85°C	ESR @ 100kHz mOhms @ +25°C	DCL max			DF Max			Power Dissipation W	25°C Ripple A (100kHz)	85°C Ripple A (100kHz)	125°C Ripple A (100kHz)	25°C Ripple V (100kHz)	85°C Ripple V (100kHz)	125°C Ripple V (100kHz)
					+25°C	+85°C	+125°C	+25°C	+(85/125)°C	-55°C							
DLA P/N	Case				(µA)	(µA)	(µA)	(%)	(%)	(%)							
07016 129 * @ ^ +	E	33	25	100	8.3	83	100	6	8	10	0.165	1.35	1.22	0.54	0.12	0.11	0.05
07016 130 M @ ^ +	D	47	25	250	11.8	118	142	6	8	10	0.150	0.77	0.70	0.31	0.19	0.17	0.08
07016 131 M @ ^ +	D	47	25	175	11.8	118	142	6	8	10	0.150	0.93	0.83	0.37	0.16	0.15	0.06
07016 132 * @ ^ +	V	68	25	95	17	170	204	8	10	12	0.250	1.62	1.46	0.65	0.15	0.14	0.06
07016 133 M @ ^ +	A	0.47	35	12000	0.5	5	6	4	6	8	0.075	0.08	0.07	0.03	0.95	0.85	0.38
07016 134 M @ ^ +	A	0.68	35	8000	0.5	5	6	4	6	8	0.075	0.10	0.09	0.04	0.77	0.70	0.31
07016 135 * @ ^ +	A	1.0	35	7500	0.5	5	6	4	6	6	0.075	0.10	0.09	0.04	0.75	0.68	0.30
07016 136 * @ ^ +	A	1.5	35	7500	0.5	5	6	6	8	9	0.075	0.10	0.09	0.04	0.75	0.68	0.30
07016 137 * @ ^ +	B	1.5	35	5200	0.5	5	6	6	8	9	0.085	0.13	0.12	0.05	0.66	0.60	0.27
07016 138 * @ ^ +	B	2.2	35	2000	0.8	8	10	6	8	9	0.085	0.21	0.19	0.08	0.41	0.37	0.16
07016 139 * @ ^ +	B	3.3	35	1000	1.2	12	14	6	8	9	0.085	0.29	0.26	0.12	0.29	0.26	0.12
07016 140 * @ ^ +	B	4.7	35	1500	1.6	16	19	6	8	9	0.085	0.24	0.21	0.10	0.36	0.32	0.14
95158 29 * @ ^ +	C	4.7	35	600	1.7	10.2	17	6	8	9	0.110	0.43	0.39	0.17	0.26	0.23	0.10
07016 141 * @ ^ +	D	4.7	35	450	1.6	16	20	6	8	9	0.110	0.49	0.44	0.20	0.22	0.20	0.09
07016 142 * @ ^ +	C	6.8	35	350	2.4	24	29	6	9	9	0.150	0.65	0.59	0.26	0.23	0.21	0.09
07016 143 * @ ^ +	D	6.8	35	400	2.4	24	29	6	9	9	0.165	0.64	0.58	0.26	0.26	0.23	0.10
95158 20 * @ ^ +	E	6.8	35	300	1.9	11.4	19	4	6	6	0.165	0.74	0.67	0.30	0.22	0.20	0.09
07016 144 * @ ^ +	C	10	35	1600	3.5	35	42	6	9	9	0.110	0.26	0.24	0.10	0.42	0.38	0.17
95158 27 * @ ^ +	D	10	35	300	3.5	35	42	4	6	6	0.150	0.71	0.64	0.28	0.21	0.19	0.08
07016 145 * @ ^ +	D	10	35	125	3.5	35	42	6	9	9	0.150	1.10	0.99	0.44	0.14	0.12	0.05
95158 21 * @ ^ +	E	10	35	250	2.8	16.8	28	4	6	6	0.165	0.81	0.73	0.32	0.20	0.18	0.08
07016 146 * @ ^ +	C	15	35	450	5.3	53	64	6	9	9	0.110	0.49	0.44	0.20	0.22	0.20	0.09
07016 147 * @ ^ +	D	15	35	300	5.3	53	64	6	9	9	0.150	0.71	0.64	0.28	0.21	0.19	0.08
07016 148 * @ ^ +	D	15	35	100	5.3	53	64	6	9	9	0.150	1.22	1.10	0.49	0.12	0.11	0.05
95158 22 * @ ^ +	E	15	35	225	5.3	53	65.6	6	9	9	0.165	0.86	0.77	0.34	0.19	0.17	0.08
07016 149 * @ ^ +	D	22	35	400	7.7	77	92	6	9	9	0.150	0.61	0.55	0.24	0.24	0.22	0.10
07016 150 * @ ^ +	D	22	35	125	7.7	77	92	6	9	9	0.150	1.10	0.99	0.44	0.14	0.12	0.05
95158 23 * @ ^ +	E	22	35	300	7.7	77	96.3	6	9	9	0.165	0.74	0.67	0.30	0.22	0.20	0.09
07016 151 * @ ^ +	E	22	35	125	7.7	77	92	6	9	9	0.165	1.15	1.03	0.46	0.14	0.13	0.06
07016 152 M @ ^ +	D	33	35	300	11.6	116	139	6	9	9	0.150	0.71	0.64	0.28	0.21	0.19	0.08
07016 153 M @ ^ +	D	33	35	200	11.6	116	139	6	9	9	0.150	0.87	0.78	0.35	0.17	0.16	0.07
07016 154 M @ ^ +	E	33	35	300	11.6	116	139	6	9	9	0.165	0.74	0.67	0.30	0.22	0.20	0.09
07016 155 M @ ^ +	E	47	35	250	16.5	165	197	6	9	9	0.165	0.81	0.73	0.32	0.20	0.18	0.08
07016 156 M @ ^ +	V	47	35	200	16.5	165	197	6	9	9	0.250	1.12	1.01	0.45	0.22	0.20	0.09
07016 157 M @ ^ +	A	0.15	50	15000	0.5	5	6	4	6	6	0.075	0.07	0.06	0.03	1.06	0.95	0.42
07016 158 M @ ^ +	A	0.22	50	18000	0.5	5	6	4	6	6	0.075	0.06	0.06	0.03	1.16	1.05	0.46
07016 159 * @ ^ +	A	0.47	50	9500	0.5	5	6	4	6	6	0.075	0.09	0.08	0.04	0.84	0.76	0.34
07016 160 * @ ^ +	B	0.47	50	9500	0.5	5	6	4	6	6	0.085	0.09	0.09	0.04	0.90	0.81	0.36
07016 161 * @ ^ +	A	0.68	50	7900	0.5	5	6	4	6	6	0.075	0.10	0.09	0.04	0.77	0.69	0.31
07016 162 M @ ^ +	A	1.0	50	6600	0.5	5	6	4	6	6	0.075	0.11	0.10	0.04	0.70	0.63	0.28
07016 163 * @ ^ +	B	1.0	50	7000	0.5	5	6	4	6	6	0.085	0.11	0.10	0.04	0.77	0.69	0.31
07016 164 * @ ^ +	C	1.5	50	2000	0.8	8	10	6	8	9	0.110	0.23	0.21	0.09	0.47	0.42	0.19
07016 165 * @ ^ +	D	1.5	50	1500	0.8	8	10	6	8	9	0.150	0.32	0.28	0.13	0.47	0.43	0.19
07016 166 * @ ^ +	D	2.2	50	1200	1.1	11	13	6	8	9	0.150	0.35	0.32	0.14	0.42	0.38	0.17
07016 167 * @ ^ +	D	3.3	50	800	1.7	17	20	6	9	9	0.150	0.43	0.39	0.17	0.35	0.31	0.14
07016 168 * @ ^ +	D	4.7	50	300	2.4	24	29	6	9	9	0.150	0.71	0.64	0.28	0.21	0.19	0.08
07016 169 * @ ^ +	D	6.8	50	600	3.4	34	41	6	6	6	0.150	0.50	0.45	0.20	0.30	0.27	0.12
07016 170 * @ ^ +	D	6.8	50	300	3.4	34	41	6	6	6	0.150	0.71	0.64	0.28	0.21	0.19	0.08

All technical data relates to an ambient temperature of +25°C. Capacitance and DF are measured at 120Hz, 0.5V RMS with a maximum DC bias of 2.2 volts. DCL is measured at rated voltage after 5 minutes.

NOTE: KYOCERA AVX reserves the right to supply a higher voltage rating or tighter tolerance part in the same case size, to the same reliability standards.

T4J SERIES

HRC4000 Implantable Non Life Support and Non Implantable Life Support

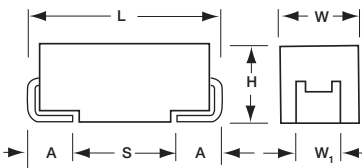

MARKING

A, B, C, D, E, U, V CASE

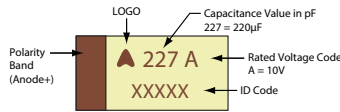

HOW TO ORDER

T4J	E	336	K	035	C		L	Q	4	^	00
Type	Case Size See table above	Capacitance Code pF code: 1st two digits represent significant figures 3rd digit represents multiplier (number of zeros to follow)	Tolerance K = ±10%	Rated DC Voltage 006 = 6.3Vdc 010 = 10Vdc 016 = 16Vdc 020 = 20Vdc 025 = 25Vdc 035 = 35Vdc 050 = 50Vdc	Standard or Low ESR Range C = Std ESR L = Low ESR	Packaging R = 7" Reel B = Bulk	Inspection Level L = Lab Inspection	Reliability Grade Q = Q-Process Screening	Qualification Level 4 = HCR4000	Termination 7 = 100% Tin 9 = Gold Plated H, 9 = (Contact Manufacturer) Non RoHS	Suffix 00 = Standard XX = Custom

The T4J series is designed for use in Implantable - Non-Life support or Non-Implantable - Life support medical applications. These components are screened using our newly designed Q-Process to effectively remove components that may experience parametric shifts through customer processing or display instability through life testing.



FEATURES

- Dedicated to medical applications
- HRC4000 - Implantable, Non-Life support
- Non-Implantable, Life support
- -55 to +125°C operation temperature
- Basic reliability better than 0.1%/1000hours
- Custom DCL / ESR options on selected parts

T4J Standard – Standard option DCL and ESR limits including Q-Process screening.

T4J Custom – A custom option where specific DCL and ESR parameter limits can be agreed based Q-Process statistical screening. DCL down to 0.005CV on selected codes

APPLICATIONS

- Medical, Implantable - Non-Life support and Non-Implantable - Life support

For additional information on Q-process please consult the KYOCERA AVX technical publication "Reaching the Highest Reliability for Tantalum Capacitors" (see the link: <http://www.avx.com/docs/techinfo/Qprocess.pdf>)

CASE DIMENSIONS: millimeters (inches)

Code	EIA Code	EIA Metric	L±0.20 (0.008)	W+0.20 (0.008) -0.10 (0.004)	H+0.20 (0.008) -0.10 (0.004)	W, ±0.20 (0.008)	A+0.30 (0.012) -0.20 (0.008)	S Min.
A	1206	3216-18	3.20 (0.126)	1.60 (0.063)	1.60 (0.063)	1.20 (0.047)	0.80 (0.031)	1.10 (0.043)
B	1210	3528-21	3.50 (0.138)	2.80 (0.110)	1.90 (0.075)	2.20 (0.087)	0.80 (0.031)	1.40 (0.055)
C	2312	6032-28	6.00 (0.236)	3.20 (0.126)	2.60 (0.102)	2.20 (0.087)	1.30 (0.051)	2.90 (0.114)
D	2917	7343-31	7.30 (0.287)	4.30 (0.169)	2.90 (0.114)	2.40 (0.094)	1.30 (0.051)	4.40 (0.173)
E	2917	7343-43	7.30 (0.287)	4.30 (0.169)	4.10 (0.162)	2.40 (0.094)	1.30 (0.051)	4.40 (0.173)
U	2924	7361-43	7.30 (0.287)	6.10 (0.240)	4.10 (0.162)	3.10 (0.122)	1.30 (0.051)	4.40 (0.173)
V	2924	7361-38	7.30 (0.287)	6.10 (0.240)	3.55 (0.140)	3.10 (0.122)	1.30 (0.051)	4.40 (0.173)

W₁ dimension applies to the termination width for A dimensional area only.

TECHNICAL SPECIFICATIONS

Technical Data:	All technical data relate to an ambient temperature of +25°C								
Capacitance Range:	1 µF to 1000 µF								
Capacitance Tolerance:	±10%								
Leakage Current DCL:	0.01CV (Custom potential down to 0.005CV available upon request)								
Rated Voltage (V _R)	≤ 85°C:	6.3	10	16	20	25	35	50	
Category Voltage (V _C)	≤125°C:	4	7	10	13	17	23	33	
Surge Voltage (V _S)	≤ 85°C:	8	13	20	26	32	46	65	
Surge Voltage (V _S)	≤125°C:	5	8	13	16	20	28	40	
Temperature Range:	-55°C to +125°C								
Reliability:	0.1% / 1000hrs at 25°C, VR with 0.1Ω/V series impedance, 90% confidence level								

T4J SERIES

HRC4000 Implantable Non Life Support and Non Implantable Life Support



CAPACITANCE AND RATED VOLTAGE, V_R (VOLTAGE CODE) RANGE (LETTER DENOTES CASE SIZE)

Capacitance		Rated Voltage DC (V_R) to 85°C (Voltage Code)						
μF	Code	6.3V (J)	10V (A)	16V (C)	20 (D)	25 (E)	35 (V)	50V (T)
1.0	105						A	C
1.5	155					A	B	C
2.2	225					B	B	C
3.3	335					B	B	C
4.7	475				B	B	C	D
6.8	685		A	B	B	C	C	D
10	106	A	A	B	B/C	C	C	E
15	156	A	B	B	C	C	D	
22	226	B	B	C	C	D	D	
33	336	B	C	C	D	D	E	
47	476	B/C	C	D	D	D		
68	686	B/C	C	D	E		V	
100	107	B/C	D	E	E			
150	157	D	D	E				
220	227	D	E	U				
330	337	E	E					
470	477	E	U					
680	687	U						
1000	108	V						

Available Ratings
Please contact the factory for codes not listed in the table.

Note: Voltage ratings are minimum values. KYOCERA AVX reserves the right to supply higher ratings in the same case size, to the same reliability standards with customer written approval.

T4J SERIES

HRC4000 Implantable Non Life Support and Non Implantable Life Support



RATINGS & PART NUMBER REFERENCE

Part No.	Case Size	Capacitance (µF)	Rated Voltage (V)	Rated Temperature (°C)	Category Voltage (V)	Category Temperature (°C)	DCL Max. (µA)	DF Max. (%)	ESR Max. @ 100kHz (mΩ)	MSL	100kHz RMS Current (mA)		
											25°C	85°C	125°C
6.3 Volt @ 85°C													
T4JA106K006C□LQ4^00	A	10	6.3	85	4	125	0.6	6	1500	3	224	201	89
T4JA156K006C□LQ4^00	A	15	6.3	85	4	125	0.9	6	1500	3	224	201	89
T4JB226K006C□LQ4^00	B	22	6.3	85	4	125	1.4	6	600	3	376	339	151
T4JB336K006C□LQ4^00	B	33	6.3	85	4	125	2.1	6	600	3	376	339	151
T4JB476K006C□LQ4^00	B	47	6.3	85	4	125	2.8	8	1500	3	238	214	95
T4JC476K006C□LQ4^00	C	47	6.3	85	4	125	3.0	6	300	3	606	545	242
T4JB686K006C□LQ4^00	B	68	6.3	85	4	125	4.0	8	900	3	307	277	123
T4JC686K006C□LQ4^00	C	68	6.3	85	4	125	4.3	6	300	3	606	545	242
T4JB107K006C□LQ4^00	B	100	6.3	85	4	125	3.0	10	1400	3	246	222	99
T4JC107K006C□LQ4^00	C	100	6.3	85	4	125	6.3	6	300	3	606	545	242
T4JD157K006C□LQ4^00	D	150	6.3	85	4	125	9.5	6	200	3	866	779	346
T4JD227K006C□LQ4^00	D	220	6.3	85	4	125	13.9	8	200	3	866	779	346
T4JE337K006C□LQ4^00	E	330	6.3	85	4	125	20.8	8	200	3	908	817	363
T4JE477K006C□LQ4^00	E	470	6.3	85	4	125	29.6	8	200	3	908	817	363
T4JU687K006C□LQ4^00	U	680	6.3	85	4	125	42.8	12	250	3	812	731	325
T4JV108K006C□LQ4^00	V	1000	6.3	85	4	125	60.0	16	200	3	1118	1006	447
10 Volt @ 85°C													
T4JA685K010C□LQ4^00	A	6.8	10	85	7	125	0.7	6	2000	3	194	174	77
T4JA106K010C□LQ4^00	A	10	10	85	7	125	1	6	2000	3	194	174	77
T4JB156K010C□LQ4^00	B	15	10	85	7	125	1.5	6	700	3	348	314	139
T4JB226K010C□LQ4^00	B	22	10	85	7	125	2.2	6	700	3	348	314	139
T4JC336K010C□LQ4^00	C	33	10	85	7	125	3.3	6	300	3	606	545	242
T4JC476K010C□LQ4^00	C	47	10	85	7	125	4.7	6	300	3	606	545	242
T4JC686K010C□LQ4^00	C	68	10	85	7	125	6.8	6	300	3	606	545	242
T4JD107K010C□LQ4^00	D	100	10	85	7	125	10.0	6	150	3	1000	900	400
T4JD157K010C□LQ4^00	D	150	10	85	7	125	15.0	8	150	3	1000	900	400
T4JE227K010C□LQ4^00	E	220	10	85	7	125	22.0	8	150	3	1049	944	420
T4JE337K010C□LQ4^00	E	330	10	85	7	125	33.0	8	150	3	1049	944	420
T4JU477K010C□LQ4^00	U	470	10	85	7	125	47.0	12	200	3	908	817	363
16 Volt @ 85°C													
T4JB685K016C□LQ4^00	B	6.8	16	85	10	125	1.1	6	1200	3	266	240	106
T4JB106K016C□LQ4^00	B	10	16	85	10	125	1.6	6	1200	3	266	240	106
T4JB156K016C□LQ4^00	B	15	16	85	10	125	2.4	6	1200	3	266	240	106
T4JC226K016C□LQ4^00	C	22	16	85	10	125	3.5	6	350	3	561	505	224
T4JC336K016C□LQ4^00	C	33	16	85	10	125	5.3	6	350	3	561	505	224
T4JD476K016C□LQ4^00	D	47	16	85	10	125	7.5	6	200	3	866	779	346
T4JD686K016C□LQ4^00	D	68	16	85	10	125	10.9	6	200	3	866	779	346
T4JE107K016C□LQ4^00	E	100	16	85	10	125	16.0	6	150	3	1049	944	420
T4JE157K016C□LQ4^00	E	150	16	85	10	125	24.0	6	150	3	1049	944	420
T4JU227K016C□LQ4^00	U	220	16	85	10	125	35.2	12	200	3	908	817	363
20 Volt @ 85°C													
T4JB475K020C□LQ4^00	B	4.7	20	85	13	125	1.0	6	1000	3	292	262	117
T4JB685K020C□LQ4^00	B	6.8	20	85	13	125	1.4	6	1000	3	292	262	117
T4JB106K020C□LQ4^00	B	10	20	85	13	125	1.0	6	1000	3	292	262	117
T4JB106K020L□LQ4^00	B	10	20	85	13	125	1.0	6	500	3	412	371	165
T4JC106K020C□LQ4^00	C	10	20	85	13	125	2.0	6	500	3	469	422	188
T4JC156K020C□LQ4^00	C	15	20	85	13	125	3.0	6	500	3	469	422	188
T4JC226K020C□LQ4^00	C	22	20	85	13	125	4.4	6	500	3	469	422	188
T4JD336K020C□LQ4^00	D	33	20	85	13	125	6.6	6	250	3	775	697	310
T4JD476K020C□LQ4^00	D	47	20	85	13	125	9.4	6	250	3	775	697	310
T4JE686K020C□LQ4^00	E	68	20	85	13	125	13.6	6	200	3	908	817	363
T4JE107K020C□LQ4^00	E	100	20	85	13	125	20.0	6	200	3	908	817	363

T4J SERIES

HRC4000 Implantable Non Life Support and Non Implantable Life Support



Part No.	Case Size	Capacitance (µF)	Rated Voltage (V)	Rated Temperature (°C)	Category Voltage (V)	Category Temperature (°C)	DCL Max. (µA)	DF Max. (%)	ESR Max. @ 100kHz (mΩ)	MSL	100kHz RMS Current (mA)		
											25°C	85°C	125°C
25 Volt @ 85°C													
T4JA155K025C□LQ4^00	A	1.5	25	85	17	125	0.4	6	3000	3	158	142	63
T4JB225K025C□LQ4^00	B	2.2	25	85	17	125	0.6	6	2000	3	206	186	82
T4JB335K025C□LQ4^00	B	3.3	25	85	17	125	0.8	6	2000	3	206	186	82
T4JB475K025C□LQ4^00	B	4.7	25	85	17	125	1.2	6	2000	3	206	186	82
T4JC685K025C□LQ4^00	C	6.8	25	85	17	125	1.7	6	600	3	428	385	171
T4JC106K025C□LQ4^00	C	10	25	85	17	125	2.5	6	600	3	428	385	171
T4JC156K025C□LQ4^00	C	15	25	85	17	125	3.8	6	600	3	428	385	171
T4JD226K025C□LQ4^00	D	22	25	85	17	125	5.5	6	400	3	612	551	245
T4JD336K025C□LQ4^00	D	33	25	85	17	125	8.3	6	400	3	612	551	245
T4JD476K025C□LQ4^00	D	47	25	85	17	125	11.8	6	400	3	612	551	245
35 Volt @ 85°C													
T4JA105K035C□LQ4^00	A	1.0	35	85	23	125	0.4	6	3000	3	158	142	63
T4JA105K035L□LQ4^00	A	1.0	35	85	23	125	0.2	6	1000	3	274	246	110
T4JB155K035C□LQ4^00	B	1.5	35	85	23	125	0.5	6	2500	3	184	166	74
T4JB225K035C□LQ4^00	B	2.2	35	85	23	125	0.8	6	2500	3	184	166	74
T4JB335K035C□LQ4^00	B	3.3	35	85	23	125	1.2	6	2500	3	184	166	74
T4JC475K035C□LQ4^00	C	4.7	35	85	23	125	1.6	6	600	3	428	385	171
T4JC685K035C□LQ4^00	C	6.8	35	85	23	125	2.4	6	600	3	428	385	171
T4JC106K035C□LQ4^00	C	10	35	85	23	125	3.5	6	600	3	428	385	171
T4JD156K035C□LQ4^00	D	15	35	85	23	125	5.3	6	400	3	612	551	245
T4JD226K035C□LQ4^00	D	22	35	85	23	125	7.7	6	400	3	612	551	245
T4JE336K035C□LQ4^00	E	33	35	85	23	125	11.6	6	250	3	812	731	325
T4JV686K035C□LQ4^00	V	68	35	85	23	125	23.8	6	500	3	707	636	283
50 Volt @ 85°C													
T4JC105K050C□LQ4^00	C	1	50	85	33	125	0.5	4	1500	3	271	244	108
T4JC155K050C□LQ4^00	C	1.5	50	85	33	125	0.8	6	1500	3	271	244	108
T4JC225K050C□LQ4^00	C	2.2	50	85	33	125	1.1	6	1500	3	271	244	108
T4JC335K050C□LQ4^00	C	3.3	50	85	33	125	1.7	6	1500	3	271	244	108
T4JD475K050C□LQ4^00	D	4.7	50	85	33	125	2.4	4.5	600	3	500	450	200
T4JD685K050C□LQ4^00	D	6.8	50	85	33	125	3.4	4.5	600	3	500	450	200
T4JE106K050C□LQ4^00	E	10	50	85	33	125	5.0	4.5	400	3	642	578	257

Moisture Sensitivity Level (MSL) is defined according to J-STD-020.

All technical data relates to an ambient temperature of +25°C. Capacitance and DF are measured at 120Hz, 0.5V RMS with a maximum DC bias of 2.2 volts. DCL is measured at rated voltage after 5 minutes.

The EIA & CECC standards for low ESR Solid Tantalum Capacitors allow an ESR movement to 1.25 times catalogue limit post mounting.

NOTICE: The specifications set forth herein are subject to change without notice and are typical and may not apply to all applications. KYOCERA AVX does not warrant or guarantee any aspect of the operation or use of any product except as explicitly set forth in the product specification. Unless specifically agreed to in writing, Seller has not tested or certified its products, services or deliverables for use in high risk applications including medical life support, medical device, direct physical patient contact, water treatment, nuclear facilities, weapon systems, mass and air transportation control, flammable environments, or any other potentially life critical uses. By ordering or using KYOCERA AVX products, the user understands and agrees that KYOCERA AVX makes no assurances that the products, services or deliverables are suitable for any high risk uses.

Under no circumstances does Seller warrant or guarantee suitability for any customer design or manufacturing process. Any statements herein are believed to be true, but are presented without warranty of any kind, explicit or implied. Statements concerning use of KYOCERA AVX products are made without any representation that such use is a non-infringing use or is consistent with any regulation. Users should not assume that any or all safety measures are indicated.

T4J SERIES

HRC4000 Implantable Non Life Support and Non Implantable Life Support



QUALIFICATION TABLE

TEST	T4J HRC4000 (Temperature range -55°C to +125°C)										
	Condition			Characteristics							
Endurance	Determine after application of rated voltage for 2000 +48/-0 hours at 85±2°C and then leaving 1-2 hours at room temperature. Also determine of 125°C temperature, category voltage for 2000 +48/-0 hours and then leaving 1-2 hours at room temperature. Power supply impedance to be ≤0.1Ω/V.			Visual examination	no visible damage						
				DCL	1.25 x initial limit						
				ΔC/C	within ±10% of initial value						
				DF	initial limit						
				ESR	1.25 x initial limit						
Storage Life	125°C, 0V, 2000h			Visual examination	no visible damage						
				DCL	1.25 x initial limit						
				ΔC/C	within ±10% of initial value						
				DF	initial limit						
				ESR	1.25 x initial limit						
Temperature Stability	Step	Temperature°C	Duration (min)		+20°C	-55°C	+20°C	+85°C	+125°C	+20°C	
	1	+20±2	15	DCL	IL*	n/a	IL*	10 x IL*	12.5 x IL*	IL*	
	2	-55+0/-3	15		ΔC/C	n/a	+0/-10%	±5%	+10/-0%	+12/-0%	±5%
	3	+20±2	15	DF		IL*	1.5 x IL*	IL*	1.5 x IL*	2 x IL*	IL*
	4	+85+3/-0	15		ESR	1.25 x IL*	2.5 x IL*	1.25 x IL*	1.25 x IL*	1.25 x IL*	1.25 x IL*
	5	+125+3/-0	15								
	6	+20±2	15								
Surge Voltage	Test temperature: 125°C±3/0°C Test voltage: Category voltage at 125°C Surge voltage: 1.3x category voltage at 125°C Series protection resistance 1000±100Ω Discharge resistance: 1000Ω Number of cycles: 1000x Cycle duration: 6min; 30 sec charge, 5min 30 sec discharge			Visual examination	no visible damage						
				DCL	initial limit						
				ΔC/C	within ±5% of initial value						
				DF	initial limit						
				ESR	1.25 x initial limit						

*Initial Limit

LOT ACCEPTANCE TESTING

TEST	T4J HRC4000 (Temperature range -55°C to +125°C)		
	Condition	Characteristics	
Lot Acceptance Test	25 Pieces from each lot • Read and Record Initial Electricals • Bake Out @ 125°C for 2 Hours • Mount using KYOCERA AVX recommended profile • Read and Record Post Mounting Electricals • Life Test: 6 hours, 2/3 R.V., 125°C • Read and Record Post Electricals	DCL	initial limit
		ΔC/C	within ±5% of initial value
		DF	initial limit
		ESR	1.25 x initial limit
		0 Failures Allowed	

TBM MULTIANODE

Tantalum Ultra Low ESR Space Level

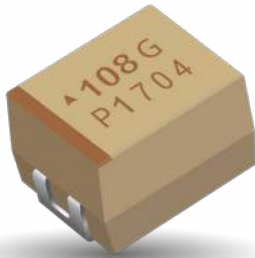

TBM Space Level series is screened to SRC9000 or T Level and utilizes an internal multi-anode design to achieve ultra-low ESR which improves performance in high ripple power application. TBM Space Level is available with Weibull Grade "C" reliability and MIL-PRF-55365 surge test option "C".

There are four termination finishes available: solder plated, fused solder plated, hot solder dipped and gold plated (these correspond to "H", "K", "C" and "B" termination, respectively, per MIL-PRF-55365).

The molding compound has been selected to meet the requirements of UL94V-0 (Flame Retardancy) and outgassing requirements of ASTM E-595.

For moisture sensitivity levels please refer to the High Reliability Tantalum MSL section located in the back of the High Reliability Tantalum Catalog.

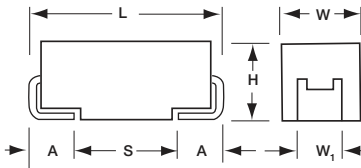

CASE DIMENSIONS: millimeters (inches)

Code	L±0.20 (0.008)	W+0.20 (0.008) -0.10 (0.004)	H+0.20 (0.008) -0.10 (0.004)	W ₁ ±0.20 (0.008)	A+0.30 (0.012) -0.20 (0.008)	S Min.
D	7.30 (0.287)	4.30 (0.169)	2.90 (0.114)	2.40 (0.094)	1.30 (0.051)	4.40 (0.173)
E	7.30 (0.287)	4.30 (0.169)	4.10 (0.162)	2.40 (0.094)	1.30 (0.051)	4.40 (0.173)

W₁ dimension applies to the termination width for A dimensional area only.

MARKING

D, E CASE

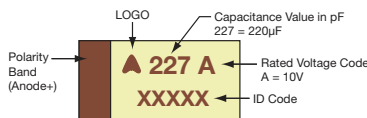

CAPACITANCE AND RATED VOLTAGE RANGE

LETTER DENOTES CASE SIZE ESR LIMIT IN BRACKETS

Capacitance		Rated Voltage DC (V _R) to 85°C								
µF	Code	2.5V (e)	4V (G)	6V (J)	10V (A)	12V (B)	16V (C)	20V (D)	25V (E)	35V (V)
22	226									D(70) E(60,100)
33	336								D(65) E(65)	E(50,65)
47	476									
68	686									
100	107							E(35,45)		
150	157						E(30,40)			
220	227				D(35)	E(35)				
330	337		D(35)	D(35)	E(35)					
470	477		D(35)	E(30)						
680	687		E(23)							
1000	108	D(25)	E(23)							
1500	158	E(18)								

Available Ratings: ESR limits quoted in brackets (mOhms)

Notes: Voltage ratings are minimum values. KYOCERA AVX reserves the right to supply higher ratings in the same case size, to the same reliability standards.

EIA standards for Low ESR solid tantalum capacitors allow an ESR movement of 1.25 times initial limit post mounting.

MULTIANODE CONSTRUCTION

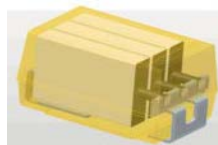

MULTIANODE TBM D LOW SELF INDUCTANCE CONSTRUCTION "MIRROR" DESIGN

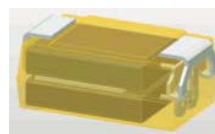

TBM MULTIANODE

Tantalum Ultra Low ESR Space Level

HOW TO ORDER

SPACE LEVEL SCREENING TO SRC9000 OR T LEVEL*:

TBM	E	477	*	006	L	□	L	@	#	^	++
Type	Case Size	Capacitance Code	Capacitance Tolerance	Voltage Code	Standard or Low ESR Range	Packaging	Inspection Level	Reliability Grade	Qualification Level	Termination Finish	Surge Test Option
		pF code: 1st two digits represent significant figures 3rd digit represents multiplier (number of zeros to follow)	M = ±20% K = ±10%	002 = 2.5Vdc 004 = 4Vdc 006 = 6Vdc 010 = 10Vdc 012 = 12Vdc 016 = 16Vdc 020 = 20Vdc 025 = 25Vdc 035 = 35Vdc	C = Std ESR L = Low ESR	B = Bulk R = 7" T&R S = 13" T&R W = Waffle See page 8 for additional packaging options.	L = Group A	Weibull: C = 0.01%/1000 hrs. 90% conf.	9 = SRC9000 T=T Level	H = Solder Plated 0 = Fused Solder Plated 8 = Hot Solder Dipped 9 = Gold Plated	45 = 10 cycles, -55°C & +85°C before Weibull GC = Group C Testing and Data OR = TOR compliant testing and data
<p><small>For RoHS compliant products, please select correct termination style.</small></p>											

*The product in this series is non-QPL. See Test Options chart for screening available.

TECHNICAL SPECIFICATIONS

Technical Data:	Unless otherwise specified, all technical data relate to an ambient temperature of +25°C										
Capacitance Range:	22 µF to 1500 µF										
Capacitance Tolerance:	±10%; ±20%										
Rated Voltage DC (V _R)	≤ +85°C:	2.5	4	6	10	12	16	20	25	35	
Category Voltage (V _C)	≤+125°C:	1.7	2.7	4	7	8.4	10	13	17	23	
Surge Voltage (V _S)	≤ +85°C:	3.3	5.2	8	13	15.6	20	26	32	46	
Surge Voltage (V _S)	≤+125°C:	2.2	3.4	5	8	9.6	12	16	20	28	
Temperature Range:	-55°C to +125°C										

TBM MULTIANODE

Tantalum Ultra Low ESR Space Level



RATING & PART NUMBER REFERENCE		Parametric Specifications by Rating									Typical RMS Ripple Data by Rating						
		Cap @ 120Hz	DC Rated Voltage	ESR @ 100kHz	DCL max			DF Max			Power Dissipation	25°C Ripple	85°C Ripple	125°C Ripple	25°C Ripple	85°C Ripple	125°C Ripple
					+25°C	+85°C	+125°C	+25°C	+(85/125)°C	-55°C							
P/N	Case	µF @ 25°C	V @ +85°C	mOhms @ +25°C	(µA)	(µA)	(µA)	(%)	(%)	(%)	W	A (100kHz)	A (100kHz)	A (100kHz)	V (100kHz)	V (100kHz)	V (100kHz)
2.5 Volt @ 85°C (1.7 Volt @ 125°C)																	
TBMD108*002L□LC#^++	D	1000	2.5	25	18.8	188	376	8	11	12	0.255	3.194	2.874	1.277	0.080	0.072	0.032
TBME158*002C□LC#^++	E	1500	2.5	18	28.1	281	562	6	9	10	0.270	3.873	3.486	1.549	0.070	0.063	0.028
4 Volt @ 85°C (2.7 Volt @ 125°C)																	
TBMD337*004L□LC#^++	D	330	4	35	9.9	99	198	8	11	12	0.255	2.699	2.429	1.080	0.094	0.085	0.038
TBMD477*004L□LC#^++	D	470	4	35	14.1	141	282	8	11	12	0.255	2.699	2.429	1.080	0.094	0.085	0.038
TBME687*004C□LC#^++	E	680	4	23	20.4	204	408	6	9	10	0.270	3.426	3.084	1.370	0.079	0.071	0.032
TBME108*004C□LC#^++	E	1000	4	23	30	300	600	6	9	10	0.270	3.426	3.084	1.370	0.079	0.071	0.032
6 Volt @ 85°C (4 Volt @ 125°C)																	
TBMD337*006L□LC#^++	D	330	6	35	14.9	149	298	8	11	12	0.255	2.699	2.429	1.080	0.094	0.085	0.038
TBME477*006C□LC#^++	E	470	6	30	21.2	212	424	6	9	10	0.270	3.000	2.700	1.200	0.090	0.081	0.036
10 Volt @ 85°C (7 Volt @ 125°C)																	
TBMD227*010L□LC#^++	D	220	10	35	16.5	165	330	8	11	12	0.255	2.699	2.429	1.080	0.094	0.085	0.038
TBME337*010C□LC#^++	E	330	10	35	24.8	248	496	6	9	10	0.270	2.777	2.500	1.111	0.097	0.087	0.039
12 Volt @ 85°C (8.4 Volt @ 125°C)																	
TBME227*012C□LC#^++	E	220	12	35	19.8	198	396	6	9	10	0.270	2.777	2.500	1.111	0.097	0.087	0.039
16 Volt @ 85°C (10 Volt @ 125°C)																	
TBME157*016L□LC#^++	E	150	16	30	18	180	360	6	9	10	0.270	3.000	2.700	1.200	0.090	0.081	0.036
TBME157*016C□LC#^++	E	150	16	40	18	180	360	6	9	10	0.270	2.598	2.338	1.039	0.104	0.094	0.042
20 Volt @ 85°C (13 Volt @ 125°C)																	
TBME107*020L□LC#^++	E	100	20	35	15	150	300	6	9	10	0.270	2.777	2.500	1.111	0.097	0.087	0.039
TBME107*020C□LC#^++	E	100	20	45	15	150	300	6	9	10	0.270	2.449	2.205	0.980	0.110	0.099	0.044
25 Volt @ 85°C (17 Volt @ 125°C)																	
TBMD336*025L□LC#^++	D	33	25	65	6.2	62	124	8	11	12	0.255	1.981	1.783	0.792	0.129	0.116	0.051
TBME476*025L□LC#^++	E	47	25	65	8.8	88	176	6	9	10	0.270	2.038	1.834	0.815	0.132	0.119	0.053
35 Volt @ 85°C (23 Volt @ 125°C)																	
TBMD226*035L□LC#^++	D	22	35	70	5.8	58	116	8	11	12	0.255	1.909	1.718	0.763	0.134	0.120	0.053
TBME226*035L□LC#^++	E	22	35	60	5.8	58	116	6	9	10	0.270	2.121	1.909	0.849	0.127	0.115	0.051
TBME226*035C□LC#^++	E	22	35	100	5.8	58	116	6	9	10	0.270	1.643	1.479	0.657	0.164	0.148	0.066
TBME336*035L□LC#^++	E	33	35	50	8.7	87	174	6	9	10	0.270	2.324	2.091	0.930	0.116	0.105	0.046
TBME336*035C□LC#^++	E	33	35	65	8.7	87	174	6	9	10	0.270	2.038	1.834	0.815	0.132	0.119	0.053

All technical data relates to an ambient temperature of +25°C. Capacitance and DF are measured at 120Hz, 0.5V RMS with a maximum DC bias of 2.2 volts. DCL is measured at rated voltage after 5 minutes.

NOTE: KYOCERA AVX reserves the right to supply a higher voltage rating or tighter tolerance part in the same case size, to the same reliability standards.

TBM MULTIANODE

Tantalum Ultra Low ESR COTS-Plus

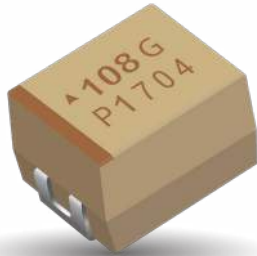

TBM COTS-Plus series uses an internal multi-anode design to achieve ultra-low ESR which improves performance in high ripple power applications.

TBM is available with Weibull Grade "B" reliability and all MIL-PRF-55365 Rev. G surge test options ("A", "B" & "C").

There are four termination finishes available: solder plated, fused solder plated, hot solder dipped and gold plated (these correspond to "H", "K", "C" and "B" termination, respectively, per MIL-PRF-55365).

The molding compound has been selected to meet the requirements of UL94V-0 (Flame Retardancy) and outgassing requirements of ASTM E-595.

For moisture sensitivity levels please refer to the High Reliability Tantalum MSL section located in the back of the High Reliability Tantalum Catalog.

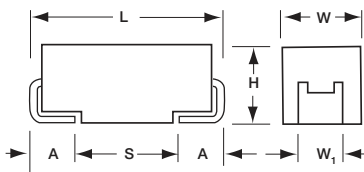

CASE DIMENSIONS: millimeters (inches)

Code	L±0.20 (0.008)	W+0.20 (0.008) -0.10 (0.004)	H+0.20 (0.008) -0.10 (0.004)	W ₁ ±0.20 (0.008)	A+0.30 (0.012) -0.20 (0.008)	S Min.
D	7.30 (0.287)	4.30 (0.169)	2.90 (0.114)	2.40 (0.094)	1.30 (0.051)	4.40 (0.173)
E	7.30 (0.287)	4.30 (0.169)	4.10 (0.162)	2.40 (0.094)	1.30 (0.051)	4.40 (0.173)
V	7.30 (0.287)	6.10 (0.240)	3.55 (0.140)	3.10 (0.122)	1.30 (0.051)	4.40 (0.173)

W₁ dimension applies to the termination width for A dimensional area only.

MARKING

D, E, V CASE

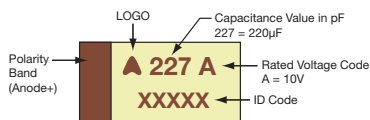

CAPACITANCE AND RATED VOLTAGE RANGE

LETTER DENOTES CASE SIZE ESR LIMIT IN BRACKETS

Capacitance		Rated Voltage DC (V _R) to 85°C								
µF	Code	2.5V (e)	4V (G)	6V (J)	10V (A)	12V (B)	16V (C)	20V (D)	25V (E)	35V (V)
22	226									D(70) E(60,100)
33	336								D(65)	E(50,65)
47	476								E(65)	E(55)
68	686								E(45)	
100	107							E(35,45)		
150	157						E(30,40)			
220	227				D(35)	E(35)	E(25)			
330	337		D(35)	D(35)	E(23,35)					
470	477		D(35)	E(18,30)	E(23)					
680	687		E(18,23)	E(18), V(23)						
1000	108	D(25)	E(18,23) V(18)							
1500	158	E(12,18)	E(15)							
2000	208									

Available Ratings: ESR limits quoted in brackets (mOhms)

Notes: Voltage ratings are minimum values. KYOCERA AVX reserves the right to supply higher ratings in the same case size, to the same reliability standards.

EIA standards for Low ESR solid tantalum capacitors allow an ESR movement of 1.25 times initial limit post mounting.

MULTIANODE CONSTRUCTION

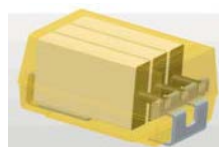

MULTIANODE TBM D LOW SELF INDUCTANCE CONSTRUCTION "MIRROR" DESIGN

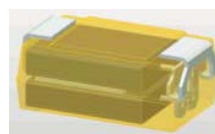

The Important Information/Disclaimer is incorporated in the catalog where these specifications came from or available online at www.kyocera-avx.com/disclaimer/ by reference and should be reviewed in full before placing any order.

TBM MULTIANODE

Tantalum Ultra Low ESR COTS-Plus

HOW TO ORDER

COTS-PLUS:

TBM	E	477	*	006	L	□	#	@	0	^	++
Type	Case Size	Capacitance Code pF code: 1st two digits represent significant figures 3rd digit represents multiplier (number of zeros to follow)	Capacitance Tolerance M = ±20% K = ±10%	Voltage Code 002 = 2.5Vdc 004 = 4Vdc 006 = 6Vdc 010 = 10Vdc 012 = 12Vdc 016 = 16Vdc 020 = 20Vdc 025 = 25Vdc 035 = 35Vdc	Standard or Low ESR Range C = Std ESR L = Low ESR	Packaging B = Bulk R = 7" T&R S = 13" T&R W = Waffle See page 8 for additional packaging options.	Inspection Level S = Std. Conformance L = Group A	Reliability Grade Weibull: B = 0.1%/1000 hrs. 90% conf. C = 0.01%/1000 hrs. 90% conf. Z = Non-ER	Qualification Level 0 = N/A	Termination Finish H = Solder Plated 0 = Fused Solder Plated 8 = Hot Solder Dipped 9 = Gold Plated 7 = Matte Sn	Surge Test Option 00 = None 23 = 10 Cycles, +25°C 24 = 10 Cycles, -55°C & +85°C 45 = 10 cycles, -55°C & +85°C before Weibull



For RoHS compliant products, please select correct termination style.

TECHNICAL SPECIFICATIONS

Technical Data: Unless otherwise specified, all technical data relate to an ambient temperature of +25°C

Capacitance Range:	22 µF to 1500 µF										
Capacitance Tolerance:	±10%; ±20%										
Rated Voltage DC (V _R)	≤ +85°C:	2.5	4	6	10	12	16	20	25	35	
Category Voltage (V _C)	≤ +125°C:	1.7	2.7	4	7	8.4	10	13	17	23	
Surge Voltage (V _S)	≤ +85°C:	3.3	5.2	8	13	15.6	20	26	32	46	
Surge Voltage (V _S)	≤ +125°C:	2.2	3.4	5	8	9.6	12	16	20	28	
Temperature Range:	-55°C to +125°C										

TBM MULTIANODE

Tantalum Ultra Low ESR COTS-Plus



RATING & PART NUMBER REFERENCE		Parametric Specifications by Rating									Typical RMS Ripple Data by Rating						
		Cap @ 120Hz	DC Rated Voltage	ESR @ 100kHz	DCL max			DF Max			Power Dissipation	25°C Ripple Current	85°C Ripple Current	125°C Ripple Current	25°C Ripple Voltage	85°C Ripple Voltage	125°C Ripple Voltage
					+25°C	+85°C	+125°C	+25°C	+(85/125)°C	-55°C							
P/N	Case	µF @ 25°C	V @ +85°C	mOhms @ +25°C	(µA)	(µA)	(µA)	(%)	(%)	(%)	W	A (100kHz)	A (100kHz)	A (100kHz)	V (100kHz)	V (100kHz)	V (100kHz)
2.5 Volt @ 85°C (1.7 Volt @ 125°C)																	
TBMD108*002L□#@0^++	D	1000	2.5	25	18.8	188	376	8	11	12	0.255	3.194	2.874	1.277	0.080	0.072	0.032
TBME158*002C□#@0^++	E	1500	2.5	18	28.1	281	562	6	9	10	0.270	3.873	3.486	1.549	0.070	0.063	0.028
TBME158*002L□#@0^++	E	1500	2.5	12	38	380	760	6	9	10	0.270	4.743	4.269	1.897	0.057	0.051	0.023
4 Volt @ 85°C (2.7 Volt @ 125°C)																	
TBMD337*004L□#@0^++	D	330	4	35	9.9	99	198	8	11	12	0.255	2.699	2.429	1.080	0.094	0.085	0.038
TBMD477*004L□#@0^++	D	470	4	35	14.1	141	282	8	11	12	0.255	2.699	2.429	1.080	0.094	0.085	0.038
TBME687*004C□#@0^++	E	680	4	23	20.4	204	408	6	9	10	0.270	3.426	3.084	1.370	0.079	0.071	0.032
TBME687*004L□#@0^++	E	680	4	18	27	270	540	6	9	10	0.270	3.873	3.486	1.549	0.070	0.063	0.028
TBME108*004C□#@0^++	E	1000	4	23	30	300	600	6	9	10	0.270	3.426	3.084	1.370	0.079	0.071	0.032
TBME108*004L□#@0^++	E	1000	4	18	40	400	800	6	9	10	0.270	3.873	3.486	1.549	0.070	0.063	0.028
TBMV108*004L□#@0^++	V	1000	4	18	40	400	800	6	9	10	0.285	3.979	3.581	1.592	0.072	0.064	0.029
TBME158*004L□#@0^++	E	1500	4	15	40	400	800	6	9	10	0.270	4.243	3.818	1.697	0.064	0.057	0.025
6 Volt @ 85°C (4 Volt @ 125°C)																	
TBMD337*006L□#@0^++	D	330	6	35	14.9	149	298	8	11	12	0.255	2.699	2.429	1.080	0.094	0.085	0.038
TBME477*006C□#@0^++	E	470	6	30	21.2	212	424	6	9	10	0.270	3.000	2.700	1.200	0.090	0.081	0.036
TBME477*006L□#@0^++	E	470	6	18	28	280	560	6	9	10	0.270	3.873	3.486	1.549	0.070	0.063	0.028
TBME687*006L□#@0^++	E	680	6	18	41	410	820	6	9	10	0.270	3.873	3.486	1.549	0.070	0.063	0.028
TBMV687*006L□#@0^++	V	680	6	23	41	410	820	6	9	10	0.285	3.520	3.168	1.408	0.081	0.073	0.032
10 Volt @ 85°C (7 Volt @ 125°C)																	
TBMD227*010L□#@0^++	D	220	10	35	16.5	165	330	8	11	12	0.255	2.699	2.429	1.080	0.094	0.085	0.038
TBME337*010C□#@0^++	E	330	10	35	24.8	248	496	6	9	10	0.270	2.777	2.500	1.111	0.097	0.087	0.039
TBME337*010L□#@0^++	E	330	10	23	33	330	660	6	9	10	0.270	3.426	3.084	1.370	0.079	0.071	0.032
TBME477*010L□#@0^++	E	470	10	23	47	470	940	6	9	10	0.270	3.426	3.084	1.370	0.079	0.071	0.032
12 Volt @ 85°C (8.4 Volt @ 125°C)																	
TBME227*012C□#@0^++	E	220	12	35	19.8	198	396	6	9	10	0.270	2.777	2.500	1.111	0.097	0.087	0.039
16 Volt @ 85°C (10 Volt @ 125°C)																	
TBME157*016C□#@0^++	E	150	16	40	18	180	360	6	9	10	0.270	2.598	2.338	1.039	0.104	0.094	0.042
TBME157*016L□#@0^++	E	150	16	30	18	180	360	6	9	10	0.270	3.000	2.700	1.200	0.090	0.081	0.036
TBME227*016L□#@0^++	E	220	16	25	35	350	700	6	9	10	0.270	3.286	2.958	1.315	0.082	0.074	0.033
20 Volt @ 85°C (13 Volt @ 125°C)																	
TBME107*020C□#@0^++	E	100	20	45	15	150	300	6	9	10	0.270	2.449	2.205	0.980	0.110	0.099	0.044
TBME107*020L□#@0^++	E	100	20	35	15	150	300	6	9	10	0.270	2.777	2.500	1.111	0.097	0.087	0.039
25 Volt @ 85°C (17 Volt @ 125°C)																	
TBMD336*025L□#@0^++	D	33	25	65	6.2	62	124	8	11	12	0.255	1.981	1.783	0.792	0.129	0.116	0.051
TBME476*025L□#@0^++	E	47	25	65	8.8	88	176	6	9	10	0.270	2.038	1.834	0.815	0.132	0.119	0.053
TBME686*025L□#@0^++	E	68	25	45	17	170	340	6	9	10	0.270	2.449	2.205	0.980	0.110	0.099	0.044
35 Volt @ 85°C (23 Volt @ 125°C)																	
TBMD226*035L□#@0^++	D	22	35	70	5.8	58	116	8	11	12	0.255	1.909	1.718	0.763	0.134	0.120	0.053
TBME226*035C□#@0^++	E	22	35	100	5.8	58	116	6	9	10	0.270	1.643	1.479	0.657	0.164	0.148	0.066
TBME226*035L□#@0^++	E	22	35	60	5.8	58	116	6	9	10	0.270	2.121	1.909	0.849	0.127	0.115	0.051
TBME336*035C□#@0^++	E	33	35	65	8.7	87	174	6	9	10	0.270	2.038	1.834	0.815	0.132	0.119	0.053
TBME336*035L□#@0^++	E	33	35	50	8.7	87	174	6	9	10	0.270	2.324	2.091	0.930	0.116	0.105	0.046
TBME476*035L□#@0^++	E	47	35	55	16	160	320	6	9	10	0.270	2.216	1.994	0.886	0.122	0.110	0.049

All technical data relates to an ambient temperature of +25°C. Capacitance and DF are measured at 120Hz, 0.5V RMS with a maximum DC bias of 2.2 volts. DCL is measured at rated voltage after 5 minutes.

NOTE: KYOCERA AVX reserves the right to supply a higher voltage rating or tighter tolerance part in the same case size, to the same reliability standards.



The Important Information/Disclaimer is incorporated in the catalog where these specifications came from or available online at www.kyocera-avx.com/disclaimer/ by reference and should be reviewed in full before placing any order.

TBC SERIES

CWR15 MIL-PRF-55365/12 Established Reliability, COTS-Plus & Space Level

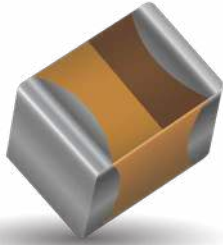

KYOCERA AVX announces the world's smallest military approved tantalum chip capacitors. The CWR15 offers 0603, 0805 and 1206 case sizes in capacitance/ voltage combinations previously only available in much larger packages. The revolutionary TACmicrochip® technology offers designers significant opportunity to downsize circuits for military and aerospace applications. The product is manufactured in the Tantalum high reliability facility in Biddeford, Maine which is also home to the CWR09, CWR11, CWR19 and CWR29 product lines. For moisture sensitivity levels please refer to the High Reliability Tantalum MSL section located in the back of the High Reliability Tantalum Catalog.

CASE DIMENSIONS:

millimeters (inches)

Case Code	Length (L)	Width (W)	Height (H)	Term. Width (W ₁)
A	3.20±0.20 (0.126±0.008)	1.60±0.20 (0.063±0.008)	1.60±0.20 (0.063±0.008)	0.15+0.35/-0.00 (0.006+0.014/-0.000)
L	1.60+0.25/-0.15 (0.063+0.010/-0.006)	0.84+0.20/-0.10 (0.033+0.008/-0.004)	0.84+0.20/-0.10 (0.033+0.008/-0.004)	0.15+0.35/-0.00 (0.006+0.014/-0.000)
R	2.00+0.25/-0.15 (0.079+0.010/-0.006)	1.35+0.20/-0.10 (0.053+0.008/-0.004)	1.35+0.20/-0.10 (0.053+0.008/-0.004)	0.15+0.35/-0.00 (0.006+0.014/-0.000)

MARKING

A, L, R CASE

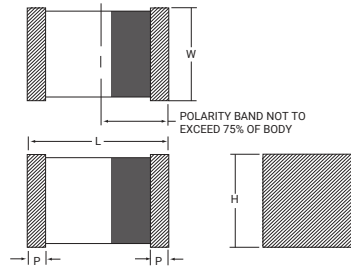
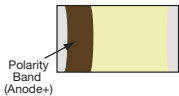

CAPACITANCE AND RATED VOLTAGE, V_R (VOLTAGE CODE) RANGE (LETTER DENOTES CASE SIZE)

Capacitance		Voltage Rating DC (V _R) at 85°C			
μF	Code	4V (C)	6V (D)	10V (F)	20V (J)
0.47	474			L	L
0.68	684			L	
1.0	105			L	
1.5	155			L	
2.2	225			L	
3.3	335		L	R	
4.7	475		L	R	
6.8	685	L	R	R	
10	106	R	R	R	
15	156	R	R	A	
22	226	R	A		
33	336	R	A		
47	476		A		
68	686	A			

TBC SERIES

CWR15 MIL-PRF-55365/12 Established Reliability, COTS-Plus & Space Level



HOW TO ORDER

COTS-PLUS & MIL QPL (CWR15):

TBC	L	685	*	004	C	□	#	@	0	^	++
Type	Case Size	Capacitance Code pF code: 1st two digits represent significant figures 3rd digit represents multiplier (number of zeros to follow)	Capacitance Tolerance M = ±20% K = ±10% J = ±5%	Voltage Code 004 = 4Vdc 006 = 6Vdc 010 = 10Vdc 020 = 20Vdc	ESR C = Std ESR	Packaging B = Bulk R = 7" T&R W = Waffle See page 8 for additional packaging options.	Inspection Level S = Std. Conformance L = Group A M = MIL (JAN) CWR15	Reliability Grade Weibull: B = 0.1%/1000 hrs. 90% conf. C = 0.01%/1000 hrs. 90% conf. D = 0.001%/1000 hrs. 90% conf. Z = Non-ER	Qualification Level 0 = N/A T = T Level 9 = SRC9000	Termination Finish 0 = Fused Solder Plated 9 = Gold Plated 7 = Matte Sn (COTS-Plus only)	Surge Test Option 00 = None 23 = 10 Cycles, +25°C 24 = 10 Cycles, -55°C & +85°C 45 = 10 cycles, -55°C & +85°C before Weibull

For RoHS compliant products, please select correct termination style.

CWR15 P/N CROSS REFERENCE:

CWR15	F	C	685	*	C	L	+
Type	Voltage Code C = 4Vdc D = 6Vdc F = 10Vdc J = 20Vdc	Termination Finish B = Gold Plated K = Solder Fused	Capacitance Code pF code: 1st two digits represent significant figures 3rd digit represents number of zeros to follow	Capacitance Tolerance J = ±5% K = ±10% M = ±20% See page 8 for additional packaging options.	Product Level Designator Weibull: B = 0.1%/1000 hrs. 90% conf. C = 0.01%/1000 hrs. 90% conf. D = 0.001%/1000 hrs. 90% conf. T = T Level A = Non-ER	Case Size	Surge Test Option A = +25°C after Weibull B = -55°C & +85°C after Weibull C = -55°C & +85°C before Weibull Z = None Required

For RoHS compliant products, please select correct termination style.

SPACE LEVEL OPTIONS TO SRC9000*:

TBC	L	685	*	004	C	□	L	C	9	^	++
Type	Case Size	Capacitance Code pF code: 1st two digits represent significant figures 3rd digit represents multiplier (number of zeros to follow)	Capacitance Tolerance M = ±20% K = ±10% J = ±5%	Voltage Code 004 = 4Vdc 006 = 6Vdc 010 = 10Vdc 020 = 20Vdc	Standard or Low ESR Range C = Std ESR L = Low ESR	Packaging B = Bulk R = 7" T&R W = Waffle See page 8 for additional packaging options.	Inspection Level L = Group A	Reliability Grade Weibull: C = 0.01%/1000 hrs. 90% conf.	Qualification Level 9 = SRC9000	Termination Finish 0 = Fused Solder Plated 9 = Gold Plated	Surge Test Option 45 = 10 cycles, -55°C & +85°C before Weibull GC = Group C Testing and Data OR = TOR compliant testing and data

For RoHS compliant products, please select correct termination style.

*Contact factory for SRC9000 Space Level SCD details.

TECHNICAL SPECIFICATIONS

Technical Data:	Unless otherwise specified, all technical data relate to an ambient temperature of 25°C				
Capacitance Range:	0.47 μF to 68 μF				
Capacitance Tolerance:	±5%; ±10%; ±20%				
Rated Voltage (V _R)	≤ 85°C:	4	6	10	20
Category Voltage (V _C)	≤ 125°C:	2.7	4	6.7	13.3
Surge Voltage (V _S)	≤ 85°C:	5.3	8	13.3	26.7
Surge Voltage (V _S)	≤ 125°C:	3.5	5.3	8.7	17.8
Temperature Range:	-55°C to +125°C				

TBC SERIES

CWR15 MIL-PRF-55365/12 Established Reliability, COTS-Plus & Space Level



RATING & PART NUMBER REFERENCE				Parametric Specifications by Rating per MIL-PRF-55365/12									Typical RMS Ripple Data by Rating						
				Cap @ 120Hz	DC Rated Voltage	ESR @ 100kHz	DCL max			DF Max			Power Dissipation	25°C Ripple	85°C Ripple	125°C Ripple	25°C Ripple	85°C Ripple	125°C Ripple
							+25°C	+85°C	+125°C	+25°C	+(85/125)°C	-55°C							
CWR15 P/N	MIL & COTS-Plus P/N	SRC9000 P/N	Case	µF @ 25°C	V @ +85°C	Ohms @ +25°C	(µA)	(µA)	(µA)	(%)	(%)	(%)	W	A (100kHz)	A (100kHz)	A (100kHz)	V (100kHz)	V (100kHz)	V (100kHz)
CWR15CK685**L+	TBCL 685*004C□#@0^+	TBCL 685*004C□LC9^+	L	6.8	4	10	0.5	5	6	8	16	12	0.025	0.05	0.05	0.02	0.50	0.45	0.20
CWR15CK106**R+	TBCR 106*004C□#@0^++	TBCR 106*004C□LC9^++	R	10	4	6	0.5	5	6	8	16	12	0.045	0.09	0.08	0.03	0.52	0.47	0.21
CWR15CK156**R+	TBCR 156*004C□#@0^++	TBCR 156*004C□LC9^++	R	15	4	6	0.6	6	7	8	16	12	0.045	0.09	0.08	0.03	0.52	0.47	0.21
CWR15CK226**R+	TBCR 226*004C□#@0^+	TBCR 226*004C□LC9^+	R	22	4	6	0.9	9	11	8	16	12	0.045	0.09	0.08	0.03	0.52	0.47	0.21
CWR15CK336**R+	TBCR 336*004C□#@0^+	TBCR 336*004C□LC9^+	R	33	4	6	1.3	13	16	10	20	15	0.045	0.09	0.08	0.03	0.52	0.47	0.21
CWR15CK686**A+	TBCA 686*004C□#@0^+	TBCA 686*004C□LC9^+	A	68	4	1	2.7	27	33	15	30	23	0.040	0.20	0.18	0.08	0.20	0.18	0.08
CWR15DK335**L+	TBCL 335*006C□#@0^+	TBCL 335*006C□LC9^+	L	3.3	6	10	0.5	5	6	6	12	9	0.025	0.05	0.05	0.02	0.50	0.45	0.20
CWR15DK475**L+	TBCL 475*006C□#@0^+	TBCL 475*006C□LC9^+	L	4.7	6	10	0.5	5	6	8	16	12	0.025	0.05	0.05	0.02	0.50	0.45	0.20
CWR15DK685**R+	TBCR 685*006C□#@0^++	TBCR 685*006C□LC9^++	R	6.8	6	6	0.5	5	6	8	16	12	0.045	0.09	0.08	0.03	0.52	0.47	0.21
CWR15DK106**R+	TBCR 106*006C□#@0^++	TBCR 106*006C□LC9^++	R	10	6	6	0.6	6	7	8	16	12	0.045	0.09	0.08	0.03	0.52	0.47	0.21
CWR15DK156**R+	TBCR 156*006C□#@0^+	TBCR 156*006C□LC9^+	R	15	6	6	0.9	9	11	8	16	12	0.045	0.09	0.08	0.03	0.52	0.47	0.21
CWR15DK226**A+	TBCA 226*006C□#@0^+	TBCA 226*006C□LC9^+	A	22	6	6	1.4	14	17	10	20	15	0.040	0.08	0.07	0.03	0.49	0.44	0.20
CWR15DK336**A+	TBCA 336*006C□#@0^+	TBCA 336*006C□LC9^+	A	33	6	6	2	20	24	10	20	15	0.040	0.08	0.07	0.03	0.49	0.44	0.20
CWR15DK476**A+	TBCA 476*006C□#@0^+	TBCA 476*006C□LC9^+	A	47	6	4	2.8	28	34	15	30	23	0.040	0.10	0.09	0.04	0.40	0.36	0.16
CWR15FK474**L+	TBCL 474*010C□#@0^+	TBCL 474*010C□LC9^+	L	0.47	10	12	0.5	5	6	6	12	9	0.025	0.05	0.04	0.02	0.55	0.49	0.22
CWR15FK684**L+	TBCL 684*010C□#@0^+	TBCL 684*010C□LC9^+	L	0.68	10	10	0.5	5	6	6	12	9	0.025	0.05	0.05	0.02	0.50	0.45	0.20
CWR15FK105**L+	TBCL 105*010C□#@0^+	TBCL 105*010C□LC9^+	L	1	10	10	0.5	5	6	6	12	9	0.025	0.05	0.05	0.02	0.50	0.45	0.20
CWR15FK155**L+	TBCL 155*010C□#@0^+	TBCL 155*010C□LC9^+	L	1.5	10	10	0.5	5	6	6	12	9	0.025	0.05	0.05	0.02	0.50	0.45	0.20
CWR15FK225**L+	TBCL 225*010C□#@0^+	TBCL 225*010C□LC9^+	L	2.2	10	10	0.5	5	6	6	12	9	0.025	0.05	0.05	0.02	0.50	0.45	0.20
CWR15FK335**R+	TBCR 335*010C□#@0^+	TBCR 335*010C□LC9^+	R	3.3	10	6	0.5	5	6	8	16	12	0.045	0.09	0.08	0.03	0.52	0.47	0.21
CWR15FK475**R+	TBCR 475*010C□#@0^+	TBCR 475*010C□LC9^+	R	4.7	10	6	0.5	5	6	8	16	12	0.045	0.09	0.08	0.03	0.52	0.47	0.21
CWR15FK685**R+	TBCR 685*010C□#@0^+	TBCR 685*010C□LC9^+	R	6.8	10	6	0.7	7	8.5	8	16	12	0.045	0.09	0.08	0.03	0.52	0.47	0.21
CWR15FK106**R+	TBCR 106*010C□#@0^+	TBCR 106*010C□LC9^+	R	10	10	6	1	10	12	8	16	12	0.045	0.09	0.08	0.03	0.52	0.47	0.21
CWR15FK156**A+	TBCA 156*010C□#@0^+	TBCA 156*010C□LC9^+	A	15	10	6	1.5	15	18	10	20	15	0.040	0.08	0.07	0.03	0.49	0.44	0.20
CWR15JK474**L+	TBCL 474*020C□#@0^+	TBCL 474*020C□LC9^+	L	0.47	20	24	0.5	5	6	6	12	9	0.025	0.03	0.03	0.01	0.77	0.70	0.31

All technical data relates to an ambient temperature of +25°C. Capacitance and DF are measured at 120Hz, 0.5V RMS with a maximum DC bias of 2.2 volts. DCL is measured at rated voltage after 5 minutes.

NOTE: KYOCERA AVX reserves the right to supply a higher voltage rating or tighter tolerance part in the same case size, to the same reliability standards.

TBC SERIES

TBC COTS-Plus

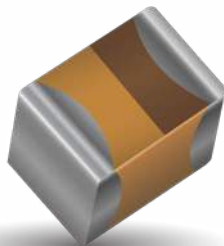

TBC COTS-Plus series extends the range of CWR15. TBC is available with Weibull grade “B” reliability and all MIL-PRF-55365 Rev. G surge test options (“A”, “B” & “C”).

For Space Level applications, SRC9000 ratings are available as shown in the rating table.

There are three termination finishes available: fused solder plated, gold plated, and 100% tin.

For moisture sensitivity levels please refer to the High Reliability Tantalum MSL section located in the back of the High Reliability Tantalum Catalog.

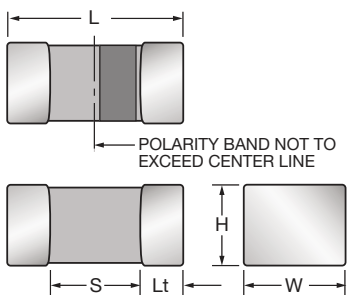

CASE DIMENSIONS:

millimeters (inches)

Code	EIA Code	EIA Metric	Length (L)	Width (W)	Height (H)	Termination Spacing(S)	Minimum Termination Length (Lt)	Average Mass
A	1206	3216-18	3.20 ±0.20 (0.126 ±0.008)	1.60 ±0.20 (0.063 ±0.008)	1.60 ±0.20 (0.063 ±0.008)	1.80 min. (0.071 min.)	0.15 (0.006)	44.6mg
L	0603	1608-10	1.60 ^{+0.25} / _{-0.15} (0.063 ^{+0.010} / _{-0.006})	0.84 ^{+0.20} / _{-0.10} (0.033 ^{+0.008} / _{-0.004})	0.84 ^{+0.20} / _{-0.10} (0.033 ^{+0.008} / _{-0.004})	0.55 min. (0.022 min.)	0.15 (0.006)	8.6mg
R	0805	2012-15	2.00 ^{+0.25} / _{-0.15} (0.079 ^{+0.010} / _{-0.006})	1.35 ^{+0.20} / _{-0.10} (0.053 ^{+0.008} / _{-0.004})	1.35 ^{+0.20} / _{-0.10} (0.053 ^{+0.008} / _{-0.004})	0.70 min. (0.027 min.)	0.15 (0.006)	29.9mg

MARKING

A, L, R CASE

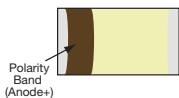

CAPACITANCE AND RATED VOLTAGE, VR (VOLTAGE CODE) RANGE (LETTER DENOTES CASE SIZE)

Capacitance		Voltage Rating DC (V _R) at 85°C					
µF	Code	4V	6V	10V	16V	20V	25V
0.33	334						L
0.47	474			L	L	L	
0.68	684			L	L		
1.0	105			L			
1.5	155			L			
2.2	225			L			
3.3	335			R		R	
4.7	475		L	R	R		
6.8	685		R	R			
10	106	R	R	R	A		
15	156	R		A			
22	226	R	A				
33	336	R	A				
47	476		A				
68	686	A					

TBC SERIES

TBC COTS-Plus

HOW TO ORDER

COTS-PLUS:

TBC	L	685	*	004	C		#	@	0	^	++
Type	Case Size	Capacitance Code pF code: 1st two digits represent significant figures 3rd digit represents multiplier (number of zeros to follow)	Capacitance Tolerance M = ±20% K = ±10% J = ±5%	Voltage Code 004 = 4Vdc 006 = 6Vdc 010 = 10Vdc 016 = 16Vdc 020 = 20Vdc 025 = 25Vdc	ESR C = Std ESR	Packaging B = Bulk R = 7" T&R W = Waffle See page 8 for additional packaging options.	Inspection Level S = Std. Conformance L = Group A	Reliability Grade Weibull: B = 0.1%/1000 hrs. 90% conf. C = 0.01%/1000 hrs. 90% conf. D = 0.001%/1000 hrs. 90% conf. Z = Non-ER None required	Qualification Level 0 = N/A 9 = SRC9000	Termination Finish 0 = Fused Solder Plated 9 = Gold Plated 7 = Matte Sn (COTS-Plus only) LEAD-FREE LEAD-FREE COMPATIBLE COMPONENT For RoHS compliant products, please select correct termination style.	Surge Test Option 00 = None 23 = 10 Cycles, +25°C 24 = 10 Cycles, -55°C & +85°C 45 = 10 cycles, -55°C & +85°C before Weibull

SPACE LEVEL OPTIONS TO SRC9000*:

TBC	L	685	*	004	C		L	C	9	^	++
Type	Case Size	Capacitance Code pF code: 1st two digits represent significant figures 3rd digit represents multiplier (number of zeros to follow)	Capacitance Tolerance M = ±20% K = ±10% J = ±5%	Voltage Code 004 = 4Vdc 006 = 6Vdc 010 = 10Vdc 016 = 16Vdc 020 = 20Vdc 025 = 25Vdc	Standard or Low ESR Range C = Std ESR L = Low ESR	Packaging B = Bulk R = 7" T&R W = Waffle See page 8 for additional packaging options.	Inspection Level L = Group A	Reliability Grade Weibull: C = 0.01%/1000 hrs. 90% conf.	Qualification Level 9 = SRC9000	Termination Finish 0 = Fused Solder Plated 9 = Gold Plated LEAD-FREE LEAD-FREE COMPATIBLE COMPONENT For RoHS compliant products, please select correct termination style.	Surge Test Option 45 = 10 cycles, -55°C & +85°C before Weibull GC = Group C Testing and Data OR = TOR compliant testing and data

*Contact factory for SRC9000 Space Level SCD details.

TECHNICAL SPECIFICATIONS

Technical Data:	All technical data relate to an ambient temperature of +25°C						
Capacitance Range:	0.33 µF to 68 µF						
Capacitance Tolerance:	±5%; ±10%; ±20%						
Leakage Current DCL:	0.01CV or 0.5µA whichever is the greater						
Rated Voltage (V _R)	≤ +85°C:	4	6	10	16	20	25
Category Voltage (V _C)	≤ +125°C:	2.7	4	7	10	13	17
Surge Voltage (V _S)	≤ +85°C:	5.2	8	13	20	26	32
Surge Voltage (V _S)	≤ +125°C:	3.2	5	8	12	16	20
Temperature Range:	-55°C to +125°C						

TBC SERIES

TBC COTS-Plus



RATING & PART NUMBER REFERENCE				Parametric Specifications by Rating										Typical RMS Ripple Data by Rating						
				Cap @ 120Hz	DC Rated Voltage	ESR @ 100kHz	DCL max			DF Max			Power Dissipation	25°C Ripple	85°C Ripple	125°C Ripple	25°C Ripple	85°C Ripple	125°C Ripple	
							+25°C	+85°C	+125°C	+25°C	+(85/125)°C	-55°C								W
P/N	SRC9000 P/N	Case		µF @ 25°C	V @ +85°C	Ohms @ +25°C	(µA)	(µA)	(µA)	(%)	(%)	(%)	W	A (100kHz)	A (100kHz)	A (100kHz)	V (100kHz)	V (100kHz)	V (100kHz)	
4 Volt @ 85°C (2.7 Volt @ 125°C)																				
TBC R 106 * 004 C□# @ 0 ^ ++	TBC R 106 * 004 C□L C 9 ^ ++	0805	R	10	4.0	6	0.5	5.0	6.3	8	16	12	0.045	0.09	0.08	0.03	0.52	0.47	0.21	
TBC R 156 * 004 C□# @ 0 ^ ++	TBC R 156 * 004 C□L C 9 ^ ++	0805	R	15	4.0	6	0.6	6.0	7.5	8	16	12	0.045	0.09	0.08	0.03	0.52	0.47	0.21	
TBC R 226 * 004 C□# @ 0 ^ ++	TBC R 226 * 004 C□L C 9 ^ ++	0805	R	22	4.0	6	0.9	8.8	11.0	15	30	23	0.045	0.09	0.08	0.03	0.52	0.47	0.21	
TBC R 336 * 004 C□# @ 0 ^ ++	TBC R 336 * 004 C□L C 9 ^ ++	0805	R	33	4.0	6	1.3	13.2	16.5	10	20	15	0.045	0.09	0.08	0.03	0.52	0.47	0.21	
TBC A 686 * 004 C□# @ 0 ^ ++	TBC A 686 * 004 C□L C 9 ^ ++	1206	A	68	4.0	1	2.7	27.2	34.0	15	30	23	0.040	0.20	0.18	0.08	0.20	0.18	0.08	
6 Volt @ 85°C (4 Volt @ 125°C)																				
TBC L 475 * 006 C□# @ 0 ^ ++	TBC L 475 * 006 C□L C 9 ^ ++	0603	L	4.7	6	10	0.5	5.0	6.3	8	16	12	0.025	0.05	0.05	0.02	0.50	0.45	0.20	
TBC R 685 * 006 C□# @ 0 ^ ++	TBC R 685 * 006 C□L C 9 ^ ++	0805	R	6.8	6	6	0.5	5.0	6.3	8	16	12	0.045	0.09	0.08	0.03	0.52	0.47	0.21	
TBC R 106 * 006 C□# @ 0 ^ ++	TBC R 106 * 006 C□L C 9 ^ ++	0805	R	10	6	6	0.6	6.3	7.9	8	16	12	0.045	0.09	0.08	0.03	0.52	0.47	0.21	
TBC A 226 K 006 C□# @ 0 ^ ++	TBC A 226 K 006 C□L C 9 ^ ++	1206	A	22	6	6	1.4	13.9	17.3	10	20	15	0.040	0.08	0.07	0.03	0.49	0.44	0.20	
TBC A 336 K 006 C□# @ 0 ^ ++	TBC A 336 K 006 C□L C 9 ^ ++	1206	A	33	6	6	2.1	20.8	26.0	10	20	15	0.040	0.08	0.07	0.03	0.49	0.44	0.20	
TBC A 476 * 006 C□# @ 0 ^ ++	TBC A 476 * 006 C□L C 9 ^ ++	1206	A	47	6	1	3.0	29.6	37.0	15	30	23	0.040	0.20	0.18	0.08	0.20	0.18	0.08	
10 Volt @ 85°C (7 Volt @ 125°C)																				
TBC L 474 * 010 C□# @ 0 ^ ++	TBC L 474 * 010 C□L C 9 ^ ++	0603	L	0.47	10	12	0.5	5.0	6.3	6	12	9	0.025	0.05	0.04	0.02	0.55	0.49	0.22	
TBC L 684 * 010 C□# @ 0 ^ ++	TBC L 684 * 010 C□L C 9 ^ ++	0603	L	0.68	10	10	0.5	5.0	6.3	6	12	9	0.025	0.05	0.05	0.02	0.50	0.45	0.20	
TBC L 105 * 010 C□# @ 0 ^ ++	TBC L 105 * 010 C□L C 9 ^ ++	0603	L	1.0	10	10	0.5	5.0	6.3	6	12	9	0.025	0.05	0.05	0.02	0.50	0.45	0.20	
TBC L 155 * 010 C□# @ 0 ^ ++	TBC L 155 * 010 C□L C 9 ^ ++	0603	L	1.5	10	10	0.5	5.0	6.3	6	12	9	0.025	0.05	0.05	0.02	0.50	0.45	0.20	
TBC L 225 * 010 C□# @ 0 ^ ++	TBC L 225 * 010 C□L C 9 ^ ++	0603	L	2.2	10	10	0.5	5.0	6.3	6	12	9	0.025	0.05	0.05	0.02	0.50	0.45	0.20	
TBC R 335 * 010 C□# @ 0 ^ ++	TBC R 335 * 010 C□L C 9 ^ ++	0805	R	3.3	10	6	0.5	5.0	6.3	8	16	12	0.045	0.09	0.08	0.03	0.52	0.47	0.21	
TBC R 475 * 010 C□# @ 0 ^ ++	TBC R 475 * 010 C□L C 9 ^ ++	0805	R	4.7	10	6	0.5	4.7	5.9	8	16	12	0.045	0.09	0.08	0.03	0.52	0.47	0.21	
TBC R 685 * 010 C□# @ 0 ^ ++	TBC R 685 * 010 C□L C 9 ^ ++	0805	R	6.8	10	6	0.7	6.8	8.5	8	16	12	0.045	0.09	0.08	0.03	0.52	0.47	0.21	
TBC R 106 * 010 C□# @ 0 ^ ++	TBC R 106 * 010 C□L C 9 ^ ++	0805	R	10	10	6	1.0	10.0	12.5	8	16	12	0.045	0.09	0.08	0.03	0.52	0.47	0.21	
TBC A 156 * 010 C□# @ 0 ^ ++	TBC A 156 * 010 C□L C 9 ^ ++	1206	A	15	10	6	1.5	15.0	18.8	10	20	15	0.040	0.08	0.07	0.03	0.49	0.44	0.20	
16 Volt @ 85°C (10 Volt @ 125°C)																				
TBC L 474 * 016 C□# @ 0 ^ ++	TBC L 474 * 016 C□L C 9 ^ ++	0603	L	0.47	16	10	0.5	5.0	6.3	6	12	9	0.025	0.05	0.05	0.02	0.50	0.45	0.20	
TBC L 684 * 016 C□# @ 0 ^ ++	TBC L 684 * 016 C□L C 9 ^ ++	0603	L	0.68	16	10	0.5	5.0	6.3	6	12	9	0.025	0.05	0.05	0.02	0.50	0.45	0.20	
TBC R 475 * 016 C□# @ 0 ^ ++	TBC R 475 * 016 C□L C 9 ^ ++	0805	R	4.7	16	6	0.8	7.5	9.0	10	20	15	0.045	0.09	0.08	0.03	0.52	0.47	0.21	
TBC A 106 * 016 C□# @ 0 ^ ++	TBC A 106 * 016 C□L C 9 ^ ++	1206	A	10	16	3	1.6	16.0	19.2	8	16	12	0.040	0.12	0.10	0.05	0.20	0.18	0.08	
20 Volt @ 85°C (13 Volt @ 125°C)																				
TBC L 474 * 020 C□# @ 0 ^ ++	TBC L 474 * 020 C□L C 9 ^ ++	0603	L	0.47	20	24	0.5	5.0	6.3	6	12	9	0.025	0.03	0.03	0.01	0.77	0.70	0.31	
TBC R 335 * 020 C□# @ 0 ^ ++	TBC R 335 * 020 C□L C 9 ^ ++	0805	R	3.3	20	6	0.7	6.6	8.3	8	16	12	0.045	0.09	0.08	0.03	0.52	0.47	0.21	
25 Volt @ 85°C (17 Volt @ 125°C)																				
TBC L 334 M 025 C□# @ 0 ^ ++	TBC L 334 M 025 C□L C 9 ^ ++	0603	L	0.33	25	30	0.5	5.0	6.3	6	12	9	0.025	0.03	0.03	0.01	0.87	0.78	0.35	

All technical data relates to an ambient temperature of +25°C. Capacitance and DF are measured at 120Hz, 0.5V RMS with a maximum DC bias of 2.2 volts. DCL is measured at rated voltage after 5 minutes.

NOTE: KYOCERA AVX reserves the right to supply a higher voltage rating or tighter tolerance part in the same case size, to the same reliability standards.



The Important Information/Disclaimer is incorporated in the catalog where these specifications came from or available online at www.kyocera-avx.com/disclaimer/ by reference and should be reviewed in full before placing any order.

TBC SERIES

HRC5000 Medical Implantable Grade



The TBC HRC5000 Medical Grade series is designed for use in medical implantable applications. These are some of the smallest surface mount tantalum capacitors available on the market which feature extremely low DC leakage limits well below typical values.



These components are manufactured and tested in the KYOCERA AVX Biddeford Maine factory which is ISO 13485 certified. Weibull grading and surge current testing options per MIL-PRF-55365 are available along with several plating options including tin/lead solder, 100% tin, or gold terminations. To request a specific rating or for more information on HRC5000 testing details please contact the factory.

For moisture sensitivity levels please refer to the High Reliability Tantalum MSL section located in the back of the High Reliability Tantalum Catalog.

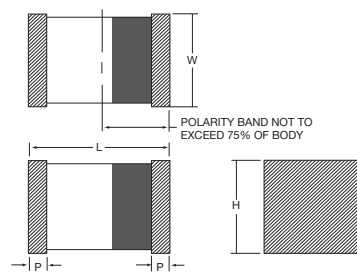

CASE DIMENSIONS: millimeters (inches)

Case Code	EIA Code	Length (L)	Width (W)	Height (H)	Term. Width (P) min.
A	1206	3.20 ±0.20 (0.126 ±0.008)	1.60 ±0.20 (0.063 ±0.008)	1.60 ±0.20 (0.063 ±0.008)	0.15 (0.006)
B	1411	3.60 ±0.20 (0.141 ±0.008)	2.90 ±0.15 (0.114 ±0.006)	1.50 max (0.06 max)	0.15 (0.006)
L	0603	1.60 ^{+0.25} _{-0.15} (0.063 ^{+0.010} _{-0.006})	0.84 ^{+0.20} _{-0.10} (0.033 ^{+0.008} _{-0.004})	0.84 ^{+0.20} _{-0.10} (0.033 ^{+0.008} _{-0.004})	0.15 (0.006)
R	0805	2.00 ^{+0.25} _{-0.15} (0.079 ^{+0.010} _{-0.006})	1.35 ^{+0.20} _{-0.10} (0.053 ^{+0.008} _{-0.004})	1.35 ^{+0.20} _{-0.10} (0.053 ^{+0.008} _{-0.004})	0.15 (0.006)
S	1207	3.20 ±0.20 (0.126 ±0.008)	1.80 ±0.20 (0.071 ±0.008)	1.50 max (0.06 max)	0.15 (0.006)

MARKING

A, B, L, R, S CASE

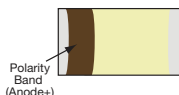

CAPACITANCE AND RATED VOLTAGE, V_R (VOLTAGE CODE) RANGE (LETTER DENOTES CASE SIZE)

Capacitance		Rated Voltage					
μF	Code	4V	6V	10V	16V	20V	40V
0.47	474			L			
0.68	684						
1	105			L		R	A
1.5	155						
2.2	225			L			
3.3	335		L	R			
4.7	475			R	R		
6.8	685			R			
10	106			R	R/A (17v)		
15	156	R					
22	226						
33	336						
47	476		S	B			

TBC SERIES

HRC5000 Medical Implantable Grade

HOW TO ORDER

TBC	R	106	*	010	C	□	L	@	5	^	++
Type	Case Size	Capacitance Code pF code: 1st two digits represent significant figures 3rd digit represents multiplier (number of zeros to follow)	Capacitance Tolerance J = ±5% K = ±10% M = ±20%	Voltage Code 004 = 4Vdc 006 = 6Vdc 010 = 10Vdc 016 = 16Vdc 017 = 17Vdc 020 = 20Vdc 040 = 40Vdc	ESR C = Std ESR	Packaging B = Bulk R = 7" T&R W = Waffle	Inspection Level L = Group A	Reliability Grade Weibull: B = 0.1%/1000 hrs. 90% conf. C = 0.01%/1000 hrs. 90% conf.	Qualification Level 5 = HRC5000	Termination Finish 0 = Solder Fused 9 = Gold Plated 7 = 100% Tin	Surge Test Option 00 = None 23 = 10 Cycles, +25°C 24 = 10 Cycles, -55°C & +85°C 45 = 10 cycles, -55°C & +85°C before Weibull



For RoHS compliant products, please select correct termination style.

*Contact factory for HRC5000 Medical Grade SCD details.

TECHNICAL SPECIFICATIONS

Technical Data:	Unless otherwise specified, all technical data relate to an ambient temperature of 25°C						
Capacitance Range:	0.47 µF to 47 µF						
Capacitance Tolerance:	±5%; ±10%; ±20%						
Rated Voltage (V _R)	≤ +85°C:	4	6	10	16	20	40
Category Voltage (V _C)	≤ +125°C:	2.7	4	6.7	10.7	13.3	26.7
Surge Voltage (V _S)	≤ +85°C:	5.3	8	13.3	20.8	26.7	52
Surge Voltage (V _S)	≤ +125°C:	3.5	5.3	8.7	13.9	17.8	34.7
Temperature Range:	-55°C to +125°C						

TBC SERIES

HRC5000 Medical Implantable Grade



RATING & PART NUMBER REFERENCE		Parametric Specifications by Rating									Typical RMS Ripple Data by Rating						
		Cap @ 120Hz	DC Rated Voltage	ESR @ 100kHz	DCL max			DF Max			Power Dissipation	25°C Ripple Current	85°C Ripple Current	125°C Ripple Current	25°C Ripple Voltage	85°C Ripple Voltage	125°C Ripple Voltage
					+25°C	+85°C	+125°C	+25°C	+(85/125)°C	-55°C							
HRC5000 P/N	Case	µF @ 25°C	V @ +85°C	Ohms @ +25°C	(µA)	(µA)	(µA)	(%)	(%)	(%)	W	A (100kHz)	A (100kHz)	A (100kHz)	V (100kHz)	V (100kHz)	V (100kHz)
TBCR156*004C□L@5 ⁺ ++	R	15	4	6	0.150	1.500	1.800	8	16	12	0.045	0.087	0.078	0.035	0.522	0.468	0.210
TBCL335*006C□L@5 ⁺ ++	L	3.3	6	10	0.100	1.000	1.200	6	12	9	0.025	0.05	0.045	0.02	0.500	0.450	0.200
TBCS476*006C□L@5 ⁺ ++	S	47	6	4	0.470	4.700	5.640	6	8	9	0.04	0.1	0.09	0.04	0.400	0.360	0.160
TBCL474*010C□L@5 ⁺ ++	L	0.47	10	12	0.100	1.000	1.200	6	12	9	0.025	0.046	0.041	0.018	0.552	0.492	0.216
TBCL105*010C□L@5 ⁺ ++	L	1	10	10	0.100	1.000	1.200	6	12	9	0.025	0.05	0.045	0.02	0.500	0.450	0.200
TBCL225*010C□L@5 ⁺ ++	L	2.2	10	10	0.100	1.000	1.200	6	12	9	0.025	0.05	0.045	0.02	0.500	0.450	0.200
TBCR335*010C□L@5 ⁺ ++	R	3.3	10	6	0.100	1.000	1.200	8	16	12	0.045	0.087	0.078	0.035	0.522	0.468	0.210
TBCR475*010C□L@5 ⁺ ++	R	4.7	10	6	0.118	1.175	1.410	8	16	12	0.045	0.087	0.078	0.035	0.522	0.468	0.210
TBCR685*010C□L@5 ⁺ ++	R	6.8	10	6	0.170	1.700	2.040	8	16	12	0.045	0.087	0.078	0.035	0.522	0.468	0.210
TBCR106*010C□L@5 ⁺ ++	R	10	10	6	0.250	2.500	3.000	8	16	12	0.045	0.087	0.078	0.035	0.522	0.468	0.210
TBCB476*010C□L@5 ⁺ ++	B	47	10	1	1.175	11.750	14.100	15	30	23	0.04	0.2	0.18	0.08	0.200	0.180	0.080
TBCR475*016C□L@5 ⁺ ++	R	4.7	16	6	0.188	1.880	2.256	8	10	12	0.045	0.087	0.078	0.035	0.522	0.468	0.210
TBCR106*016C□L@5 ⁺ ++	R	10	16	5	0.400	4.000	4.800	10	12	12	0.045	0.095	0.085	0.038	0.475	0.425	0.190
TBCA106*017C□L@5 ⁺ ++	A	10	17	3	0.425	4.250	5.100	8	16	12	0.04	0.115	0.104	0.046	0.345	0.312	0.138
TBCR105*020C□L@5 ⁺ ++	R	1	20	6	0.100	1.000	1.200	8	16	12	0.045	0.087	0.078	0.035	0.522	0.468	0.210
TBCA105*040C□L@5 ⁺ ++	A	1	40	6	0.100	1.000	1.200	8	16	12	0.04	0.082	0.073	0.033	0.492	0.438	0.198

All technical data relates to an ambient temperature of +25°C. Capacitance and DF are measured at 120Hz, 0.5V RMS with a maximum DC bias of 2.2 volts. DCL is measured at rated voltage after 5 minutes.

NOTICE: The specifications set forth herein are subject to change without notice and are typical and may not apply to all applications. KYOCERA AVX does not warrant or guarantee any aspect of the operation or use of any product except as explicitly set forth in the product specification. Unless specifically agreed to in writing. Seller has not tested or certified its products, services or deliverables for use in high risk applications including medical life support, medical device, direct physical patient contact, water treatment, nuclear facilities, weapon systems, mass and air transportation control, flammable environments, or any other potentially life critical uses. By ordering or using KYOCERA AVX products, the user understands and agrees that KYOCERA AVX makes no assurances that the products, services or deliverables are suitable for any high risk uses.

Under no circumstances does Seller warrant or guarantee suitability for any customer design or manufacturing process. Any statements herein are believed to be true, but are presented without warranty of any kind, explicit or implied. Statements concerning use of KYOCERA AVX products are made without any representation that such use is a non-infringing use or is consistent with any regulation. Users should not assume that any or all safety measures are indicated.

NOTE: KYOCERA AVX reserves the right to supply a higher voltage rating or tighter tolerance part in the same case size, to the same reliability standards.

TBC SERIES

HRC6000 Medical Implantable Grade

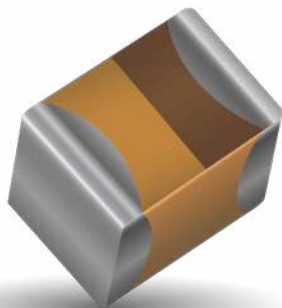

The TBC HRC6000 Medical Grade series is the next generation of our internally qualified medical grade tantalum capacitors. These components are screened using our newly designed Q- Process to effectively remove components that may experience parametric shifts through customer processing or display instability through life testing.



Due to the deficiencies of Weibull grading and its tendency to Burn-In potentially unstable units, this Q-Process utilizes a Product Level Designation system based on a simulated production routine performed on a sample from the population. Once that is completed a calculation is done based on the performance of the sample which can take into account the application conditions of the end customer. This system also allows for derating recommendations to be relaxed as illustrated by the section below.

These components are manufactured and tested in the KYOCERA AVX Biddeford Maine factory which is ISO 13485 certified. For more information on this process or to request a specific rating please contact the factory. In addition, DC leakage testing at application voltage is available upon request.

For additional information on Q-process please consult the KYOCERA AVX technical publication "Reaching the Highest Reliability for Tantalum Capacitors" (see the link: <http://www.avx.com/docs/techinfo/Qprocess.pdf>)

For moisture sensitivity levels please refer to the High Reliability Tantalum MSL section located in the back of the High Reliability Tantalum Catalog.

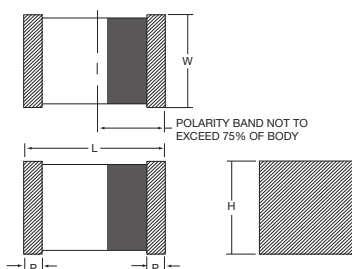

MARKING

A, B, L, R, S CASE

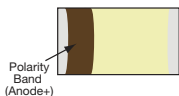

CASE DIMENSIONS: millimeters (inches)

Case Code	EIA Code	Length (L)	Width (W)	Height (H)	Term. Width (P) min.
L	0603	1.60 ^{+0.25} _{-0.15} (0.063 ^{+0.010} _{-0.006})	0.84 ^{+0.20} _{-0.10} (0.033 ^{+0.008} _{-0.004})	0.84 ^{+0.20} _{-0.10} (0.033 ^{+0.008} _{-0.004})	0.15 (0.006)
R	0805	2.00 ^{+0.25} _{-0.15} (0.079 ^{+0.010} _{-0.006})	1.35 ^{+0.20} _{-0.10} (0.053 ^{+0.008} _{-0.004})	1.35 ^{+0.20} _{-0.10} (0.053 ^{+0.008} _{-0.004})	0.15 (0.006)
A	1206	3.20 ±0.20 (0.126 ±0.008)	1.60 ±0.20 (0.063 ±0.008)	1.60 ±0.20 (0.063 ±0.008)	0.15 (0.006)
S	1207	3.20 ±0.20 (0.126 ±0.008)	1.80 ±0.20 (0.071 ±0.008)	1.50 max (0.06 max)	0.15 (0.006)
B	1411	3.60 ±0.20 (0.141 ±0.008)	2.90 ±0.15 (0.114 ±0.006)	1.50 max (0.06 max)	0.15 (0.006)

CAPACITANCE AND RATED VOLTAGE, V_R (VOLTAGE CODE) RANGE (LETTER DENOTES CASE SIZE)

Capacitance		Rated Voltage		
μF	Code	4V	6V	10V
0.33	334			L
0.47	474			L
0.68	684			L
1.0	105			L
2.2	225	L	L	L
3.3	335	L	L	
4.7	475	L	L	
6.8	685	R	R	R
10	106	L, R	R	R
15	156	R	R	
22	226	R	R	
33	336	R, S	S	A, B
47	476	R, S	A, S	A, B
68	686	S	A, B	

TBC SERIES

HRC6000 Medical Implantable Grade

HOW TO ORDER

TBC	R	106	*	010	C	□	L	Q	6	^	++
Type	Case Size	Capacitance Code	Capacitance Tolerance	Voltage Code	ESR	Packaging	Inspection Level	Reliability Grade	Qualification Level	Termination Finish	Custom Option
		pF code: 1st two digits represent significant figures 3rd digit represents multiplier (number of zeros to follow)	J = ±5% K = ±10% M = ±20%	004 = 4Vdc 006 = 6Vdc 010 = 10Vdc	C = Std ESR	B = Bulk R = 7" T&R W = Waffle	L = Group A	Product Level Designator: Q = 0.1%/1000 Hours Minimum, 60% conf.	6 = HRC6000	0 = Solder Fused 9 = Gold Plated 7 = 100% Matte Tin	00 = Std



For RoHS compliant products, please select correct termination style.

*Contact factory for HRC6000 Medical Grade SCD details.

TECHNICAL SPECIFICATIONS

Technical Data:	Unless otherwise specified, all technical data relate to an ambient temperature of 25°C			
Capacitance Range:	0.33 μF to 68 μF			
Capacitance Tolerance:	±5%; ±10%; ±20%			
Rated Voltage (V _R)	≤ +85°C:	4	6	10
Category Voltage (V _C)	≤ +125°C:	2.7	4	6.7
Temperature Range:	-55°C to +125°C			

TBC SERIES

HRC6000 Medical Implantable Grade



RATING & PART NUMBER REFERENCE		Parametric Specifications by Rating									Typical RMS Ripple Data by Rating						
		Cap @ 120Hz	DC Rated Voltage	ESR @ 100kHz	DCL max			DF Max			Power Dissipation	25°C Ripple Current	85°C Ripple Current	125°C Ripple Current	25°C Ripple Voltage	85°C Ripple Voltage	125°C Ripple Voltage
					+25°C	+85°C	+125°C	+25°C	+(85/125)°C	-55°C							
HRC6000 P/N	Case	µF @ 25°C	V @ +85°C	Ohms @ +25°C	(µA)	(µA)	(µA)	(%)	(%)	(%)	W	A (100kHz)	A (100kHz)	A (100kHz)	V (100kHz)	V (100kHz)	V (100kHz)
TBCL225*004C□LQ6***	L	2.2	4	10	0.022	0.22	0.264	6	16	12	0.025	0.050	0.045	0.020	0.500	0.450	0.200
TBCL335*004C□LQ6***	L	3.3	4	10	0.033	0.33	0.396	6	16	12	0.025	0.050	0.045	0.020	0.500	0.450	0.200
TBCL475*004C□LQ6***	L	4.7	4	10	0.047	0.47	0.564	8	16	12	0.025	0.050	0.045	0.020	0.500	0.450	0.200
TBCR685*004C□LQ6***	R	6.8	4	6	0.068	0.68	0.816	8	16	12	0.045	0.087	0.078	0.035	0.520	0.468	0.208
TBCL106*004C□LQ6***	L	10	4	10	0.100	1.00	1.20	8	16	12	0.025	0.050	0.045	0.020	0.500	0.450	0.200
TBCR106*004C□LQ6***	R	10	4	6	0.100	1.00	1.20	8	16	12	0.045	0.087	0.078	0.035	0.520	0.468	0.208
TBCR156*004C□LQ6***	R	15	4	6	0.150	1.50	1.80	8	16	12	0.045	0.087	0.078	0.035	0.520	0.468	0.208
TBCR226*004C□LQ6***	R	22	4	6	0.220	2.20	2.64	8	16	12	0.045	0.087	0.078	0.035	0.520	0.468	0.208
TBCR336*004C□LQ6***	R	33	4	6	0.330	3.30	3.96	10	20	15	0.045	0.087	0.078	0.035	0.520	0.468	0.208
TBCS336*004C□LQ6***	S	33	4	6	0.330	3.30	3.96	8	16	12	0.040	0.082	0.073	0.033	0.490	0.441	0.196
TBCR476*004C□LQ6***	R	47	4	6	0.470	4.70	5.64	10	20	15	0.045	0.087	0.078	0.035	0.520	0.468	0.208
TBCS476*004C□LQ6***	S	47	4	4	0.470	4.70	5.64	8	16	12	0.040	0.100	0.090	0.040	0.400	0.360	0.160
TBCS686*004C□LQ6***	S	68	4	4	0.680	6.80	8.16	15	30	23	0.040	0.100	0.090	0.040	0.400	0.360	0.160
TBCL225*006C□LQ6***	L	2.2	6	10	0.033	0.33	0.396	6	16	12	0.025	0.050	0.045	0.020	0.500	0.450	0.200
TBCL335*006C□LQ6***	L	3.3	6	10	0.050	0.50	0.60	6	12	9	0.025	0.050	0.045	0.020	0.500	0.450	0.200
TBCL475*006C□LQ6***	L	4.7	6	10	0.071	0.71	0.852	8	16	12	0.025	0.050	0.045	0.020	0.500	0.450	0.200
TBCR685*006C□LQ6***	R	6.8	6	6	0.102	1.02	1.224	8	16	12	0.045	0.087	0.078	0.035	0.520	0.468	0.208
TBCR106*006C□LQ6***	R	10	6	6	0.150	1.50	1.80	8	16	12	0.045	0.087	0.078	0.035	0.520	0.468	0.208
TBCR156*006C□LQ6***	R	15	6	6	0.225	2.25	2.70	8	16	12	0.045	0.087	0.078	0.035	0.520	0.468	0.208
TBCR226*006C□LQ6***	R	22	6	6	0.330	3.30	3.96	8	16	12	0.045	0.087	0.078	0.035	0.520	0.468	0.208
TBCS336*006C□LQ6***	S	33	6	6	0.495	4.95	5.94	8	16	12	0.040	0.082	0.073	0.033	0.490	0.441	0.196
TBCA476*006C□LQ6***	A	47	6	4	0.705	7.05	8.46	8	16	12	0.040	0.100	0.090	0.040	0.400	0.360	0.160
TBCS476*006C□LQ6***	S	47	6	4	0.705	7.05	8.46	8	16	12	0.040	0.100	0.090	0.040	0.400	0.360	0.160
TBCA686*006C□LQ6***	A	68	6	4	1.020	10.20	12.24	15	30	22.5	0.040	0.100	0.090	0.040	0.400	0.360	0.160
TBCB686*006C□LQ6***	B	68	6	1	1.020	10.20	12.24	15	30	22.5	0.040	0.200	0.180	0.080	0.200	0.180	0.080
TBCL334*010C□LQ6***	L	0.33	10	12	0.050	0.500	0.600	6	12	9	0.025	0.046	0.041	0.018	0.548	0.493	0.219
TBCL474*010C□LQ6***	L	0.47	10	12	0.050	0.500	0.600	6	12	9	0.025	0.046	0.041	0.018	0.548	0.493	0.219
TBCL684*010C□LQ6***	L	0.68	10	10	0.050	0.500	0.600	6	12	9	0.025	0.050	0.045	0.020	0.500	0.450	0.200
TBCL105*010C□LQ6***	L	1.0	10	10	0.050	0.500	0.600	6	12	9	0.025	0.050	0.045	0.020	0.500	0.450	0.200
TBCL225*010C□LQ6***	L	2.2	10	10	0.055	0.550	0.660	6	12	9	0.025	0.050	0.045	0.020	0.500	0.450	0.200
TBCR685*010C□LQ6***	R	6.8	10	6	0.170	1.70	2.04	8	16	12	0.045	0.087	0.078	0.035	0.520	0.468	0.208
TBCR106*010C□LQ6***	R	10	10	6	0.250	2.50	3.00	8	16	12	0.045	0.087	0.078	0.035	0.520	0.468	0.208
TBCA336*010C□LQ6***	A	33	10	4	0.825	8.25	9.90	15	30	22.5	0.040	0.100	0.090	0.040	0.400	0.360	0.160
TBCB336*010C□LQ6***	B	33	10	1	0.825	8.25	9.90	15	30	22.5	0.040	0.200	0.180	0.080	0.200	0.180	0.080
TBCA476*010C□LQ6***	A	47	10	4	1.175	11.75	14.1	15	30	23	0.040	0.100	0.090	0.040	0.400	0.360	0.160
TBCB476*010C□LQ6***	B	47	10	1	1.175	11.75	14.1	15	30	22.5	0.040	0.200	0.180	0.080	0.200	0.180	0.080

All technical data relates to an ambient temperature of +25°C. Capacitance and DF are measured at 120Hz, 0.5V RMS with a maximum DC bias of 2.2 volts. DCL is measured at rated voltage after 5 minutes.

NOTICE: The specifications set forth herein are subject to change without notice and are typical and may not apply to all applications. KYOCERA AVX does not warrant or guarantee any aspect of the operation or use of any product except as explicitly set forth in the product specification. Unless specifically agreed to in writing, Seller has not tested or certified its products, services or deliverables for use in high risk applications including medical life support, medical device, direct physical patient contact, water treatment, nuclear facilities, weapon systems, mass and air transportation control, flammable environments, or any other potentially life critical uses. By ordering or using KYOCERA AVX products, the user understands and agrees that KYOCERA AVX makes no assurances that the products, services or deliverables are suitable for any high risk uses.

Under no circumstances does Seller warrant or guarantee suitability for any customer design or manufacturing process. Any statements herein are believed to be true, but are presented without warranty of any kind, explicit or implied. Statements concerning use of KYOCERA AVX products are made without any representation that such use is a non-infringing use or is consistent with any regulation. Users should not assume that any or all safety measures are indicated.

NOTE: KYOCERA AVX reserves the right to supply a higher voltage rating or tighter tolerance part in the same case size, to the same reliability standards.

TBC SERIES

HRC6000 Medical Implantable Grade



HRC6000 DERATING GUIDELINES

Due to our new Q-Process test procedures the need for a typical 50% derating of the capacitors rated voltage in application can be relaxed. Below is a table outlining some of the common applications where these components are utilized along with appropriate derating recommendations. When determining the appropriate capacitor voltage rating to utilize, the application voltage is determined by the maximum D.C. voltage with the addition of any A.C. ripple voltage that may be present.

Recommended Derating	Application
20%	Filtering
0%	Pacing
0%	Hold-Up
0%	Charging

T4C HRC4000 Implantable Non Life Support and Non Implantable Life Support

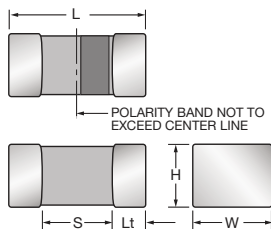
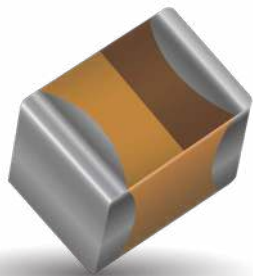

The T4C microchip medical series is designed for use in Implantable - Non-Life support or Non-Implantable - Life support medical applications with space limits. These components are screened using our newly designed Q-Process to effectively remove components that may experience parametric shifts through customer processing or display instability through life testing.

FEATURES

- Dedicated to medical applications
- HRC4000 - Implantable, Non-Life support
- Non-Implantable, Life support
- -55 to +125°C operation temperature
- Basic reliability better than 0.1%/1000hours
- Custom DCL / ESR options on selected parts



For RoHS compliant products, please select correct termination style.

T4C Standard - Standard option DCL and ESR limits including Q-Process screening.

T4C Custom – A custom option where specific DCL and ESR parameter limits can be agreed based Q-Process statistical screening. DCL down to 0.005CV on selected codes

APPLICATIONS

- Medical, Implantable - Non-Life support and Non-Implantable - Life support

For additional information on Q-process please consult the KYOCERA AVX technical publication "Reaching the Highest Reliability for Tantalum Capacitors" (see the link: <http://www.avx.com/docs/techinfo/Qprocess.pdf>)

MARKING

K, L, R CASE

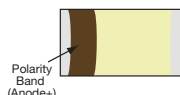

CASE DIMENSIONS: millimeters (inches)

Code	EIA Code	EIA Metric	L+0.20 (0.008) -0.00 (0.000)	W+0.15 (0.006) -0.00 (0.000)	H+0.15 (0.006) -0.00 (0.000)	Termination Spacing(S)	Minimum Termination Length (Lt)
K	0402	1005-07	1.00 (0.039)	0.50 ^{+0.20} _{-0.00} (0.020 ^{+0.008} _{-0.000})	0.50 ^{+0.20} _{-0.00} (0.020 ^{+0.008} _{-0.000})	0.40 (0.016) min	0.10 (0.004)
L	0603	1608-10	1.60 (0.063)	0.85 (0.033)	0.85 (0.033)	0.55 (0.022) min	0.15 (0.006)
R	0805	2012-15	2.00 (0.079)	1.35 (0.053)	1.35 (0.053)	0.70 (0.028) min	0.15 (0.006)

CAPACITANCE AND RATED VOLTAGE RANGE (LETTER DENOTES CASE SIZE)

Capacitance		Rated Voltage DC (V _R) to 85°C (Voltage Code)			
µF	Code	4V (G)	6.3V (J)	10V (A)	16V (C)
0.33	334				
0.47	474			K	
1.0	105	K	K	L	L
2.2	225			L	
3.3	335				
4.7	475	K			
10	106			L ^(M) ,R	
15	156				
22	226		R		

Available Ratings ^(M tolerance only)

Please contact the factory for codes not listed in the table.

Note: Voltage ratings are minimum values. KYOCERA AVX reserves the right to supply higher ratings in the same case size, to the same reliability standards with customer written approval.

T4C HRC4000 Implantable Non Life Support and Non Implantable Life Support

HOW TO ORDER

T4C	R	105	*	006	C		L	Q	4	^	00
Type	Case Size	Capacitance Code	Capacitance Tolerance	Voltage Code	Standard or Low ESR Range	Packaging	Inspection Level	Reliability Grade	Qualification Level	Termination Finish	Suffix
		pF code: 1st two digits represent significant figures 3rd digit represents multiplier (number of zeros to follow)	M = ±20% K = ±10%	004 = 4Vdc 006 = 6.3Vdc 010 = 10Vdc 016 = 16Vdc	C = Std ESR	R, P = 7" Reel X, Q = 4 1/4" Reel B = Bulk	L = Lab Inspection	Q = Q-Process Screening	4 = HRC4000	7 = 100% Tin 9 = Gold Plated H = SnPb Non RoHS H, 9 = (Contact Manufacturer)	00 = Standard XX = Custom

TECHNICAL SPECIFICATIONS

Technical Data:	All technical data relate to an ambient temperature of +25°C				
Capacitance Range:	0.47 µF to 22 µF (for extended range contact manufacturer)				
Capacitance Tolerance:	±10%; ±20%				
Leakage Current DCL:	0.01CV or 0.3µA whichever is the greater				
Rated Voltage (V _R)	≤ +85°C:	4	6.3	10	16
Category Voltage (V _C)	≤ +125°C:	2.7	4	6.7	10
Surge Voltage (V _S)	≤ +85°C:	5.2	8	13	20
Surge Voltage (V _S)	≤ +125°C:	3.2	5	8	13
Temperature Range:	-55°C to +125°C				
Reliability:	0.1% per 1000 hours at 25°C, V _R with 0.1Ω/V series impedance, 90% confidence level				

RATINGS & PART NUMBER REFERENCE

Part No.	Case Size	Capacitance (µF)	Rated Voltage (V)	Rated Temperature (°C)	Category Voltage (V)	Category Temperature (°C)	DCL Max. (µA)	DF Max. (%)	ESR Max. @ 100kHz (Ω)	MSL	100kHz RMS Current (mA)		
											25°C	85°C	125°C
4 Volt @ 85°C													
T4CK105*004C□LQ4*00	K	1	4	85	2.7	125	0.3	6	15	3	32	28	13
T4CK475*004C□LQ4*00	K	4.7	4	85	2.7	125	0.3	20	15	3	32	28	13
6.3 Volt @ 85°C													
T4CK105*006C□LQ4*00	K	1	6.3	85	4	125	0.3	6	15	3	32	28	13
T4CR226*006C□LQ4*00	R	22	6.3	85	4	125	1.4	10	5	3	95	85	38
10 Volt @ 85°C													
T4CK474*010C□LQ4*00	K	0.47	10	85	6.7	125	0.3	6	15	3	32	28	13
T4CL105*010C□LQ4*00	L	1	10	85	6.7	125	0.3	6	7.5	3	58	52	23
T4CL225*010C□LQ4*00	L	2.2	10	85	6.7	125	0.3	6	7.5	3	58	52	23
T4CL106M010C□LQ4*00	L	10	10	85	6.7	125	1	20	7.5	3	58	52	23
T4CR106*010C□LQ4*00	R	10	10	85	6.7	125	1	8	5	3	95	85	38
16 Volt @ 85°C													
T4CL105*016C□LQ4*00	L	1	16	85	10	125	0.3	6	7.5	3	58	52	23

Moisture Sensitivity Level (MSL) is defined according to J-STD-020.

All technical data relates to an ambient temperature of +25°C. Capacitance and DF are measured at 120Hz, 0.5V RMS with a maximum DC bias of 2.2 volts.

DCL is measured at rated voltage after 5 minutes.

The EIA & CECC standards for low ESR Solid Tantalum Capacitors allow an ESR movement to 1.25 times catalogue limit post mounting.

NOTICE: The specifications set forth herein are subject to change without notice and are typical and may not apply to all applications. KYOCERA AVX does not warrant or guarantee any aspect of the operation or use of any product except as explicitly set forth in the product specification. Unless specifically agreed to in writing. Seller has not tested or certified its products, services or deliverables for use in high risk applications including medical life support, medical device, direct physical patient contact, water treatment, nuclear facilities, weapon systems, mass and air transportation control, flammable environments, or any other potentially life critical uses. By ordering or using KYOCERA AVX products, the user understands and agrees that KYOCERA AVX makes no assurances that the products, services or deliverables are suitable for any high risk uses.

Under no circumstances does Seller warrant or guarantee suitability for any customer design or manufacturing process. Any statements herein are believed to be true, but are presented without warranty of any kind, explicit or implied. Statements concerning use of KYOCERA AVX products are made without any representation that such use is a non-infringing use or is consistent with any regulation. Users should not assume that any or all safety measures are indicated.

T4C HRC4000 Implantable Non Life Support and Non Implantable Life Support

QUALIFICATION TABLE

TEST	T4C HRC4000 (Temperature range -55°C to +125°C)										
	Condition			Characteristics							
Endurance	Determine after application of rated voltage for 2000 +48/-0 hours at 85±2°C and then leaving 1-2 hours at room temperature. Also determine of 125°C temperature, category voltage for 2000 +48/-0 hours and then leaving 1-2 hours at room temperature. Power supply impedance to be ≤0.1Ω/V.			Visual examination	no visible damage						
				DCL	1.25 x initial limit						
				ΔC/C	within ±10% of initial value						
				DF	initial limit						
				ESR	1.25 x initial limit						
Storage Life	125°C, 0V, 2000h			Visual examination	no visible damage						
				DCL	1.25 x initial limit						
				ΔC/C	within ±10% of initial value						
				DF	initial limit						
				ESR	1.25 x initial limit						
Temperature Stability	Step	Temperature°C	Duration (min)		+20°C	-55°C	+20°C	+85°C	+125°C	+20°C	
	1	+20±2	15	DCL	IL*	n/a	IL*	10 x IL*	12.5 x IL*	IL*	
	2	-55+0/-3	15	ΔC/C	n/a	+0/-10%	±5%	+10/-0%	+12/-0%	±5%	
	3	+20±2	15	DF	IL*	1.5 x IL*	IL*	1.5 x IL*	2 x IL*	IL*	
	4	+85+3/-0	15	ESR	1.25 x IL*	2.5 x IL*	1.25 x IL*	1.25 x IL*	1.25 x IL*	1.25 x IL*	
	5	+125+3/-0	15								
6	+20±2	15									
Surge Voltage	Test temperature: 85°C+3/0°C Test voltage: Rated voltage at 85°C Surge voltage: 1.3x rated voltage at 85°C Series protection resistance 1000±100Ω Discharge resistance: 1000Ω Number of cycles: 1000x Cycle duration: 6min; 30 sec charge, 5min 30 sec discharge			Visual examination	no visible damage						
				DCL	initial limit						
				ΔC/C	within ±5% of initial value						
				DF	initial limit						
				ESR	1.25 x initial limit						

*Initial Limit

LOT ACCEPTANCE TESTING

TEST	T4C HRC4000 (Temperature range -55°C to +125°C)		
	Condition	Characteristics	
Lot Acceptance Test	25 Pieces from each lot • Read and Record Initial Electricals • Bake Out @ 125°C for 2 Hours • Mount using KYOCERA AVX recommended profile • Read and Record Post Mounting Electricals • Life Test: 6 hours, 2/3 R.V., 125°C • Read and Record Post Electricals	DCL	initial limit
		ΔC/C	within ±5% of initial value
		DF	initial limit
		ESR	1.25 x initial limit
		0 Failures Allowed	

TCB SERIES

COTS-Plus Polymer Capacitor

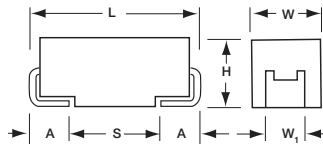

MARKING

B, D, E, Y CASE

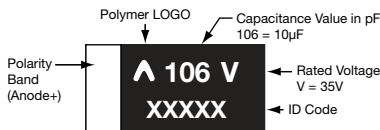

FEATURES

- Robust design for long operation lifetime
- Statistical screening with Accelerated Ageing
- Surge testing level option
- Improved basic reliability 0.5%/1000hrs
- Humidity 85°C/85%RH, Vr, 500/1000 hours
- - 55 to +125°C operation temperature
- Shock and Vibration by MIL-STD-202
- DCL 0.1 CV
- 3x reflow 260°C compatible
- Benign failure mode under recommended use conditions



For RoHS compliant products, please select correct termination style.

APPLICATIONS

Long life time DC/DC converter applications in Telecommunications, Industrial, Avionics.

CASE DIMENSIONS:

millimeters (inches)

Code	EIA Code	EIA Metric	L±0.20 (0.008)	W+0.20 (0.008) -0.10 (0.004)	H+0.20 (0.008) -0.10 (0.004)	W ₁ ±0.20 (0.008)	A+0.30 (0.012) -0.20 (0.008)	S Min.
B	1210	3528-21	3.50 (0.138)	2.80 (0.110)	1.90 (0.075)	2.20 (0.087)	0.80 (0.031)	1.40 (0.055)
D	2917	7343-31	7.30 (0.287)	4.30 (0.169)	2.90 (0.114)	2.40 (0.094)	1.30 (0.051)	4.40 (0.173)
E	2917	7343-43	7.30 (0.287)	4.30 (0.169)	4.10 (0.162)	2.40 (0.094)	1.30 (0.051)	4.40 (0.173)
Y	2917	7343-20	7.30 (0.287)	4.30 (0.169)	2.00 (0.079) max	2.40 (0.094)	1.30 (0.051)	4.40 (0.173)

W₁ dimension applies to the termination width for A dimensional area only.

CAPACITANCE AND RATED VOLTAGE, V_r (VOLTAGE CODE) RANGE (LETTER DENOTES CASE SIZE)

Capacitance		Rated Voltage								
µF	Code	2.5(e)	4V(G)	6.3V(J)	10V(A)	16V(C)	20V(D)	25V(E)	35V(V)	50V(T)
2.2	225									B(300)
4.7	475								B(150,200)	
10	106						B(150)	B(150)	D(70)	D(120)
15	156					B(90)	B(150)	D(70)	D(125)	
22	226			B(70)	B(70)	B(70)	D(70)	D(100)	D(100)	
33	336			B(70)	B(70)	D(70)	D(70)	D(100)	E(65)	
47	476			B(70)	B(70)	D(65)	D(70)	E(50)	E(75)	
68	686			B(70)	D(70)	D(70)		E(60)		
100	107	B(70)	B(70)		D(55)		E(40)			
150	157			D(40)	D(55)	E(25,40)				
220	227		D(40), Y(40)	D(40)	D(35)					
330	337		D(40)	D(40)						
470	477		D(40)							

Released Ratings (ESR ratings in mOhms in parentheses)

Note: Voltage ratings are minimum values. KYOCERA AVX reserves the right to supply higher voltage ratings in the same case size to the same reliability standards

TCB SERIES

COTS-Plus Polymer Capacitor

HOW TO ORDER

PART NUMBER:

TCB	D	107	M	010	C	R	S	Z	0	^	++	E
Type	Case Size See table on previous page	Capacitance Code pF code: 1st two digits represent significant figures 3rd digit represents multiplier (number of zeros to follow)	Tolerance M = ±20%	Rated DC Voltage 002 = 2.5Vdc 004 = 4Vdc 006 = 6.3Vdc 010 = 10Vdc 016 = 16Vdc 020 = 20Vdc 025 = 25Vdc 035 = 35Vdc 050 = 50Vdc	ESR C = Std ESR L = Low ESR	Packaging R = 7" T&R	Inspection Level S = Standard Conformance	Reliability Grade Z = Non-ER	Qualification Level 0 = N/A	Termination Finish 7 = 100% Tin H* = Sn/Pb Non RoHS *Contact Manufacturer	Surge Test Option 00 = Standard 23 = 10x Cycles, 25°C 24 = 10x Cycles, -55°C & +85°C	Additional Character E = Black resin

TECHNICAL SPECIFICATIONS

Technical Data:	All technical data relate to an ambient temperature of +25°C
Capacitance Range:	2.2µF to 470µF
Capacitance Tolerance:	±20%
Leakage Current DCL:	0.1CV
Temperature Range:	-55°C to +125°C
Termination Finish:	Sn Plating or SnPb Plating (Non RoHS)

NOTE: Conductive Polymer Capacitors are designed to operate within the limits of the environmental conditions specified for each series. If operated continuously at their maximum temperature and / or humidity limit, or beyond these limits, capacitors may exhibit a parametric shift in capacitance and increases in ESR. These changes may occur earlier if the specified environmental conditions are exceeded. Similarly, their normal operational time period will be significantly extended if their general duty cycle includes operation below maximum temperature within humidity controlled environments. Careful attention should be paid to maximum temperature with associated high humidity environments as well as voltage derating, ripple current and current surges. Please reference the KYOCERA AVX Conductive Polymer Capacitor Guidelines for more information or contact factory for application assistance.

TCB SERIES

COTS-Plus Polymer Capacitor



RATINGS & PART NUMBER REFERENCE

Part No.	Case Size	Capacitance (µF)	Rated Voltage (V)	Maximum Operating Temperature (°C)	DCL Max. (µA)	DF Max. (%)	ESR Max. @ 100kHz (mΩ)	100kHz RMS Current (mA)				MSL	Humidity 85°C/85%RH, Vr (hrs)
								45°C	85°C	105°C	125°C		
2.5 Volt													
TCBB107M002CRSZ0+++E	B	100	2.5	125	25	8	70	1300	900	600	300	3	1000
4 Volt													
TCBB107M004CRSZ0+++E	B	100	4	125	40	8	70	1300	900	600	300	3	1000
TCBD227M004CRSZ0+++E	D	220	4	125	88	8	40	2400	1700	1100	600	3	1000
TCBY227M004CRSZ0+++E	Y	220	4	125	88	8	40	2200	1500	1000	600	3	500
TCBD337M004CRSZ0+++E	D	330	4	125	132	8	40	2400	1700	1100	600	3	1000
TCBD477M004CRSZ0+++E	D	470	4	125	188	8	40	2400	1700	1100	600	3	1000
6.3 Volt													
TCBB226M006CRSZ0+++E	B	22	6.3	125	13	8	70	1300	900	600	300	3	1000
TCBB336M006CRSZ0+++E	B	33	6.3	125	19	8	70	1300	900	600	300	3	1000
TCBB476M006CRSZ0+++E	B	47	6.3	125	28	8	70	1300	900	600	300	3	1000
TCBB686M006CRSZ0+++E	B	68	6.3	125	40.8	8	70	1300	900	600	300	3	1000
TCBD157M006CRSZ0+++E	D	150	6.3	125	90	8	40	2400	1700	1100	600	3	1000
TCBD227M006CRSZ0+++E	D	220	6.3	125	132	8	40	2400	1700	1100	600	3	1000
TCBD337M006CRSZ0+++E	D	330	6.3	125	198	8	40	2400	1700	1100	600	3	1000
10 Volt													
TCBB226M010CRSZ0+++E	B	22	10	125	22	8	70	1300	900	600	300	3	1000
TCBB336M010CRSZ0+++E	B	33	10	125	33	8	70	1300	900	600	300	3	1000
TCBB476M010CRSZ0+++E	B	47	10	125	47	8	70	1300	900	600	300	3	1000
TCBD686M010CRSZ0+++E	D	68	10	125	68	8	70	1800	1300	800	500	3	1000
TCBD107M010CRSZ0+++E	D	100	10	125	100	8	55	2000	1400	900	500	3	1000
TCBD157M010CRSZ0+++E	D	150	10	125	150	8	55	2000	1400	900	500	3	1000
TCBD227M010CRSZ0+++E	D	220	10	125	220	8	35	2500	1800	1100	600	3	1000
16 Volt													
TCBB156M016CRSZ0+++E	B	15	16	125	24	8	90	1200	800	500	300	3	1000
TCBB226M016CRSZ0+++E	B	22	16	125	35.2	8	70	1300	900	600	300	3	1000
TCBD336M016CRSZ0+++E	D	33	16	125	52	8	70	1800	1300	800	500	3	1000
TCBD476M016CRSZ0+++E	D	47	16	125	75	8	65	1900	1300	900	500	3	1000
TCBD686M016CRSZ0+++E	D	68	16	125	109	8	70	1800	1300	800	500	3	1000
TCBE157M016LRSZ0+++E	E	150	16	125	240	10	25	3200	2200	1400	800	3	1000
TCBE157M016CRSZ0+++E	E	150	16	125	240	10	40	2500	1800	1100	600	3	1000
20 Volt													
TCBB106M020CRSZ0+++E	B	10	20	125	20	8	150	900	600	400	200	3	1000
TCBB156M020CRSZ0+++E	B	15	20	125	30	8	150	900	600	400	200	3	1000
TCBD226M020CRSZ0+++E	D	22	20	125	44	8	70	1800	1300	800	500	3	1000
TCBD336M020CRSZ0+++E	D	33	20	125	66	8	70	1800	1300	800	500	3	1000
TCBD476M020CRSZ0+++E	D	47	20	125	94	8	70	1800	1300	800	500	3	1000
TCBE107M020CRSZ0+++E	E	100	20	125	200	10	40	2500	1800	1100	600	3	1000
25 Volt													
TCBB106M025CRSZ0+++E	B	10	25	125	25	8	150	900	600	400	200	3	1000
TCBD156M025CRSZ0+++E	D	15	25	125	37	8	70	1800	1300	800	500	3	1000
TCBD226M025CRSZ0+++E	D	22	25	125	55	8	100	1500	1100	700	400	3	1000
TCBD336M025CRSZ0+++E	D	33	25	125	82.5	8	100	1500	1100	700	400	3	1000
TCBE476M025CRSZ0+++E	E	47	25	125	117.5	10	50	2200	1500	1000	600	3	1000
TCBE686M025CRSZ0+++E	E	68	25	125	170	10	60	2000	1400	900	500	3	1000
35 Volt													
TCBB475M035LRSZ0+++E	B	4.7	35	125	16.5	8	150	900	600	400	200	3	1000
TCBB475M035CRSZ0+++E	B	4.7	35	125	16.5	8	200	800	600	400	200	3	1000
TCBD106M035CRSZ0+++E	D	10	35	125	35	8	70	1800	1300	800	500	3	1000
TCBD156M035CRSZ0+++E	D	15	35	125	52.5	8	125	1300	900	600	300	3	1000
TCBD226M035CRSZ0+++E	D	22	35	125	77	8	100	1500	1100	700	400	3	1000
TCBE336M035CRSZ0+++E	E	33	35	125	115.5	10	65	2000	1400	900	500	3	1000
TCBE476M035CRSZ0+++E	E	47	35	125	164.5	10	75	1800	1300	800	500	3	1000
50 Volt													
TCBB225M050CRSZ0+++E	B	2.2	50	125	11	10	300	600	400	300	200	3	1000
TCBD106M050CRSZ0+++E	D	10	50	125	50	10	120	1400	1000	600	400	3	1000

Moisture Sensitivity Level (MSL) is defined according to J-STD-020.

All technical data relates to an ambient temperature of +25°C. Capacitance and DF are measured at 120Hz, 0.5RMS with DC bias of 2.2 volts. DCL is measured at rated voltage after 5 minutes.

ESR allowed to move up to 1.25 times catalog limit post mounting.

NOTE: KYOCERA AVX reserves the rights to supply higher voltage rating or tighter tolerance part in the same case size, to the same reliability standards.

TCB SERIES

COTS-Plus Polymer Capacitor



RECOMMENDED DERATING FACTOR

Voltage and temperature derating as percentage of Vr.

Rated voltage	Operating Temperature		
	≤85°C	105°C	125°C
≤10V	90%	90%	60%
≥16V	80%	80%	54%

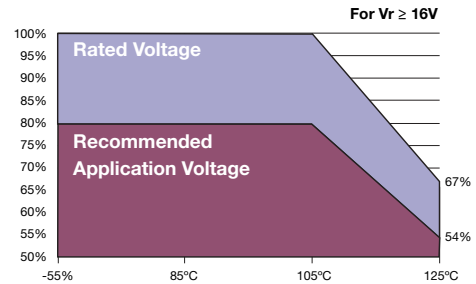
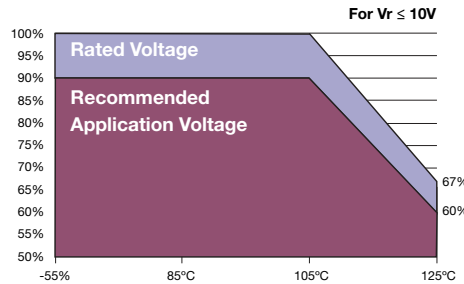

QUALIFICATION TABLE

TEST	TCB series (Temperature range -55°C to +125°C)											
	Condition			Characteristics								
Endurance	Determine after application of rated voltage for 2000 +48/-0 hours at 105±2°C. Also determine after application of 125°C temperature, 2/3 rated voltage for 2000 +48/-0 hours. After test leaving 1-2 hours at room temperature. Power supply impedance to be ≤ 0.1Ω/V.			Visual examination	no visible damage							
				DCL	1.25 x initial limit							
				ΔC/C	within +10/-20% of initial value							
				DF	initial limit							
				ESR	2 x initial limit							
Storage Life	125°C, 0V, 2000h			Visual examination	no visible damage							
				DCL	2 x initial limit							
				ΔC/C	within +10/-20% of initial value							
				DF	initial limit							
				ESR	2 x initial limit							
Biased Humidity	Determine after leaving for 500 or 1000 hours at 85±2°C, 85% relative humidity and rated voltage and then recovery 1-2 hours at room temperature.			Visual examination	no visible damage							
				DCL	3 x initial limit							
				ΔC/C	within +35/-5% of initial value							
				DF	initial limit							
				ESR	2 x initial limit							
Temperature Stability	Step	Temperature°C	Duration (min)		+20°C	-55°C	+20°C	+85°C	+125°C	+20°C		
	1	+20±2	15	DCL	IL*	n/a	IL*	10 x IL*	12.5 x IL*	IL*		
	2	-55±0/-3	15		ΔC/C	n/a	+0/-20%	±5%	+20/-0%	+30/-0%	±5%	
	3	+20±2	15	DF		IL*	1.5 x IL* I	IL*	1.5 x IL*	2 x IL*	IL*	
	4	+85±3/-0	15			ESR	1.25 x initial Limit					
	5	+125±3/-0	15									
6	+20±2	15										
Surge Voltage	Test temperature: 125°C±3/0°C. Surge voltage: 1.3 x 2/3 rated voltage Charge/Discharge resistance: 1000±100Ω Number of cycles: 1000x Cycle duration: 6min; 30 sec charge, 5min 30 sec discharge			Visual examination	no visible damage							
				DCL	initial limit							
				ΔC/C	within +5/-20% of initial value							
				DF	initial limit							
				ESR	1.25 x initial Limit							
Mechanical Shock/Vibration	MIL-STD-202, Method 213, Condition I, 100 G peak MIL-STD-202, Method 204, Condition D, 10 Hz to 2,000 Hz, 20 G peak			Visual examination	no visible damage							
				DCL	initial limit							
				ΔC/C	within ±10% of initial value							
				DF	initial limit							
				ESR	1.25 x initial Limit							

*Initial Limit

For use outside of recommended conditions and special request, please contact manufacturer.
Initial measurement max. 1hr after the removal from dry pack or after pretreatment at 85°C for 24 hours.

TCS SERIES

COTS-Plus & Automotive Polymer Solid Electrolytic Multianode Capacitor



FEATURES

- Robust design for long operation lifetime
- Volumetric efficiency
- Statistical screening with Accelerated Ageing
- Surge testing level option
- Improved basic reliability 0.5%/1000hrs
- Selected codes meet requirements of AEC-Q200
- Humidity 85°C/85%RH, Vr, up to 1000 hours
- -55 to +125°C operation temperature
- Shock and Vibration by MIL-STD-202
- DCL 0.1 CV
- Low ESR
- 3x reflow 260°C compatible
- High frequency capacitance retention
- Benign failure mode under recommended use conditions



MARKING E, U CASE

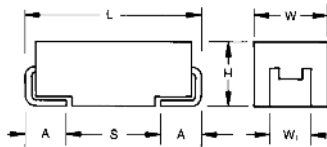
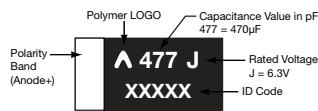

APPLICATIONS

DC/DC converters, Telecommunication (coupling/decoupling), Industrial & special, Automotive (body electronics, cabin controls, infotainment, comfort, after market etc).

Not recommended for use of conductive polymer parts in high power applications. For more information please see the KYOCERA AVX [Automotive Applications Guide](#) at kyocera-avx.com, or contact manufacturer.

KYOCERA AVX's qualification of TCS capacitors meets requirements of AEC-Q200. TCS series is manufactured in an IATF 16949 certified facility.

CASE DIMENSIONS: millimeters (inches)

Code	EIA Code	EIA Metric	L±0.20 (0.008)	W+0.20 (0.008) -0.10 (0.004)	H+0.20 (0.008) -0.10 (0.004)	W1±0.20 (0.008)	A+0.30 (0.012) -0.20 (0.008)	S Min.
E	2917	7343-43	7.30 (0.287)	4.30 (0.169)	4.10 (0.162)	2.40 (0.094)	1.30 (0.051)	4.40 (0.173)
U	2924	7361-43	7.30 (0.287)	6.10 (0.240)	4.10 (0.162)	3.10 (0.122)	1.30 (0.051)	4.40 (0.173)

W1 dimension applies to the termination width for A dimensional area only.

HOW TO ORDER

TCS	E	477	M	006	C	R	S	Z	0	^	++	E
Type	Case Size	Capacitance Code	Tolerance	Rated DC Voltage	ESR Voltage	Packaging	Inspection Level	Reliability Grade	Qualification Level	Termination Finish	Surge Test Option	Additional Character
	See table above	pF code: 1st two digits represent significant figures 3rd digit represents multiplier (number of zeros to follow)	M = ±20%	002 = 2.5Vdc 004 = 4Vdc 006 = 6.3Vdc 010 = 10Vdc 016 = 16Vdc 020 = 20Vdc 025 = 25Vdc 035 = 35Vdc 040 = 40Vdc 050 = 50Vdc	C = Std ESR L = Low ESR	R = 7" T&R	S = Standard Conformance	Z = Non-ER	0 = N/A	7 = 100% Tin H = Sn/Pb Non RoHS	00 = Standard 23 = 10x Cycles, 25°C 24 = 10x Cycles, -55°C & +85°C	E = Black resin

TECHNICAL SPECIFICATIONS

Technical Data:	All technical data relate to an ambient temperature of +25°C
Capacitance Range:	15µF to 1000 µF
Capacitance Tolerance:	±20%
Leakage Current DCL:	0.1CV
Temperature Range:	-55°C to +125°C
Termination Finish:	Sn Plating or SnPb Plating (Non RoHS)
	Selected codes meet requirements of AEC-Q200

NOTE: Conductive Polymer Capacitors are designed to operate within the limits of the environmental conditions specified for each series. If operated continuously at their maximum temperature and / or humidity limit, or beyond these limits, capacitors may exhibit a parametric shift in capacitance and increases in ESR. These changes may occur earlier if the specified environmental conditions are exceeded. Similarly, their normal operational time period will be significantly extended if their general duty cycle includes operation below maximum temperature within humidity controlled environments. Careful attention should be paid to maximum temperature with associated high humidity environments as well as voltage derating, ripple current and current surges. Please reference the KYOCERA AVX Conductive Polymer Capacitor Guidelines for more information or contact factory for application assistance.

TCS SERIES

COTS-Plus & Automotive Polymer Solid Electrolytic Multianode Capacitor



CAPACITANCE AND RATED VOLTAGE RANGE (LETTER DENOTES CASE SIZE)

Capacitance		Rated Voltage DC (VR)									
µF	Code	2.5 (e)	4V (G)	6.3V (J)	10V (A)	16V (C)	20V (D)	25V (E)	35V (V)	40V (G)	50V (T)
15	156										E(100)
22	226										E(75)
33	336							E(60)	E(60)		
47	476							E(60)	E(45, 60)		
68	686						E(25)	E(50)		U(40,50)	
100	107					E(25)	E(25)				
150	157					E(25,40)					
220	227				E(25)	E(25,40)					
330	337			E(15)	E(15,25)	E(15, 25)					
470	477	E(10,12)	E(10,12)	E(10,12)	E(15, 25)						
680	687	E(10,12)	E(10,12)								
1000	108	E(10,12)	E(10,12)								

Released Ratings, (ESR ratings in mOhms in parentheses).

Note: Voltage ratings are minimum values. KYOCERA AVX reserves the right to supply higher ratings in the same case size, to the same reliability standards.

RATINGS & PART NUMBER REFERENCE

Part No.	Case Size	Capacitance (µF)	Rated Voltage (V)	Max Operating Temperature (°C)	DCL Max. (µA)	DF Max. (%)	ESR Max. @ 100kHz (mΩ)	100kHz RMS Current (mA)				MSL	Humidity 85°C/85%RH, Vr (hrs)
								45°C	85°C	105°C	125°C		
2.5 Volt													
TCSE477M002LRSZ0^++E	E	470	2.5	125	117.5	8	10	6400	4500	2900	1600	3	500
TCSE477M002CRSZ0^++E	E	470	2.5	125	117.5	8	12	5800	4100	2600	1500	3	500
TCSE687M002LRSZ0^++E	E	680	2.5	125	170	8	10	6400	4500	2900	1600	3	500
TCSE687M002CRSZ0^++E	E	680	2.5	125	170	8	12	5800	4100	2600	1500	3	500
TCSE108M002LRSZ0^++E	E	1000	2.5	125	250	8	10	6400	4500	2900	1600	3	500
TCSE108M002CRSZ0^++E	E	1000	2.5	125	250	8	12	5800	4100	2600	1500	3	500
4 Volt													
TCSE477M004LRSZ0^++E	E	470	4	125	188	8	10	6400	4500	2900	1600	3	500
TCSE477M004CRSZ0^++E	E	470	4	125	188	8	12	5800	4100	2600	1500	3	500
TCSE687M004LRSZ0^++E	E	680	4	125	272	8	10	6400	4500	2900	1600	3	500
TCSE687M004CRSZ0^++E	E	680	4	125	272	8	12	5800	4100	2600	1500	3	500
TCSE108M004LRSZ0^++E	E	1000	4	125	400	8	10	6400	4500	2900	1600	3	500
TCSE108M004CRSZ0^++E	E	1000	4	125	400	8	12	5800	4100	2600	1500	3	500
6.3 Volt													
TCSE337M006CRSZ0^++E	E	330	6.3	125	198	8	15	5200	3600	2300	1300	3	500
TCSE477M006LRSZ0^++E	E	470	6.3	125	282	8	10	6400	4500	2900	1600	3	500
TCSE477M006CRSZ0^++E	E	470	6.3	125	282	8	12	5800	4100	2600	1500	3	500
10 Volt													
TCSE227M010CRSZ0^++E	E	220	10	125	220	8	25	4000	2800	1800	1000	3	500
TCSE337M010LRSZ0^++E	E	330	10	125	330	8	15	5200	3600	2300	1300	3	500
TCSE337M010CRSZ0^++E	E	330	10	125	330	8	25	4000	2800	1800	1000	3	500
TCSE477M010LRSZ0^++E	E	470	10	125	470	10	15	5200	3600	2300	1300	3	500
TCSE477M010CRSZ0^++E	E	470	10	125	470	10	25	4000	2800	1800	1000	3	500
16 Volt													
TCSE107M016CRSZ0^++E	E	100	16	125	160	8	25	4000	2800	1800	1000	3	500
TCSE157M016LRSZ0^++E	E	150	16	125	240	8	25	4000	2800	1800	1000	3	500
TCSE157M016CRSZ0^++E	E	150	16	125	240	8	40	3200	2200	1400	800	3	500
TCSE227M016LRSZ0^++E	E	220	16	125	352	8	25	4000	2800	1800	1000	3	500
TCSE227M016CRSZ0^++E	E	220	16	125	352	8	40	3200	2200	1400	800	3	500
TCSE337M016LRSZ0^++E	E	330	16	125	528	10	15	5200	3600	2300	1300	3	500
TCSE337M016CRSZ0^++E	E	330	16	125	528	10	25	4000	2800	1800	1000	3	500
20 Volt													
TCSE686M020CRSZ0^++E	E	68	20	125	136	8	25	4000	2800	1800	1000	3	500
TCSE107M020CRSZ0^++E	E	100	20	125	200	8	25	4000	2800	1800	1000	3	500
25 Volt													
TCSE336M025CRSZ0^++E	E	33	25	125	82.5	8	60	2600	1800	1200	700	3	1000
TCSE476M025CRSZ0^++E	E	47	25	125	117.5	8	60	2600	1800	1200	700	3	1000
TCSE686M025CRSZ0^++E	E	68	25	125	170	8	50	2900	2000	1300	700	3	1000
35 Volt													
TCSE226M035CRSZ0^++E	E	22	35	125	77	8	60	2600	1800	1200	700	3	1000
TCSE336M035CRSZ0^++E	E	33	35	125	115.5	8	60	2600	1800	1200	700	3	1000
TCSE476M035LRSZ0^++E	E	47	35	125	164.5	8	45	3000	2100	1400	800	3	1000
TCSE476M035CRSZ0^++E	E	47	35	125	164.5	8	60	2600	1800	1200	700	3	1000
40 Volts													
TCSU686M040LRSZ0^00E	U	68	40	125	272	10	40	3300	2300	1500	800	3	1000
TCSU686M040CRSZ0^00E	U	68	40	125	272	10	50	2900	2000	1300	700	3	1000

Moisture Sensitivity Level (MSL) is defined according to J-STD-020. All technical data relates to an ambient temperature of +25°C. Capacitance and DF are measured at 120Hz, 0.5RMS with DC bias of 2.2 volts. DCL is measured at rated voltage after 5 minutes. ESR allowed to move up to 1.25 times catalog limit post mounting.

NOTE: KYOCERA AVX reserves the right to supply a higher voltage rating or tighter tolerance part in the same case size, to the same reliability standards.



The Important Information/Disclaimer is incorporated in the catalog where these specifications came from or available online at www.kyocera-avx.com/disclaimer/ by reference and should be reviewed in full before placing any order.

TCS SERIES

COTS-Plus & Automotive Polymer Solid Electrolytic Multianode Capacitor



Part No.	Case Size	Capacitance (μF)	Rated Voltage (V)	Max Operating Temperature (°C)	DCL Max. (μA)	DF Max. (%)	ESR Max. @ 100kHz (mΩ)	100kHz RMS Current (mA)				MSL	Humidity 85°C/85%RH, Vr (hrs)
								45°C	85°C	105°C	125°C		
50 Volt													
TCSE156M050CRSZ0 ^{++E}	E	15	50	125	75	10	100	2000	1400	900	500	3	1000
TCSE226M050CRSZ0 ^{++E}	E	22	50	125	110	10	75	2300	1600	1000	600	3	1000

Moisture Sensitivity Level (MSL) is defined according to J-STD-020. All technical data relates to an ambient temperature of +25°C. Capacitance and DF are measured at 120Hz, 0.5RMS with DC bias of 2.2 volts. DCL is measured at rated voltage after 5 minutes. ESR allowed to move up to 1.25 times catalog limit post mounting.
 NOTE: KYOCERA AVX reserves the right to supply a higher voltage rating or tighter tolerance part in the same case size, to the same reliability standards.

RECOMMENDED DERATING FACTOR

Voltage and temperature derating as percentage of Vr.

Rated voltage	Operating Temperature		
	≤85°C	105°C	125°C
≤10V	90%	90%	60%
≥16V	80%	80%	54%

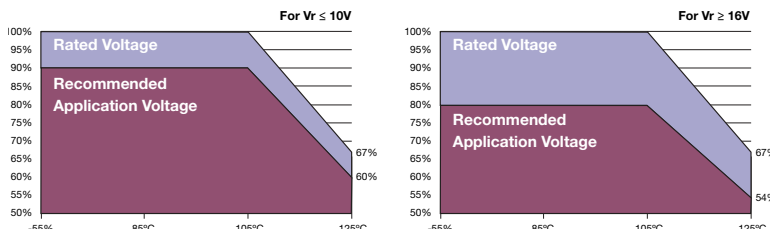

QUALIFICATION TABLE

TEST	TCS COST-Plus series (Temperature range -55°C to +125°C)										
	Condition			Characteristics							
Endurance	Determine after application of rated voltage for 2000 +48/-0 hours at 105±2°C. Also determine after application of 125°C temperature, 2/3 rated voltage for 2000 +48/-0 hours. After test leaving 1-2 hours at room temperature. Power supply impedance to be ≤0.1Ω/V.			Visual examination	no visible damage						
				DCL	1.25 x initial limit						
				ΔC/C	within +10/-20% of initial value						
				DF	initial limit						
				ESR	2 x initial limit						
Storage Life	125°C, 0V, 2000h			Visual examination	no visible damage						
				DCL	2 x initial limit						
				ΔC/C	within +10/-20% of initial value						
				DF	initial limit						
				ESR	2 x initial limit						
Biased Humidity	Determine after leaving for 500 or 1000 hours at 85±2°C, 85% relative humidity and rated voltage and then recovery 1-2 hours at room temperature.			Visual examination	no visible damage						
				DCL	2 x initial limit						
				ΔC/C	within +35/-5% of initial value						
				DF	1.5 x initial limit						
				ESR	2 x initial limit						
Temperature Stability	Step	Temperature°C	Duration (min)		+20°C	-55°C	+20°C	+85°C	+125°C	+20°C	
	1	+20±2	15	DCL	IL*	n/a	IL*	10 x IL*	12.5 x IL*	IL*	
	2	-55+0/-3	15								
	3	+20±2	15	ΔC/C	n/a	+0/-20%	±5%	+20/-0%	+30/-0%	±5%	
	4	+85+3/-0	15	DF	IL*	1.5 x IL*	IL*	1.5 x IL*	1.5 x IL*	IL*	
	5	+125+3/-0	15								
6	+20±2	15									
Surge Voltage	Test temperature: 125°C+3/0°C. Surge voltage: 1.3 x 2/3 rated voltage Charge/Discharge resistance: 1000±100Ω Number of cycles: 1000x Cycle duration: 6min; 30 sec charge, 5min; 30 sec discharge			Visual examination	no visible damage						
				DCL	initial limit						
				ΔC/C	within ±10% of initial value						
				DF	initial limit						
				ESR	1.25 x initial limit						
Mechanical Shock	MIL-STD-202, Method 213, Condition F			Visual examination	no visible damage						
				DCL	initial limit						
				ΔC/C	within ±10% of initial value						
				DF	initial limit						
				ESR	1.25 x initial limit						
Vibration	MIL-STD-202, Method 204, Condition D			Visual examination	no visible damage						
				DCL	initial limit						
				ΔC/C	within ±10% of initial value						
				DF	initial limit						
				ESR	1.25 x initial limit						

*Initial Limit

For use outside of recommended conditions and special request, please contact manufacturer.

Initial measurement max. 1hr after the removal from dry pack or after pretreatment at 85°C for 24 hours.

TCD SERIES

DLA 04051 & COTS-Plus

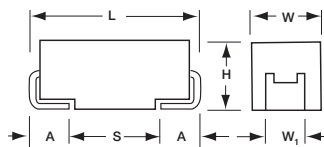

The TCD family is a DLA 04051 / COTS-Plus conductive polymer series designed for use in demanding applications requiring very low ESR with stable, high frequency CAP retention and longer life performance. The series exhibits improved basic reliability of 0.5%/1000hrs at 85°C, and capacitors are designed to withstand biased humidity testing at 85°C/85% R.H. for at least 500 hours, Capacitors are rated for operation up to 125°C and additional surge current screening at -55°C and 85°C optional upon request.

FEATURES

- Statistical electrical screening
- Surge testing level options
- Humidity 85°C/85%R.H., Vr, 500 hours
- -55°C to 125°C operation temperature
- DCL 0.1 CV
- Testing Option A, B
- Life Test at 125°C for 2000 hours
- Vibration
- Surge Voltage & RTSH

MARKING

B, D CASE

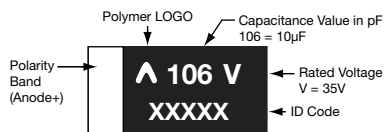

CASE DIMENSIONS: millimeters (inches)

Code	EIA Code	EIA Metric	L±0.20 (0.008)	W+0.20 (0.008) -0.10 (0.004)	H+0.20 (0.008) -0.10 (0.004)	W1±0.20 (0.008)	A+0.30 (0.012) -0.20 (0.008)	S Min.
B	1210	3528-21	3.50(0.138)	2.80 (0.110)	1.90 (0.075)	2.20 (0.087)	0.80 (0.031)	1.40 (0.055)
D	2917	7343-31	7.30 (0.287)	4.30 (0.169)	2.90 (0.114)	2.40 (0.094)	1.30 (0.051)	4.40 (0.173)

CAPACITANCE AND RATED VOLTAGE, LETTER DENOTES CASE SIZE

Capacitance		Rated Voltage DC (Vr) to 105°C						
µF	Code	4V	6.3V	10V	16V	20V	25V	50V
10	106							D (100, 125)
15	156						D (75, 100)	
22	226			B (80)		D (75)		
33	336		B (80)	B (80)		D (75)		
47	476		B (80)		D (65)	D (75)		
68	686		B (80)		D (75)			
100	107	B (80)		D (55)				
150	157			D (55)				
330	337		D (40)					
470	477	D (40)						

Released Ratings (ESR ratings in mOhms in parentheses)

Note: Voltage ratings are minimum values. KYOCERA AVX reserves the right to supply higher voltage ratings in the same case size to the same reliability standards

TCD SERIES

DLA 04051 & COTS-Plus

DLN PN INFORMATION:

04051	-XXX	*	#	+	
Drawing Number	Dash Number See Rating Table	Capacitance Tolerance K = ±10% M = ±20%	Additional Testing option* Z = No Additional Testing A/B = See Features Above	Surge current option Blank = 4 cycles, +25°C Before Aging A = 10 cycles, +25°C B = 10 cycles, -55°C & +85°C	Not RoHS Compliant

*Note: Contact factory regarding availability of additional testing options

HOW TO ORDER KAVX COTS-PLUS PART NUMBER:

TCD	D	107	*	010	C	□	#	Z	0	^	++
Type	Case Size See table above	Capacitance Code pF code: 1st two digits represent significant figures 3rd digit represents multiplier (number of zeros to follow)	Tolerance K = ±10% M = ±20%	Rated DC Voltage 004=4Vdc 006=6.3Vdc 010=10Vdc 016=16Vdc 020=20Vdc 025=25Vdc 050=50Vdc	ESR Voltage C = Std ESR L = Low ESR	Packaging B = Bulk R=7" T&R S=13" T&R W=Waffle	Inspection Level S=Std. Conformance L=Group A D=DSCC	Reliability Grade Z = Non-ER	Qualification Level 0 = N/A	Termination Finish H=Solder Plated 7 = 100% Tin	Surge Test Option 00 = Standard 23=10 Cycles, +25°C 24=10 Cycles, -55°C & +85°C

For RoHS compliant products, please select correct termination style.

TECHNICAL SPECIFICATIONS

Technical Data:	Unless otherwise specified, all technical data relate to an ambient temperature of 25°C							
Capacitance Range:	10 µF to 470 µF							
Capacitance Tolerance:	±10%, ±20%							
Rated Voltage (VR) ≤ 105°C	4	6.3	10	16	20	25	50	
Category Voltage (Vc) ≤ 125°C	2.7	4.2	6.6	10.6	13.4	16.7	33.5	
Surge Voltage (Vs) ≤ 105°C	5.3	8.3	13.2	21.1	26.4	33.0	66.0	
Temperature Range:	-55°C to +125°C							

TCD SERIES

DLA 04051 & COTS-Plus

RATING & PART NUMBER REFERENCE			Parametric Specifications by Rating per MIL-PRF-55365									Typical RMS Ripple Data by Rating				
			Cap @ 120Hz	DC Rated Voltage	ESR @ 100kHz	DCL max			DF Max			Power Dissipation	-55°C to 105°C Ripple Current	125°C Ripple Current	-55°C to 105°C Ripple Voltage	125°C Ripple Voltage
						+25°C	+85°C	+125°C	+25°C	+85°C	+125°C					
04051 Dash No	KAVX COTS-Plus P/N	Case	µF @ 25°C	V @ +105°C	Ohms @ +25°C	(µA)	(µA)	(µA)	(%)	(%)	(%)	W	A (100kHz)	A (100kHz)	V (100kHz)	V (100kHz)
012	TCDB107*004C□#Z0^++	B	100	4	0.08	40	400	400	8	9.6	12	0.125	1.0	0.3	0.08	0.024
016	TCDD477*004C□#Z0^++	D	470	4	0.04	188	1880	1880	10	12	15	0.225	1.9	0.6	0.076	0.024
017	TCDB336*006C□#Z0^++	B	33	6.3	0.08	21	210	210	8	9.6	12	0.125	1.0	0.3	0.08	0.024
019	TCDB476*006C□#Z0^++	B	47	6.3	0.08	30	300	300	8	9.6	12	0.125	1.0	0.3	0.08	0.024
020	TCDB686*006C□#Z0^++	B	68	6.3	0.08	43	430	430	8	9.6	12	0.125	1.0	0.3	0.08	0.024
024	TCDD337*006C□#Z0^++	D	330	6.3	0.04	208	2080	2080	10	12	15	0.225	1.9	0.6	0.076	0.024
025	TCDB226*010C□#Z0^++	B	22	10	0.08	22	220	220	8	9.6	12	0.125	1.0	0.3	0.08	0.024
027	TCDB336*010C□#Z0^++	B	33	10	0.08	33	330	330	8	9.6	12	0.125	1.0	0.3	0.08	0.024
029	TCDD107*010C□#Z0^++	D	100	10	0.055	100	1000	1000	10	12	15	0.225	1.7	0.5	0.094	0.028
031	TCDD157*010C□#Z0^++	D	150	10	0.055	150	1500	1500	10	12	15	0.225	1.7	0.5	0.094	0.028
034	TCDD476*016C□#Z0^++	D	47	16	0.065	76	760	760	10	12	15	0.225	1.5	0.5	0.098	0.033
035	TCDD686*016C□#Z0^++	D	68	16	0.075	109	1090	1090	10	12	15	0.225	1.4	0.5	0.105	0.038
037	TCDD226*020C□#Z0^++	D	22	20	0.075	44	440	440	10	12	15	0.225	1.4	0.5	0.105	0.038
038	TCDB336*020C□#Z0^++	D	33	20	0.075	66	660	660	10	12	15	0.225	1.4	0.5	0.105	0.038
039	TCDD476*020C□#Z0^++	D	47	20	0.075	94	940	940	10	12	15	0.225	1.4	0.5	0.105	0.038
040	TCDD156*025L□#Z0^++	D	15	25	0.075	38	380	380	10	12	15	0.225	1.4	0.5	0.105	0.038
041	TCDD156*025C□#Z0^++	D	15	25	0.1	38	380	380	10	12	15	0.225	1.2	0.4	0.12	0.04
046	TCDD106*050L□#Z0^++	D	10	50	0.1	50	500	500	10	12	15	0.225	1.2	0.4	0.12	0.04
047	TCDD106*050C□#Z0^++	D	10	50	0.125	50	500	500	10	12	15	0.225	1.1	0.4	0.138	0.05

All technical data relates to an ambient temperature of +25°C. Capacitance and DF are measured at 120Hz, 0.5V RMS with a maximum DC bias of 2.2 volts. DCL is measured at rated voltage after 5 minutes.

NOTE: KYOCERA AVX reserves the right to supply a higher voltage rating or tighter tolerance part in the same case size, to the same reliability standards.

RECOMMENDED DERATING FACTOR

Voltage and temperature derating as percentage of Vr.

Rated voltage	Operating Temperature		
	≤85°C	105°C	125°C
≤10V	90%	90%	60%
≥16V	80%	80%	54%

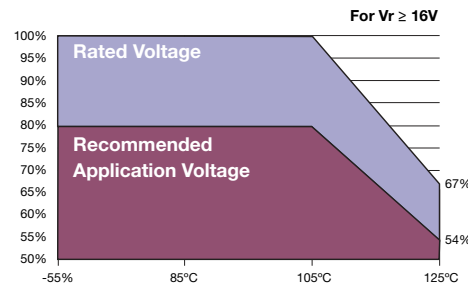
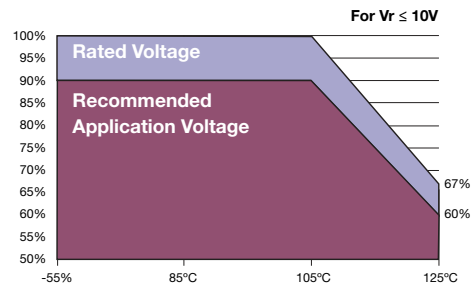

TCS SERIES - QPL ESCC

Polymer Solid Electrolytic Multianode Capacitor



FEATURES

- QPL ESCC approved series
- Manufactured in EU, ESA qualified plant, according to ESCC 3012
- Detailed specification 3012/006
- Robust design for long operation lifetime
- Statistical screening with Accelerated Ageing
- Improved basic reliability 0.5%/1000hrs
- - 55 to +105°C operation temperature
- Low ESR
- CV range 22 - 470µF / 6.3 - 35V



MARKING E CASE

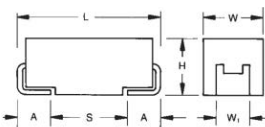
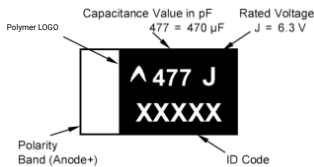

CASE DIMENSIONS: millimeters (inches)

Code	EIA Code	Variant	EIA Metric	L±0.20 (0.008)	W±0.20 (0.008) -0.10 (0.004)	H±0.20 (0.008) -0.10 (0.004)	W1±0.20 (0.008)	A±0.30 (0.012) -0.20 (0.008)	S Min.
E	2917	01	7343-43	7.30 (0.287)	4.30 (0.169)	4.10 (0.162)	2.40 (0.094)	1.30 (0.051)	4.40 (0.173)

W1 dimension applies to the termination width for A dimensional area only.

CAPACITANCE AND RATED VOLTAGE, VR (VOLTAGE CODE) RANGE (LETTER DENOTES CASE SIZE)

Capacitance		Rated voltage DC (VR) to 85°C					
µF	Code	6.3V (J)	10V (A)	16V (C)	20V (D)	25V (E)	35V (V)
22	226						E(50)
33	336					E(50)	
68	686				E(25)		
150	157				E(20)		
220	227		E(15)	E(20)			
330	337	E(12)	E(15)				
470	477	E(12)					

Available Ratings, ESR limited quoted in brackets (mOhms)

HOW TO ORDER PART NUMBER

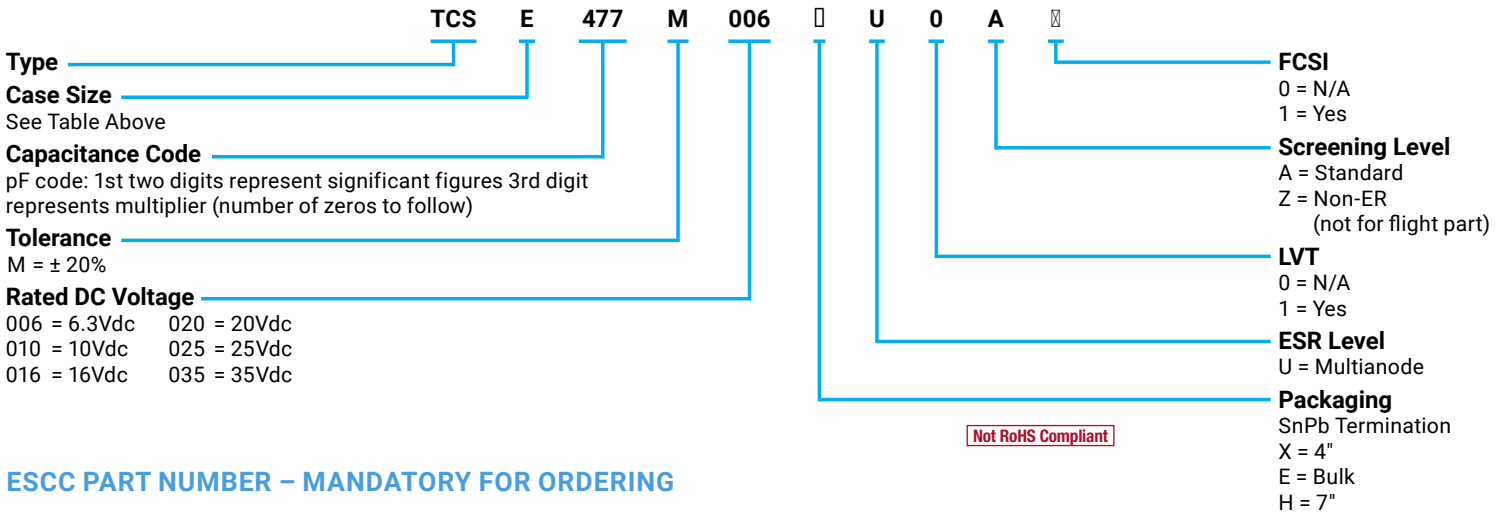

Not RoHS Compliant

ESCC PART NUMBER – MANDATORY FOR ORDERING

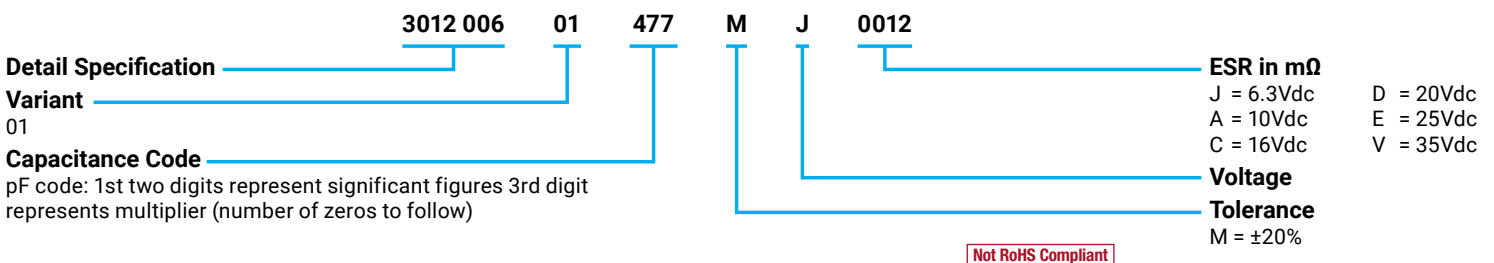

Not RoHS Compliant

TCS SERIES - QPL ESCC

Polymer Solid Electrolytic Multianode Capacitor



OPTION

Packaging: Tape and reel available on request – Contact manufacturer

RATINGS & PART NUMBER REFERENCE

ESCC Part No.	Part No.	Case Size	Capacitance (µF)	Rated Voltage (V)	DCL Max. (µA)	DF Max. (%)	ESR Max. @ 100kHz (mΩ)	100kHz Ripple Current (mA) Ratings			100kHz Ripple Voltage (mV) Ratings		
								45°C	85°C	105°C	45°C	85°C	105°C
6.3 Volt													
301200601337MJ0012	TCSE337M006□U0A [^]	E	330	6.3	198	8	12	5800	4100	2600	70	49	31
301200601477MJ0012	TCSE477M006□U0A [^]	E	470	6.3	282	8	12	5800	4100	2600	70	49	31
10 Volt													
301200601227MA0015	TCSE227M010□U0A [^]	E	220	10	220	8	15	5200	3600	2300	78	54	35
301200601337MA0015	TCSE337M010□U0A [^]	E	330	10	330	8	15	5200	3600	2300	78	54	35
16 Volt													
301200601157MC0020	TCSE157M016□U0A [^]	E	150	16	240	8	20	4500	3200	2000	90	64	40
301200601227MC0020	TCSE227M016□U0A [^]	E	220	16	352	8	20	4500	3200	2000	90	64	40
20 Volt													
301200601686MD0025	TCSE686M020□U0A [^]	E	68	20	136	8	25	4000	2800	1800	100	70	45
25 Volt													
301200601336ME0050	TCSE336M025□U0A [^]	E	33	25	82.5	8	50	2900	2000	1300	145	100	65
35 Volt													
301200601226MV0050	TCSE226M035□U0A [^]	E	22	35	77	8	50	2900	2000	1300	145	100	65

The parts are supplied in dry pack with Moisture Sensitivity Level (MSL) level 3 - defined according to J-STD-020. All technical data relates to an ambient temperature of +25°C. Capacitance and DF are measured at 120Hz, 0.5V RMS with a maximum DC bias of 2.2 volts. DCL is measured at rated voltage after 5 minutes.

NOTE: KYOCERA AVX reserves the right to supply a higher voltage rating or tighter tolerance part in the same case size, to the same reliability standards.

DLA 93026

Wet Electrolytic Tantalum Capacitor

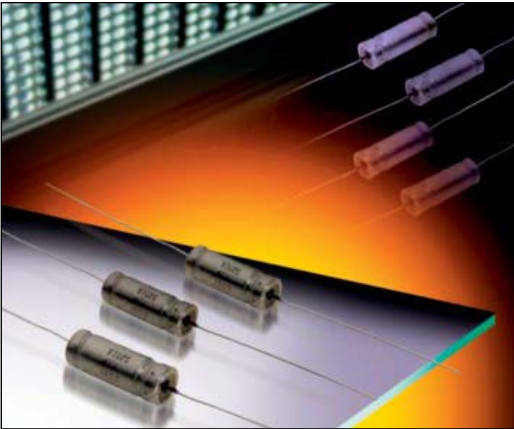

The DLA 93026 series is an axial leaded wet electrolytic tantalum capacitor and represents a new level of high CV (capacitance/voltage) previously unavailable in this technology. These components incorporate a novel, very high capacitance cathode system that allows for higher CV designs, well beyond values specified in the MIL-PRF-39006 drawing.

This design includes a welded tantalum can and header assembly that provides a hermetic seal to withstand harsh shock and vibration requirements of 39006. Wet tantalums do not require the same derating as solid tantalums. KYOCERA AVX recommends derating components by only 20% in order to enhance reliability.

OUTLINE DIMENSIONS

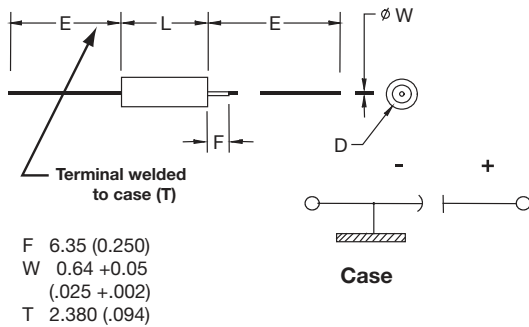

CASE DIMENSIONS: millimeters (inches)

DLA Case Size	Case Size	L +0.79 (0.031) -0.41 (0.016)	D		E ±6.35 (0.250)
			Without Insulating Sleeve ±0.41 (0.016)	With Insulating Sleeve Max	
T1	A	11.51 (0.453)	4.78 (0.188)	5.56 (0.219)	38.10 (1.500)
T2	B	16.28 (0.641)	7.14 (0.281)	7.92 (0.312)	57.15 (2.250)
T3	D	19.46 (0.766)	9.52 (0.375)	10.31 (0.406)	57.15 (2.250)
T4	E	26.97 (1.062)	9.52 (0.375)	10.31 (0.406)	57.15 (2.250)

VOLTAGE RATINGS (Operating Temperature -55°C to 125°C)

Voltage (DC)								
Rated Voltage: (U _r)	85°C	25	30	50	60	75	100	125
Derated Voltage: (U _d)	125°C	15	20	30	40	50	65	85
Surge Voltage: (U _s)	85°C	28.8	34.5	57.5	69	86.3	115	144

DLA 93026

Wet Electrolytic Tantalum Capacitor

HOW TO ORDER DLA 93026 PART NUMBER:

93026

Drawing Number

-XX

Dash Number
See Rating Tables

*

Capacitance Tolerance
K = ±10%
M = ±20%

□

Insulation Sleeve
U = Without Sleeve
S = With Sleeve

Not RoHS Compliant

RIPPLE CURRENT MULTIPLIERS vs. Frequency, temperature and applied voltage^{1/2/}

Frequency of Applied Ripple Current	120Hz				800Hz				1kHz				
	≤55	85	105	125	≤55	85	105	125	≤55	85	105	125	
Ambient Still Air Temperature (°C)													
% of 85°C	100%	0.60	0.39	–	–	0.71	0.43	–	–	0.72	0.45	–	–
Rated	90%	0.60	0.46	–	–	0.71	0.55	–	–	0.72	0.55	–	–
Peak	80%	0.60	0.52	0.35	–	0.71	0.62	0.42	–	0.72	0.62	0.42	–
Voltage	70%	0.60	0.58	0.44	–	0.71	0.69	0.52	–	0.72	0.70	0.52	–
	66-2/3%	0.60	0.60	0.46	0.27	0.71	0.71	0.55	0.32	0.72	0.72	0.55	0.32

Frequency of Applied Ripple Current	10kHz				40kHz				100kHz				
	≤55	85	105	125	≤55	85	105	125	≤55	85	105	125	
Ambient Still Air Temperature (°C)													
% of 85°C	100%	0.88	0.55	–	–	1.00	0.63	–	–	1.10	0.69	–	–
Rated	90%	0.88	0.67	–	–	1.00	0.77	–	–	1.10	0.85	–	–
Peak	80%	0.88	0.76	0.52	–	1.00	0.87	0.59	–	1.10	0.96	0.65	–
Voltage	70%	0.88	0.85	0.64	–	1.00	0.97	0.73	–	1.10	1.07	0.80	–
	66-2/3%	0.88	0.88	0.68	0.40	1.00	1.00	0.77	0.45	1.10	1.10	0.85	0.50

1/ At 125°C the rated voltage of the capacitors decreases to 66 2/3 of the 85°C rated voltage.

2/ The peak of the applied ac ripple voltage plus the applied dc voltage must not exceed the dc voltage rating of the capacitors.

DLA 93026

Wet Electrolytic Tantalum Capacitor



RATINGS & PART NUMBER REFERENCE

DLA Part Number	Cap (µF) 25°C at 120Hz	DC Rated Voltage (V) at 85°C	ESR max (ohms) at 120Hz	DC Leakage max (µA)		Impedance max (Ohms) -55°C at 120Hz	Maximum Capacitance Change (%)			AC Ripple (mA rms) 85°C at 40kHz	Case Size	
				+25°C	+85°C & +125°C		-55°C	+85°C	+125°C		AVX	DLA
25 VDC at 85°C 15 VDC at 125°C												
93026-29*□	120	25	1.3	1	5	25	-42	8	12	1250	A	T1
93026-30*□	560	25	0.83	2	10	12	-65	10	15	2100	B	T2
93026-31*□	1200	25	0.65	5	20	7	-70	12	18	2600	D	T3
93026-32*□	1800	25	0.5	6	25	7	-75	12	20	3100	E	T4
93026-64*□	2200	25	0.5	10	80	10	-90	30	50	3200	E	T4
30 VDC at 85°C 20 VDC at 125°C												
93026-33*□	100	30	1.3	1	5	25	-38	8	12	1200	A	T1
93026-34*□	470	30	0.85	2	10	15	-65	10	18	1800	B	T2
93026-35*□	1000	30	0.7	7	25	7	-70	10	18	2500	D	T3
93026-36*□	1500	30	0.6	12	35	6	-72	10	20	3000	E	T4
50 VDC at 85°C 30 VDC at 125°C												
93026-37*□	68	50	1.5	1	5	35	-25	8	15	1050	A	T1
93026-38*□	220	50	0.9	2	10	17.5	-50	8	15	1800	B	T2
93026-39*□	470	50	0.75	3	25	10	-50	8	15	2100	D	T3
93026-40*□	680	50	0.7	5	40	8	-58	10	20	2750	E	T4
60 VDC at 85°C 40 VDC at 125°C												
93026-41*□	47	60	2	1	5	44	-25	8	12	1050	A	T1
93026-42*□	150	60	1.1	2	10	20	-40	8	15	1650	B	T2
93026-43*□	390	60	0.9	3	25	15	-60	8	15	2100	D	T3
93026-44*□	560	60	0.8	5	40	10	-58	8	15	2750	E	T4
93026-65*□	1000	60	1	12	90	20	-90	30	50	3200	E	T4
75 VDC at 85°C 50 VDC at 125°C												
93026-45*□	33	75	2.5	1	5	66	-25	5	9	1050	A	T1
93026-46*□	110	75	1.3	2	10	24	-35	6	10	1650	B	T2
93026-47*□	330	75	1	3	30	12	-45	6	10	2100	D	T3
93026-48*□	470	75	0.9	5	50	12	-55	6	10	2750	E	T4
100 VDC at 85°C 65 VDC at 125°C												
93026-49*□	15	100	3.5	1	5	125	-18	3	10	1050	A	T1
93026-50*□	68	100	2.1	2	10	37	-30	4	12	1650	B	T2
93026-51*□	150	100	1.6	3	25	22	-35	6	12	2100	D	T3
93026-52*□	220	100	1.2	5	50	15	-40	6	12	2750	E	T4
125 VDC at 85°C 85 VDC at 125°C												
+93026-53*□	10	125	5.5	1	5	175	-15	3	10	1050	A	T1
+93026-54*□	47	125	2.3	2	10	47	-25	5	12	1650	B	T2
93026-55*□	100	125	1.8	3	25	35	-35	5	12	2100	D	T3
93026-56*□	150	125	1.6	5	50	20	-35	6	12	2750	E	T4

+ Contact factory of leadtime and availability

All technical data relates to an ambient temperature of +25°C. Capacitance and DF are measured at 120Hz, 0.5RMS with DC bias of 2.2V. DCL is measured at rated voltage after 5 minutes.

NOTE: KYOCERA AVX reserves the rights to supply higher voltage rating in the same case size, to the same reliability standards.

TWA SERIES

MIL-PRF-39006/33 Series – Military Conventional Wet Tantalum



GENERAL DESCRIPTION

This data sheet contains the MIL-PRF-39006 ratings for which KYOCERA AVX is a qualified approved supplier. This will be continually updated as the qualification expands. This design is an axial leaded tubular case. It includes a welded tantalum can and header assembly that provides a hermetic seal to withstand harsh environments. The 1000 hour failure rates of 1%, 0.1% and 0.01% correspond to "M", "P", and "R" respectively. For details on testing conditions please refer to MIL-PRF-39006.

OUTLINE DIMENSIONS

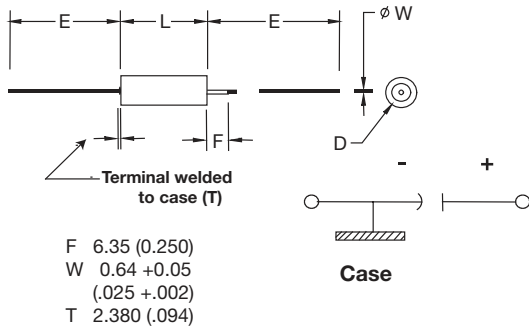

CURRENTLY QUALIFIED M39006 RATINGS INCLUDE T3-T4 CASE SIZE:

	M Level Reliability Dashes	P Level Reliability Dashes
M39006/33	25V-75V	25V-75V

CASE DIMENSIONS: Millimeters (inches)

DLA Case Size	Case Size	L +0.79 (0.031) -0.41 (0.016)	D Basic Case ±0.41 (0.016)	D Insulated Case Max	E ±6.35 (0.250)
T3	D	19.46 (0.766)	9.52 (0.375)	10.31 (0.406)	57.15 (2.250)
T4	E	26.97 (1.062)	9.52 (0.375)	10.31 (0.406)	57.15 (2.250)

VOLTAGE RATINGS (Operating Temperature -55°C to 125°C)

Voltage (DC)												
Rated Voltage: (V _r)	85°C	6	8	10	15	25	30	50	60	75	100	125
Derated Voltage: (V _d)	125°C	4	5	6	10	15	20	30	40	50	65	85
Surge Voltage: (V _s)	85°C	6.9	9.2	11.5	17.3	28.8	34.5	57.5	69	86.3	115	144

HOW TO ORDER MILITARY M39006 PART NUMBER:

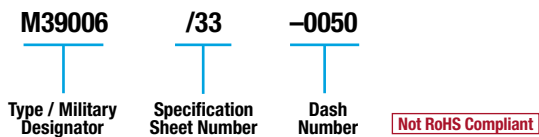

TWA SERIES

MIL-PRF-39006/33 Series – Military Conventional Wet Tantalum



RIPPLE CURRENT MULTIPLIERS vs. Frequency, temperature and applied voltage^{1/2/3/}

Frequency of Applied Ripple Current		120Hz				800Hz				1kHz			
Ambient Still Air Temperature (°C)		≤55	85	105	125	≤55	85	105	125	≤55	85	105	125
% of 85°C Rated Peak Voltage	100%	0.60	0.39	–	–	0.71	0.43	–	–	0.72	0.45	–	–
	90%	0.60	0.46	–	–	0.71	0.55	–	–	0.72	0.55	–	–
	80%	0.60	0.52	0.35	–	0.71	0.62	0.42	–	0.72	0.62	0.42	–
	70%	0.60	0.58	0.44	–	0.71	0.69	0.52	–	0.72	0.70	0.52	–
	66-2/3%	0.60	0.60	0.46	0.27	0.71	0.71	0.55	0.32	0.72	0.72	0.55	0.32

Frequency of Applied Ripple Current		10kHz				40kHz				100kHz			
Ambient Still Air Temperature (°C)		≤55	85	105	125	≤55	85	105	125	≤55	85	105	125
% of 85°C Rated Peak Voltage	100%	0.88	0.55	–	–	1.00	0.63	–	–	1.10	0.69	–	–
	90%	0.88	0.67	–	–	1.00	0.77	–	–	1.10	0.85	–	–
	80%	0.88	0.76	0.52	–	1.00	0.87	0.59	–	1.10	0.96	0.65	–
	70%	0.88	0.85	0.64	–	1.00	0.97	0.73	–	1.10	1.07	0.80	–
	66-2/3%	0.88	0.88	0.68	0.40	1.00	1.00	0.77	0.45	1.10	1.10	0.85	0.50

1/At 125°C the rated voltage of the capacitors decreases to 66 2/3 of the 85°C rated voltage.

2/The peak of the applied ac ripple voltage plus the applied dc voltage must not exceed the dc voltage rating of the capacitors.

3/The ripple current listed in the parametric tables represents a rating calculated by using a maximum internal temperature rise (ΔT) at 50°C at 40 kHz at 85°C ambient temperature, with a maximum peak rated voltage of 66.67 percent of the 85°C peak voltage rating.

CAPACITANCE AND RATED VOLTAGE, V_R (VOLTAGE CODE) RANGE (LETTER DENOTES CASE SIZE)

Capacitance		Rated Voltage DC (V_R) to 85°C				
μF	Code	25V	30V	50V	60V	75V
470	477					E
560	567				E	
680	687			E		
750	757					
1000	108		D			
1200	128	D				
1500	158		E			
1800	188	E				

M39006 /33 RATINGS AND DASH NUMBER REFERENCE

M39006/33 Dashes		Tolerance (%)	Cap (μF) 25°C at 120Hz	DC Rated Voltage (V) at 85°C	DC Leakage max (μA)		DF max (%)	ESR max (Ohms) at 120Hz	Impedance max (Ohms) -55°C at 120Hz	Maximum Capacitance Change (%)			AC Ripple (mA rms) 85°C at 40kHz	Case Size
M Level	P Level				+25°C	+85°C & +125°C				-55°C	+85°C	+125°C		
-0007	-1007	20	1200	25	5	20	70.6	0.65	7	-70	12	18	2600	T3
-0008	-1008	10												
-0009	-1009	20	1800	25	6	25	81.4	0.5	7	-75	12	20	3100	T4
-0010	-1010	10												
-0017	-1017	20	1000	30	7	25	63.3	0.7	7	-70	10	18	2500	T3
-0018	-1018	10												
-0019	-1019	20	1500	30	12	35	81.4	0.6	6	-72	10	20	3000	T4
-0020	-1020	10												
-0029	-1029	20	680	50	5	40	43.1	0.7	10	-58	10	20	2750	T4
-0030	-1030	10												
-0039	-1039	20	560	60	5	40	40.5	0.8	10	-58	8	15	2750	T4
-0040	-1040	10												
-0049	-1049	20	470	75	5	50	38.3	0.9	12	-55	8	12	2750	T4
-0050	-1050	10												

All technical data relates to an ambient temperature of +25°C. Capacitance and DF are measured at 120Hz, 0.5RMS with DC bias of 2.2V.

DCL is measured at rated voltage after 5 minutes.

TWA SERIES

COTS-Plus – Wet Electrolytic Tantalum Capacitor



GENERAL DESCRIPTION

The TWA series is an axial leaded wet electrolytic tantalum capacitor with a unique cathode system that promotes very high CV (Capacitance/Voltage) per cc in traditional MIL-PRF-39006 case sizes.

The series also utilizes a welded tantalum can and header assembly to provide a hermetic seal and subsequent long operating lifetime.

The construction is similar to DLA 93026 with capability of meeting harsh shock and vibration conditions.

OUTLINE DIMENSIONS

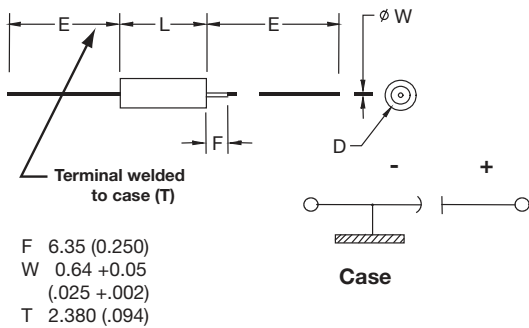

CASE DIMENSIONS: millimeters (inches)

DLA Case Size	Case Size	L +0.79 (0.031) -0.41 (0.016)	D Without Insulating Sleeve ±0.41 (0.016)	D With Insulating Sleeve Max	E ±6.35 (0.250)
T1	A	11.51 (0.453)	4.78 (0.188)	5.56 (0.219)	38.10 (1.500)
T2	B	16.28 (0.641)	7.14 (0.281)	7.92 (0.312)	57.15 (2.250)
T3	D	19.46 (0.766)	9.52 (0.375)	10.31 (0.406)	57.15 (2.250)
T4	E	26.97 (1.062)	9.52 (0.375)	10.31 (0.406)	57.15 (2.250)

VOLTAGE RATINGS (Operating Temperature -55°C to 125°C)

Voltage (DC)									
Rated Voltage: (V_R)	85°C	15	25	30	50	60	75	100	125
Derated Voltage: (V_D)	125°C	10	15	20	30	40	50	65	85
Surge Voltage: (V_S)	85°C	17.3	28.8	34.5	57.5	69	86.3	115	144

HOW TO ORDER PART NUMBER:

TWA	E	407	*	100	□	B	#	Z	0	^	00
Type	Case Size	Capacitance Code pF code: 1st two digits represent significant figures 3rd digit represents multiplier (number of zeros to follow)	Capacitance Tolerance K = ±10% M = ±20%	Voltage Code	Insulation Sleeve C = Without Sleeve S = With Sleeve	Packaging B = Tray Pack	Qualification E = Extended range S = COTS+ L = Group A	Reliability Z = Non-ER	Qualification Level 0 = N/A	Termination Finish 0 = Sn/Pb 60/40 7 = Matte tin	Custom Test Options 00 = Standard 01 = Random vibration*



For RoHS compliant products, please select correct termination style.

* Please contact the factory for additional details and availability.

TWA SERIES

COTS-Plus – Wet Electrolytic Tantalum Capacitor



RIPPLE CURRENT MULTIPLIERS vs. Frequency, temperature and applied voltage^{1/2/}

Frequency of Applied Ripple Current		120Hz				800Hz				1kHz			
Ambient Still Air Temperature (°C)		≤55	85	105	125	≤55	85	105	125	≤55	85	105	125
% of 85°C	100%	0.60	0.39	–	–	0.71	0.43	–	–	0.72	0.45	–	–
	90%	0.60	0.46	–	–	0.71	0.55	–	–	0.72	0.55	–	–
Rated Peak Voltage	80%	0.60	0.52	0.35	–	0.71	0.62	0.42	–	0.72	0.62	0.42	–
	70%	0.60	0.58	0.44	–	0.71	0.69	0.52	–	0.72	0.70	0.52	–
66-2/3%		0.60	0.60	0.46	0.27	0.71	0.71	0.55	0.32	0.72	0.72	0.55	0.32

Frequency of Applied Ripple Current		10kHz				40kHz				100kHz			
Ambient Still Air Temperature (°C)		≤55	85	105	125	≤55	85	105	125	≤55	85	105	125
% of 85°C	100%	0.88	0.55	–	–	1.00	0.63	–	–	1.10	0.69	–	–
	90%	0.88	0.67	–	–	1.00	0.77	–	–	1.10	0.85	–	–
Rated Peak Voltage	80%	0.88	0.76	0.52	–	1.00	0.87	0.59	–	1.10	0.96	0.65	–
	70%	0.88	0.85	0.64	–	1.00	0.97	0.73	–	1.10	1.07	0.80	–
66-2/3%		0.88	0.88	0.68	0.40	1.00	1.00	0.77	0.45	1.10	1.10	0.85	0.50

1/At 125°C the rated voltage of the capacitors decreases to 66 2/3 of the 85°C rated voltage.

2/The peak of the applied ac ripple voltage plus the applied dc voltage must not exceed the dc voltage rating of the capacitors.

CAPACITANCE AND RATED VOLTAGE, V_R (VOLTAGE CODE) RANGE (LETTER DENOTES CASE SIZE)

Capacitance		Rated Voltage DC (VR) to 85°C							
µF	Code	15V	25V	30V	50V	60V	75V	100V	125V
10	106							A ^(M)	A
15	156							A	
22	226							B	
27	276								B
33	336						A		
47	476				B	A			B
68	686		A		A		A ^(M)	B	
82	826								E
100	107			A	A ^(M)	B	B		D
110	117						B		
120	127		A		B				D
150	157				B	B		D	E
220	227			B	B		E	D,E	E
270	277		B						
330	337		B		E		D,E	E	E
390	397	D				D			
400	407							E	
470	477			B	D,E		E	E	E
560	567		B			E		E	E
660	667						E		
680	687		E	D,E	E	E	E		
750	757		D,E	D,E	E	E	E	E	
1000	108		D,E	D,E	D,E	E	E		
1200	128		D		E				
1500	158		E	E	E				
1800	188		E						
2200	228		E			E ^(M)			
3000	308				E				
4700	478		E						
5600	568								

Available Ratings ^(M tolerance only)

TWA SERIES

COTS-Plus – Wet Electrolytic Tantalum Capacitor



RATINGS & PART NUMBER REFERENCE

ENERGY

Part Number	Cap (µF) at 120Hz	DC Rated Voltage (V) at 85°C	ESR max (ohms) at 120Hz	DC Leakage max (µA)		Impedance max (Ohms) -55°C at 120Hz	Maximum Capacitance Change (%)			AC Ripple (mA rms) 85°C at 40kHz	Case Size		Energy (mJ)	Energy / volume (mJ/mm ³)
				+25°C	+85°C & +125°C		-55°C	+85°C	+125°C		KAVX	DLA		
15 Volts														
TWAD397*015□BSZ0*00	390	15	1.7	7	28	48	-70	25	25	1396	D	T3	33.78	0.024
25 Volts														
TWAA686*025□BEZ0*00	68	25	2.5	0.6	3	45	-40	12	15	850	A	T1	13.29	0.064
TWAA127*025□BSZ0000	120	25	1.3	1	5	25	-42	8	12	1250	A	T1	23.46	0.114
TWAA127*025□BEZ0*00*	120	25	2.3	2	10	35	-42	20	25	1250	A	T1	23.46	0.114
TWAB277*025□BEZ0*00	270	25	0.9	4	20	17.5	-50	18	28	1800	B	T2	52.79	0.081
TWAB337*025□BEZ0*00	330	25	1.3	2	20	25	-60	10	15	1550	B	T2	64.52	0.099
TWAB567*025□BSZ0*00	560	25	0.83	2	10	12	-65	10	15	2100	B	T2	109.48	0.168
TWAE687*025□BEZ0*00	680	25	0.75	3	12	12	-50	8	15	2100	E	T4	132.94	0.069
TWAD757*025□BEZ0*00	750	25	1	3	25	15	-50	8	15	2000	D	T3	146.63	0.106
TWAE757*025□BEZ0*00	750	25	0.75	3.5	16	9	-55	10	18	2200	E	T4	146.63	0.076
TWAD108*025□BSZ0*00	1000	25	1	4	30	15	-50	8	15	2300	D	T3	195.50	0.141
TWAE108*025□BEZ0*00	1000	25	0.7	4	20	9	-55	10	18	2400	E	T4	195.50	0.102
TWAD128*025□B#Z0*00	1200	25	0.65	5	20	7	-70	12	18	2600	D	T3	234.60	0.169
TWAE158*025□BEZ0*00	1500	25	0.5	6	24	7	-65	15	20	2850	E	T4	293.25	0.153
TWAE188*025□BSZ0*00	1800	25	0.5	6	25	7	-75	12	20	3100	E	T4	351.90	0.183
TWAE228*025□BSZ0*00	2200	25	0.5	10	80	10	-90	30	50	3200	E	T4	430.10	0.224
TWAE478*025□B#Z0*00	4700	25	0.5	30	180	5	-90	60	80	4250	E	T4	918.85	0.479
30 Volts														
TWAA107*030□BSZ0000	100	30	1.3	1	5	25	-38	8	12	1200	A	T1	28.35	0.137
TWAA107*030□BEZ0*00*	100	30	2.3	2	10	35	-38	20	25	1200	A	T1	28.35	0.137
TWAB227*030□BEZ0*00	220	30	2	1.9	10	40	-40	18	28	1200	B	T2	62.37	0.096
TWAB477*030□BSZ0*00	470	30	0.85	2	10	15	-65	10	18	1800	B	T2	133.25	0.205
TWAD687*030□BEZ0*00	680	30	1	3.3	25	15	-50	8	15	1900	D	T3	192.78	0.139
TWAE687*030□BEZ0*00	680	30	0.8	4.5	18	10	-60	8	15	2100	E	T4	192.78	0.100
TWAD757*030□BEZ0*00	750	30	1	3.6	30	15	-50	8	15	2000	D	T3	212.63	0.154
TWAE757*030□BEZ0*00	750	30	0.8	5	20	10	-65	10	18	2200	E	T4	212.63	0.111
TWAD108*030□B#Z0*00	1000	30	0.7	7	25	7	-70	10	18	2500	D	T3	283.50	0.205
TWAE108*030□BEZ0*00	1000	30	0.7	5	20	7	-70	10	18	2500	E	T4	283.50	0.148
TWAE158*030□BSZ0*00	1500	30	0.6	12	35	6	-72	10	20	3000	E	T4	425.25	0.222
50 Volts														
TWAB476*050□BSZ0*00	47	50	3	0.8	8	70	-28	13	15	1155	B	T2	37.39	0.057
TWAA686*050□BSZ0000	68	50	1.5	1	5	35	-25	8	15	1050	A	T1	54.09	0.262
TWAA686*050□BEZ0*00*	68	50	2.5	2	10	45	-25	20	25	1050	A	T1	54.09	0.262
TWAA107M050□BSZ0*00	100	50	5	2	15	70	-45	50	95	1500	A	T1	79.55	0.385
TWAB127*050□BEZ0*00	120	50	2	2	10	40	-45	8	15	1200	B	T2	95.46	0.147
TWAB157*050□BEZ0*00	150	50	2	2	10	25	-50	8	15	1400	B	T2	119.33	0.183
TWAB227*050□BSZ0*00	220	50	0.9	2	10	17.5	-50	8	15	1800	B	T2	175.01	0.269
TWAB227*050□BEZ0*00*	220	50	0.9	4	20	17.5	-50	18	28	1800	B	T2	175.01	0.269
TWAE337*050□B#Z0*00	330	50	0.8	2.5	25	15	-50	8	15	1900	E	T4	262.52	0.137
TWAD477*050□BSZ0*00	470	50	0.75	3	25	10	-50	8	15	2100	D	T3	373.89	0.270
TWAD477*050□BEZ0*00*	470	50	1	3	25	11	-50	8	15	2100	D	T3	373.89	0.270
TWAE477*050□B#Z0*00	470	50	0.75	3	30	10	-50	8	15	2200	E	T4	373.89	0.195
TWAE687*050□B#Z0*00	680	50	0.7	5	40	8	-58	10	20	2750	E	T4	540.94	0.282
TWAE757*050□BEZ0*00	750	50	0.6	12	60	8	-50	15	20	2800	E	T4	596.63	0.311
TWAD108*050□BEZ0*00	1000	50	1.5	20	125	12	-90	100	140	2500	D	T3	795.50	0.575
TWAE108*050□BSZ0*00	1000	50	1.0	12	90	20	-90	30	50	3200	E	T4	795.50	0.415
TWAE108*050□BEZ0*00*	1000	50	0.7	11	110	20	-70	30	40	3200	E	T4	795.50	0.415
TWAE128*050□BSZ0*00	1200	50	1.0	12	90	20	-90	30	50	3200	E	T4	954.60	0.498
TWAE158*050□BSZ0*00	1500	50	1	35	130	6	-75	45	55	3500	E	T4	1193.25	0.622
TWAE308M050□B#Z0*00	3000	50	0.3	30	150	3.5	-80	60	85	3100	E	T4	2386.50	1.244
TWAE308K050□BSZ0*00	3000	50	0.6	30	150	5	-90	90	100	3100	E	T4	2386.50	1.244
60 Volts														
TWAA476*060□BSZ0000	47	60	2	1	5	44	-25	8	12	1050	A	T1	53.93	0.261
TWAA476*060□BEZ0*00*	47	60	2	2	10	55	-25	15	25	1050	A	T1	53.93	0.261
TWAB107*060□BSZ0*00	100	60	1.5	1.7	10	30	-35	12	20	1650	B	T2	114.75	0.176
TWAB107*060□BEZ0*00*	100	60	2.5	1.7	10	40	-40	8	15	1100	B	T2	114.75	0.176
TWAB157*060□BSZ0000	150	60	1.1	2	10	20	-40	8	15	1650	B	T2	172.13	0.264
TWAB157*060□BEZ0*00*	150	60	1.5	2	10	30	-35	12	20	1650	B	T2	172.13	0.264
TWAD397*060□B#Z0*00	390	60	0.9	3	25	15	-60	8	15	2100	D	T3	447.53	0.323
TWAE567*060□B#Z0*00	560	60	0.8	5	40	10	-58	8	15	2750	E	T4	642.60	0.335
TWAE687*060□BEZ0*00	680	60	0.6	13	65	8	-50	15	20	2800	E	T4	780.30	0.407
TWAE757*060□BEZ0*00	750	60	0.6	15	75	8	-50	15	20	2800	E	T4	860.63	0.449
TWAE108*060□BSZ0*00	1000	60	1	12	90	20	-90	30	50	3200	E	T4	1147.50	0.598

TWA SERIES

COTS-Plus Wet Electrolytic Tantalum Capacitor of Contents



RATINGS & PART NUMBER REFERENCE

ENERGY

Part Number	Cap (µF) 25°C at 120Hz	DC Rated Voltage (V) at 85°C	ESR max (ohms) at 120Hz	DC Leakage max (µA)		Impedance max (Ohms) -55°C at 120Hz	Maximum Capacitance Change (%)			AC Ripple (mA rms) 85°C at 40kHz	Case Size		Energy (mJ)	Energy / volume (mJ/mm ³)
				+25°C	+85°C & +125°C		-55°C	+85°C	+125°C		KAVX	DLA		
TWAE108*060□BEZ0*00*	1000	60	0.5	20	60	4.5	-70	30	60	3200	E	T4	1147.50	0.598
TWAE228M060□BEZ0*00	2200	60	0.5	40	120	3.0	-80	60	80	3000	E	T4	2524.50	1.316
75 Volt														
TWAA336*075□BSZ0000	33	75	2.5	1	5	66	-25	5	9	1050	A	T1	59.25	0.287
TWAA336*075□BEZ0*00*	33	75	2.5	2	10	70	-25	15	25	1050	A	T1	59.25	0.287
TWAA686M075□BSZ0*00	68	75	5	2	15	70	-45	50	95	1500	A	T1	122.09	0.591
TWAB107*075□BEZ0*00	100	75	2.5	2	10	40	-35	6	10	1400	B	T2	179.55	0.276
TWAB117*075□BSZ0000	110	75	1.3	2	10	24	-35	6	10	1650	B	T2	197.51	0.303
TWAB117*075□BEZ0*00*	110	75	1.5	2	10	30	-35	12	20	1650	B	T2	197.51	0.303
TWAE227*075□B#Z0*00	220	75	1.1	2.5	30	20	-50	6	10	1800	E	T4	395.01	0.206
TWAD337*075□BSZ0*00	330	75	1	3	30	12	-45	6	10	2100	D	T3	592.52	0.428
TWAD337*075□BEZ0*00*	330	75	1.2	3	30	15	-60	10	20	2100	D	T3	592.52	0.428
TWAE337*075□BEZ0*00	330	75	1	3	40	12	-50	6	10	2200	E	T4	592.52	0.309
TWAE477*075□B#Z0*00	470	75	0.9	5	50	12	-55	6	10	2750	E	T4	843.89	0.440
TWAE667*075□BSZ0*00	660	75	0.7	12	120	10	-70	30	40	2750	E	T4	1185.03	0.418
TWAE687*075□BEZ0*00*	680	75	0.9	11	110	10	-70	30	40	2750	E	T4	1220.94	0.636
TWAE757*075□B#Z0*00	750	75	0.7	12	120	10	-70	30	40	3800	E	T4	1346.63	0.702
TWAE108*075□BEZ0*00	1000	75	0.5	30	90	4.5	-70	30	60	3500	E	T4	1795.50	0.936
100 Volt														
TWAA106M100□BSZ0*00	10	100	3.5	5	25	190	-18	10	30	1050	A	T1	31.96	0.155
TWAA156*100□BSZ0000	15	100	3.5	1	5	125	-18	3	10	1050	A	T1	47.93	0.232
TWAA156*100□BEZ0*00*	15	100	5.5	7	35	140	-18	10	30	1050	A	T1	47.93	0.232
TWAB226*100□BSZ0*00	22	100	4	1	5	100	-10	8	15	1065	B	T2	70.30	0.108
TWAB686*100□BSZ0000	68	100	2.1	2	10	37	-30	4	12	1650	B	T2	217.29	0.334
TWAB686*100□BEZ0*00*	68	100	2.5	2	10	37	-30	4	12	1650	B	T2	217.29	0.334
TWAD157*100□B#Z0*00	150	100	1.6	3	25	22	-35	6	12	2100	D	T3	479.33	0.346
TWAD227*100□BEZ0*00	220	100	1.4	5	25	18	-50	10	15	2500	D	T3	703.01	0.508
TWAE227*100□B#Z0*00	220	100	1.2	5	50	15	-40	6	12	2750	E	T4	703.01	0.366
TWAE337*100□B#Z0*00	330	100	0.8	6	60	10	-45	7	20	3600	E	T4	1054.52	0.550
TWAE407*100□B#Z0*00	400	100	0.8	10	150	10	-50	10	35	4100	E	T4	1278.20	0.666
TWAE477*100□BSZ0*00	470	100	0.7	15	150	10	-50	10	35	4100	E	T4	1501.89	0.783
TWAE567*100□BSZ0*00	560	100	1.0	25	200	10	-60	45	110	4100	E	T4	1789.48	0.933
TWAE757*100□BEZ0*00	750	100	0.6	30	150	5	-60	50	120	4200	E	T4	2396.63	1.249
125 Volt														
TWAA106*125□BSZ0000	10	125	5.5	1	5	175	-15	3	10	1050	A	T1	49.96	0.242
TWAA106M125□BEZ0*00*	10	125	5.5	1	5	190	-15	10	30	1050	A	T1	49.96	0.242
TWAB276*125□BSZ0*00	27	125	4	2	10	100	-10	8	15	1200	B	T2	134.88	0.207
TWAB476*125□B#Z0*00	47	125	2.3	2	10	47	-25	5	12	1650	B	T2	234.79	0.360
TWAE826*125□BSZ0*00	82	125	1.6	2	10	39	-24	10	20	1900	E	T4	409.63	0.213
TWAD107*125□B#Z0*00	100	125	1.8	3	25	35	-35	5	12	2100	D	T3	499.55	0.361
TWAD127*125□BEZ0*00	120	125	1.8	3	25	35	-35	5	12	2100	D	T3	599.46	0.433
TWAE157*125□B#Z0*00	150	125	1.6	5	50	20	-35	6	12	2750	E	T4	749.33	0.391
TWAE227*125□BEZ0*00	220	125	1.4	10	50	12	-40	8	15	3600	E	T4	1099.01	0.573
TWAE337*125□B#Z0*00	330	125	1	15	150	20	-60	20	60	2500	E	T4	1648.52	0.859
TWAE477*125□BSZ0*00	470	125	1	30	160	25	-70	30	70	3500	E	T4	2347.89	1.224
TWAE567*125□BSZ0*00	560	125	1	30	160	25	-70	40	120	4200	E	T4	2797.48	1.458

Energy is calculated by this formula (consider derating factor):

$$\text{Energy} = \frac{1}{2} C \times ((V_r \times X)^2 - V_x^2)$$

where C = Capacitance

V_r = Rated Voltage

X = Recommended derating factor

V_x = 3V (invariable)

All technical data relates to an ambient temperature of +25°C. Capacitance and DF are measured at 120Hz, 0.5RMS with DC bias of 2.2V. DCL is measured at rated voltage after 5 minutes.

NOTE: KYOCERA AVX reserves the rights to supply higher voltage rating in the same case size, to the same reliability standards.

*Not recommended for new designs, for new design use part number with Inspection level "S" – COTS-Plus

$$\text{DF} = 2\pi f C \times (\text{ESR})$$

$$2\pi = 6.28$$

$$f = 120\text{Hz}$$

C = Actual measured capacitance

ESR = Actual measured ESR

TWA-Y SERIES

High Temperature – COTS-Plus 200°C Wet Electrolytic Tantalum Capacitor



GENERAL DESCRIPTION

The TWA-Y series represents a high temperature version of conventional wet electrolytic tantalum capacitors that are designed for use at 200°C. High capacitance cathode system allows high level of CV (Capacitance/Voltage) in standard case sizes.

Selected values of the TWA-Y are capable of up to 2000 hours of operation at extreme temperatures with the applicable derated voltage.

Mechanical testing being conducted in accordance to MIL-STD- 202, High Frequency vibration - method 204, test condition "D" Mechanical Shock Test - method 213, test condition "1".

This design includes a welded tantalum can and header assembly that provides a hermetic seal to withstand also harsh shock and vibration requirements.

Contact the factory for additional options for customized component design.

OUTLINE DIMENSIONS

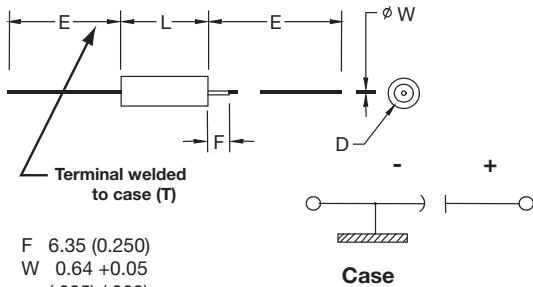

F 6.35 (0.250)
W 0.64 +0.05
(.025) (.002)
T 2.380 (.094)

CASE DIMENSIONS: millimeters (inches)

DLA Case Size	Case Size	L +0.79 (0.031) -0.41 (0.016)	D Without Insulating Sleeve ±0.41 (0.016)	D With Insulating Sleeve Max	E ±6.35 (0.250)
T1	A	11.51 (0.453)	4.78 (0.188)	5.56 (0.219)	38.10 (1.500)
T2	B	16.28 (0.641)	7.14 (0.281)	7.92 (0.312)	57.15 (2.250)
T3	D	19.46 (0.766)	9.52 (0.375)	10.31 (0.406)	57.15 (2.250)
T4	E	26.97 (1.062)	9.52 (0.375)	10.31 (0.406)	57.15 (2.250)

VOLTAGE RATINGS (Operating Temperature -55°C to 200°C)

Voltage (DC)									
Rated Voltage: (V _R)	85°C	15	25	30	50	60	75	100	125
Derated Voltage: (V _D)	125°C	10	15	20	30	40	50	65	85
High Temperature Voltage: (V _T)	200°C	9	12	18	30	36	45	60	75

HOW TO ORDER

PART NUMBER:

TWA	E	757	*	075	□	B	Y	Z	0	^	00
Type	Case Size	Capacitance Code	Capacitance Tolerance	Voltage Code	Insulation Sleeve	Packaging	Qualification	Reliability	Qualification Level	Termination Finish	Custom Test Options
		pF code: 1st two digits represent significant figures 3rd digit represents multiplier (number of zeros to follow)	K = ±10% M = ±20%		C = Without Sleeve S = With Sleeve	B = Tray Pack	Y = High Temp	Z = Non-ER	0 = N/A	0 = Sn/Pb 60/40 7 = Matte tin	00 = Standard

LEAD-FREE
LEAD-FREE COMPATIBLE COMPONENT

For RoHS compliant products,
please select correct termination style.

TWA-Y SERIES

High Temperature – COTS-Plus 200°C Wet Electrolytic Tantalum Capacitor



RIPPLE CURRENT MULTIPLIERS vs. Frequency, temperature and applied voltage^{1/2/}

Frequency of Applied Ripple Current		120Hz				800Hz				1kHz			
Ambient Still Air Temperature (°C)		≤55	85	105	125	≤55	85	105	125	≤55	85	105	125
% of 85°C Rated Peak Voltage	100%	0.60	0.39	-	-	0.71	0.43	-	-	0.72	0.45	-	-
	90%	0.60	0.46	-	-	0.71	0.55	-	-	0.72	0.55	-	-
	80%	0.60	0.52	0.35	-	0.71	0.62	0.42	-	0.72	0.62	0.42	-
	70%	0.60	0.58	0.44	-	0.71	0.69	0.52	-	0.72	0.70	0.52	-
	66-2/3%	0.60	0.60	0.46	0.27	0.71	0.71	0.55	0.32	0.72	0.72	0.55	0.32

Frequency of Applied Ripple Current		10kHz				40kHz				100kHz			
Ambient Still Air Temperature (°C)		≤55	85	105	125	≤55	85	105	125	≤55	85	105	125
% of 85°C Rated Peak Voltage	100%	0.88	0.55	-	-	1.00	0.63	-	-	1.10	0.69	-	-
	90%	0.88	0.67	-	-	1.00	0.77	-	-	1.10	0.85	-	-
	80%	0.88	0.76	0.52	-	1.00	0.87	0.59	-	1.10	0.96	0.65	-
	70%	0.88	0.85	0.64	-	1.00	0.97	0.73	-	1.10	1.07	0.80	-
	66-2/3%	0.88	0.88	0.68	0.40	1.00	1.00	0.77	0.45	1.10	1.10	0.85	0.50

1/At 125°C the rated voltage of the capacitors decreases to 66 2/3 of the 85°C rated voltage.

2/The peak of the applied ac ripple voltage plus the applied dc voltage must not exceed the dc voltage rating of the capacitors.

CAPACITANCE AND RATED VOLTAGE, V_R (VOLTAGE CODE) RANGE (LETTER DENOTES CASE SIZE)

Capacitance		Rated Voltage DC (V ^R) to 85°C								
μF	Code	15V	25V	30V	50V	60V	75V	100V	125V	
10	106				A			A ^(M)	A ^(M)	
15	156			A				A		
22	226		A			A	A	B		
27	276					A			B	
33	336	A			A		A			
47	476				B	A			B	
50	506					B				
56	566		A	A			B			
60	606				B					
68	686		A		A	B	A ^(M)	B		
82	826				B		B		D,E	
100	107		B	A,B	A ^(M)	B			D	
110	117						B			
120	127		A,B		B					
150	157			B		B		D	E	
180	187						D			
220	227			B	B	D	E	E	E	
270	277		B		D	E				
300	307			D						
330	337				E			E	E	
390	397	D		D						
400	407							E		
470	477			B,D			E	E	E	
560	567		B,E	E				E		
680	687						E			
750	757						E	E		
1000	108			D	E	E	E			
1200	128		D							
1500	158				E					
1800	188		E							
2200	228		E							
3000	308		E ^(M)							
4700	478		E							

Available Ratings (M tolerance only)

TWA-Y SERIES

High Temperature – COTS-Plus 200°C Wet Electrolytic Tantalum Capacitor



RATINGS & PART NUMBER REFERENCE

ENERGY

Part Number	Cap (µF) at 120Hz	DC Rated Voltage (V) at 85°C	ESR Max (Ohms) at 120Hz	DC Leakage max (µA)		Impedance max (Ohms) -55°C at 120Hz	Maximum Capacitance Change (%)			AC Ripple (mA rms) 85°C at 40kHz	Case Size		Lifetime at 200°C (hrs.)	Energy (mJ)	Energy / volume (mJ/mm³)
				+25°C	+85 &		-55°C	+85°C	+125°C		KAVX	DLA			
				15 VDC @ 85°C 10 VDC @ 125°C 9 VDC @ 200°C											
TWAA336*015□BYZ0*00	33	15	4	1	2	90	-28	14	16	820	A	T1	2000	2.86	0.014
TWAD397*015□BYZ0*00	390	15	1.7	7	28	48	-70	25	25	1396	D	T3	1000	33.78	0.024
25 VDC @ 85°C 15 VDC @ 125°C 12 VDC @ 200°C															
TWAA226*025□BYZ0*00	22	25	4	1	2	140	-20	10.5	12	825	A	T1	2000	23.46	0.114
TWAA566*025□BYZ0*00	56	25	4	1	2	140	-20	10.5	12	825	A	T1	500	4.30	0.021
TWAA686*025□BYZ0*00	68	25	4	1	2	140	-20	10.5	12	825	A	T1	500	10.95	0.053
TWAB107*025□BYZ0*00	100	25	2.5	1	10	60	-35	13	15	-	B	T2	2000	13.29	0.064
TWAA127*025□BYZ0*00	120	25	2.3	2	10	35	-42	20	25	1250	A	T1	500	19.55	0.030
TWAB127*025□BYZ0*00	120	25	2.3	2	10	60	-32	13	15	-	B	T2	500	23.46	0.036
TWAB277*025□BYZ0*00	270	25	0.9	4	20	17.5	-50	18	28	1800	B	T2	1000	52.79	0.081
TWAB567*025□BYZ0*00	560	25	1.0	2	10	12	-65	10	15	2100	B	T2	1000	109.48	0.168
TWAE567*025□BYZ0*00	560	25	1.3	9	36	25	-65	25	30	-	E	T4	2000	109.48	0.057
TWAD128*025□BYZ0*00	1200	25	0.65	5	20	7	-70	12	18	2600	D	T3	1000	234.60	0.169
TWAE188*025□BYZ0*00	1800	25	0.5	6	25	7	-75	12	20	3100	E	T4	2000	351.90	0.183
TWAE228*025□BYZ0*00	2200	25	0.5	10	80	10	-90	30	50	3200	E	T4	2000	430.10	0.224
TWAE308M025□BYZ0*00	3000	25	0.5	15	30	3.5	-80	60	85	3100	E	T4	500	586.50	0.306
TWAE478*025□BYZ0*00	4700	25	0.5	30	180	5	-90	60	80	4250	E	T4	500	918.85	0.479
30 VDC @ 85°C 20 VDC @ 125°C 18 VDC @ 200°C															
TWAA156*030□BYZ0*00	15	30	4.4	1	2	200	-20	10.5	16	-	A	T1	2000	4.25	0.021
TWAA566*030□BYZ0*00	56	30	5.2	2	9	200	-48	12	15	-	A	T1	2000	15.88	0.077
TWAA107*030□BYZ0*00	100	30	2.3	2	10	35	-38	20	25	1200	A	T1	500	28.35	0.137
TWAB107*030□BYZ0*00	100	30	2.3	2	12	60	-30	10.5	12	-	B	T2	500	28.35	0.044
TWAB157*030□BYZ0*00	150	30	2.5	2	18	40	-48	13	15	1100	B	T2	2000	42.53	0.065
TWAB227*030□BYZ0*00	220	30	0.9	4	20	17.5	-50	18	28	1800	B	T2	1000	62.37	0.096
TWAD307*030□BYZ0*00	300	30	1.8	8	32	25	-51	20	25	-	D	T3	2000	85.05	0.061
TWAD397*030□BYZ0*00	390	30	1.8	6	18	25	-65	18	25	-	D	T3	2000	110.57	0.080
TWAB477*030□BYZ0*00	470	30	1.0	2	10	15	-65	10	18	1800	B	T2	1000	133.25	0.205
TWAD477*030□BYZ0*00	470	30	1.0	3	25	15	-65	15	25	1600	D	T3	2000	133.25	0.096
TWAE567*030□BYZ0*00	560	30	1.3	9	36	25	-65	25	30	-	E	T4	2000	158.76	0.083
TWAD108*030□BYZ0*00	1000	30	0.7	7	25	7	-70	10	18	2500	D	T3	1000	283.50	0.205
50 VDC @ 85°C 30 VDC @ 125°C 30 VDC @ 200°C															
TWAA106*050□BYZ0*00	10	50	5.3	1	2	250	-24	8	9	715	A	T1	2000	7.96	0.039
TWAA336*050□BYZ0*00	33	50	5	2	9	200	-39	10	12	-	A	T1	2000	26.25	0.127
TWAB476*050□BYZ0*00	47	50	3	0.8	8	70	-28	13	15	1155	B	T2	500	37.39	0.057
TWAB606*050□BYZ0*00	60	50	2.6	2	12	60	-30	10.5	12	-	B	T2	500	47.73	0.073
TWAA686*050□BYZ0*00	68	50	2.5	2	10	45	-25	20	25	1050	A	T1	1000	54.09	0.262
TWAB826*050□BYZ0*00	82	50	2.4	2	16	60	-32	13	15	-	B	T2	500	65.23	0.100
TWAA107M050□BYZ0*00	100	50	5	2	15	70	-45	50	95	1500	A	T1	500	79.55	0.385
TWAB127*050□BYZ0*00	120	50	2.5	4	24	40	-42	12	15	-	B	T2	2000	95.46	0.147
TWAB227*050□BYZ0*00	220	50	0.9	4	20	17.5	-50	18	28	1800	B	T2	1000	175.01	0.269
TWAD277*050□BYZ0*00	270	50	1.8	8	32	25	-51	20	25	-	D	T3	2000	214.79	0.155
TWAE337*050□BYZ0*00	330	50	1.5	9	36	25	-46	25	30	1900	E	T4	2000	262.52	0.137
TWAE108*050□BYZ0*00	1000	50	0.7	11	110	20	-70	30	40	3200	E	T4	2000	795.50	0.415
TWAE158*050□BYZ0*00	1500	50	1	35	130	6	-75	45	55	3500	E	T4	1000	1193.25	0.622
60 VDC @ 85°C 40 VDC @ 125°C 36 VDC @ 200°C															
TWAA226*060□BYZ0*00	22	60	5	3	12	200	-34	10	12	500	A	T1	2000	25.25	0.122
TWAA276*060□BYZ0*00	27	60	5	3	12	200	-34	10	12	-	A	T1	2000	30.98	0.150
TWAA476*060□BYZ0*00	47	60	2	2	10	55	-25	15	25	1050	A	T1	500	53.93	0.261
TWAB506*060□BYZ0*00	50	60	2.6	2	12	60	-30	10.5	12	-	B	T2	500	57.38	0.088
TWAB686*060□BYZ0*00	68	60	2.5	2	16	60	-32	10.5	12	-	B	T2	500	78.03	0.120
TWAB107*060□BYZ0*00	100	60	2.5	1.7	10	40	-40	8	15	1100	B	T2	2000	114.75	0.176
TWAB157*060□BYZ0*00	150	60	1.5	2	10	30	-35	12	20	1650	B	T2	500	172.13	0.264
TWAD227*060□BYZ0*00	220	60	1.8	8	32	25	-45	16	20	-	D	T3	2000	252.45	0.182
TWAE277*060□BYZ0*00	270	60	1.3	9	36	25	-45	20	25	-	E	T4	2000	309.83	0.161
TWAE108*060□BYZ0*00	1000	60	0.5	20	60	4.5	-70	30	60	3200	E	T4	2000	1147.50	0.598
75 VDC @ 85°C 50 VDC @ 125°C 45 VDC @ 200°C															
TWAA226*075□BYZ0*00	22	75	5.1	3	12	157	-19	10	12	600	A	T1	2000	39.50	0.191
TWAA336*075□BYZ0*00	33	75	2.5	2	10	70	-25	15	25	1050	A	T1	1000	59.25	0.287
TWAB566*075□BYZ0*00	56	75	2.6	2	17	60	-30	10.5	15	-	B	T2	500	100.55	0.154
TWAA686M075□BYZ0*00	68	75	5	2	15	70	-45	50	95	1500	A	T1	500	122.09	0.591
TWAB826*075□BYZ0*00	82	75	2.5	4	24	37	-30	12	15	-	B	T2	500	147.23	0.226
TWAB117*075□BYZ0*00	110	75	1.5	2	10	30	-35	12	20	1650	B	T2	500	197.51	0.303
TWAD187*075□BYZ0*00	180	75	2.2	9	36	25	-40	16	20	-	D	T3	2000	323.19	0.233
TWAE227*075□BYZ0*00	220	75	1.2	5	50	20	-40	8	15	1800	E	T4	2000	395.01	0.206
TWAE477*075□BYZ0*00	470	75	0.9	10	125	10	-50	10	35	2750	E	T4	1000	843.89	0.440
TWAE687*075□BYZ0*00	680	75	0.9	11	110	10	-70	30	40	2750	E	T4	500	1220.94	0.636
TWAE757*075□BYZ0*00	750	75	0.7	12	120	10	-70	30	40	3800	E	T4	500	1346.63	0.702
TWAE108*075□BYZ0*00	1000	75	0.5	30	90	4.5	-70	30	60	3500	E	T4	1000	1795.50	0.936
100 VDC @ 85°C 65 VDC @ 125°C 60 VDC @ 200°C															
TWAA106M100□BYZ0*00	10	100	3.5	5	25	190	-18	10	30	1050	A	T1	2000	31.96	0.155

TWA-Y SERIES

High Temperature – COTS-Plus 200°C Wet Electrolytic Tantalum Capacitor



RATINGS & PART NUMBER REFERENCE

ENERGY

Part Number	Cap (µF) 25°C at 120Hz	DC Rated Voltage (V) at 85°C	ESR Max (Ohms) at 120Hz	DC Leakage max (µA)		Impedance max (Ohms) -55°C at 120Hz	Maximum Capacitance Change (%)			AC Ripple (mA rms) 85°C at 40kHz	Case Size		Lifetime at 200°C (hrs.)	Energy (mJ)	Energy / volume (mJ/mm³)
				+25°C	+85 &		-55°C	+85°C	+125°C		KAVX	DLA			
TWAA156*100□BYZ0*00	15	100	5.5	7	35	140	-18	10	30	1050	A	T1	500	47.93	0.232
TWAB226*100□BYZ0*00	22	100	4	1	5	100	-10	8	15	1065	B	T2	500	70.30	0.108
TWAB686*100□BYZ0*00	68	100	2.5	2	10	37	-30	4	12	1650	B	T2	500	217.29	0.334
TWAD157*100□BYZ0*00	150	100	1.6	3	25	22	-35	6	12	2100	D	T3	2000	479.33	0.346
TWAE227*100□BYZ0*00	220	100	1.2	5	50	15	-40	6	12	2750	E	T4	1000	703.01	0.366
TWAE337*100□BYZ0*00	330	100	0.8	6	60	10	-45	7	20	3600	E	T4	2000	1054.52	0.550
TWAE407*100□BYZ0*00	400	100	0.8	10	150	10	-50	10	35	4100	E	T4	2000	1278.20	0.666
TWAE477*100□BYZ0*00	470	100	0.7	15	150	10	-50	10	35	4100	E	T4	2000	1501.89	0.783
TWAE567*100□BYZ0*00	560	100	1.0	25	200	10	-60	45	110	4100	E	T4	1500	1789.48	0.933
TWAE757*100□BYZ0*00	750	100	0.6	30	150	5	-60	50	120	4200	E	T4	500	2396.63	1.249
125 VDC @ 85°C 85 VDC @ 125°C 75 VDC @ 200°C															
TWAA106M125□BYZ0*00	10	125	5.5	1	5	190	-15	10	30	1050	A	T1	2000	49.96	0.242
TWAB276*125□BYZ0*00	27	125	4	2	10	100	-10	8	15	1200	B	T2	500	134.88	0.207
TWAB476*125□BYZ0*00	47	125	2.3	2	10	47	-25	5	12	1650	B	T2	1000	234.79	0.360
TWAD826*125□BYZ0*00	82	125	2.8	12	48	50	-30	15	17	-	D	T3	2000	409.63	0.296
TWAE826*125□BYZ0*00	82	125	1.6	2	10	39	-24	10	20	1900	E	T4	2000	409.63	0.213
TWAD107*125□BYZ0*00	100	125	1.8	3	25	35	-35	5	12	2100	D	T3	2000	499.55	0.361
TWAE157*125□BYZ0*00	150	125	1.6	5	50	20	-35	6	16	2750	E	T4	2000	749.33	0.391
TWAE227*125□BYZ0*00	220	125	1.4	10	50	12	-40	8	15	3600	E	T4	2000	1099.01	0.573
TWAE337*125□BYZ0*00	330	125	1	15	150	20	-60	20	60	2500	E	T4	2000	1648.52	0.859
TWAE477*125□BYZ0*00	470	125	1	30	160	25	-70	30	70	3500	E	T4	1000	2347.89	1.224

Energy is calculated by this formula (consider derating factor):

$$\text{Energy} = \frac{1}{2} C \times ((V_r \times X)^2 - V_x^2)$$

where C = Capacitance

V_r = Rated Voltage

X = Recommended derating factor

V_x = 3V (invariable)

All technical data relates to an ambient temperature of +25°C. Capacitance and DF are measured at 120Hz, 0.5RMS with DC bias of 2.2V. DCL is measured at rated voltage after 5 minutes. NOTE: KYOCERA AVX reserves the rights to supply higher voltage rating in the same case size, to the same reliability standards.

$$DF = 2\pi f C \times (ESR)$$

$$2\pi = 6.28$$

$$f = 120\text{Hz}$$

C = Actual measured capacitance

ESR = Actual measured ESR

RECOMMENDED DERATED FACTOR

Voltage and temperature derating as percentage of V_r

TWA-Y 200°C Voltage vs Temperature Rating

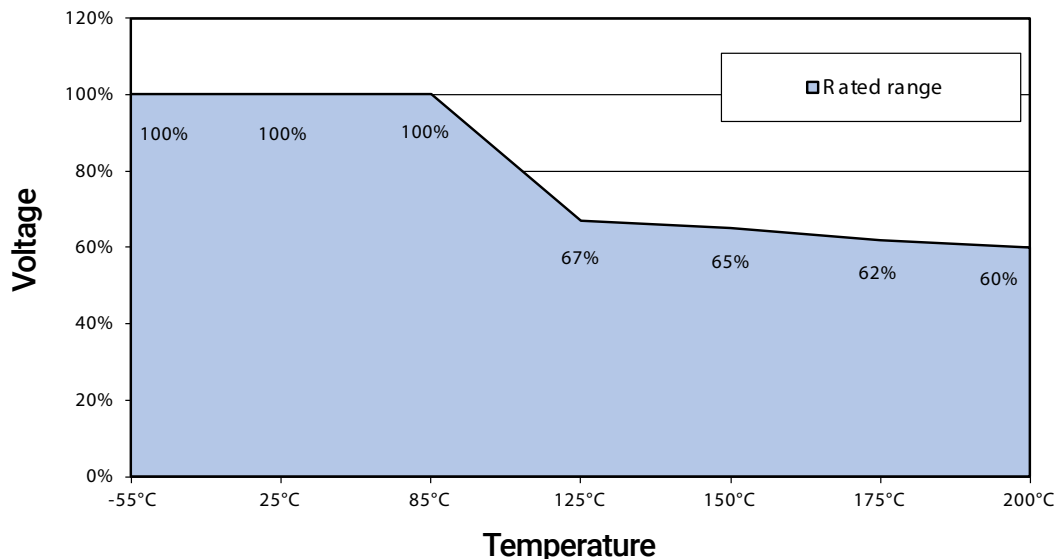

TWA-X SERIES



High Temperature – COTS-Plus 230°C Wet Electrolytic Tantalum Capacitor



The TWA-X series represents a high temperature version of conventional wet electrolytic tantalum capacitors that are designed for use at 230°C. High capacitance cathode system allows high level of CV (Capacitance/Voltage) in standard case sizes.

Selected values of the TWA-X are capable of up to 500 hours of operation at extreme temperatures with the applicable derated voltage.

Mechanical testing being conducted in accordance to MIL-STD- 202, High Frequency vibration - method 204, test condition "D" Mechanical Shock Test - method 213, test condition "I".

This design includes a welded tantalum can and header assembly that provides a hermetic seal to withstand also harsh shock and vibration requirements.

Contact the factory for additional options for customized component design.

OUTLINE DIMENSIONS

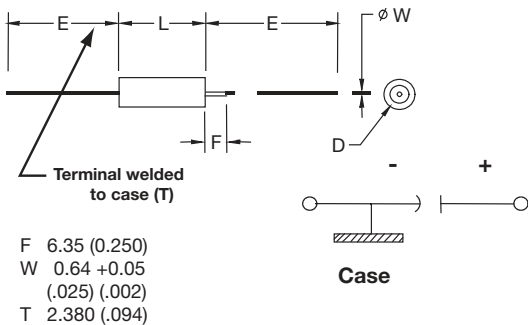

CASE DIMENSIONS: millimeters (inches)

DLA Case Size	Case Size	L +0.79 (0.031) -0.41 (0.016)	D Without Insulating Sleeve ±0.41 (0.016)	D With Insulating Sleeve Max	E ±6.35 (0.250)
T4	E	26.97 (1.062)	9.52 (0.375)	10.31 (0.406)	57.15 (2.250)

HOW TO ORDER

PART NUMBER:

TWA	E	407	*	100	□	B	X	Z	0	^	00
Type	Case Size	Capacitance Code pF code: 1st two digits represent significant figures 3rd digit represents multiplier (number of zeros to follow)	Capacitance Tolerance K = ±10% M = ±20%	Voltage Code	Insulation Sleeve C = Without Sleeve S = With Sleeve	Packaging B = Tray Pack	Qualification X = High-Temp up to 230°C	Reliability Z = Non-ER	Qualification Level 0 = N/A	Termination Finish 0 = Sn/Pb 60/40 7 = Matte tin	Custom Test Options 00 = Standard



For RoHS compliant products, please select correct termination style.



The Important Information/Disclaimer is incorporated in the catalog where these specifications came from or available online at www.kyocera-avx.com/disclaimer/ by reference and should be reviewed in full before placing any order.

TDS-HIRELTANT-0005 | Rev 1

RIPPLE CURRENT MULTIPLIERS vs. Frequency, temperature and applied voltage^{1/2/}

Frequency of Applied Ripple Current	120Hz				800Hz				1kHz				
	≤55	85	105	125	≤55	85	105	125	≤55	85	105	125	
% of 85°C Rated Peak Voltage	100%	0.60	0.39	–	–	0.71	0.43	–	–	0.72	0.45	–	–
	90%	0.60	0.46	–	–	0.71	0.55	–	–	0.72	0.55	–	–
	80%	0.60	0.52	0.35	–	0.71	0.62	0.42	–	0.72	0.62	0.42	–
	70%	0.60	0.58	0.44	–	0.71	0.69	0.52	–	0.72	0.70	0.52	–
66-2/3%	0.60	0.60	0.46	0.27	0.71	0.71	0.55	0.32	0.72	0.72	0.55	0.32	

Frequency of Applied Ripple Current	10kHz				40kHz				100kHz				
	≤55	85	105	125	≤55	85	105	125	≤55	85	105	125	
% of 85°C Rated Peak Voltage	100%	0.88	0.55	–	–	1.00	0.63	–	–	1.10	0.69	–	–
	90%	0.88	0.67	–	–	1.00	0.77	–	–	1.10	0.85	–	–
	80%	0.88	0.76	0.52	–	1.00	0.87	0.59	–	1.10	0.96	0.65	–
	70%	0.88	0.85	0.64	–	1.00	0.97	0.73	–	1.10	1.07	0.80	–
66-2/3%	0.88	0.88	0.68	0.40	1.00	1.00	0.77	0.45	1.10	1.10	0.85	0.50	

1/At 125°C the rated voltage of the capacitors decreases to 66 2/3 of the 85°C rated voltage.

2/The peak of the applied ac ripple voltage plus the applied dc voltage must not exceed the dc voltage rating of the capacitors.

CAPACITANCE AND RATED VOLTAGE, V_R (VOLTAGE CODE) RANGE (LETTER DENOTES CASE SIZE)

Capacitance		Rated Voltage DC (V _R) to 85°C		
μF	Code	75V	100V	125V
220	227	E		
330	337			E
400	407		E	
470	477			

Available Ratings

RATINGS & PART NUMBER REFERENCE

ENERGY

Part Number	Case Size		Cap (μF) 25°C at 120Hz	DC Rated Voltage (V) At 85°C	ESR max (Ohms) at 120Hz	DC Leakage max (μA)		Impedance max (Ohms) -55°C at 120Hz	Maximum Capacitance Change (%)			AC Ripple (mA rms) 85°C at 40kHz	85°C Capability max. Time at 85°C (hrs)	200°C Capability max.			230°C Capability max.			Energy (mJ)	Energy / volume (mJ/mm ³)
	Code	DLA				+25°C	+85 & +125°C		-55°C	+85°C	+125°C			Ur (V)	Time at 200°C (hrs)	DCL@ 200°C (μA)	Ur (V)	Time at 230°C (hrs)	DCL@ 230°C (μA)		
	TWAE227*075□BXZ0*00	E				T4	220		75	1.2	5			50	20	-40	8	15	1800		
TWAE407*100□BXZ0*00	E	T4	400	100	0.8	10	150	10	-50	10	35	4100	2000	60	2000	1000	25	500	1000	1278.20	0.666
TWAE337*125□BXZ0*00	E	T4	330	125	0.8	10	60	10	-45	15	25	3600	500	75	500	1000	40	500	1000	1648.52	0.859

Energy is calculated by this formula (consider derating factor):

$$\text{Energy} = \frac{1}{2} C \times ((V_r \times X)^2 - V_x^2)$$

where C = Capacitance

V_r = Rated Voltage

X = Recommended derating factor

V_x = 3V (invariable)

All technical data relates to an ambient temperature of +25°C. Capacitance and DF are measured at 120Hz, 0.5RMS with DC bias of 2.2V. DCL is measured at rated voltage after 5 minutes.

NOTE: KYOCERA AVX reserves the rights to supply higher voltage rating in the same case size, to the same reliability standards.

$$\text{DF} = 2\pi f C \times (\text{ESR})$$

$$2\pi = 6.28$$

$$f = 120\text{Hz}$$

C = Actual measured capacitance

ESR = Actual measured ESR

TWS ELECTROLYTIC TANTALUM CAPACITOR

DLA 13017

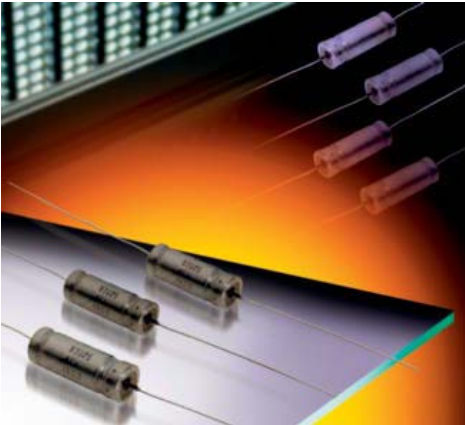

The TWS series, built to the requirements of DLA 13017, represents a family of axial leaded wet tantalum capacitors that encompasses the high capacitance values of DLA 93026 with additional mechanical stability for increased vibration capability.

Vibration Capabilities:

Vibration: MIL-PRF-39006, MIL-STD-202, Method 204, Test Condition E, 50 g

Random Vibration: MIL-PRF-39006, MIL-STD-202, Method 214, Test condition II- G, 27.78 g

Shock: MIL-PRF-39006, MIL-STD-202, Method 213, Condition D, 500 g

Components built to DLA 13017 also see enhanced thermal shock testing with an increase from the standard 30 cycles to 300 cycles.

In addition, this family includes reverse voltage testing in accordance with MIL-PRF- 39006, with a maximum dc potential of -3 V.

Customized capacitance and voltage packages are possible and welcomed. Contact the factory about design possibilities beyond those contained in this datasheet.

Operating Temperature -55°C to 125°C

OUTLINE DIMENSIONS

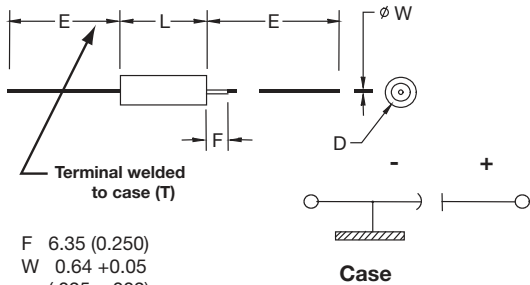

- F 6.35 (0.250)
- W 0.64 +0.05
(.025 +.002)
- T 2.380 (.094)

CASE DIMENSIONS: millimeters (inches)

DLA Case Size	Case Size	L +0.79 (0.031) -0.41 (0.016)	D		E ±6.35 (0.250)
			Without Insulating Sleeve ±0.41 (0.016)	With Insulating Sleeve Max	
T1	A	11.51 (0.453)	4.78 (0.188)	5.56 (0.219)	38.10 (1.500)
T2	B	16.28 (0.641)	7.14 (0.281)	7.92 (0.312)	57.15 (2.250)
T3	D	19.46 (0.766)	9.52 (0.375)	10.31 (0.406)	57.15 (2.250)
T4	E	26.97 (1.062)	9.52 (0.375)	10.31 (0.406)	57.15 (2.250)

TWS ELECTROLYTIC TANTALUM CAPACITOR

DLA 13017

HOW TO ORDER PART NUMBER:

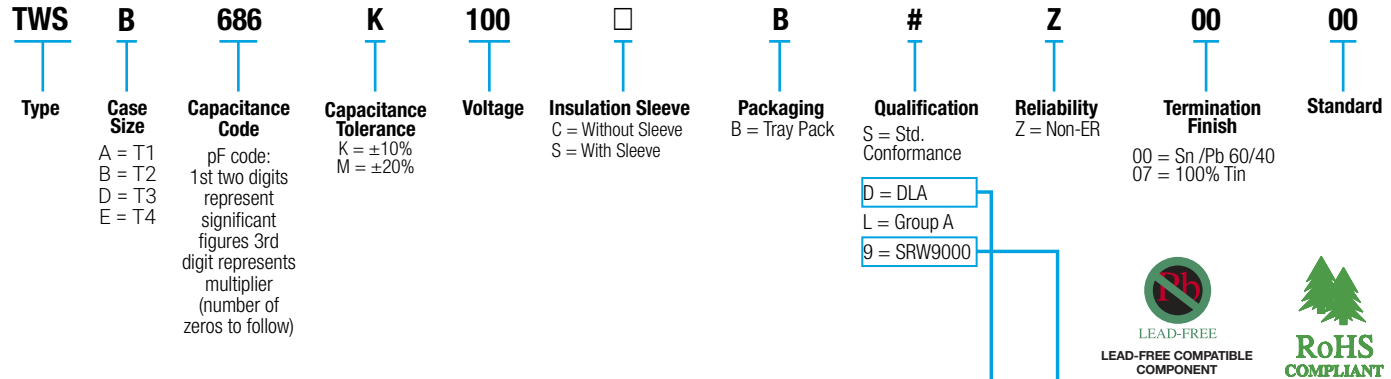

DLA PART IDENTIFICATION NUMBER (PIN):

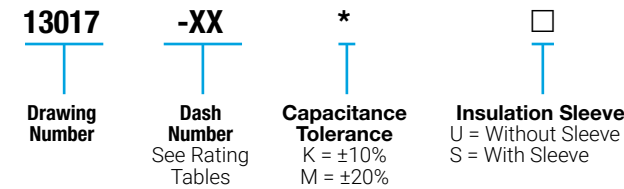

SPACE LEVEL OPTIONS TO SRW9000*:

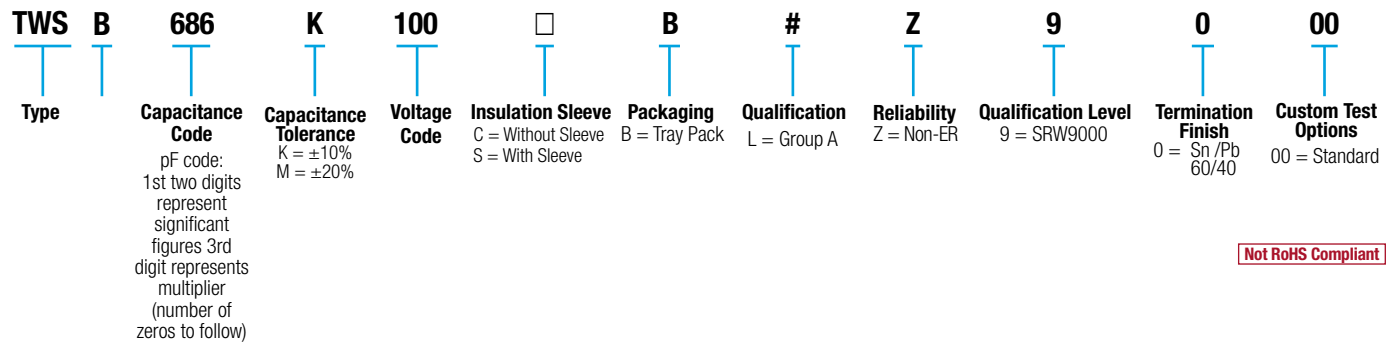

*Check with factory for availability and testing details.

RIPPLE CURRENT MULTIPLIERS vs. Frequency, temperature and applied voltage^{1/2/}

Frequency of Applied Ripple Current		120Hz				800Hz				1kHz			
		≤55	85	105	125	≤55	85	105	125	≤55	85	105	125
% of 85°C Rated Peak Voltage	100%	0.60	0.39	-	-	0.71	0.43	-	-	0.72	0.45	-	-
	90%	0.60	0.46	-	-	0.71	0.55	-	-	0.72	0.55	-	-
	80%	0.60	0.52	0.35	-	0.71	0.62	0.42	-	0.72	0.62	0.42	-
	70%	0.60	0.58	0.44	-	0.71	0.69	0.52	-	0.72	0.70	0.52	-
	66-2/3%	0.60	0.60	0.46	0.27	0.71	0.71	0.55	0.32	0.72	0.72	0.55	0.32

Frequency of Applied Ripple Current		10kHz				40kHz				100kHz			
		≤55	85	105	125	≤55	85	105	125	≤55	85	105	125
% of 85°C Rated Peak Voltage	100%	0.88	0.55	-	-	1.00	0.63	-	-	1.10	0.69	-	-
	90%	0.88	0.67	-	-	1.00	0.77	-	-	1.10	0.85	-	-
	80%	0.88	0.76	0.52	-	1.00	0.87	0.59	-	1.10	0.96	0.65	-
	70%	0.88	0.85	0.64	-	1.00	0.97	0.73	-	1.10	1.07	0.80	-
	66-2/3%	0.88	0.88	0.68	0.40	1.00	1.00	0.77	0.45	1.10	1.10	0.85	0.50

1/At 125°C the rated voltage of the capacitors decreases to 66 2/3 of the 85°C rated voltage.

2/The peak of the applied ac ripple voltage plus the applied dc voltage must not exceed the dc voltage rating of the capacitors.

TWS ELECTROLYTIC TANTALUM CAPACITOR

DLA 13017



RATINGS & PART NUMBER REFERENCE

Part Number	DLA Part Number	Cap (µF) 25°C at 120Hz	DC Rated Voltage (V) at 85°C	ESR max (ohms) at 120Hz	DC Leakage max (µA)		Impedance max (Ohms) -55°C at 120Hz	Maximum Capacitance Change (%)			AC Ripple (mA rms) 85°C at 40kHz	Case Size		
					+25°C	+85°C & +125°C		-55°C	+85°C	+125°C		AVX	DLA	
25 VDC at 85°C 15 VDC at 125°C														
TWSA127*025□B#Z0000	13017-01*□	120	25	1.3	1	5	25	-42	8	12	1250	A	T1	
TWSB567*025□B#Z0000	13017-02*□	560	25	0.83	2	10	12	-65	14	18	2000	B	T2	
TWSD128*025□B#Z0000	13017-03*□	1200	25	0.65	5	20	7	-70	15	20	2400	D	T3	
TWSE188*025□B#Z0000	13017-04*□	1800	25	0.5	6	25	7	-72	15	20	3000	E	T4	
30 VDC at 85°C 20 VDC at 125°C														
TWSA107*030□B#Z0000	13017-05*□	100	30	1.3	1	5	25	-38	8	12	1200	A	T1	
TWSB477*030□B#Z0000	13017-06*□	470	30	0.85	2	10	15	-65	14	18	1800	B	T2	
TWSD108*030□B#Z0000	13017-07*□	1000	30	0.7	7	25	7	-70	15	25	2200	D	T3	
TWSE158*030□B#Z0000	13017-08*□	1500	30	0.6	12	35	6	-72	15	25	2900	E	T4	
50 VDC at 85°C 30 VDC at 125°C														
TWSA686*050□B#Z0000	13017-09*□	68	50	1.5	1	5	35	-25	8	15	1050	A	T1	
TWSB227*050□B#Z0000	13017-10*□	220	50	0.9	2	10	17.5	-50	8	15	1800	B	T2	
TWSE687*050□B#Z0000	13017-12*□	680	50	0.7	5	40	8	-58	10	20	2700	E	T4	
60V VDC at 85°C 40 VDC at 125°C														
TWSB157*060□B#Z0000	13017-14*□	150	60	1.1	2	10	20	-40	8	15	1800	B	T2	
TWSD397*060□B#Z0000	13017-15*□	390	60	0.9	3	25	15	-45	8	15	2100	D	T3	
TWSE567*060□B#Z0000	13017-16*□	560	60	0.8	5	40	10	-58	8	15	2700	E	T4	
75V VDC at 85°C 50 VDC at 125°C														
TWSA336*075□B#Z0000	13017-17*□	33	75	2.5	1	5	66	-25	5	9	1050	A	T1	
TWSB117*075□B#Z0000	13017-18*□	110	75	1.3	2	10	24	-35	6	10	1650	B	T2	
TWSE477*075□B#Z0000	13017-20*□	470	75	0.9	5	50	12	-50	6	10	2700	E	T4	
100 VDC at 85°C 65 VDC at 125°C														
TWSA156*100□B#Z0000	13017-21*□	15	100	3.5	1	5	125	-18	3	10	1050	A	T1	
TWSB686*100□B#Z0000	13017-22*□	68	100	2.1	2	10	37	-30	4	12	1650	B	T2	
TWSD157*100□B#Z0000	13017-23*□	150	100	1.6	3	25	22	-35	6	12	2100	D	T3	
TWSE227*100□B#Z0000	13017-24*□	220	100	1.2	5	50	15	-40	6	12	2700	E	T4	
125 VDC at 85°C 85 VDC at 125°C														
TWSD826*125□B#Z0000	13017-27*□	82	125	1.8	3	25	40	-35	5	12	1950	D	T3	
TWSD107*125□B#Z0000	13017-28*□	100	125	1.8	3	25	35	-35	5	12	2100	D	T3	
TWSE157*125□B#Z0000	13017-29*□	150	125	1.6	5	50	20	-35	6	12	2750	E	T4	

All technical data relates to an ambient temperature of +25°C. Capacitance and DF are measured at 120Hz, 0.5RMS with DC bias of 2.2V.

DCL is measured at rated voltage after 5 minutes.

NOTE: KYOCERA AVX reserves the rights to supply higher voltage rating in the same case size, to the same reliability standards.

TWC SERIES

MIL-PRF-39006 Series – Military Conventional Wet Tantalum



This data sheet contains the MIL-PRF-39006 ratings for which KYOCERA AVX is a qualified approved supplier. This will be continually updated as the qualification expands. For COTS-Plus equivalent ratings please refer to the TWC data sheet located on the website.

This design is an axial leaded tubular case. It includes a welded tantalum can and header assembly that provides a hermetic seal to withstand harsh environments. The 1000 hour failure rates of 1% and 0.1% correspond to “M” and “P” respectively. For details on testing conditions please refer to MIL-PRF-39006.



Currently qualified M39006 ratings include T2-T4 case sizes:

	M Level Reliability Dashes	P Level Reliability Dashes
M39006/22	6V-100V	6V-100V
M39006/25	6V-100V	6V-100V
M39006/30	6V-100V	6V-100V
M39006/31	6V-100V	6V-100V

OUTLINE DIMENSIONS

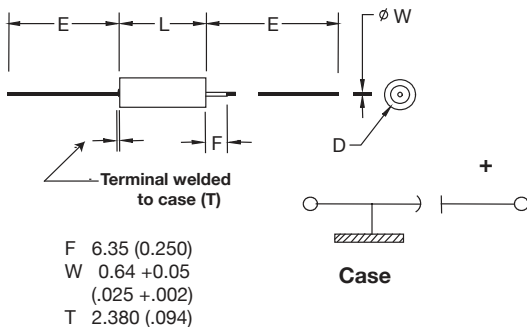

CASE DIMENSIONS: millimeters (inches)

DLA Case Size	Case Size	L +0.79 (0.031) -0.41 (0.016)	D Basic Case ±0.41 (0.016)	D Insulated Case Max	E ±6.35 (0.250)
T1	A	11.51 (0.453)	4.78 (0.188)	5.56 (0.219)	38.10 (1.500)
T2	B	16.28 (0.641)	7.14 (0.281)	7.92 (0.312)	57.15 (2.250)
T3	D	19.46 (0.766)	9.52 (0.375)	10.31 (0.406)	57.15 (2.250)
T4	E	26.97 (1.062)	9.52 (0.375)	10.31 (0.406)	57.15 (2.250)

VOLTAGE RATINGS (Operating Temperature -55°C to 125°C)

Voltage (DC)											
Rated Voltage: (V _r)	85°C	6	8	10	15	25	30	50	60	75	100
Derated Voltage: (V _d)	125°C	4	5	6	10	15	20	30	40	50	65
Surge Voltage: (V _s)	85°C	6.9	9.2	11.5	17.3	28.8	34.5	57.5	69	86.3	115

TWC SERIES

MIL-PRF-39006 Series – Military Conventional Wet Tantalum



HOW TO ORDER MILITARY M39006 PART NUMBER:

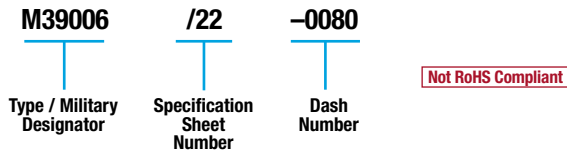

RIPPLE CURRENT MULTIPLIERS vs. Frequency, temperature and applied voltage^{1/2/3/}

Frequency of Applied Ripple Current		120Hz				800Hz				1kHz			
		≤55	85	105	125	≤55	85	105	125	≤55	85	105	125
% of 85°C Rated Peak Voltage	100%	0.60	0.39	–	–	0.71	0.43	–	–	0.72	0.45	–	–
	90%	0.60	0.46	–	–	0.71	0.55	–	–	0.72	0.55	–	–
	80%	0.60	0.52	0.35	–	0.71	0.62	0.42	–	0.72	0.62	0.42	–
	70%	0.60	0.58	0.44	–	0.71	0.69	0.52	–	0.72	0.70	0.52	–
	66-2/3%	0.60	0.60	0.46	0.27	0.71	0.71	0.55	0.32	0.72	0.72	0.55	0.32

Frequency of Applied Ripple Current		10kHz				40kHz				100kHz			
		≤55	85	105	125	≤55	85	105	125	≤55	85	105	125
% of 85°C Rated Peak Voltage	100%	0.88	0.55	–	–	1.00	0.63	–	–	1.10	0.69	–	–
	90%	0.88	0.67	–	–	1.00	0.77	–	–	1.10	0.85	–	–
	80%	0.88	0.76	0.52	–	1.00	0.87	0.59	–	1.10	0.96	0.65	–
	70%	0.88	0.85	0.64	–	1.00	0.97	0.73	–	1.10	1.07	0.80	–
	66-2/3%	0.88	0.88	0.68	0.40	1.00	1.00	0.77	0.45	1.10	1.10	0.85	0.50

1/ At 125°C the rated voltage of the capacitors decreases to 66 2/3 of the 85°C rated voltage.
 2/ The peak of the applied ac ripple voltage plus the applied dc voltage must not exceed the dc voltage rating of the capacitors.
 3/ The ripple current listed in the parametric tables represents a rating calculated by using a maximum internal temperature rise (ΔT) at 50°C at 40 kHz at 85°C ambient temperature, with a maximum peak rated voltage of 66.67 percent of the 85°C peak voltage rating.

TWC SERIES

MIL-PRF-39006 Series – Military Conventional Wet Tantalum



M39006 /22 RATINGS AND DASH NUMBER REFERENCE

M39006/22 Dashes		Tolerance ± (%)	Cap (µF) 25°C at 120Hz	DC Rated Voltage (V) at 85°C	DC Leakage (µA)		DF max (%)	ESR max (Ohms) at 120Hz	Impedance max (Ohms) -55°C at 120Hz	Maximum Capacitance Change (%)			AC Ripple (mA rms) 85°C at 40kHz	Case Size
M Level	P Level				+25°C	+85°C & +125°C				-55°C	+85°C	+125°C		
-0007	-0227	20	140	6	1	3	21	1.99	40	-40	14	16	1200	T2
-0008	-0228	10												
-0009	-0229	5												
-0010	-0230	20	270	6	1	6.5	45	2.21	25	-44	17.5	20	1375	T2
-0011	-0231	10												
-0012	-0232	5												
-0013	-0233	20	330	6	2	7.9	36	1.45	20	-44	14	16	1800	T3
-0014	-0234	10												
-0015	-0235	5												
-0016	-0236	20	560	6	2	13	55	1.3	25	-64	17.5	20	1900	T3
-0017	-0237	10												
-0018	-0238	5												
-0019	-0239	20	1200	6	3	14	90	1	20	-80	25	25	2265	T4
-0020	-0240	10												
-0021	-0241	5												
-0022	-0242	20	120	8	1	2	20	2.21	50	-44	17.5	20	1220	T2
-0023	-0243	10												
-0024	-0244	5												
-0025	-0245	20	220	8	1	7	37	2.23	30	-44	17.5	20	1370	T2
-0026	-0246	10												
-0027	-0247	5												
-0028	-0248	20	290	8	2	6	34	1.56	25	-64	17.5	20	1770	T3
-0029	-0249	10												
-0030	-0250	5												
-0031	-0251	20	430	8	2	14	46	1.42	25	-64	17.5	20	1825	T3
-0032	-0252	10												
-0033	-0253	5												
-0034	-0254	20	850	8	4	16	60	0.94	22	-80	25	25	2330	T4
-0035	-0255	10												
-0036	-0256	5												
-0037	-0257	20	100	10	1	4	15	1.99	60	-36	14	16	1200	T2
-0038	-0258	10												
-0039	-0259	5												
-0040	-0260	20	180	10	1	7	30	2.21	40	-36	14	16	1.365	T2
-0041	-0261	10												
-0042	-0262	5												
-0043	-0263	20	250	10	2	10	30	1.59	30	-40	14	16	1720	T3
-0044	-0264	10												
-0045	-0265	5												
-0046	-0266	20	390	10	2	16	44	1.5	25	-64	17.5	20	1800	T3
-0047	-0267	10												
-0048	-0268	5												
-0049	-0269	20	750	10	4	16	50	0.88	23	-80	25	25	2360	T4
-0050	-0270	10												
-0051	-0271	5												
-0052	-0272	20	70	15	1	4	13	2.46	75	-28	14	16	1150	T2
-0053	-0273	10												
-0054	-0274	5												
-0055	-0275	20	120	15	1	7	18	1.99	50	-28	17.5	20	1450	T2
-0056	-0276	10												
-0057	-0277	5												
-0058	-0278	20	170	15	2	10	25	1.95	35	-32	14	16	1480	T3
-0059	-0279	10												
-0060	-0280	5												
-0061	-0281	20	270	15	2	16	32	1.57	30	-56	17.5	20	1740	T3
-0062	-0282	10												
-0063	-0283	5												
-0064	-0284	20	540	15	6	24	40	0.98	23	-80	25	25	2330	T4
-0065	-0285	10												
-0066	-0286	5												
-0067	-0287	20	50	25	1	2	11	2.92	70	-28	13	15	1130	T2
-0068	-0288	10												
-0069	-0289	5												
-0070	-0290	20	100	25	1	10	15	1.99	50	-28	13	15	1435	T2
-0071	-0291	10												
-0072	-0292	5												
-0073	-0293	20	120	25	2	6	21	2.32	38	-32	13	15	1450	T3
-0074	-0294	10												
-0075	-0295	5												
-0076	-0296	20	180	25	2	18	26	1.92	32	-48	13	15	1525	T3
-0077	-0297	10												
-0078	-0298	5												
-0079	-0299	20												
-0080	-0300	10												
-0081	-0301	20												
-0082	-0302	10												
-0083	-0303	5												
-0084	-0304	20												
-0085	-0305	10												
-0086	-0306	5												
-0087	-0307	20												
-0088	-0308	10												
-0089	-0309	5												
-0090	-0310	20												
-0091	-0311	10												
-0092	-0312	5												
-0093	-0313	20												
-0094	-0314	10												
-0095	-0315	5												
-0096	-0316	20												
-0097	-0317	10												
-0098	-0318	5												

All technical data relates to an ambient temperature of +25°C. Capacitance and DF are measured at 120Hz, 0.5RMS with DC bias of 2.2V. DCL is measured at rated voltage after 5 minutes.

130 The Important Information/Disclaimer is incorporated in the catalog where these specifications came from or available online at www.kyocera-avx.com/disclaimer/ by reference and should be reviewed in full before placing any order.

TDS-HIRELTANT-0012 | Rev 1

TWC SERIES

MIL-PRF-39006 Series – Military Conventional Wet Tantalum



M39006/22 Dashes		Tolerance ± (%)	Cap (µF) 25°C at 120Hz	DC Rated Voltage (V) at 85°C	DC Leakage (µA)		DF max (%)	ESR max (Ohms) at 120Hz	Impedance max (Ohms) -55°C at 120Hz	Maximum Capacitance Change (%)			AC Ripple (mA rms) 85°C at 40kHz	Case Size
M Level	P Level				+25°C	+85°C & +125°C				-55°C	+85°C	+125°C		
-0099	-0319	20	350	25	7	28	35	1.33	24	-70	25	25	1970	T4
-0100	-0320	10												
-0107	-0327	20												
-0108	-0328	10	40	30	1	5	10	3.32	65	-24	10.5	12	1120	T2
-0109	-0329	5												
-0110	-0330	20												
-0111	-0331	10	68	30	1	8	13	2.54	60	-24	13	15	1285	T2
-0112	-0332	5												
-0113	-0333	20												
-0114	-0334	10	100	30	2	12	17	2.26	40	-28	10.5	12	1450	T3
-0115	-0335	5												
-0116	-0336	20												
-0117	-0337	10	150	30	2	18	23	2.03	35	-48	13	15	1525	T3
-0118	-0338	5												
-0119	-0339	20												
-0120	-0340	10	300	30	8	32	31	1.37	25	-60	25	25	1950	T4
-0127	-0347	20												
-0128	-0348	10												
-0129	-0349	5	25	50	1	5	8	4.25	95	-20	10.5	12	1005	T2
-0130	-0350	20												
-0131	-0351	10												
-0132	-0352	5	47	50	1	9	11	3.11	70	-28	13	15	1155	T2
-0133	-0353	20												
-0134	-0354	10												
-0135	-0355	5	60	50	2	12	12	2.65	45	-16	10.5	12	1335	T3
-0136	-0356	20												
-0137	-0357	10												
-0138	-0358	5	82	50	2	16	15	2.43	45	-32	13	15	1400	T3
-0139	-0359	20												
-0140	-0360	10												
-0147	-0367	20	160	50	8	32	17	1.41	27	-50	25	25	1900	T4
-0148	-0368	10												
-0149	-0369	5												
-0150	-0370	20	20	60	1	5	7	4.64	105	-16	10.5	12	930	T2
-0151	-0371	10												
-0152	-0372	5												
-0153	-0373	20	39	60	1	9	10	3.4	90	-28	10.5	12	1110	T2
-0154	-0374	10												
-0155	-0375	5												
-0156	-0376	20	50	60	2	12	10	2.65	50	-16	10.5	12	1330	T3
-0157	-0377	10												
-0158	-0378	5												
-0159	-0379	20	68	60	2	16	13	2.54	50	-32	10.5	12	1365	T3
-0160	-0380	10												
-0167	-0387	20												
-0168	-0388	10	140	60	8	32	16	1.52	28	-40	20	20	1850	T4
-0169	-0389	5												
-0170	-0390	20												
-0171	-0391	10	15	75	1	5	6	5.31	150	-16	8	9	890	T2
-0172	-0392	5												
-0173	-0393	20												
-0174	-0394	10	33	75	1	10	10	4.02	90	-24	10.5	15	1000	T2
-0177	-0397	10												
-0178	-0398	5												
-0179	-0399	20	40	75	2	12	9	2.99	60	-16	10.5	12	1250	T3
-0180	-0400	10												
-0187	-0407	20												
-0188	-0408	10	56	75	2	17	11	2.61	60	-28	10.5	15	1335	T3
-0189	-0409	5												
-0190	-0410	20												
-0191	-0411	10	110	75	9	36	12	1.45	29	-35	20	20	1850	T4
-0192	-0412	5												
-0193	-0413	20												
-0194	-0414	10	11	100	1	4	5	6.03	200	-16	8	8	835	T2
-0195	-0415	5												
-0196	-0416	20												
-0197	-0417	10	22	100	1	9	7.5	4.52	100	-16	8	8	965	T2
-0198	-0418	5												
-0199	-0419	20												
-0200	-0420	10	30	100	2	12	7	3.1	80	-16	8	8	1240	T3
-0199	-0419	20												
-0200	-0420	10												
-0197	-0417	10	43	100	2	17	8.5	2.62	70	-20	8	8	1335	T3
-0198	-0418	5												
-0199	-0419	20												
-0200	-0420	10	86	100	9	36	10	1.54	30	-25	15	15	1800	T4
-0199	-0419	20												
-0200	-0420	10												

All technical data relates to an ambient temperature of +25°C. Capacitance and DF are measured at 120Hz, 0.5RMS with DC bias of 2.2V. DCL is measured at rated voltage after 5 minutes.

TWC SERIES

MIL-PRF-39006 Series – Military Conventional Wet Tantalum



M39006 /25 RATINGS AND DASH NUMBER REFERENCE

M39006/25 Dashes		Tolerance ± (%)	Cap (µF) 25°C at 120Hz	DC Rated Voltage (V) at 85°C	DC Leakage (µA)		DF max (%)	ESR max (Ohms) at 120Hz	Impedance max (Ohms) -55°C at 120Hz	Maximum Capacitance Change (%)			AC Ripple (mA rms) 85°C at 40kHz	Case Size
M Level	P Level				+25°C	+85°C & +125°C				-55°C	+85°C	+125°C		
-0003	-0091	20	820	6	3	14	155	2.51	18	-88	16	20	1500	T2
-0004	-0092	10												
-0005	-0093	20	1500	6	5	20	172	1.52	18	-90	20	25	1900	T3
-0006	-0094	10												
-0007	-0095	20	2200	6	6	24	170	1.03	13	-90	25	30	2300	T4
-0008	-0096	10												
-0011	-0099	20	680	8	3	14	130	2.54	22	-83	16	20	1500	T2
-0012	-0100	10												
-0013	-0101	20	1500	8	5	20	170	1.5	18	-90	20	25	1900	T3
-0014	-0102	10												
-0015	-0103	20	1800	8	7	25	138	1.02	14	-90	25	30	2300	T4
-0016	-0104	10												
-0019	-0107	20	560	10	3	16	106	2.51	27	-77	16	20	1450	T2
-0020	-0108	10												
-0021	-0109	20	1200	10	5	20	137	1.51	18	-88	20	25	1850	T3
-0022	-0110	10												
-0023	-0111	20	1500	10	7	25	114	1.01	15	-88	25	30	2300	T4
-0024	-0112	10												
-0027	-0115	20	390	15	3	16	74	2.52	31	-66	16	20	1450	T2
-0028	-0116	10												
-0029	-0117	20	820	15	6	24	111	1.8	22	-77	20	25	1800	T3
-0030	-0118	10												
-0031	-0119	20	1000	15	8	32	92	1.22	17	-77	25	30	2300	T4
-0032	-0120	10												
-0035	-0123	20	270	25	3	16	55	2.7	33	-62	13	16	1400	T2
-0036	-0124	10												
-0037	-0125	20	560	25	7	28	76	1.8	24	-72	20	25	1750	T3
-0038	-0126	10												
-0039	-0127	20	680	25	8	32	63	1.23	19	-72	25	30	2100	T4
-0040	-0128	10												
-0043	-0131	20	220	30	3	16	42	2.53	36	-60	13	16	1200	T2
-0044	-0132	10												
-0045	-0133	20	470	30	8	32	64	1.81	25	-65	20	25	1500	T3
-0046	-0134	10												
-0047	-0135	20	560	30	9	36	55	1.3	20	-65	25	30	2000	T4
-0048	-0136	10												
-0051	-0139	20	120	50	4	24	22.5	2.49	49	-42	12	15	1200	T2
-0052	-0140	10												
-0053	-0141	20	270	50	8	32	37	1.82	29	-46	20	25	1450	T3
-0054	-0142	10												
-0055	-0143	20	330	50	9	36	38	1.53	22	-46	25	30	1900	T4
-0056	-0144	10												
-0059	-0147	20	100	60	4	20	19	2.52	54	-36	12	15	1100	T2
-0060	-0148	10												
-0061	-0149	20	220	60	8	32	30	1.81	29	-40	16	20	1400	T3
-0062	-0150	10												
-0063	-0151	20	270	60	9	36	27	1.33	23	-45	20	25	1850	T4
-0064	-0152	10												
-0067	-0155	20	82	75	4	24	15.2	2.46	63	-30	12	15	1000	T2
-0068	-0156	10												
-0069	-0157	20	180	75	9	36	24.4	2.23	30	-35	16	20	1300	T3
-0070	-0158	10												
-0071	-0159	20	220	75	10	40	37	1.8	24	-40	20	25	1800	T4
-0072	-0160	10												
-0075	-0163	20	39	100	5	24	10.4	3.54	80	-20	12	15	1300	T2
-0076	-0164	10												
-0077	-0165	20	68	100	10	40	11.3	2.21	40	-30	14	16	1600	T3
-0078	-0166	10												
-0079	-0167	20	120	100	12	48	25	2.76	30	-35	15	17	2000	T4
-0080	-0168	10												

All technical data relates to an ambient temperature of +25°C. Capacitance and DF are measured at 120Hz, 0.5RMS with DC bias of 2.2V. DCL is measured at rated voltage after 5 minutes.

TWC SERIES

MIL-PRF-39006 Series – Military Conventional Wet Tantalum



M39006 /30 RATINGS AND DASH NUMBER REFERENCE

M39006/30 Dashes		Tolerance ± (%)	Cap (µF) 25°C at 120Hz	DC Rated Voltage (V) at 85°C	DC Leakage (µA)		DF max (%)	ESR max (Ohms) at 120Hz	Impedance max (Ohms) -55°C at 120Hz	Maximum Capacitance Change (%)			AC Ripple (mA rms) 85°C at 40kHz	Case Size
M Level	P Level				+25°C	+85°C & +125°C				-55°C	+85°C	+125°C		
-0007	-0227	20	140	6	1	3	10.5	0.99	40	-40	14	16	1200	T2
-0008	-0228	10												
-0009	-0229	5												
-0010	-0230	20	270	6	1	6.5	22.5	1.11	25	-44	17.5	20	1375	T2
-0011	-0231	10												
-0012	-0232	5												
-0013	-0233	20	330	6	2	7.9	18	0.73	20	-44	14	16	1800	T3
-0014	-0234	10												
-0015	-0235	5												
-0016	-0236	20	560	6	2	13	27.5	0.65	25	-64	17.5	20	1900	T3
-0017	-0237	10												
-0018	-0238	5												
-0019	-0239	20	1200	6	3	14	45	0.5	20	-80	25	25	2265	T4
-0020	-0240	10												
-0027	-0247	20												
-0028	-0248	10	120	8	1	2	10	1.11	50	-44	17.5	20	1220	T2
-0029	-0249	5												
-0030	-0250	20												
-0031	-0251	10	220	8	1	7	18.5	1.12	30	-44	17.5	20	1370	T2
-0032	-0252	5												
-0033	-0253	20												
-0034	-0254	10	290	8	2	6	17	0.78	25	-64	17.5	20	1770	T3
-0035	-0255	5												
-0036	-0256	20												
-0037	-0257	10	430	8	2	14	23	0.71	25	-64	17.5	20	1825	T3
-0038	-0258	5												
-0039	-0259	20												
-0040	-0260	10	850	8	4	16	30	0.47	22	-80	25	25	2330	T4
-0047	-0267	20												
-0048	-0268	10												
-0049	-0269	5	100	10	1	4	7.5	0.99	60	-36	14	16	1200	T2
-0050	-0270	20												
-0051	-0271	10												
-0052	-0272	5	180	10	1	7	15	1.11	40	-36	14	16	1.365	T2
-0053	-0273	20												
-0054	-0274	10												
-0055	-0275	5	250	10	2	10	15	0.8	30	-40	14	16	1720	T3
-0056	-0276	20												
-0057	-0277	10												
-0058	-0278	5	390	10	2	16	22	0.75	25	-64	17.5	20	1800	T3
-0059	-0279	20												
-0060	-0280	10												
-0067	-0287	20	70	15	1	4	6.5	1.23	75	-28	14	16	1150	T2
-0068	-0288	10												
-0069	-0289	5												
-0070	-0290	20	120	15	1	7	9	0.99	50	-28	17.5	20	1450	T2
-0071	-0291	10												
-0072	-0292	5												
-0073	-0293	20	170	15	2	10	12.5	0.98	35	-32	14	16	1480	T3
-0074	-0294	10												
-0075	-0295	5												
-0076	-0296	20	270	15	2	16	16	0.79	30	-56	17.5	20	1740	T3
-0077	-0297	10												
-0078	-0298	5												
-0079	-0299	20	540	15	6	24	20	0.49	23	-80	25	25	2330	T4
-0080	-0300	10												
-0087	-0307	20												
-0088	-0308	10	50	25	1	2	5.5	1.46	70	-28	13	15	1130	T2
-0089	-0309	5												
-0090	-0310	20												
-0091	-0311	10	100	25	1	10	7.5	0.99	50	-28	13	15	1435	T2
-0092	-0312	5												
-0093	-0313	20												
-0094	-0314	10	120	25	2	6	10.5	1.16	38	-32	13	15	1450	T3
-0095	-0315	5												
-0096	-0316	20												
-0097	-0317	10	180	25	2	18	13	0.96	32	-48	13	15	1525	T3
-0098	-0318	5												

All technical data relates to an ambient temperature of +25°C. Capacitance and DF are measured at 120Hz, 0.5RMS with DC bias of 2.2V. DCL is measured at rated voltage after 5 minutes.

TWC SERIES

MIL-PRF-39006 Series – Military Conventional Wet Tantalum



M39006/30 Dashes		Tolerance ± (%)	Cap (µF) 25°C at 120Hz	DC Rated Voltage (V) at 85°C	DC Leakage (µA)		DF max (%)	ESR max (Ohms) at 120Hz	Impedance max (Ohms) -55°C at 120Hz	Maximum Capacitance Change (%)			AC Ripple (mA rms) 85°C at 40kHz	Case Size
M Level	P Level				+25°C	+85°C & +125°C				-55°C	+85°C	+125°C		
-0099	-0319	20	350	25	7	28	17.5	0.67	24	-70	25	25	1970	T4
-0100	-0320	10												
-0107	-0327	20												
-0108	-0328	10	40	30	1	5	5	1.66	65	-24	10.5	12	1120	T2
-0109	-0329	5												
-0110	-0330	20												
-0111	-0331	10	68	30	1	8	6.5	1.27	60	-24	13	15	1285	T2
-0112	-0332	5												
-0113	-0333	20												
-0114	-0334	10	100	30	2	12	8.5	1.13	40	-28	10.5	12	1450	T3
-0115	-0335	5												
-0116	-0336	20												
-0117	-0337	10	150	30	2	18	11.5	1.02	35	-48	13	15	1525	T3
-0118	-0338	5												
-0119	-0339	20												
-0120	-0340	10	300	30	8	32	15.5	0.69	25	-60	25	25	1950	T4
-0127	-0347	20												
-0128	-0348	10												
-0129	-0349	5	25	50	1	5	4	2.13	95	-20	10.5	12	1005	T2
-0130	-0350	20												
-0131	-0351	10												
-0132	-0352	5	47	50	1	9	5.5	1.56	70	-28	13	15	1155	T2
-0133	-0353	20												
-0134	-0354	10												
-0135	-0355	5	60	50	2	12	6	1.33	45	-16	10.5	12	1335	T3
-0136	-0356	20												
-0137	-0357	10												
-0138	-0358	5	82	50	2	16	7.5	1.22	45	-32	13	15	1400	T3
-0139	-0359	20												
-0140	-0360	10												
-0147	-0367	20	160	50	8	32	8.5	0.71	27	-50	25	25	1900	T4
-0148	-0368	10												
-0149	-0369	5												
-0150	-0370	20	20	60	1	5	3.5	2.32	105	-16	10.5	12	930	T2
-0151	-0371	10												
-0152	-0372	5												
-0153	-0373	20	39	60	1	9	5	1.7	90	-28	10.5	12	1110	T2
-0154	-0374	10												
-0155	-0375	5												
-0156	-0376	20	50	60	2	12	5	1.33	50	-16	10.5	12	1330	T3
-0157	-0377	10												
-0158	-0378	5												
-0159	-0379	20	68	60	2	16	6.5	1.27	50	-32	10.5	12	1365	T3
-0160	-0380	10												
-0167	-0387	20												
-0168	-0388	10	140	60	8	32	8	0.76	28	-40	20	20	1850	T4
-0169	-0389	5												
-0170	-0390	20												
-0171	-0391	10	15	75	1	5	3	2.66	150	-16	8	9	890	T2
-0172	-0392	5												
-0173	-0393	20												
-0174	-0394	10	33	75	1	10	5	2.01	90	-24	10.5	15	1000	T2
-0175	-0395	5												
-0176	-0396	20												
-0177	-0397	10	40	75	2	12	4.5	1.5	60	-16	10.5	12	1250	T3
-0178	-0398	5												
-0179	-0399	20												
-0180	-0400	10	56	75	2	17	5.5	1.31	60	-28	10.5	15	1335	T3
-0187	-0407	20												
-0188	-0408	10												
-0189	-0409	5	110	75	9	36	6	0.73	29	-35	20	20	1850	T4
-0190	-0410	20												
-0191	-0411	10												
-0192	-0412	5	11	100	1	4	2.5	3.02	200	-16	8	8	835	T2
-0193	-0413	20												
-0194	-0414	10												
-0195	-0415	5	22	100	1	9	3.75	2.26	100	-16	8	8	965	T2
-0196	-0416	20												
-0197	-0417	10												
-0198	-0418	5	30	100	2	12	3.5	1.55	80	-16	8	8	1240	T3
-0199	-0419	20												
-0200	-0420	10												

All technical data relates to an ambient temperature of +25°C. Capacitance and DF are measured at 120Hz, 0.5RMS with DC bias of 2.2V. DCL is measured at rated voltage after 5 minutes.

TWC SERIES

MIL-PRF-39006 Series – Military Conventional Wet Tantalum



M39006 /31 RATINGS AND DASH NUMBER REFERENCE

M39006/31 Dashes		Tolerance ± (%)	Cap (µF) 25°C at 120Hz	DC Rated Voltage (V) at 85°C	DC Leakage (µA)		DF max (%)	ESR max (Ohms) at 120Hz	Impedance max (Ohms) -55°C at 120Hz	Maximum Capacitance Change (%)			AC Ripple (mA rms) 85°C at 40kHz	Case Size
M Level	P Level				+25°C	+85°C & +125°C				-55°C	+85°C	+125°C		
-0003	-0091	20	820	6	3	14	77.5	1.26	18	-88	16	20	1500	T2
-0004	-0092	10												
-0005	-0093	20	1500	6	5	20	86	0.76	18	-90	20	25	1900	T3
-0006	-0094	10												
-0007	-0095	20	2200	6	6	24	85	0.52	13	-90	25	30	2300	T4
-0008	-0096	10												
-0011	-0099	20	680	8	3	14	65	1.27	22	-83	16	20	1500	T2
-0012	-0100	10												
-0013	-0101	20	1500	8	5	20	85	0.75	18	-90	20	25	1900	T3
-0014	-0102	10												
-0015	-0103	20	1800	8	7	25	69	0.51	14	-90	25	30	2300	T4
-0016	-0104	10												
-0019	-0107	20	560	10	3	16	53	1.26	27	-77	16	20	1450	T2
-0020	-0108	10												
-0021	-0109	20	1200	10	5	20	68.5	0.76	18	-88	20	25	1850	T3
-0022	-0110	10												
-0023	-0111	20	1500	10	7	25	57	0.51	15	-88	25	30	2300	T4
-0024	-0112	10												
-0027	-0115	20	390	15	3	16	37	1.26	31	-66	16	20	1450	T2
-0028	-0116	10												
-0029	-0117	20	820	15	6	24	55.5	0.9	22	-77	20	25	1800	T3
-0030	-0118	10												
-0031	-0119	20	1000	15	8	32	46	0.61	17	-77	25	30	2300	T4
-0032	-0120	10												
-0035	-0123	20	270	25	3	16	27.5	1.35	33	-62	13	16	1400	T2
-0036	-0124	10												
-0037	-0125	20	560	25	7	28	38	0.9	24	-72	20	25	1750	T3
-0038	-0126	10												
-0039	-0127	20	680	25	8	32	31.5	0.62	19	-72	25	30	2100	T4
-0040	-0128	10												
-0043	-0131	20	220	30	3	16	21	1.27	36	-60	13	16	1200	T2
-0044	-0132	10												
-0045	-0133	20	470	30	8	32	32	0.91	25	-65	20	25	1500	T3
-0046	-0134	10												
-0047	-0135	20	560	30	9	36	27.5	0.65	20	-65	25	30	2000	T4
-0048	-0136	10												
-0051	-0139	20	120	50	4	24	11.3	1.25	49	-42	12	15	1200	T2
-0052	-0140	10												
-0053	-0141	20	270	50	8	32	18.5	0.91	29	-46	20	25	1450	T3
-0054	-0142	10												
-0055	-0143	20	330	50	9	36	19	0.77	22	-46	25	30	1900	T4
-0056	-0144	10												
-0059	-0147	20	100	60	4	20	9.5	1.26	54	-36	12	15	1100	T2
-0060	-0148	10												
-0061	-0149	20	220	60	8	32	15	0.91	29	-40	16	20	1400	T3
-0062	-0150	10												
-0063	-0151	20	270	60	9	36	13.5	0.67	23	-45	20	25	1850	T4
-0064	-0152	10												
-0067	-0155	20	82	75	4	24	7.6	1.23	63	-30	12	15	1000	T2
-0068	-0156	10												
-0069	-0157	20	180	75	9	36	12.2	0.9	30	-35	16	20	1300	T3
-0070	-0158	10												
-0071	-0159	20	220	75	10	40	18.5	1.12	24	-40	20	25	1800	T4
-0072	-0160	10												
-0075	-0163	20	39	100	5	24	5.2	1.77	80	-20	12	15	1300	T2
-0076	-0164	10												
-0077	-0165	20	68	100	10	40	5.65	1.11	40	-30	14	16	1600	T3
-0078	-0166	10												
-0079	-0167	20	120	100	12	48	12.5	1.38	30	-35	15	17	2000	T4
-0080	-0168	10												

All technical data relates to an ambient temperature of +25°C. Capacitance and DF are measured at 120Hz, 0.5RMS with DC bias of 2.2V. DCL is measured at rated voltage after 5 minutes.

TWC SERIES

COTS-Plus – Conventional Wet Tantalum

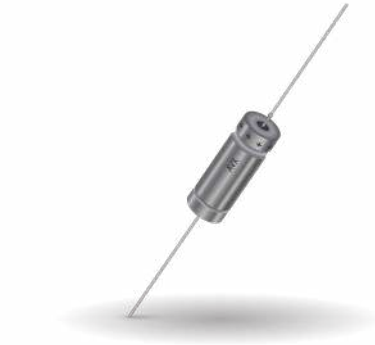

The TWC series represents a COTS-Plus version of conventional wet electrolytic tantalum capacitors. This data sheet incorporates all ratings available in MIL-PRF-39006 /22 /25 /30 and /31. Contact the factory about cap and voltage design possibilities beyond those contained in this datasheet.

This design includes a welded tantalum can and header assembly that provides a hermetic seal to withstand harsh environments and includes selected Group A testing from MIL-PRF-39006.

For military qualified versions please refer to the MIL-PRF-39006 datasheet located on the KYOCERA AVX website.

OUTLINE DIMENSIONS

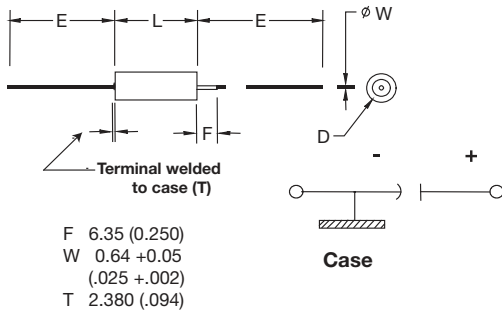

CASE DIMENSIONS: millimeters (inches)

DLA Case Size	Case Size	L +0.79 (0.031) -0.41 (0.016)	D Basic Case ±0.41 (0.016)	D Insulated Case Max	E ±6.35 (0.250)
T1	A	11.51 (0.453)	4.78 (0.188)	5.56 (0.219)	38.10 (1.500)
T2	B	16.28 (0.641)	7.14 (0.281)	7.92 (0.312)	57.15 (2.250)
T3	D	19.46 (0.766)	9.52 (0.375)	10.31 (0.406)	57.15 (2.250)
T4	E	26.97 (1.062)	9.52 (0.375)	10.31 (0.406)	57.15 (2.250)

VOLTAGE RATINGS (Operating Temperature -55°C to 125°C)

Voltage (DC)		6	8	10	15	25	30	50	60	75	100	125
Rated Voltage: (V _r)	85°C											
Derated Voltage: (V _d)	125°C	4	5	6	10	15	20	30	40	50	65	85
Surge Voltage: (V _s)	85°C	6.9	9.2	11.5	17.3	28.8	34.5	57.5	69	86.3	115	144

TWC SERIES

COTS-Plus – Conventional Wet Tantalum

HOW TO ORDER

PART NUMBER:

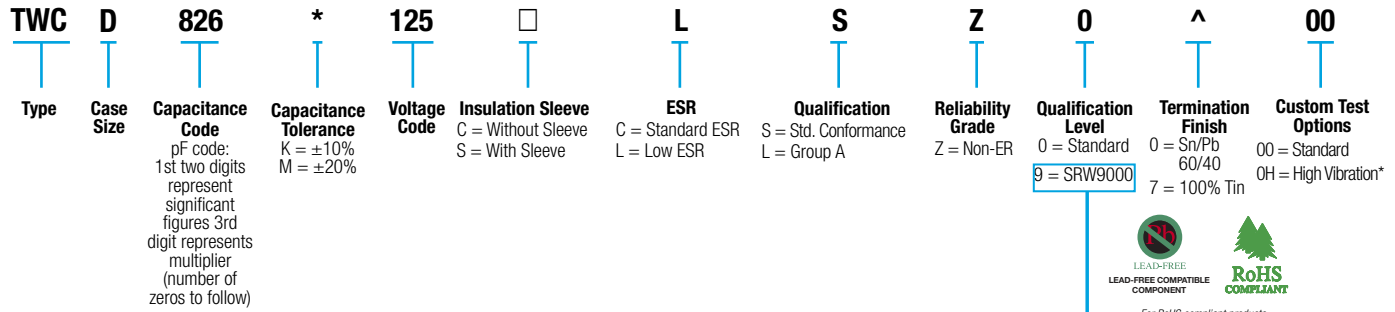

*High vibration qualified parts are currently under development. Please contact the factory for additional details and availability.

SPACE LEVEL OPTIONS TO SRW9000*:

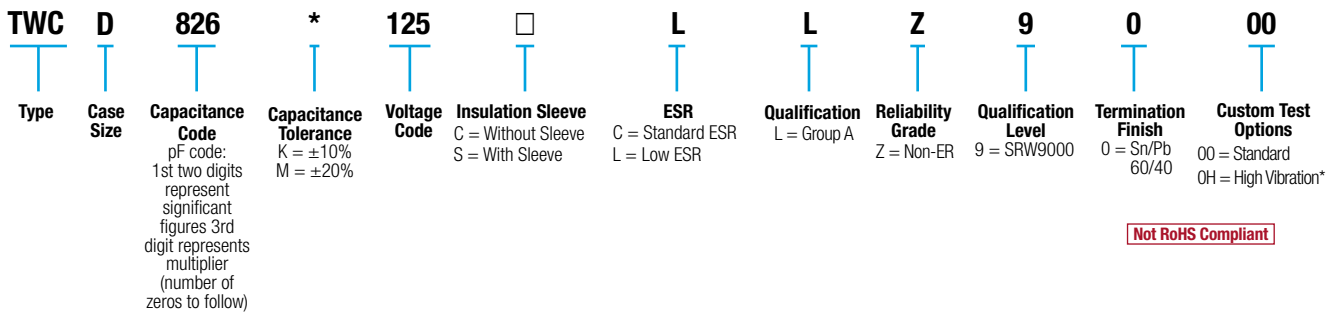

*Check with factory for availability and testing details.

RIPPLE CURRENT MULTIPLIERS vs. Frequency, temperature and applied voltage^{1/2}

Frequency of Applied Ripple Current	120Hz				800Hz				1kHz				
	Ambient Still Air Temperature (°C)	≤55	85	105	125	≤55	85	105	125	≤55	85	105	125
% of Rated	100%	0.60	0.39	–	–	0.71	0.43	–	–	0.72	0.45	–	–
Peak Voltage	90%	0.60	0.46	–	–	0.71	0.55	–	–	0.72	0.55	–	–
	80%	0.60	0.52	0.35	–	0.71	0.62	0.42	–	0.72	0.62	0.42	–
	70%	0.60	0.58	0.44	–	0.71	0.69	0.52	–	0.72	0.70	0.52	–
66-2/3%	0.60	0.60	0.46	0.27	0.71	0.71	0.55	0.32	0.72	0.72	0.55	0.32	

Frequency of Applied Ripple Current	10kHz				40kHz				100kHz				
	Ambient Still Air Temperature (°C)	≤55	85	105	125	≤55	85	105	125	≤55	85	105	125
% of Rated	100%	0.88	0.55	–	–	1.00	0.63	–	–	1.10	0.69	–	–
Peak Voltage	90%	0.88	0.67	–	–	1.00	0.77	–	–	1.10	0.85	–	–
	80%	0.88	0.76	0.52	–	1.00	0.87	0.59	–	1.10	0.96	0.65	–
	70%	0.88	0.85	0.64	–	1.00	0.97	0.73	–	1.10	1.07	0.80	–
66-2/3%	0.88	0.88	0.68	0.40	1.00	1.00	0.77	0.45	1.10	1.10	0.85	0.50	

1/ At 125°C the rated voltage of the capacitors decreases to 66 2/3 of the 85°C rated voltage.

2/ The peak of the applied ac ripple voltage plus the applied dc voltage must not exceed the dc voltage rating of the capacitors.

TWC SERIES

COTS-Plus – Conventional Wet Tantalum

STANDARD RATINGS & PART NUMBER REFERENCE

Part Number	Cap (µF) 25°C at 120Hz	DC Rated Voltage (V) at 85°C	DC Leakage (µA)		DF (Max)	ESR Max (Ohms) at 120Hz	Impedance max (Ohms) -55°C at 120Hz	Maximum Capacitance Change (%)			AC Ripple (mA rms) 85°C at 40kHz	Case Size	
			+25°C	+85°C & +125°C				-55°C	+85°C	+125°C		Standard	AVX
TWCA306*006□CSZ0^00	30	6	1	2	9	3.98	100	-40	10.5	12	820	T1	A
TWCA306*006□LSZ0^00					4.5	1.99							
TWCA686*006□CSZ0^00	68	6	1	2	15	3.16	60	-40	14	16	960	T1	A
TWCA686*006□LSZ0^00					7.5	1.58							
TWCB147*006□CSZ0^00	140	6	1	3	21	1.99	40	-40	14	16	1,200	T2	B
TWCB147*006□LSZ0^00					10.5	0.99							
TWCB277*006□CSZ0^00	270	6	1	6.5	45	2.21	25	-44	17.5	20	1,375	T2	B
TWCB277*006□LSZ0^00					22.5	1.11							
TWCD337*006□CSZ0^00	330	6	2	7.9	36	1.45	20	-44	14	16	1,800	T3	D
TWCD337*006□LSZ0^00					18	0.73							
TWCD567*006□CSZ0^00	560	6	2	13	55	1.3	25	-64	17.5	20	1,900	T3	D
TWCD567*006□LSZ0^00					27.5	0.65							
TWCE128*006□CSZ0^00	1,200	6	3	14	90	1	20	-80	25	25	2,265	T4	E
TWCE128*006□LSZ0^00					45	0.5							
TWCA256*008□CSZ0^00	25	8	1	2	7.5	3.98	100	-40	10.5	12	820	T1	A
TWCA256*008□LSZ0^00					3.75	1.99							
TWCA566*008□CSZ0^00	56	8	1	2	14	3.32	59	-40	14	16	900	T1	A
TWCA566*008□LSZ0^00					7	1.66							
TWCB127*008□CSZ0^00	120	8	1	2	20	2.21	50	-44	17.5	20	1,220	T2	B
TWCB127*008□LSZ0^00					10	1.11							
TWCB227*008□CSZ0^00	220	8	1	7	37	2.23	30	-44	17.5	20	1,370	T2	B
TWCB227*008□LSZ0^00					18.5	1.12							
TWCD297*008□CSZ0^00	290	8	2	6	34	1.56	25	-64	17.5	20	1,770	T3	D
TWCD297*008□LSZ0^00					17	0.78							
TWCD437*008□CSZ0^00	430	8	2	14	46	1.42	25	-64	17.5	20	1,825	T3	D
TWCD437*008□LSZ0^00					23	0.71							
TWCE857*008□CSZ0^00	850	8	4	16	60	0.94	22	-80	25	25	2,330	T4	E
TWCE857*008□LSZ0^00					30	0.47							
TWCA206*010□CSZ0^00	20	10	1	2	6	3.98	175	-32	10.5	12	820	T1	A
TWCA206*010□LSZ0^00					3	1.99							
TWCA476*010□CSZ0^00	47	10	1	2	13	3.67	100	-36	14	16	855	T1	A
TWCA476*010□LSZ0^00					6.5	1.84							
TWCB107*010□CSZ0^00	100	10	1	4	15	1.99	60	-36	14	16	1,200	T2	B
TWCB107*010□LSZ0^00					7.5	0.99							
TWCB187*010□CSZ0^00	180	10	1	7	30	2.21	40	-36	14	16	1,365	T2	B
TWCB187*010□LSZ0^00					15	1.11							
TWCD257*010□CSZ0^00	250	10	2	10	30	1.59	30	-40	14	16	1,720	T3	D
TWCD257*010□LSZ0^00					15	0.8							
TWCD397*010□CSZ0^00	390	10	2	16	44	1.5	25	-64	17.5	20	1,800	T3	D
TWCD397*010□LSZ0^00					22	0.75							
TWCE757*010□CSZ0^00	750	10	4	16	50	0.88	23	-80	25	25	2,360	T4	E
TWCE757*010□LSZ0^00					25	0.44							
TWCA156*015□CSZ0^00	15	15	1	2	5	4.42	155	-24	10.5	12	780	T1	A
TWCA156*015□LSZ0^00					2.5	2.21							
TWCA336*015□CSZ0^00	33	15	1	2	10	4.02	90	-28	14	16	820	T1	A
TWCA336*015□LSZ0^00					5	2.01							
TWCB706*015□CSZ0^00	70	15	1	4	13	2.46	75	-28	14	16	1,150	T2	B
TWCB706*015□LSZ0^00					6.5	1.23							
TWCB127*015□CSZ0^00	120	15	1	7	18	1.99	50	-28	17.5	20	1,450	T2	B
TWCB127*015□LSZ0^00					9	0.99							
TWCD177*015□CSZ0^00	170	15	2	10	25	1.95	35	-32	14	16	1,480	T3	D
TWCD177*015□LSZ0^00					12.5	0.98							
TWCD277*015□CSZ0^00	270	15	2	16	32	1.57	30	-56	17.5	20	1,740	T3	D
TWCD277*015□LSZ0^00					16	0.79							
TWCE547*015□CSZ0^00	540	15	6	24	40	0.98	23	-80	25	25	2,330	T4	E
TWCE547*015□LSZ0^00					20	0.49							
TWCA106*025□CSZ0^00	10	25	1	2	4	5.31	220	-16	8	9	715	T1	A
TWCA106*025□LSZ0^00					2	2.66							
TWCA226*025□CSZ0^00	22	25	1	2	6.6	3.98	140	-20	10.5	12	825	T1	A
TWCA226*025□LSZ0^00					3.3	1.99							
TWCB506*025□CSZ0^00	50	25	1	2	11	2.92	70	-28	13	15	1,130	T2	B
TWCB506*025□LSZ0^00					5.5	1.46							

All technical data relates to an ambient temperature of +25°C. Capacitance and DF are measured at 120Hz, 0.5RMS with DC bias of 2.2V. DCL is measured at rated voltage after 5 minutes.

NOTE: KYOCERA AVX reserves the rights to supply higher voltage rating in the same case size, to the same reliability standards.

TWC SERIES

COTS-Plus – Conventional Wet Tantalum

STANDARD RATINGS & PART NUMBER REFERENCE

Part Number	Cap (µF) 25°C at 120Hz	DC Rated Voltage (V) at 85°C	DC Leakage (µA)		DF (Max)	ESR Max (Ohms) at 120Hz	Impedance max (Ohms) -55°C at 120Hz	Maximum Capacitance Change (%)			AC Ripple (mA rms) 85°C at 40kHz	Case Size	
			+25°C	+85°C & +125°C				-55°C	+85°C	+125°C		Standard	AVX
TWCB107*025□CSZ0^00	100	25	1	10	15	1.99	50	-28	13	15	1,435	T2	B
TWCB107*025□LSZ0^00					7.5	0.99							
TWCD127*025□CSZ0^00	120	25	2	6	21	2.32	38	-32	13	15	1,450	T3	D
TWCD127*025□LSZ0^00					10.5	1.16							
TWCD187*025□CSZ0^00	180	25	2	18	26	1.92	32	-48	13	15	1,525	T3	D
TWCD187*025□LSZ0^00					13	0.96							
TWCE357*025□CSZ0^00	350	25	7	28	35	1.33	24	-70	25	25	1,970	T4	E
TWCE357*025□LSZ0^00					17.5	0.67							
TWCA805*030□CSZ0^00	8	30	1	2	4	6.64	275	-16	8	12	640	T1	A
TWCA805*030□LSZ0^00					2	3.32							
TWCA156*030□CSZ0^00	15	30	1	2	5	4.42	175	-20	10.5	12	780	T1	A
TWCA156*030□LSZ0^00					2.5	2.21							
TWCB406*030□CSZ0^00	40	30	1	5	10	3.32	65	-24	10.5	12	1,120	T2	B
TWCB406*030□LSZ0^00					5	1.66							
TWCB686*030□CSZ0^00	68	30	1	8	13	2.54	60	-24	13	15	1,285	T2	B
TWCB686*030□LSZ0^00					6.5	1.27							
TWCD107*030□CSZ0^00	100	30	2	12	17	2.26	40	-28	10.5	12	1,450	T3	D
TWCD107*030□LSZ0^00					8.5	1.13							
TWCD157*030□CSZ0^00	150	30	2	18	23	2.03	35	-48	13	15	1,525	T3	D
TWCD157*030□LSZ0^00					11.5	1.02							
TWCE307*030□CSZ0^00	300	30	8	32	31	1.37	25	-60	25	25	1,950	T4	E
TWCE307*030□LSZ0^00					15.5	0.69							
TWCA505*050□CSZ0^00	5	50	1	2	3	7.96	400	-16	5	6	580	T1	A
TWCA505*050□LSZ0^00					1.5	3.98							
TWCA106*050□CSZ0^00	10	50	1	2	4	5.31	250	-24	8	9	715	T1	A
TWCA106*050□LSZ0^00					2	2.66							
TWCB256*050□CSZ0^00	25	50	1	5	8	4.25	95	-20	10.5	12	1,005	T2	B
TWCB256*050□LSZ0^00					4	2.13							
TWCB476*050□CSZ0^00	47	50	1	9	11	3.11	70	-28	13	15	1,155	T2	B
TWCB476*050□LSZ0^00					5.5	1.56							
TWCD606*050□CSZ0^00	60	50	2	12	12	2.65	45	-16	10.5	12	1,335	T3	D
TWCD606*050□LSZ0^00					6	1.33							
TWCD826*050□CSZ0^00	82	50	2	16	15	2.43	45	-32	13	15	1,400	T3	D
TWCD826*050□LSZ0^00					7.5	1.22							
TWCE167*050□CSZ0^00	160	50	8	32	17	1.41	27	-50	25	25	1,900	T4	E
TWCE167*050□LSZ0^00					8.5	0.71							
TWCA405*060□CSZ0^00	4	60	1	2	2.8	9.29	550	-16	5	6	525	T1	A
TWCA405*060□LSZ0^00					1.4	4.65							
TWCA825*060□CSZ0^00	8.2	60	1	2	4	6.47	275	-24	8	9	625	T1	A
TWCA825*060□LSZ0^00					2	3.24							
TWCB206*060□CSZ0^00	20	60	1	5	7	4.64	105	-16	10.5	12	930	T2	B
TWCB206*060□LSZ0^00					3.5	2.32							
TWCB396*060□CSZ0^00	39	60	1	9	10	3.4	90	-28	10.5	12	1,110	T2	B
TWCB396*060□LSZ0^00					5	1.7							
TWCD506*060□CSZ0^00	50	60	2	12	10	2.65	50	-16	10.5	12	1,330	T3	D
TWCD506*060□LSZ0^00					5	1.33							
TWCD686*060□CSZ0^00	68	60	2	16	13	2.54	50	-32	10.5	12	1,365	T3	D
TWCD686*060□LSZ0^00					7	1.27							
TWCE147*060□CSZ0^00	140	60	8	32	16	1.52	28	-40	20	20	1,850	T4	E
TWCE147*060□LSZ0^00					8	0.76							
TWCA355*075□CSZ0^00	3.5	75	1	2	2.5	9.48	650	-16	5	6	525	T1	A
TWCA355*075□LSZ0^00					1.25	4.74							
TWCA685*075□CSZ0^00	6.8	75	1	2	3.5	6.83	300	-20	8	9	610	T1	A
TWCA685*075□LSZ0^00					1.75	3.42							
TWCB156*075□CSZ0^00	15	75	1	5	6	5.31	150	-16	8	9	890	T2	B
TWCB156*075□LSZ0^00					3	2.66							
TWCB336*075□CSZ0^00	33	75	1	10	10	4.02	90	-24	10.5	15	1,000	T2	B
TWCB336*075□LSZ0^00					5	2.01							
TWCD406*075□CSZ0^00	40	75	2	12	9	2.99	60	-16	10.5	12	1,250	T3	D
TWCD406*075□LSZ0^00					4.5	1.5							
TWCD566*075□CSZ0^00	56	75	2	17	11	2.61	60	-28	10.5	15	1,335	T3	D
TWCD566*075□LSZ0^00					5.5	1.31							

All technical data relates to an ambient temperature of +25°C. Capacitance and DF are measured at 120Hz, 0.5RMS with DC bias of 2.2V. DCL is measured at rated voltage after 5 minutes.

NOTE: KYOCERA AVX reserves the rights to supply higher voltage rating in the same case size, to the same reliability standards.

TWC SERIES

COTS-Plus – Conventional Wet Tantalum

STANDARD RATINGS & PART NUMBER REFERENCE

Part Number	Cap (µF) 25°C at 120Hz	DC Rated Voltage (V) at 85°C	DC Leakage (µA)		DF (Max)	ESR Max (Ohms) at 120Hz	Impedance max (Ohms) -55°C at 120Hz	Maximum Capacitance Change (%)			AC Ripple (mA rms) 85°C at 40kHz	Case Size	
			+25°C	+85°C & +125°C				-55°C	+85°C	+125°C		Standard	AVX
TWCE117*075□CSZ0^00	110	75	9	36	12	1.45	29	-35	20	20	1,850	T4	E
TWCE117*075□LSZ0^00					6	0.73							
TWCA255*100□CSZ0^00	2.5	100	1	2	2	10.62	950	-16	7	8	505	T1	A
TWCA255*100□LSZ0^00					1	5.31							
TWCA475*100□CSZ0^00	4.7	100	1	2	3	8.47	500	-16	7	8	565	T1	A
TWCA475*100□LSZ0^00					1.5	4.24							
TWCB116*100□CSZ0^00	11	100	1	4	5	6.03	200	-16	8	8	835	T2	B
TWCB116*100□LSZ0^00					2.5	3.02							
TWCB226*100□CSZ0^00	22	100	1	9	7.5	4.52	100	-16	8	8	965	T2	B
TWCB226*100□LSZ0^00					3.75	2.26							
TWCD306*100□CSZ0^00	30	100	2	12	7	3.1	80	-16	8	8	1,240	T3	D
TWCD306*100□LSZ0^00					3.5	1.56							
TWCD436*100□CSZ0^00	43	100	2	17	8.5	2.62	70	-20	8	8	1,335	T3	D
TWCD436*100□LSZ0^00					4.25	1.31							
TWCE866*100□CSZ0^00	86	100	9	36	10	1.54	30	-25	15	15	1,800	T4	E
TWCE866*100□LSZ0^00					5	0.77							
TWCB905*125□CSZ0^00	9	125	1	5	5	7.37	240	-16	7	8	755	T2	B
TWCB905*125□LSZ0^00					2.5	3.69							
TWCD186*125□CSZ0^00	18	125	2	9	5	3.69	129	-16	7	8	1,130	T3	D
TWCD186*125□LSZ0^00					2.5	1.85							
TWCD256*125□CSZ0^00	25	125	2	13	6	3.18	93	-16	7	8	1,200	T3	D
TWCD256*125□LSZ0^00					3	1.59							
TWCE566*125□CSZ0^00	56	125	10	40	6.5	1.54	32	-25	15	15	1,800	T4	E
TWCE566*125□LSZ0^00					3.25	0.77							

All technical data relates to an ambient temperature of +25°C. Capacitance and DF are measured at 120Hz, 0.5RMS with DC bias of 2.2V. DCL is measured at rated voltage after 5 minutes.

NOTE: KYOCERA AVX reserves the rights to supply higher voltage rating in the same case size, to the same reliability standards.

TWC SERIES

COTS-Plus – Conventional Wet Tantalum

STANDARD RATINGS & PART NUMBER REFERENCE

Part Number	Cap (µF) 25°C at 120Hz	DC Rated Voltage (V) at 85°C	DC Leakage (µA)		DF (Max)	ESR Max (Ohms) at 120Hz	Impedance max (Ohms) -55°C at 120Hz	Maximum Capacitance Change (%)			AC Ripple (mA rms) 85°C at 40kHz	Case Size	
			+25°C	+85°C & +125°C				-55°C	+85°C	+125°C		Standard	AVX
TWCA227*006□CSZ0^00	220	6	2	9	50	3.02	36	-64	13	16	1,000	T1	A
TWCA227*006□LSZ0^00					25	1.51							
TWCB827*006□CSZ0^00	820	6	3	14	155	2.51	18	-88	16	20	1,500	T2	B
TWCB827*006□LSZ0^00					77.5	1.26							
TWCD158*006□CSZ0^00	1,500	6	5	20	172	1.52	18	-90	20	25	1,900	T3	D
TWCD158*006□LSZ0^00					86	0.76							
TWCE228*006□CSZ0^00	2,200	6	6	24	170	1.03	13	-90	25	30	2,300	T4	E
TWCE228*006□LSZ0^00					85	0.52							
TWCA187*008□CSZ0^00	180	8	2	9	41	3.02	45	-60	13	16	1,000	T1	A
TWCA187*008□LSZ0^00					20.5	1.51							
TWCB687*008□CSZ0^00	680	8	3	14	130	2.54	22	-83	16	20	1,500	T2	B
TWCB687*008□LSZ0^00					65	1.27							
TWCD158*008□CSZ0^00	1,500	8	5	20	170	1.5	18	-90	20	25	1,900	T3	D
TWCD158*008□LSZ0^00					85	0.75							
TWCE188*008□CSZ0^00	1,800	8	7	25	138	1.02	14	-90	25	30	2,300	T4	E
TWCE188*008□LSZ0^00					69	0.51							
TWCA157*010□CSZ0^00	150	10	2	9	34	3.01	54	-55	13	16	900	T1	A
TWCA157*010□LSZ0^00					17	1.51							
TWCB567*010□CSZ0^00	560	10	3	16	106	2.51	27	-77	16	20	1,450	T2	B
TWCB567*010□LSZ0^00					53	1.26							
TWCD128*010□CSZ0^00	1,200	10	5	20	137	1.51	18	-88	20	25	1,850	T3	D
TWCD128*010□LSZ0^00					68.5	0.76							
TWCE158*010□CSZ0^00	1,500	10	7	25	114	1.01	15	-88	25	30	2,300	T4	E
TWCE158*010□LSZ0^00					57	0.51							
TWCA107*015□CSZ0^00	100	15	2	9	30	3.98	72	-44	13	16	900	T1	A
TWCA107*015□LSZ0^00					15	1.99							
TWCB397*015□CSZ0^00	390	15	3	16	74	2.52	31	-66	16	20	1,450	T2	B
TWCB397*015□LSZ0^00					37	1.26							
TWCD827*015□CSZ0^00	820	15	6	24	111	1.8	22	-77	20	25	1,800	T3	D
TWCD827*015□LSZ0^00					55.5	0.9							
TWCE108*015□CSZ0^00	1,000	15	8	32	92	1.22	17	-77	25	30	2,300	T4	E
TWCE108*015□LSZ0^00					46	0.61							
TWCA686*025□CSZ0^00	68	25	2	9	22	4.29	90	-40	12	15	850	T1	A
TWCA686*025□LSZ0^00					11	2.15							
TWCB277*025□CSZ0^00	270	25	3	16	55	2.7	33	-62	13	16	1,400	T2	B
TWCB277*025□LSZ0^00					27.5	1.35							
TWCD567*025□CSZ0^00	560	25	7	28	76	1.8	24	-72	20	25	1,750	T3	D
TWCD567*025□LSZ0^00					38	0.9							
TWCE687*025□CSZ0^00	680	25	8	32	63	1.23	19	-72	25	30	2,100	T4	E
TWCE687*025□LSZ0^00					31.5	0.62							
TWCA566*030□CSZ0^00	56	30	2	9	22	5.21	100	-38	12	15	800	T1	A
TWCA566*030□LSZ0^00					11	2.61							
TWCB227*030□CSZ0^00	220	30	3	16	42	2.53	36	-60	13	16	1,200	T2	B
TWCB227*030□LSZ0^00					21	1.27							
TWCD477*030□CSZ0^00	470	30	8	32	64	1.81	25	-65	20	25	1,500	T3	D
TWCD477*030□LSZ0^00					32	0.91							
TWCE567*030□CSZ0^00	560	30	9	36	55	1.3	20	-65	25	30	2,000	T4	E
TWCE567*030□LSZ0^00					27.5	0.65							
TWCA336*050□CSZ0^00	33	50	2	9	12.3	4.95	135	-29	10	12	700	T1	A
TWCA336*050□LSZ0^00					6.15	2.48							
TWCB127*050□CSZ0^00	120	50	4	24	22.5	2.49	49	-42	12	15	1,200	T2	B
TWCB127*050□LSZ0^00					11.3	1.25							
TWCD277*050□CSZ0^00	270	50	8	32	37	1.82	29	-46	20	25	1,450	T3	D
TWCD277*050□LSZ0^00					18.5	0.91							
TWCE337*050□CSZ0^00	330	50	9	36	38	1.53	22	-46	25	30	1,900	T4	E
TWCE337*050□LSZ0^00					19	0.77							
TWCA276*060□CSZ0^00	27	60	3	12	10.2	5.01	144	-24	10	12	700	T1	A
TWCA276*060□LSZ0^00					5.1	2.51							
TWCB107*060□CSZ0^00	100	60	4	20	19	2.52	54	-36	12	15	1,100	T2	B
TWCB107*060□LSZ0^00					9.5	1.26							
TWCD227*060□CSZ0^00	220	60	8	32	30	1.81	29	-40	16	20	1,400	T3	D
TWCD227*060□LSZ0^00					15	0.91							

All technical data relates to an ambient temperature of +25°C. Capacitance and DF are measured at 120Hz, 0.5RMS with DC bias of 2.2V. DCL is measured at rated voltage after 5 minutes.

NOTE: AVX reserves the rights to supply higher voltage rating in the same case size, to the same reliability standards.

TWC SERIES

COTS-Plus – Conventional Wet Tantalum

STANDARD RATINGS & PART NUMBER REFERENCE

Part Number	Cap (µF) 25°C at 120Hz	DC Rated Voltage (V) at 85°C	DC Leakage (µA)		DF (Max)	ESR Max (Ohms) at 120Hz	Impedance max (Ohms) -55°C at 120Hz	Maximum Capacitance Change (%)			AC Ripple (mA rms) 85°C at 40kHz	Case Size	
			+25°C	+85°C & +125°C				-55°C	+85°C	+125°C		Standard	AVX
TWCE277*060□CSZ0^00	270	60	9	36	27	1.33	23	-45	20	25	1,850	T4	E
TWCE277*060□LSZ0^00					13.5	0.67							
TWCA226*075□CSZ0^00	22	75	3	12	8.5	5.13	157	-19	10	12	600	T1	A
TWCA226*075□LSZ0^00					4.25	2.57							
TWCB826*075□CSZ0^00	82	75	4	24	15.2	2.46	63	-30	12	15	1,000	T2	B
TWCB826*075□LSZ0^00					7.6	1.23							
TWCD187*075□CSZ0^00	180	75	9	36	24.4	2.23	30	-35	16	20	1,300	T3	D
TWCD187*075□LSZ0^00					12.2	0.9							
TWCE227*075□CSZ0^00	220	75	10	40	37	1.8	24	-40	20	25	1,800	T4	E
TWCE227*075□LSZ0^00					18.5	1.12							
TWCA106*100□CSZ0^00	10	100	3	12	4.5	5.97	200	-17	10	12	800	T1	A
TWCA106*100□LSZ0^00					2.25	2.99							
TWCB396*100□CSZ0^00	39	100	5	24	10.4	3.54	80	-20	12	15	1,300	T2	B
TWCB396*100□LSZ0^00					5.2	1.77							
TWCD686*100□CSZ0^00	68	100	10	40	11.3	2.21	40	-30	14	16	1,600	T3	D
TWCD686*100□LSZ0^00					5.65	1.11							
TWCE127*100□CSZ0^00	120	100	12	48	25	2.76	30	-35	15	17	2,000	T4	E
TWCE127*100□LSZ0^00					12.5	1.38							
TWCB276*125□CSZ0^00	27	125	5	24	7.2	3.54	90	-18	12	15	1,200	T2	B
TWCB276*125□LSZ0^00					3.6	1.77							
TWCD476*125□CSZ0^00	47	125	10	40	7.9	2.23	50	-26	14	16	1,500	T3	D
TWCD476*125□LSZ0^00					3.95	1.12							
TWCE826*125□CSZ0^00	82	125	12	48	17.4	2.82	32	-30	15	17	1,900	T4	E
TWCE826*125□LSZ0^00					8.7	1.41							

All technical data relates to an ambient temperature of +25°C. Capacitance and DF are measured at 120Hz, 0.5RMS with DC bias of 2.2V. DCL is measured at rated voltage after 5 minutes.

NOTE: KYOCERA AVX reserves the rights to supply higher voltage rating in the same case size, to the same reliability standards.

TESTING

All TWC COTS-Plus product is tested using MIL-PRF-39006 test procedures.

Lot Conformance Testing*

Inspection	Sampling Procedure
Constant Voltage Conditioning DC Leakage Capacitance Dissipation Factor Seal, Condition A or D	100% Inspection
Visual Examination Material Marking Workmanship	13 Samples

*Additional testing and inspection is available, please contact the factory for details.

TWC-Y SERIES

High Temperature – COTS-Plus 200°C Wet Tantalum



The TWC-Y high temperature series represents a COTS-Plus version of conventional wet electrolytic tantalum capacitors that are designed for use at 200°C. The components listed are now capable of 500 hours of operation at extreme temperature with the applicable derated voltage.

This design includes a welded tantalum can and header assembly that provides a hermetic seal to withstand harsh environments.

This is a new product line so please contact the factory for availability and additional details.

CASE DIMENSIONS: millimeters (inches)

Standard Case Size	Case Size	L +0.79 (0.031) -0.41 (0.016)	D Basic Case ±0.41 (0.016)	D Insulated Case Max	E ±6.35 (0.250)
T1	A	11.51 (0.453)	4.78 (0.188)	5.56 (0.219)	38.10 (1.500)
T2	B	16.28 (0.641)	7.14 (0.281)	7.92 (0.312)	57.15 (2.250)
T3	D	19.46 (0.766)	9.52 (0.375)	10.31 (0.406)	57.15 (2.250)
T4	E	26.97 (1.062)	9.52 (0.375)	10.31 (0.406)	57.15 (2.250)

OUTLINE DIMENSIONS

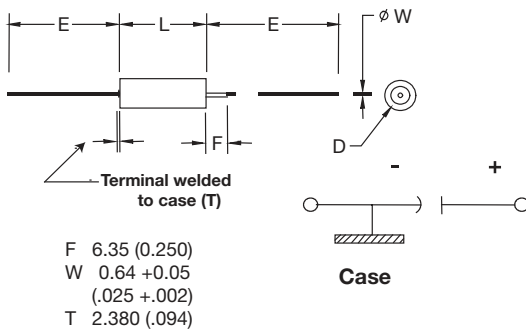

200°C LIFE TEST:

These components are capable of 500 hours of operation at 200°C with the applicable 60% derated voltage. Following the life test components which are stabilized at 25°C ± 5°C shall exhibit:

Leakage less than 200% the original requirement or ± 10µA (whichever is greater)

ESR not greater than 200% the original requirement

Capacitance increase less than 10% or decrease less than 20% the initial measurement

HOW TO ORDER

PART NUMBER:

TWC	B	476	*	050		C	Y	Z	^	00
Type	Case Size	Capacitance Code	Capacitance Tolerance	Voltage Code	Insulation Sleeve	ESR	Qualification	Reliability	Termination Finish	Custom Test Options
		pF code: 1st two digits represent significant figures 3rd digit represents multiplier (number of zeros to follow)	M = ±20% K = ±10%		C = Without Sleeve S = With Sleeve	C = Standard ESR	Y = High Temp.	Z = Non-ER	00 = Sn/Pb 60/40 07 = 100% Tin	00 = Standard



TECHNICAL SPECIFICATIONS

Technical Data: Unless otherwise specified, all technical data relate to an ambient temperature of +25°C

Capacitance Tolerance:	±10%; ±20%											
Rated Voltage (V _R)	≤ 85°C:	6	8	10	15	25	30	50	60	75	100	125
Category Voltage (V _C)	≤125°C:	4	5	7	10	15	20	30	40	50	65	85
High Temp. Voltage (V _T)	≤ 200°C:	3.6	4.8	6	9	12	18	30	36	45	60	75
Surge Voltage (V _S)	≤125°C:	6.9	9.2	11.5	17.3	28.8	34.5	57.5	69	86.3	115	144
Temperature Range:	-55°C to +200°C											

TWC-Y SERIES

High Temperature – COTS-Plus 200°C Wet Tantalum



STANDARD RATINGS & PART NUMBER REFERENCE

Part Number	Cap (µF) 25°C at 120Hz	DC Rated Voltage (V) at 85°C	DC Leakage (µA)		DF (max)	ESR Max (Ohms) at 120Hz	Maximum Capacitance Change (%)			Case Size	
			+25°C	+85°C & +125°C			-55°C	+85°C	+125°C	Standard	AVX
6 VDC at 85°C 4 VDC at 125°C 3.6 VDC at 200°C											
TWCB147*006□CYZ0*00	140	6	1	3	21	1.99	-40	14	16	T2	B
TWCD337*006□CYZ0*00	330	6	2	7.9	36	1.45	-44	14	16	T3	D
TWCD567*006□CYZ0*00	560	6	2	13	55	1.30	-64	17.5	20	T3	D
8 VDC at 85°C 5 VDC at 125°C 4.8 VDC at 200°C											
TWCB127*008□CYZ0*00	120	8	1	2	20	2.21	-44	17.5	20	T2	B
TWCD297*008□CYZ0*00	290	8	2	6	34	1.56	-64	17.5	20	T3	D
TWCD437*008□CYZ0*00	430	8	2	14	46	1.42	-64	17.5	20	T3	D
10 VDC at 85°C 7 VDC at 125°C 6 VDC at 200°C											
TWCB107*010□CYZ0*00	100	10	1	4	15	1.99	-36	14	16	T2	B
TWCD257*010□CYZ0*00	250	10	2	10	30	1.59	-40	14	16	T3	D
TWCD397*010□CYZ0*00	390	10	2	16	44	1.50	-64	17.5	20	T3	D
15 VDC at 85°C 10 VDC at 125°C 9 VDC at 200°C											
TWCB706*015□CYZ0*00	70	15	1	4	13	2.46	-28	14	16	T2	B
TWCD177*015□CYZ0*00	170	15	2	10	25	1.95	-32	14	16	T3	D
TWCD277*015□CYZ0*00	270	15	2	16	32	1.57	-56	17.6	20	T3	D
25 VDC at 85°C 15 VDC at 125°C 15 VDC at 200°C											
TWCA226*025□CYZ0*00	22	25	1	2	6.6	3.98	-20	10.5	12	T1	A
TWCA686*025□CYZ0*00	68	25	2	9	22	4.29	-50	12	15	T1	A
TWCB107*025□CYZ0*00	100	25	1	10	15	1.99	-28	13	15	T2	B
TWCD127*025□CYZ0*00	120	25	2	6	21	2.32	-32	13	15	T3	D
TWCD187*025□CYZ0*00	180	25	2	18	26	1.92	-48	13	15	T3	D
TWCB277*025□CYZ0*00	270	25	3	16	55	2.70	-62	13	16	T2	B
TWCD567*025□CYZ0*00	560	25	7	28	76	1.80	-77	20	25	T3	D
30 VDC at 85°C 20 VDC at 125°C 18 VDC at 200°C											
TWCA156*030□CYZ0*00	15	30	1	2	5	4.42	-20	10.5	12	T1	A
TWCA566*030□CYZ0*00	56	30	2	9	22	5.21	-48	12	15	T1	A
TWCB686*030□CYZ0*00	68	30	1	8	13	2.54	-24	13	15	T2	B
TWCD107*030□CYZ0*00	100	30	2	12	17	2.26	-28	10.5	12	T3	D
TWCD157*030□CYZ0*00	150	30	2	18	23	2.03	-48	13	15	T3	D
TWCB227*030□CYZ0*00	220	30	3	16	42	2.53	-60	13	16	T2	B
TWCE307*030□CYZ0*00	300	30	8	32	31	1.37	-60	25	25	T4	E
TWCD397*030□CYZ0*00	390	30	6	18	53	1.80	-65	18	25	T3	D
TWCD477*030□CYZ0*00	470	30	8	32	64	1.81	-70	20	25	T3	D
TWCE567*030□CYZ0*00	560	30	9	36	55	1.30	-65	25	30	T4	E
50 VDC at 85°C 30 VDC at 125°C 30 VDC at 200°C											
TWCA106*050□CYZ0*00	10	50	1	2	4	5.31	-24	8	9	T1	A
TWCA336*050□CYZ0*00	33	50	2	9	12.3	4.95	-39	10	12	T1	A
TWCB476*050□CYZ0*00	47	50	1	9	11	3.11	-28	13	15	T2	B
TWCD606*050□CYZ0*00	60	50	2	12	12	2.65	-16	10.5	12	T3	D
TWCD826*050□CYZ0*00	82	50	2	16	15	2.43	-32	13	15	T3	D
TWCB127*050□CYZ0*00	120	50	4	24	22.5	2.49	-42	12	15	T2	B
TWCE167*050□CYZ0*00	160	50	8	32	17	1.41	-50	25	25	T4	E
TWCD277*050□CYZ0*00	270	50	8	32	37	1.82	-51	20	25	T3	D
TWCE337*050□CYZ0*00	330	50	9	36	38	1.53	-46	25	30	T4	E
60V VDC at 85°C 40 VDC at 125°C 36 VDC at 200°C											
TWCA825*060□CYZ0*00	8.2	60	1	2	4	6.47	-24	8	9	T1	A
TWCA276*060□CYZ0*00	27	60	3	12	10.2	5.01	-34	10	12	T1	A
TWCD506*060□CYZ0*00	50	60	2	12	10	2.65	-16	10.5	12	T3	D
TWCD686*060□CYZ0*00	68	60	2	16	13	2.54	-32	10.5	12	T3	D
TWCB107*060□CYZ0*00	100	60	4	20	19	2.52	.36	12	15	T2	B
TWCE147*060□CYZ0*00	140	60	8	32	16	1.52	-40	20	20	T4	E
TWCD227*060□CYZ0*00	220	60	8	32	30	1.81	-45	16	20	T3	D
TWCE277*060□CYZ0*00	270	60	9	36	27	1.33	-45	20	25	T4	E
75V VDC at 85°C 50 VDC at 125°C 45 VDC at 200°C											
TWCA685*075□CYZ0*00	6.8	75	1	2	3.5	6.83	-20	8	9	T1	A
TWCA226*075□CYZ0*00	22	75	3	12	8.5	5.13	-29	10	12	T1	A
TWCD566*075□CYZ0*00	56	75	2	17	11	2.61	-28	10.5	15	T3	D
TWCB826*075□CYZ0*00	82	75	4	24	15.2	2.46	-30	12	15	T2	B
TWCE117*075□CYZ0*00	110	75	9	36	12	1.45	-35	20	20	T4	E
TWCD187*075□CYZ0*00	180	75	9	36	24.4	2.23	-40	16	20	T3	D
TWCE227*075□CYZ0*00	220	75	10	40	37	1.80	-40	20	25	T4	E
100 VDC at 85°C 65 VDC at 125°C 60 VDC at 200°C											
TWCB226*100□CYZ0*00	22	100	1	9	7.5	4.52	-16	8	8	T2	B
TWCE127*100□CYZ0*00	120	100	12	48	25	2.76	-35	15	17	T4	E
125 VDC at 85°C 85 VDC at 125°C 75 VDC at 200°C											
TWCB276*125□CYZ0*00	27	125	5	24	7.2	3.54	-18	12	15	T2	B
TWCE826*125□CYZ0*00	82	125	12	48	17.4	2.82	-30	15	17	T4	E

All technical data relates to an ambient temperature of +25°C. Capacitance and DF are measured at 120Hz, 0.5RMS with DC bias of 2.2V. DCL is measured at rated voltage after 5 minutes. Note: KYOCERA AVX reserves the right to supply higher voltage rating in the same case size to the same reliability standards.

144 The Important Information/Disclaimer is incorporated in the catalog where these specifications came from or available online at www.kyocera-avx.com/disclaimer/ by reference and should be reviewed in full before placing any order.

TWD HIGH TEMP MAX CAP SERIES

Wet Tantalum Super Capacitor



The TWD series is an axial leaded wet electrolytic tantalum capacitor designed for DC (hold-up) and low frequency pulse applications.

Utilizing high CV Tantalum powders the TWD series achieves extreme high capacitance values that are similar to the Super capacitor range. The TWD offers extended temperature range up to 175°C and extended life up to 10000 hrs.

Components are suitable for automatic mounting and soldering.

Well-established wet tantalum design is suitable for applications with hi-reliability requirements. Contact the factory about design possibilities beyond those contained in this datasheet.

FEATURES

- Super high capacitance
- -55 to 175°C operation temperature
- Hermetic packaging
- Endurance up to 10 000 hrs. on selected codes
- High electrical and mechanical stability

APPLICATIONS

- Special industrial
- Avionics
- Military
- Down hole drilling

OUTLINE DIMENSIONS

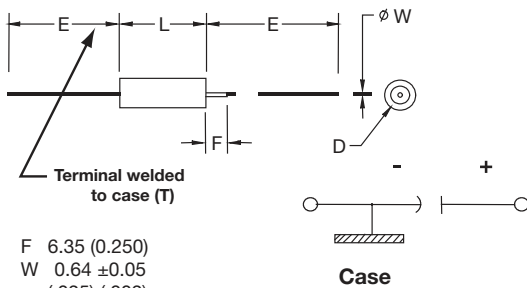

F 6.35 (0.250)
 W 0.64 ±0.05
 (.025) (.002)
 T 2.380 (.094)

CASE DIMENSIONS: millimeters (inches)

DLA Case Size	Case Size	L +0.79 (0.031) -0.41 (0.016)	D Without Insulating Sleeve ±0.41 (0.016)	D With Insulating Sleeve Max	E ±6.35 (0.250)
T4	E	26.97 (1.062)	9.52 (0.375)	10.31 (0.406)	57.15 (2.250)

CAPACITANCE AND RATED VOLTAGE, V_R (VOLTAGE CODE) RANGE (LETTER DENOTES CASE SIZE)

DC Capacitance		Rated Voltage DC (V _R) to 85°C		
mF	Code	3V	6.3V	10V
25	253			E
50	503		E	
100	104	E		

Available Ratings

TWD HIGH TEMP MAX CAP SERIES

Wet Tantalum Super Capacitor

HOW TO ORDER

PART NUMBER:

TWD	E	503	*	006	□	B	0	Z	0	^	00
Type	Case Size	Capacitance Code	Capacitance Tolerance	Voltage Code	Insulation Sleeve	Packaging	Inspection Level	Reliability	Qualification Level	Termination Finish	Custom Test Options
		µF code: 1st two digits represent significant figures 3rd digit represents multiplier (number of zeros to follow)	K = ±10% M = ±20%	003=3Vdc 006 = 6.3Vdc 010 = 10Vdc	C = Without Sleeve S = With Sleeve	B = Tray Pack	0 = N/A	Z = Non-ER	0 = N/A	0 = Sn/Pb 60/40 7 = Matte tin	00 = Standard



TECHNICAL SPECIFICATIONS

Technical Data:	All technical data relate to an ambient temperature of +25°C			
Capacitance Range:	25mF to 100mF (for extended range under development, contact manufacturer)			
Capacitance Tolerance:	±10%; ±20%			
Rated Voltage (V _R)	≤+105°C:	3	6.3	10
Category Voltage (V _C)	≤+125°C:	2	4.2	6.6
Category Voltage (V _C)	≤+150°C:	2	4.2	6.6
High Temperature Voltage (V _T)	≤+175°C:	1.5	3.15	5
Surge Voltage (V _S)	≤+105°C:	3.45	7.2	11.5
Temperature Range:	-55°C to +175°C			
Endurance:	10,000h at +105°C/V _R and 2000h at +175°C/V _T			
Reliability:	1% per 1000 hours at 85°C, VR with 0.1Ω/Vseries impedance, 60% confidence level			
Termination Finish:	Sn Plating, SnPb Plating 60/40			

RATINGS & PART NUMBER REFERENCE

Part Number	Cap (mF) ^{2/} at 25°C	Rated Voltage (V)	Rated Temperature (°C)	DC Leakage max (µA) ^{1/}			Maximum Capacitance Change (%)					ESR Max (mOhms) at 1kHz	Case Size		Lifetime at 105°C (hrs.)	Lifetime at 175°C (hrs.)	
				+25°C	+85°C & +105°C & +125°C	+150°C & +175°C	-55°C	+85°C	+125°C	+150°C	+175°C		KAVX	DLA			
3 VDC at 105°C																	
TWDE104*003□B0Z0*00	100	3	85	40	60	500	-25	38	55	65	80	500	E	T4	2,000	1000	
6.3 VDC at 105°C																	
TWDE503*006□B0Z0*00	50	6.3	85	20	60	600	-15	20	30	50	60	400	E	T4	10,000	2000	
10 VDC at 105°C																	
TWDE253*010□B0Z0*00	25	10	85	20	60	600	-15	20	30	35	40	400	E	T4	10,000	2000	

1/ DCL is measured at rated or category voltage after 20 minutes.

2/ DC capacitance is measured by discharging initially fully charged capacitor down to 0.37Ur through 1kOhm.



KYOCERA AVX modular packaged 93026 style capacitors.

Capacitance Range: 200 μ F to 9000 μ F
Voltage Range: 25 to 125V
Temperature Range: -55°C to 125°C
Tolerance Range: 10%, 20%

DIMENSIONS: millimeters (inches)

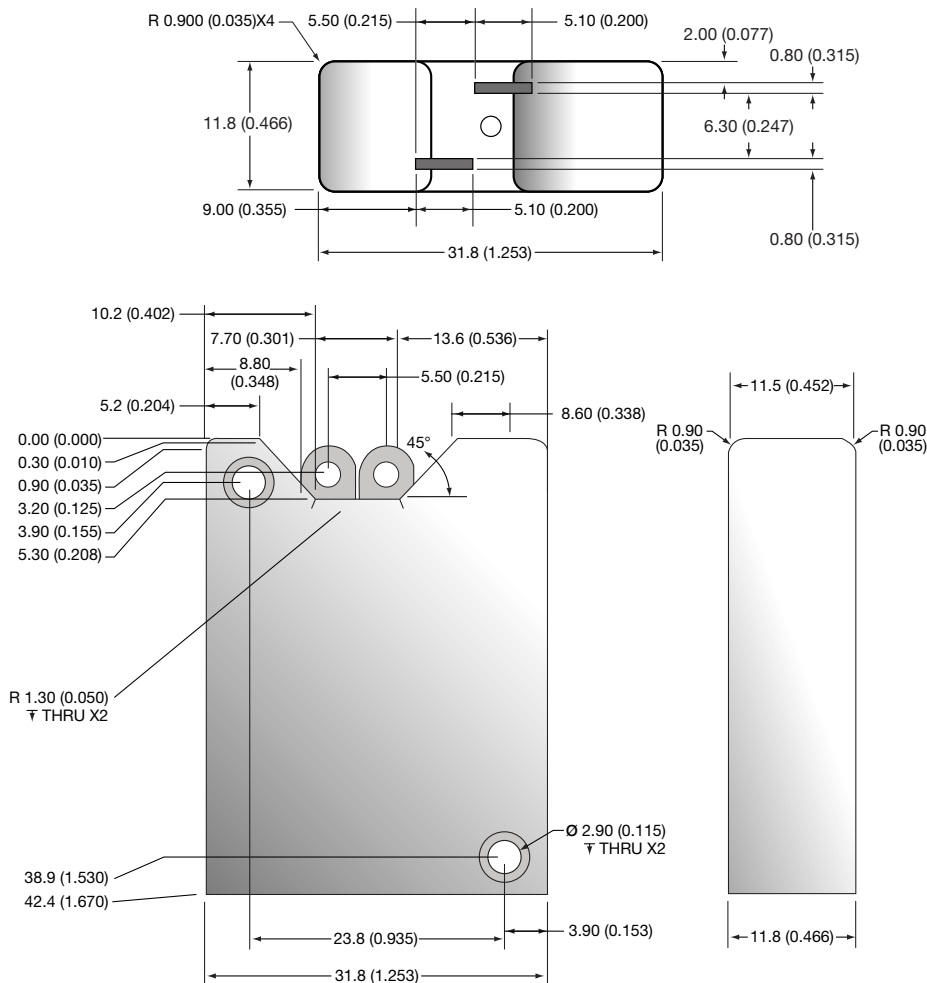

VOLTAGE RATINGS (Operating Temperature -55°C to 125°C)

Voltage (DC)								
Rated Voltage: (Ur)	85°C	25	30	50	60	75	100	125
Derated Voltage: (Uc)	125°C	15	20	30	40	50	65	85
Surge Voltage: (Us)	85°C	28.8	34.5	57.5	69	86.3	115	144

HOW TO ORDER

PART NUMBER:

TW	2E	227	*		C	B	@	Z	0	S	++
↓	↓	↓	↓	↓	↓	↓	↓	↓	↓	↓	↓
Type	Style	Capacitance Code	Capacitance Tolerance	Voltage	C = N/A	Packaging	Qualification	Established Reliability	Reliability Grade	Termination Finish	Special Code
		pF code: 1st two digits represent significant figures 3rd digit represents multiplier (number of zeros to follow)	K = ±10% M = ±20%			B = Bulk	S = COTS-PLUS	Z = Non-ER	0 = Standard	S = Silver Plating	00 = Standard

Not RoHS Compliant

SnPb termination option is not RoHS compliant.

RIPPLE CURRENT MULTIPLIERS vs. Frequency, temperature and applied voltage^{1/2/}

Frequency of Applied Ripple Current	120Hz				800Hz				1kHz				
	≤55	85	105	125	≤55	85	105	125	≤55	85	105	125	
% of 85°C Rated Peak Voltage	100%	0.60	0.39	–	–	0.71	0.43	–	–	0.72	0.45	–	–
90%	0.60	0.46	–	–	0.71	0.55	–	–	0.72	0.55	–	–	
80%	0.60	0.52	0.35	–	0.71	0.62	0.42	–	0.72	0.62	0.42	–	
70%	0.60	0.58	0.44	–	0.71	0.69	0.52	–	0.72	0.70	0.52	–	
66-2/3%	0.60	0.60	0.46	0.27	0.71	0.71	0.55	0.32	0.72	0.72	0.55	0.32	

Frequency of Applied Ripple Current	10kHz				40kHz				100kHz			
	≤55	85	105	125	≤55	85	105	125	≤55	85	105	125
% of 85°C Rated Peak Voltage												

1/At 125°C the rated voltage of the capacitors decreases to 66 2/3 of the 85°C rated voltage.
2/The peak of the applied ac ripple voltage plus the applied dc voltage must not exceed the dc voltage rating of the capacitors.

RATINGS & PART NUMBER REFERENCE

Part Number	Cap (µF) 25°C at 120Hz	DC Rated Voltage (V) 85°C	ESR Max (ohms) 120Hz	DC Leakage Max (µA)1/		Max Impedance (Ohms) -55°C at 120 Hz	Maximum Capacitance Change (%)			AC Ripple* (mA rms) 85°C at 40kHz
				+25°C	+85 and +125°C		-55°C	+85°C	+125°C	
25 VDC at 85°C 15 VDC at 125°C										
TW2D248*025CB@Z0S++	2400	25	0.33	10	40	3.50	-70	12	18	5200
TW3D368*025CB@Z0S++	3600	25	0.22	15	60	2.33	-70	12	18	7800
TW2E368*025CB@Z0S++	3600	25	0.25	12	50	3.50	-75	12	20	6200
TW2E448*025CB@Z0S++	4400	25	0.25	20	160	5.00	-90	30	50	6400
TW3E548*025CB@Z0S++	5400	25	0.17	18	75	2.33	-75	12	20	9300
TW3E668*025CB@Z0S++	6600	25	0.17	30	240	3.33	-90	30	50	9600
30 VDC at 85°C 20 VDC at 125°C										
TW2D208*030CB@Z0S++	2000	30	0.35	14	50	3.50	-70	10	18	5000
TW3D308*030CB@Z0S++	3000	30	0.23	21	75	2.33	-70	10	18	7500
TW2E308*030CB@Z0S++	3000	30	0.30	24	70	3.00	-72	10	20	6000
TW3E458*030CB@Z0S++	4500	30	0.20	36	105	2.00	-72	10	20	9000
50 VDC at 85°C 30 VDC at 125°C										
TW2D947*050CB@Z0S++	940	50	0.38	6	50	5.00	-50	8	15	4200
TW2E148*050CB@Z0S++	1360	50	0.35	10	80	4.00	-58	10	20	5500
TW3D148*050CB@Z0S++	1410	50	0.25	9	75	3.33	-50	8	15	6300
TW3E208*050CB@Z0S++	2040	50	0.23	15	120	2.67	-58	10	20	8250
TW2E308*050CB@Z0S++	3000	50	0.50	38	200	7.50	-90	25	35	6000
TW3E458*050CB@Z0S++	4500	50	0.33	57	300	5.00	-90	25	35	9000
TW3E908*050CB@Z0S++	9000	50	0.33	150	450	1.20	-80	60	85	9300
60 VDC at 85°C 40 VDC at 125°C										
TW2D787*060CB@Z0S++	780	60	0.45	6	50	7.50	-60	8	15	4200
TW2E118*060CB@Z0S++	1120	60	0.40	10	80	5.00	-58	8	15	5500
TW3D128*060CB@Z0S++	1170	60	0.30	9	75	5.00	-60	8	15	6300
TW3E178*060CB@Z0S++	1680	60	0.27	15	120	3.33	-58	8	15	8250
TW2E208*060CB@Z0S++	2000	60	0.50	24	180	10.00	-90	30	50	6400
TW3E308*060CB@Z0S++	3000	60	0.33	36	270	6.67	-90	30	50	9600
75 VDC at 85°C 50 VDC at 125°C										
TW2D667*075CB@Z0S++	660	75	0.50	6	60	6.00	-45	6	10	4200
TW2E947*075CB@Z0S++	940	75	0.45	10	100	6.00	-55	6	10	5500
TW3D997*075CB@Z0S++	990	75	0.33	9	90	4.00	-45	6	10	6300
TW3E148*075CB@Z0S++	1410	75	0.30	15	150	4.00	-55	6	10	8250
100 VDC at 85°C 65 VDC at 125°C										
TW2D307*100CB@Z0S++	300	100	0.80	6	50	11.00	-35	6	12	4200
TW2E447*100CB@Z0S++	440	100	0.60	10	100	7.50	-40	6	12	5500
TW3D457*100CB@Z0S++	450	100	0.53	9	75	7.33	-35	6	12	6300
TW3E667*100CB@Z0S++	660	100	0.40	15	150	5.00	-40	6	12	8250
125 VDC at 85°C 85 VDC at 125°C										
TW2D207*125CB@Z0S++	200	125	0.90	6	50	17.50	-35	5	12	4200
TW3D307*125CB@Z0S++	300	125	0.60	9	75	11.67	-35	5	12	6300
TW2E307*125CB@Z0S++	300	125	0.80	10	100	10.00	-35	6	12	5500
TW3E457*125CB@Z0S++	450	125	0.53	15	150	6.67	-35	6	12	8250
TW3E997*125CB@Z0S++	990	125	0.33	45	450	6.66	-60	20	60	7500

*For reference only, contact factory for more details

TWM-Y MODULE

UNDER DEVELOPMENT



The new High Temperature version TWM-Y of successful TWM range would expand operation capability in to higher temperature (+200°C) offering high capacitance and voltage for special demanded designs.
The parts would meet COTS-Plus reliability level.

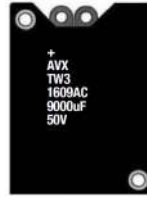

KYOCERA AVX modular packaged 93026 style capacitors.

Temperature Range: -55°C to 200°C
Tolerance Range: 10%, 20%

DIMENSIONS: millimeters (inches)

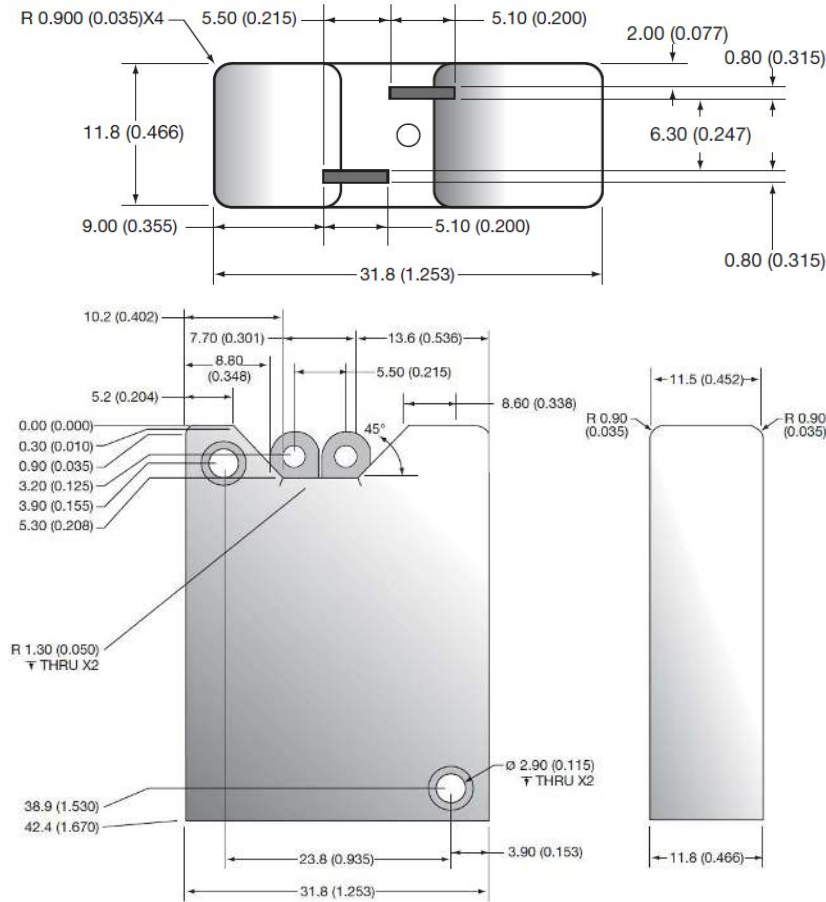

VOLTAGE RATINGS (Operating Temperature -55°C to 200°C)

Temp. Voltage	Voltage (DC) for 3E 9000/50	Voltage (DC) for 3E 990/125
Rated @ 85°C	50	125
Category @ 125°C	30	85
Surge @ 85°C	57.5	144
Category @ 150°C	33	80
Category @ 175°C	25	75
Category @ 200°C	12	65

TWM-Y MODULE

UNDER DEVELOPMENT



HOW TO ORDER

PART NUMBER:

TW	3E	908	*	050	C	B	Y	Z	0	S	00
↓	↓	↓	↓	↓	↓	↓	↓	↓	↓	↓	↓
Type	Style	Capacitance Code pF code: 1st two digits represent significant figures 3rd digit represents multiplier (number of zeros to follow)	Capacitance Tolerance K = ±10% M = ±20%	Voltage Code	C = N/A	Packaging B = Bulk	Qualification Y = High Temp	Reliability Z = Non-ER	Qualification Level 0 = Standard	Termination Finish S = Silver Plating	Special Code 00 = Standard

SnPb termination option is not RoHS compliant.

Not RoHS Compliant

RATINGS & PART NUMBER REFERENCE

Part Number	Cap (µF) 25°C at 120Hz	DC Rated Voltage (V) at 85°C	ESR Max (ohms) at 120Hz	DC Leakage Max (µA)				Impedance max (Ohms) -55°C at 120 Hz	Maximum Capacitance Change* (%)					AC Ripple* (mA rms) 85°C at 40kHz	Lifetime at 175°C (hrs.)			
				+25°C	+85 & +125°C	+150°C	+175°C		-55°C	+85°C	+125°C	+150°C	+175°C					
				50 VDC at 85°C 30 VDC at 125°C														
TW3E908*050CB@Z0S00	9000	50	0.33	150	450	600	800	1.20	-80	40	50	60	70	9300	500			
				125 VDC at 85°C 85 VDC at 125°C														
TW3E997*125CB@Z0S00	990	125	0.27	70	400	400	400	3.33	-45	15	25	TBD	TBD	10800	500			

Engineering samples - please contact KYOCERA AVX

*For reference only, contact factory for more details

TAJ ESCC TANTALUM CAPACITORS

SMD Solid Tantalum Chip Capacitors

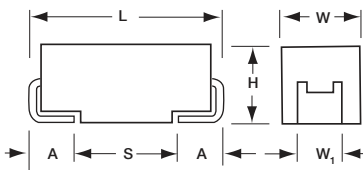
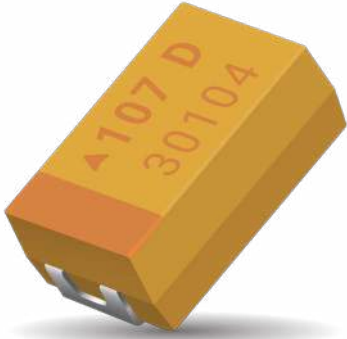

GENERAL DESCRIPTION

Capacitors, Fixed, Leadless Surface Mount, Chip, Solid electrolyte Tantalum for use in ESCC space programs, according to ESCC Generic Specification 3012 and associated Detail Specification 3012/001 as recommended by the Space Components Coordination Group (ranges in table below).



CASE DIMENSIONS: millimeters (inches)

Code	EIA Code	Variant	L±0.20 (0.008)	W+0.20 (0.008) -0.10 (0.004)	H+0.20 (0.008) -0.10 (0.004)	W ₁ ±0.20 (0.008)	A+0.30 (0.012) -0.20 (0.008)	S Min.
A	3216-18	01	3.20 (0.126)	1.60 (0.063)	1.60 (0.063)	1.20 (0.047)	0.80 (0.031)	1.10 (0.043)
B	3528-21	02	3.50 (0.138)	2.80 (0.110)	1.90 (0.075)	2.20 (0.087)	0.80 (0.031)	1.40 (0.055)
C	6032-28	13	6.00 (0.236)	3.20 (0.126)	2.60 (0.102)	2.20 (0.087)	1.30 (0.051)	2.90 (0.114)
D	7343-31	14	7.30 (0.287)	4.30 (0.169)	2.90 (0.114)	2.40 (0.094)	1.30 (0.051)	4.40 (0.173)
E	7343-43	17	7.30 (0.287)	4.30 (0.169)	4.10 (0.162)	2.40 (0.094)	1.30 (0.051)	4.40 (0.173)

W₁ dimension applies to the termination width for A dimensional area only.

MARKING

A, B, C, D, E CASE

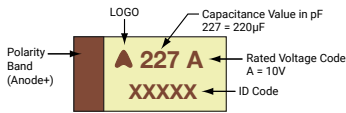

ESCC DETAIL SPECIFICATION No. 3012/001 Issue 6 -Reference for open orders only

HOW TO ORDER – PART NUMBER:

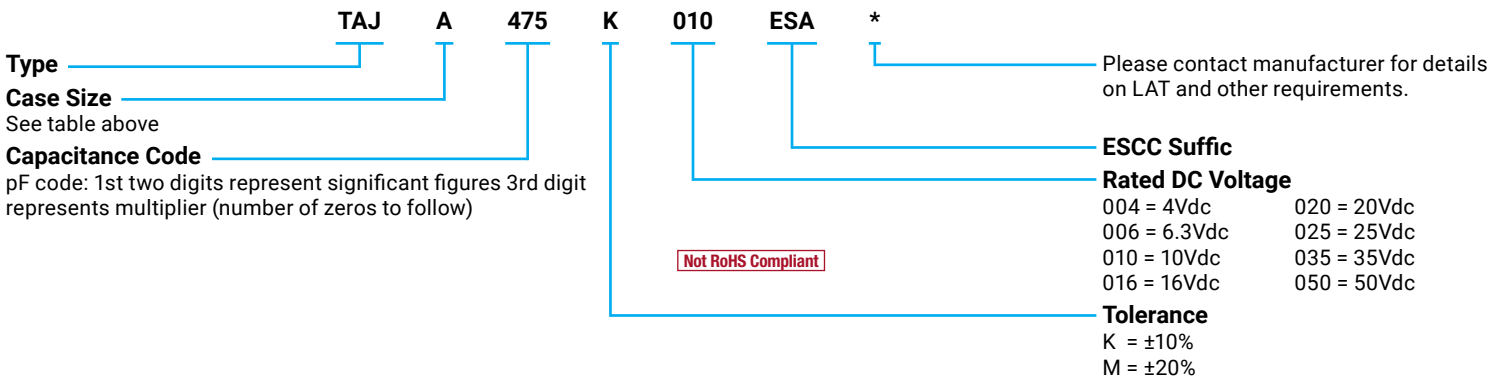

ESCC PART NUMBER – MANDATORY FOR ORDERING:

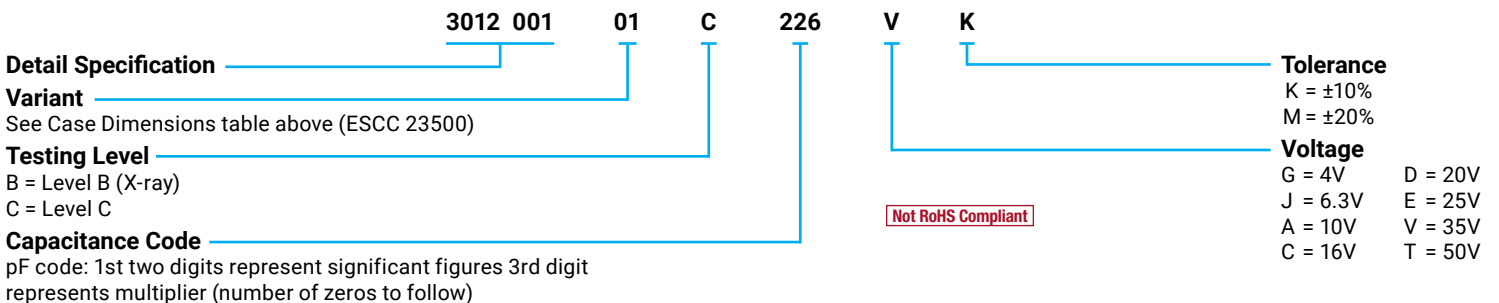

TAJ ESCC TANTALUM CAPACITORS

SMD Solid Tantalum Chip Capacitors

ESCC DETAIL SPECIFICATION No. 3012/001 Issue 9

HOW TO ORDER PART NUMBER:

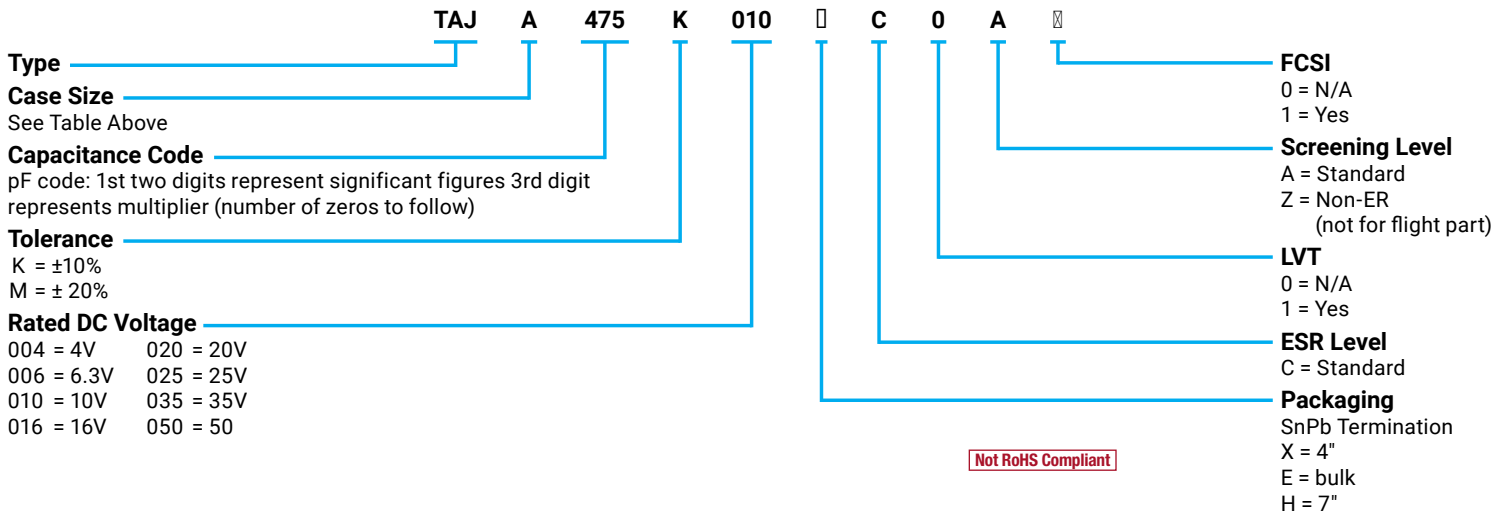

ESCC PART NUMBER – MANDATORY FOR ORDERING:

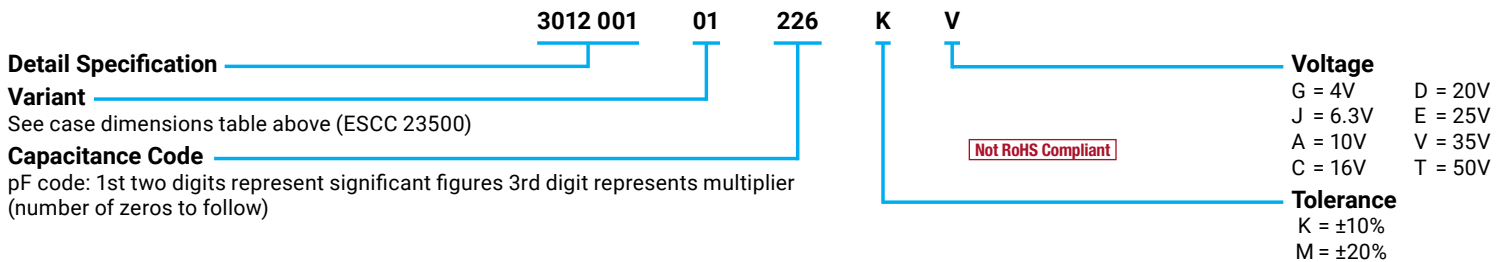

CAPACITANCE AND RATED VOLTAGE, V_R (VOLTAGE CODE) RANGE (LETTER DENOTES CASE SIZE)

Capacitance		Rated Voltage DC (V _R) at 85°C							
μF	Code	4V (G)	6.3V (J)	10V (A)	16V (C)	20V (D)	25V (E)	35V (V)	50V (T)
0.10	104							A	A
0.15	154							A	B
0.22	224							A	B
0.33	334							A	B
0.47	474						A	A/B	C
0.68	684					A	A	A/B	C
1.0	105				A	A	A	B	C
1.5	155			A	A	A	B	B/C	D
2.2	225		A	A	A/B	B	B	B/C	D
3.3	335	A	A	A	A/B	B	B/C	C	D
4.7	475	A	A	A/B	B	B/C	C	C/D	D
6.8	685	A	A/B	B	B/C	C	C/D	D	D
10	106	A/B	B	B/C	C	C	C/D	D	E
15	156	B	B/C	C	C	C/D	D	D	
22	226	B/C	C	C	C/D	D	D	E	
33	336	C	C	C/D	D	D	E		
47	476	C/D	C/D	C/D	D	E			
68	686	C/D	D	D	D	E			
100	107	D	D	D	E				
150	157	D	D	E					
220	227	E	E	E					

OPTION

Packaging: Tape and reel available on request – Contact marketing.

TAJ ESCC TANTALUM CAPACITORS

SMD Solid Tantalum Chip Capacitors



RATINGS & PART NUMBER REFERENCE, Issue 6 -Reference for open orders only

ESCC Part No.	Part No.	Case Size	Capacitance (µF)	Rated Voltage (V)	DCL Max. (µA)	DF Max. (%)	ESR Max. @100kHz (Ω)	100kHz Ripple Current (mA) Ratings			100kHz Ripple Voltage (mV) Ratings		
								25°C	85°C	125°C	25°C	85°C	125°C
4 Volt @ 85°C (2.7 Volt @ 125°C)													
301200101#335G*	TAJA335*004ESA	A	3.3	4	0.5	6	9	91	82	37	822	739	329
301200101#475G*	TAJA475*004ESA	A	4.7	4	0.5	6	7.5	100	90	40	750	675	300
301200101#685G*	TAJA685*004ESA	A	6.8	4	0.5	6	6.5	107	97	43	698	628	279
301200101#106G*	TAJA106*004ESA	A	10	4	0.5	6	6	112	101	45	671	604	268
301200102#106G*	TAJB106*004ESA	B	10	4	0.5	6	4	146	131	58	583	525	233
301200102#156G*	TAJB156*004ESA	B	15	4	0.6	6	3	168	151	67	505	454	202
301200102#226G*	TAJB226*004ESA	B	22	4	0.9	6	2.5	184	166	74	461	415	184
301200113#226G*	TAJC226*004ESA	C	22	4	0.9	6	2.3	219	197	87	503	453	201
301200113#336G*	TAJC336*004ESA	C	33	4	1.3	6	2	235	211	94	469	422	188
301200113#476G*	TAJC476*004ESA	C	47	4	1.9	6	1.8	247	222	99	445	400	178
301200114#476G*	TAJD476*004ESA	D	47	4	1.9	6	1.8	289	260	115	520	468	208
301200113#686G*	TAJC686*004ESA	C	68	4	2.7	6	1.6	262	236	105	420	378	168
301200114#686G*	TAJD686*004ESA	D	68	4	2.7	6	1.1	369	332	148	406	366	162
301200114#107G*	TAJD107*004ESA	D	100	4	4	6	0.9	408	367	163	367	331	147
301200114#157G*	TAJD157*004ESA	D	150	4	6	6	0.9	408	367	163	367	331	147
301200117#227G*	TAJE227*004ESA	E	220	4	8.8	6	0.9	428	385	171	385	347	154
6.3 Volt @ 85°C (4 Volt @ 125°C)													
301200101#225J*	TAJA225*006ESA	A	2.2	6.3	0.5	6	9	91	82	37	822	739	329
301200101#335J*	TAJA335*006ESA	A	3.3	6.3	0.5	6	7	104	93	41	725	652	290
301200101#475J*	TAJA475*006ESA	A	4.7	6.3	0.5	6	6	112	101	45	671	604	268
301200101#685J*	TAJA685*006ESA	A	6.8	6.3	0.5	6	5	122	110	49	612	551	245
301200102#685J*	TAJB685*006ESA	B	6.8	6.3	0.5	6	4	146	131	58	583	525	233
301200102#106J*	TAJB106*006ESA	B	10	6.3	0.6	6	3	168	151	67	505	454	202
301200102#156J*	TAJB156*006ESA	B	15	6.3	0.9	6	2	206	186	82	412	371	165
301200113#156J*	TAJC156*006ESA	C	15	6.3	0.9	6	2.5	210	189	84	524	472	210
301200113#226J*	TAJC226*006ESA	C	22	6.3	1.4	6	2	235	211	94	469	422	188
301200113#336J*	TAJC336*006ESA	C	33	6.3	2.1	6	1.8	247	222	99	445	400	178
301200113#476J*	TAJC476*006ESA	C	47	6.3	3	6	1.6	262	236	105	420	378	168
301200114#476J*	TAJD476*006ESA	D	47	6.3	3	6	1.1	369	332	148	406	366	162
301200114#686J*	TAJD686*006ESA	D	68	6.3	4.3	6	0.9	408	367	163	367	331	147
301200114#107J*	TAJD107*006ESA	D	100	6.3	6.3	6	0.9	408	367	163	367	331	147
301200114#157J*	TAJD157*006ESA	D	150	6.3	9.5	6	0.9	408	367	163	367	331	147
301200117#227J*	TAJE227*006ESA	E	220	6.3	13.9	6	0.4	642	578	257	257	231	103
10 Volt @ 85°C (7 Volt @ 125°C)													
301200101#155A*	TAJA155*010ESA	A	1.5	10	0.5	6	10	87	78	35	866	779	346
301200101#225A*	TAJA225*010ESA	A	2.2	10	0.5	6	7	104	93	41	725	652	290
301200101#335A*	TAJA335*010ESA	A	3.3	10	0.5	6	5.5	117	105	47	642	578	257
301200101#475A*	TAJA475*010ESA	A	4.7	10	0.5	6	5	122	110	49	612	551	245
301200102#475A*	TAJB475*010ESA	B	4.7	10	0.5	6	4	146	131	58	583	525	233
301200102#685A*	TAJB685*010ESA	B	6.8	10	0.7	6	3	168	151	67	505	454	202
301200102#106A*	TAJB106*010ESA	B	10	10	1	6	2.1	201	181	80	422	380	169
301200113#106A*	TAJC106*010ESA	C	10	10	1	6	2.5	210	189	84	524	472	210
301200113#156A*	TAJC156*010ESA	C	15	10	1.5	6	2	235	211	94	469	422	188
301200113#226A*	TAJC226*010ESA	C	22	10	2.2	6	1.8	247	222	99	445	400	178
301200113#336A*	TAJC336*010ESA	C	33	10	3.3	6	1.6	262	236	105	420	378	168
301200114#336A*	TAJD336*010ESA	D	33	10	3.3	6	1.1	369	332	148	406	366	162
301200113#476A*	TAJC476*010ESA	C	47	10	4.7	6	1.2	303	272	121	363	327	145
301200114#476A*	TAJD476*010ESA	D	47	10	4.7	6	0.4	612	551	245	245	220	98
301200114#686A*	TAJD686*010ESA	D	68	10	6.8	6	0.9	408	367	163	367	331	147
301200114#107A*	TAJD107*010ESA	D	100	10	10	6	0.9	408	367	163	367	331	147
301200117#157A*	TAJE157*010ESA	E	150	10	15	6	0.9	428	385	171	385	347	154
301200117#227A*	TAJE227*010ESA	E	220	10	22	6	0.5	574	517	230	287	259	115
16 Volt @ 85°C (10 Volt @ 125°C)													
301200101#105C*	TAJA105*016ESA	A	1.0	16	0.5	4	11	83	74	33	908	817	363
301200101#155C*	TAJA155*016ESA	A	1.5	16	0.5	6	8	97	87	39	775	697	310
301200101#225C*	TAJA225*016ESA	A	2.2	16	0.5	6	6.5	107	97	43	698	628	279
301200102#225C*	TAJB225*016ESA	B	2.2	16	0.5	6	5.5	124	112	50	684	615	273
301200101#335C*	TAJA335*016ESA	A	3.3	16	0.5	6	5	122	110	49	612	551	245
301200102#335C*	TAJB335*016ESA	B	3.3	16	0.5	6	4.5	137	124	55	618	557	247
301200102#475C*	TAJB475*016ESA	B	4.7	16	0.8	6	3.5	156	140	62	545	491	218
301200102#685C*	TAJB685*016ESA	B	6.8	16	1.1	6	2.5	184	166	74	461	415	184
301200113#685C*	TAJC685*016ESA	C	6.8	16	1.1	6	2.5	210	189	84	524	472	210
301200113#106C*	TAJC106*016ESA	C	10	16	1.6	6	2	235	211	94	469	422	188
301200113#156C*	TAJC156*016ESA	C	15	16	2.4	6	1.8	247	222	99	445	400	178

All technical data relates to an ambient temperature of +25°C. Capacitance and DF are measured at 120Hz, 0.5V RMS with a maximum DC bias of 2.2 volts. DCL is measured at rated voltage after 5 minutes. NOTE: KYOCERA AVX reserves the right to supply a higher voltage rating or tighter tolerance part in the same case size, to the same reliability standards.

TAJ ESCC TANTALUM CAPACITORS

SMD Solid Tantalum Chip Capacitors



RATINGS & PART NUMBER REFERENCE, Issue 6 -Reference for open orders only

ESCC Part No.	Part No.	Case Size	Capacitance (µF)	Rated Voltage (V)	DCL Max. (µA)	DF Max. (%)	ESR Max. @100kHz (Ω)	100kHz Ripple Current (mA) Ratings			100kHz Ripple Voltage (mV) Ratings		
								25°C	85°C	125°C	25°C	85°C	125°C
								301200113#226C*	TAJC226*016ESA	C	22	16	3.5
301200114#226C*	TAJD226*016ESA	D	22	16	3.5	6	1.1	369	332	148	406	366	162
301200114#336C*	TAJD336*016ESA	D	33	16	5.3	6	0.9	408	367	163	367	331	147
301200114#476C*	TAJD476*016ESA	D	47	16	7.5	6	0.9	408	367	163	367	331	147
301200114#686C*	TAJD686*016ESA	D	68	16	10.9	6	0.9	408	367	163	367	331	147
301200117#107C*	TAJE107*016ESA	E	100	16	16	6	0.9	428	385	171	385	347	154
20 Volt @ 85°C (13 Volt @ 125°C)													
301200101#684D*	TAJA684*020ESA	A	0.68	20	0.5	4	12	79	71	32	949	854	379
301200101#105D*	TAJA105*020ESA	A	1.0	20	0.5	4	9	91	82	37	822	739	329
301200101#155D*	TAJA155*020ESA	A	1.5	20	0.5	6	6.5	107	97	43	698	628	279
301200102#225D*	TAJB225*020ESA	B	2.2	20	0.5	6	3.5	156	140	62	545	491	218
301200102#335D*	TAJB335*020ESA	B	3.3	20	0.7	6	3	168	151	67	505	454	202
301200102#475D*	TAJB475*020ESA	B	4.7	20	0.9	6	3	168	151	67	505	454	202
301200113#475D*	TAJC475*020ESA	C	4.7	20	0.9	6	2.8	198	178	79	555	499	222
301200113#685D*	TAJC685*020ESA	C	6.8	20	1.4	6	2	235	211	94	469	422	188
301200113#106D*	TAJC106*020ESA	C	10	20	2	6	1.2	303	272	121	363	327	145
301200113#156D*	TAJC156*020ESA	C	15	20	3	6	1.7	254	229	102	432	389	173
301200114#156D*	TAJD156*020ESA	D	15	20	3	6	1.1	369	332	148	406	366	162
301200114#226D*	TAJD226*020ESA	D	22	20	4.4	6	0.9	408	367	163	367	331	147
301200114#336D*	TAJD336*020ESA	D	33	20	6.6	6	0.9	408	367	163	367	331	147
301200117#476D*	TAJE476*020ESA	E	47	20	9.4	6	0.9	428	385	171	385	347	154
301200117#686D*	TAJE686*020ESA	E	68	20	13.6	6	0.9	428	385	171	385	347	154
25 Volt @ 85°C (17 Volt @ 125°C)													
301200101#474E*	TAJA474*025ESA	A	0.47	25	0.5	4	14	73	66	29	1025	922	410
301200101#684E*	TAJA684*025ESA	A	0.68	25	0.5	4	10	87	78	35	866	779	346
301200101#105E*	TAJA105*025ESA	A	1.0	25	0.5	4	8	97	87	39	775	697	310
301200102#155E*	TAJB155*025ESA	B	1.5	25	0.5	6	5	130	117	52	652	587	261
301200102#225E*	TAJB225*025ESA	B	2.2	25	0.6	6	4.5	137	124	55	618	557	247
301200102#335E*	TAJB335*025ESA	B	3.3	25	0.8	6	3.5	156	140	62	545	491	218
301200113#335E*	TAJC335*025ESA	C	3.3	25	0.8	6	2.8	198	178	79	555	499	222
301200113#475E*	TAJC475*025ESA	C	4.7	25	1.2	6	2.4	214	193	86	514	462	206
301200113#685E*	TAJC685*025ESA	C	6.8	25	1.7	6	2	235	211	94	469	422	188
301200114#685E*	TAJD685*025ESA	D	6.8	25	1.7	6	1.4	327	295	131	458	412	183
301200113#106E*	TAJC106*025ESA	C	10	25	2.5	6	1.8	247	222	99	445	400	178
301200114#106E*	TAJD106*025ESA	D	10	25	2.5	6	1.2	354	318	141	424	382	170
301200114#156E*	TAJD156*025ESA	D	15	25	3.8	6	1	387	349	155	387	349	155
301200114#226E*	TAJD226*025ESA	D	22	25	5.5	6	0.9	408	367	163	367	331	147
301200117#336E*	TAJE336*025ESA	E	33	25	8.3	6	0.9	428	385	171	385	347	154
35 Volt @ 85°C (23 Volt @ 125°C)													
301200101#104V*	TAJA104*035ESA	A	0.10	35	0.5	4	24	56	50	22	1342	1207	537
301200101#154V*	TAJA154*035ESA	A	0.15	35	0.5	4	21	60	54	24	1255	1129	502
301200101#224V*	TAJA224*035ESA	A	0.22	35	0.5	4	18	65	58	26	1162	1046	465
301200101#334V*	TAJA334*035ESA	A	0.33	35	0.5	4	15	71	64	28	1061	955	424
301200101#474V*	TAJA474*035ESA	A	0.47	35	0.5	4	12	79	71	32	949	854	379
301200102#474V*	TAJB474*035ESA	B	0.47	35	0.5	4	10	92	83	37	922	830	369
301200101#684V*	TAJA684*035ESA	A	0.68	35	0.5	4	8	97	87	39	775	697	310
301200102#684V*	TAJB684*035ESA	B	0.68	35	0.5	4	8	103	93	41	825	742	330
301200102#105V*	TAJB105*035ESA	B	1.0	35	0.5	4	6.5	114	103	46	743	669	297
301200102#155V*	TAJB155*035ESA	B	1.5	35	0.5	6	5.2	128	115	51	665	598	266
301200113#155V*	TAJC155*035ESA	C	1.5	35	0.5	6	4.5	156	141	63	704	633	281
301200102#225V*	TAJB225*035ESA	B	2.2	35	0.8	6	4.2	142	128	57	597	538	239
301200113#225V*	TAJC225*035ESA	C	2.2	35	0.8	6	3.5	177	160	71	620	558	248
301200113#335V*	TAJC335*035ESA	C	3.3	35	1.2	6	2.5	210	189	84	524	472	210
301200113#475V*	TAJC475*035ESA	C	4.7	35	1.6	6	2.2	224	201	89	492	443	197
301200114#475V*	TAJD475*035ESA	D	4.7	35	1.6	6	1.5	316	285	126	474	427	190
301200114#685V*	TAJD685*035ESA	D	6.8	35	2.4	6	1.3	340	306	136	442	397	177
301200114#106V*	TAJD106*035ESA	D	10	35	3.5	6	1	387	349	155	387	349	155
301200114#156V*	TAJD156*035ESA	D	15	35	5.3	6	0.9	408	367	163	367	331	147
301200117#226V*	TAJE226*035ESA	E	22	35	7.7	6	0.5	574	517	230	287	259	115

All technical data relates to an ambient temperature of +25°C. Capacitance and DF are measured at 120Hz, 0.5V RMS with a maximum DC bias of 2.2 volts. DCL is measured at rated voltage after 5 minutes. NOTE: KYOCERA AVX reserves the right to supply a higher voltage rating or tighter tolerance part in the same case size, to the same reliability standards.

TAJ ESCC TANTALUM CAPACITORS

SMD Solid Tantalum Chip Capacitors



RATINGS & PART NUMBER REFERENCE, Issue 6 -Reference for open orders only

ESCC Part No.	Part No.	Case Size	Capacitance (μF)	Rated Voltage (V)	DCL Max. (μA)	DF Max. (%)	ESR Max. @100kHz (Ω)	100kHz Ripple Current (mA) Ratings			100kHz Ripple Voltage (mV) Ratings		
								25°C	85°C	125°C	25°C	85°C	125°C
50 Volt @ 85°C (33 Volt @ 125°C)													
301200101#104T*	TAJA104*050ESA	A	0.10	50	0.5	4	22	58	53	23	1285	1156	514
301200102#154T*	TAJB154*050ESA	B	0.15	50	0.5	4	17	71	64	28	1202	1082	481
301200102#224T*	TAJB224*050ESA	B	0.22	50	0.5	4	14	78	70	31	1091	982	436
301200102#334T*	TAJB334*050ESA	B	0.33	50	0.5	4	12	84	76	34	1010	909	404
301200113#474T*	TAJC474*050ESA	C	0.47	50	0.5	4	8	117	106	47	938	844	375
301200113#684T*	TAJC684*050ESA	C	0.68	50	0.5	4	7	125	113	50	877	790	351
301200113#105T*	TAJC105*050ESA	C	1.0	50	0.5	4	5.5	141	127	57	778	700	311
301200114#155T*	TAJD155*050ESA	D	1.5	50	0.8	6	4	194	174	77	775	697	310
301200114#225T*	TAJD225*050ESA	D	2.2	50	1.1	6	2.5	245	220	98	612	551	245
301200114#335T*	TAJD335*050ESA	D	3.3	50	1.7	6	2	274	246	110	548	493	219
301200114#475T*	TAJD475*050ESA	D	4.7	50	2.4	6	1.4	327	295	131	458	412	183
301200114#685T*	TAJD685*050ESA	D	6.8	50	3.4	6	1	387	349	155	387	349	155
301200117#106T*	TAJE106*050ESA	E	10	50	5	6	0.8	454	409	182	363	327	145

All technical data relates to an ambient temperature of +25°C. Capacitance and DF are measured at 120Hz, 0.5V RMS with a maximum DC bias of 2.2 volts. DCL is measured at rated voltage after 5 minutes.
 NOTE: KYOCERA AVX reserves the right to supply a higher voltage rating or tighter tolerance part in the same case size, to the same reliability standards.

TAJ ESCC TANTALUM CAPACITORS

SMD Solid Tantalum Chip Capacitors



RATINGS & PART NUMBER REFERENCE, Issue 9

ESCC Part No.	Part No.	Case Size	Capacitance (µF)	Rated Voltage (V)	DCL Max. (µA)	DF Max. (%)	ESR Max. @100kHz (Ω)	100kHz Ripple Current (mA) Ratings			100kHz Ripple Voltage (mV) Ratings		
								25°C	85°C	125°C	25°C	85°C	125°C
4 Volt @ 85°C (2.7 Volt @ 125°C)													
301200101335*G	TAJA335*004□C0A^	A	3.3	4	0.5	6	9	91	82	37	822	739	329
301200101475*G	TAJA475*004□C0A^	A	4.7	4	0.5	6	7.5	100	90	40	750	675	300
301200101685*G	TAJA685*004□C0A^	A	6.8	4	0.5	6	6.5	107	97	43	698	628	279
301200101106*G	TAJA106*004□C0A^	A	10	4	0.5	6	6	112	101	45	671	604	268
301200102106*G	TAJB106*004□C0A^	B	10	4	0.5	6	4	146	131	58	583	525	233
301200102156*G	TAJB156*004□C0A^	B	15	4	0.6	6	3	168	151	67	505	454	202
301200102226*G	TAJB226*004□C0A^	B	22	4	0.9	6	2.5	184	166	74	461	415	184
301200113226*G	TAJC226*004□C0A^	C	22	4	0.9	6	2.3	219	197	87	503	453	201
301200113336*G	TAJC336*004□C0A^	C	33	4	1.3	6	2	235	211	94	469	422	188
301200113476*G	TAJC476*004□C0A^	C	47	4	1.9	6	1.8	247	222	99	445	400	178
301200114476*G	TAJD476*004□C0A^	D	47	4	1.9	6	1.8	289	260	115	520	468	208
301200113686*G	TAJC686*004□C0A^	C	68	4	2.7	6	1.6	262	236	105	420	378	168
301200114686*G	TAJD686*004□C0A^	D	68	4	2.7	6	1.1	369	332	148	406	366	162
301200114107*G	TAJD107*004□C0A^	D	100	4	4	6	0.9	408	367	163	367	331	147
301200114157*G	TAJD157*004□C0A^	D	150	4	6	6	0.9	408	367	163	367	331	147
301200117227*G	TAJE227*004□C0A^	E	220	4	8.8	6	0.9	428	385	171	385	347	154
6.3 Volt @ 85°C (4 Volt @ 125°C)													
301200101225*J	TAJA225*006□C0A^	A	2.2	6.3	0.5	6	9	91	82	37	822	739	329
301200101335*J	TAJA335*006□C0A^	A	3.3	6.3	0.5	6	7	104	93	41	725	652	290
301200101475*J	TAJA475*006□C0A^	A	4.7	6.3	0.5	6	6	112	101	45	671	604	268
301200101685*J	TAJA685*006□C0A^	A	6.8	6.3	0.5	6	5	122	110	49	612	551	245
301200102685*J	TAJB685*006□C0A^	B	6.8	6.3	0.5	6	4	146	131	58	583	525	233
301200102106*J	TAJB106*006□C0A^	B	10	6.3	0.6	6	3	168	151	67	505	454	202
301200102156*J	TAJB156*006□C0A^	B	15	6.3	0.9	6	2	206	186	82	412	371	165
301200113156*J	TAJC156*006□C0A^	C	15	6.3	0.9	6	2.5	210	189	84	524	472	210
301200113226*J	TAJC226*006□C0A^	C	22	6.3	1.4	6	2	235	211	94	469	422	188
301200113336*J	TAJC336*006□C0A^	C	33	6.3	2.1	6	1.8	247	222	99	445	400	178
301200113476*J	TAJC476*006□C0A^	C	47	6.3	3	6	1.6	262	236	105	420	378	168
301200114476*J	TAJD476*006□C0A^	D	47	6.3	3	6	1.1	369	332	148	406	366	162
301200114686*J	TAJD686*006□C0A^	D	68	6.3	4.3	6	0.9	408	367	163	367	331	147
301200114107*J	TAJD107*006□C0A^	D	100	6.3	6.3	6	0.9	408	367	163	367	331	147
301200114157*J	TAJD157*006□C0A^	D	150	6.3	9.5	6	0.9	408	367	163	367	331	147
301200117227*J	TAJE227*006□C0A^	E	220	6.3	13.9	6	0.4	642	578	257	257	231	103
10 Volt @ 85°C (7 Volt @ 125°C)													
301200101155*A	TAJA155*010□C0A^	A	1.5	10	0.5	6	10	87	78	35	866	779	346
301200101225*A	TAJA225*010□C0A^	A	2.2	10	0.5	6	7	104	93	41	725	652	290
301200101335*A	TAJA335*010□C0A^	A	3.3	10	0.5	6	5.5	117	105	47	642	578	257
301200101475*A	TAJA475*010□C0A^	A	4.7	10	0.5	6	5	122	110	49	612	551	245
301200102475*A	TAJB475*010□C0A^	B	4.7	10	0.5	6	4	146	131	58	583	525	233
301200102685*A	TAJB685*010□C0A^	B	6.8	10	0.7	6	3	168	151	67	505	454	202
301200102106*A	TAJB106*010□C0A^	B	10	10	1	6	2.1	201	181	80	422	380	169
301200113106*A	TAJC106*010□C0A^	C	10	10	1	6	2.5	210	189	84	524	472	210
301200113156*A	TAJC156*010□C0A^	C	15	10	1.5	6	2	235	211	94	469	422	188
301200113226*A	TAJC226*010□C0A^	C	22	10	2.2	6	1.8	247	222	99	445	400	178
301200113336*A	TAJC336*010□C0A^	C	33	10	3.3	6	1.6	262	236	105	420	378	168
301200114336*A	TAJD336*010□C0A^	D	33	10	3.3	6	1.1	369	332	148	406	366	162
301200113476*A	TAJC476*010□C0A^	C	47	10	4.7	6	1.2	303	272	121	363	327	145
301200114476*A	TAJD476*010□C0A^	D	47	10	4.7	6	0.4	612	551	245	245	220	98
301200114686*A	TAJD686*010□C0A^	D	68	10	6.8	6	0.9	408	367	163	367	331	147
301200114107*A	TAJD107*010□C0A^	D	100	10	10	6	0.9	408	367	163	367	331	147
301200117157*A	TAJE157*010□C0A^	E	150	10	15	6	0.9	428	385	171	385	347	154
301200117227*A	TAJE227*010□C0A^	E	220	10	22	6	0.5	574	517	230	287	259	115
16 Volt @ 85°C (10 Volt @ 125°C)													
301200101105*C	TAJA105*016□C0A^	A	1.0	16	0.5	4	11	83	74	33	908	817	363
301200101155*C	TAJA155*016□C0A^	A	1.5	16	0.5	6	8	97	87	39	775	697	310
301200101225*C	TAJA225*016□C0A^	A	2.2	16	0.5	6	6.5	107	97	43	698	628	279
301200102225*C	TAJB225*016□C0A^	B	2.2	16	0.5	6	5.5	124	112	50	684	615	273
301200101335*C	TAJA335*016□C0A^	A	3.3	16	0.5	6	5	122	110	49	612	551	245
301200102335*C	TAJB335*016□C0A^	B	3.3	16	0.5	6	4.5	137	124	55	618	557	247
301200102475*C	TAJB475*016□C0A^	B	4.7	16	0.8	6	3.5	156	140	62	545	491	218
301200102685*C	TAJB685*016□C0A^	B	6.8	16	1.1	6	2.5	184	166	74	461	415	184
301200113685*C	TAJC685*016□C0A^	C	6.8	16	1.1	6	2.5	210	189	84	524	472	210

All technical data relates to an ambient temperature of +25°C. Capacitance and DF are measured at 120Hz, 0.5V RMS with a maximum DC bias of 2.2 volts. DCL is measured at rated voltage after 5 minutes. NOTE: KYOCERA AVX reserves the right to supply a higher voltage rating or tighter tolerance part in the same case size, to the same reliability standards.



The Important Information/Disclaimer is incorporated in the catalog where these specifications came from or available online at www.kyocera-avx.com/disclaimer/ by reference and should be reviewed in full before placing any order.

TAJ ESCC TANTALUM CAPACITORS

SMD Solid Tantalum Chip Capacitors



RATINGS & PART NUMBER REFERENCE, Issue 9

ESCC Part No.	Part No.	Case Size	Capacitance (µF)	Rated Voltage (V)	DCL Max. (µA)	DF Max. (%)	ESR Max. @100kHz (Ω)	100kHz Ripple Current (mA) Ratings			100kHz Ripple Voltage (mV) Ratings		
								25°C	85°C	125°C	25°C	85°C	125°C
301200113106*C	TAJC106*016□C0A^	C	10	16	1.6	6	2	235	211	94	469	422	188
301200113156*C	TAJC156*016□C0A^	C	15	16	2.4	6	1.8	247	222	99	445	400	178
301200113226*C	TAJC226*016□C0A^	C	22	16	3.5	6	1	332	298	133	332	298	133
301200114226*C	TAJD226*016□C0A^	D	22	16	3.5	6	1.1	369	332	148	406	366	162
301200114336*C	TAJD336*016□C0A^	D	33	16	5.3	6	0.9	408	367	163	367	331	147
301200114476*C	TAJD476*016□C0A^	D	47	16	7.5	6	0.9	408	367	163	367	331	147
301200114686*C	TAJD686*016□C0A^	D	68	16	10.9	6	0.9	408	367	163	367	331	147
301200117107*C	TAJE107*016□C0A^	E	100	16	16	6	0.9	428	385	171	385	347	154
20 Volt @ 85°C (13 Volt @ 125°C)													
301200101684*D	TAJA684*020□C0A^	A	0.68	20	0.5	4	12	79	71	32	949	854	379
301200101105*D	TAJA105*020□C0A^	A	1.0	20	0.5	4	9	91	82	37	822	739	329
301200101155*D	TAJA155*020□C0A^	A	1.5	20	0.5	6	6.5	107	97	43	698	628	279
301200102225*D	TAJB225*020□C0A^	B	2.2	20	0.5	6	3.5	156	140	62	545	491	218
301200102335*D	TAJB335*020□C0A^	B	3.3	20	0.7	6	3	168	151	67	505	454	202
301200102475*D	TAJB475*020□C0A^	B	4.7	20	0.9	6	3	168	151	67	505	454	202
301200113475*D	TAJC475*020□C0A^	C	4.7	20	0.9	6	2.8	198	178	79	555	499	222
301200113685*D	TAJC685*020□C0A^	C	6.8	20	1.4	6	2	235	211	94	469	422	188
301200113106*D	TAJC106*020□C0A^	C	10	20	2	6	1.2	303	272	121	363	327	145
301200113156*D	TAJC156*020□C0A^	C	15	20	3	6	1.7	254	229	102	432	389	173
301200114156*D	TAJD156*020□C0A^	D	15	20	3	6	1.1	369	332	148	406	366	162
301200114226*D	TAJD226*020□C0A^	D	22	20	4.4	6	0.9	408	367	163	367	331	147
301200114336*D	TAJD336*020□C0A^	D	33	20	6.6	6	0.9	408	367	163	367	331	147
301200117476*D	TAJE476*020□C0A^	E	47	20	9.4	6	0.9	428	385	171	385	347	154
301200117686*D	TAJE686*020□C0A^	E	68	20	13.6	6	0.9	428	385	171	385	347	154
25 Volt @ 85°C (17 Volt @ 125°C)													
301200101474*E	TAJA474*025□C0A^	A	0.47	25	0.5	4	14	73	66	29	1025	922	410
301200101684*E	TAJA684*025□C0A^	A	0.68	25	0.5	4	10	87	78	35	866	779	346
301200101105*E	TAJA105*025□C0A^	A	1.0	25	0.5	4	8	97	87	39	775	697	310
301200102155*E	TAJB155*025□C0A^	B	1.5	25	0.5	6	5	130	117	52	652	587	261
301200102225*E	TAJB225*025□C0A^	B	2.2	25	0.6	6	4.5	137	124	55	618	557	247
301200102335*E	TAJB335*025□C0A^	B	3.3	25	0.8	6	3.5	156	140	62	545	491	218
301200113335*E	TAJC335*025□C0A^	C	3.3	25	0.8	6	2.8	198	178	79	555	499	222
301200113475*E	TAJC475*025□C0A^	C	4.7	25	1.2	6	2.4	214	193	86	514	462	206
301200113685*E	TAJC685*025□C0A^	C	6.8	25	1.7	6	2	235	211	94	469	422	188
301200114685*E	TAJD685*025□C0A^	D	6.8	25	1.7	6	1.4	327	295	131	458	412	183
301200113106*E	TAJC106*025□C0A^	C	10	25	2.5	6	1.8	247	222	99	445	400	178
301200114106*E	TAJD106*025□C0A^	D	10	25	2.5	6	1.2	354	318	141	424	382	170
301200114156*E	TAJD156*025□C0A^	D	15	25	3.8	6	1	387	349	155	387	349	155
301200114226*E	TAJD226*025□C0A^	D	22	25	5.5	6	0.9	408	367	163	367	331	147
301200117336*E	TAJE336*025□C0A^	E	33	25	8.3	6	0.9	428	385	171	385	347	154
35 Volt @ 85°C (23 Volt @ 125°C)													
301200101104*V	TAJA104*035□C0A^	A	0.10	35	0.5	4	24	56	50	22	1342	1207	537
301200101154*V	TAJA154*035□C0A^	A	0.15	35	0.5	4	21	60	54	24	1255	1129	502
301200101224*V	TAJA224*035□C0A^	A	0.22	35	0.5	4	18	65	58	26	1162	1046	465
301200101334*V	TAJA334*035□C0A^	A	0.33	35	0.5	4	15	71	64	28	1061	955	424
301200101474*V	TAJA474*035□C0A^	A	0.47	35	0.5	4	12	79	71	32	949	854	379
301200102474*V	TAJB474*035□C0A^	B	0.47	35	0.5	4	10	92	83	37	922	830	369
301200101684*V	TAJA684*035□C0A^	A	0.68	35	0.5	4	8	97	87	39	775	697	310
301200102684*V	TAJB684*035□C0A^	B	0.68	35	0.5	4	8	103	93	41	825	742	330
301200102105*V	TAJB105*035□C0A^	B	1.0	35	0.5	4	6.5	114	103	46	743	669	297
301200102155*V	TAJB155*035□C0A^	B	1.5	35	0.5	6	5.2	128	115	51	665	598	266
301200113155*V	TAJC155*035□C0A^	C	1.5	35	0.5	6	4.5	156	141	63	704	633	281
301200102225*V	TAJB225*035□C0A^	B	2.2	35	0.8	6	4.2	142	128	57	597	538	239
301200113225*V	TAJC225*035□C0A^	C	2.2	35	0.8	6	3.5	177	160	71	620	558	248
301200113335*V	TAJC335*035□C0A^	C	3.3	35	1.2	6	2.5	210	189	84	524	472	210
301200113475*V	TAJC475*035□C0A^	C	4.7	35	1.6	6	2.2	224	201	89	492	443	197
301200114475*V	TAJD475*035□C0A^	D	4.7	35	1.6	6	1.5	316	285	126	474	427	190
301200114685*V	TAJD685*035□C0A^	D	6.8	35	2.4	6	1.3	340	306	136	442	397	177
301200114106*V	TAJD106*035□C0A^	D	10	35	3.5	6	1	387	349	155	387	349	155
301200114156*V	TAJD156*035□C0A^	D	15	35	5.3	6	0.9	408	367	163	367	331	147
301200117226*V	TAJE226*035□C0A^	E	22	35	7.7	6	0.5	574	517	230	287	259	115

All technical data relates to an ambient temperature of +25°C. Capacitance and DF are measured at 120Hz, 0.5V RMS with a maximum DC bias of 2.2 volts. DCL is measured at rated voltage after 5 minutes. NOTE: KYOCERA AVX reserves the right to supply a higher voltage rating or tighter tolerance part in the same case size, to the same reliability standards.

TAJ ESCC TANTALUM CAPACITORS

SMD Solid Tantalum Chip Capacitors



RATINGS & PART NUMBER REFERENCE, Issue 9

ESCC Part No.	Part No.	Case Size	Capacitance (µF)	Rated Voltage (V)	DCL Max. (µA)	DF Max. (%)	ESR Max. @100kHz (Ω)	100kHz Ripple Current (mA) Ratings			100kHz Ripple Voltage (mV) Ratings		
								25°C	85°C	125°C	25°C	85°C	125°C
50 Volt @ 85°C (33 Volt @ 125°C)													
301200101104*T	TAJA104*050□C0A^	A	0.10	50	0.5	4	22	58	53	23	1285	1156	514
301200102154*T	TAJB154*050□C0A^	B	0.15	50	0.5	4	17	71	64	28	1202	1082	481
301200102224*T	TAJB224*050□C0A^	B	0.22	50	0.5	4	14	78	70	31	1091	982	436
301200102334*T	TAJB334*050□C0A^	B	0.33	50	0.5	4	12	84	76	34	1010	909	404
301200113474*T	TAJC474*050□C0A^	C	0.47	50	0.5	4	8	117	106	47	938	844	375
301200113684*T	TAJC684*050□C0A^	C	0.68	50	0.5	4	7	125	113	50	877	790	351
301200113105*T	TAJC105*050□C0A^	C	1.0	50	0.5	4	5.5	141	127	57	778	700	311
301200114155*T	TAJD155*050□C0A^	D	1.5	50	0.8	6	4	194	174	77	775	697	310
301200114225*T	TAJD225*050□C0A^	D	2.2	50	1.1	6	2.5	245	220	98	612	551	245
301200114335*T	TAJD335*050□C0A^	D	3.3	50	1.7	6	2	274	246	110	548	493	219
301200114475*T	TAJD475*050□C0A^	D	4.7	50	2.4	6	1.4	327	295	131	458	412	183
301200114685*T	TAJD685*050□C0A^	D	6.8	50	3.4	6	1	387	349	155	387	349	155
301200117106*T	TAJE106*050□C0A^	E	10	50	5	6	0.8	454	409	182	363	327	145

All technical data relates to an ambient temperature of +25°C. Capacitance and DF are measured at 120Hz, 0.5V RMS with a maximum DC bias of 2.2 volts. DCL is measured at rated voltage after 5 minutes. NOTE: KYOCERA AVX reserves the right to supply a higher voltage rating or tighter tolerance part in the same case size, to the same reliability standards.

TES LOW ESR – QPL ESCC

Low ESR Tantalum Chip Capacitor

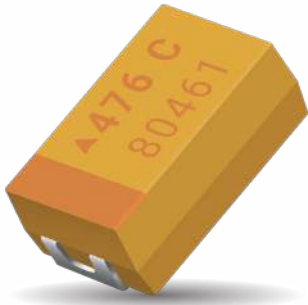

- QPL ESCC approved series
- Manufactured in EU, ESA qualified plant, according to ESCC 3012
- Detailed specification 3012/004
- Low ESR designed parts, multianode D and E case included
- Robust against higher thermo-mechanical stresses during assembly process
- CV range 1.0 - 470uF/6.3 - 50V
- Improved reliability design



For additional information on Q-process please consult the KYOCERA AVX technical publication [“Reaching the Highest Reliability for Tantalum Capacitors”](#)

CASE DIMENSIONS: millimeters (inches)

Code	EIA Code	Variant	L±0.20 (0.008)	W+0.20(0.008) -0.10 (0.004)	H+0.20 (0.008) -0.10 (0.004)	W ₁ ±0.20 (0.008)	A+0.30 (0.012) -0.20 (0.008)	S Min.
A	3216-18	01	3.20 (0.126)	1.60 (0.063)	1.60 (0.063)	1.20 (0.047)	0.80 (0.031)	1.10 (0.043)
B	3528-21	02	3.50 (0.138)	2.80 (0.110)	1.90 (0.075)	2.20 (0.087)	0.80 (0.031)	1.40 (0.055)
C	6032-28	03	6.00 (0.236)	3.20 (0.126)	2.60 (0.102)	2.20 (0.087)	1.30 (0.051)	2.90 (0.114)
D	7343-31	04	7.30 (0.287)	4.30 (0.169)	2.90 (0.114)	2.40 (0.094)	1.30 (0.051)	4.40 (0.173)
E	7343-43	05	7.30 (0.287)	4.30 (0.169)	4.10 (0.162)	2.40 (0.094)	1.30 (0.051)	4.40 (0.173)

W₁ dimension applies to the termination width for A dimensional area only.

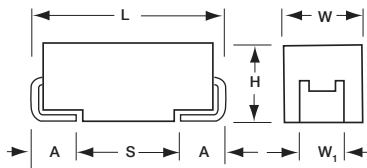

MARKING A, B, C, D, E CASE

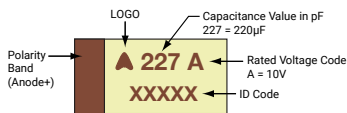

ESCC DETAIL SPECIFICATION No. 3012/004 Issue 4 -Reference for open orders only HOW TO ORDER PART NUMBER

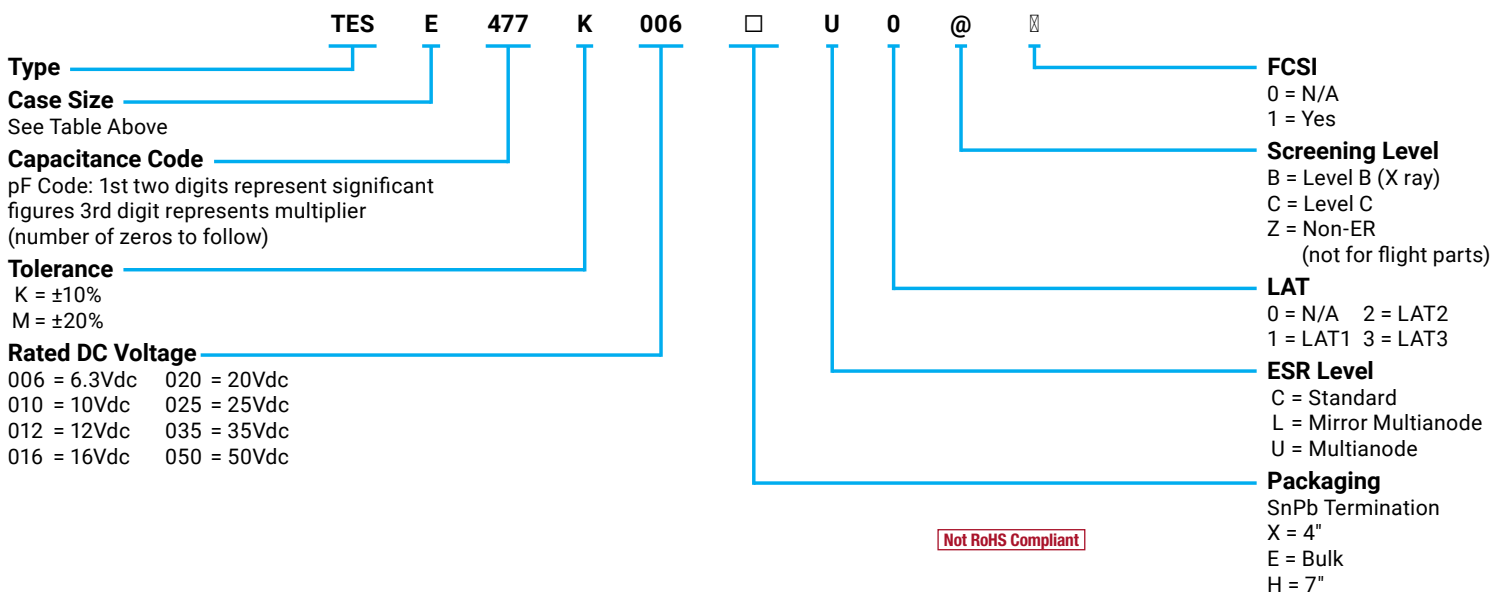

TES LOW ESR – QPL ESCC

Low ESR Tantalum Chip Capacitor

ESCC PART NUMBER – MANDATORY FOR ORDERING:

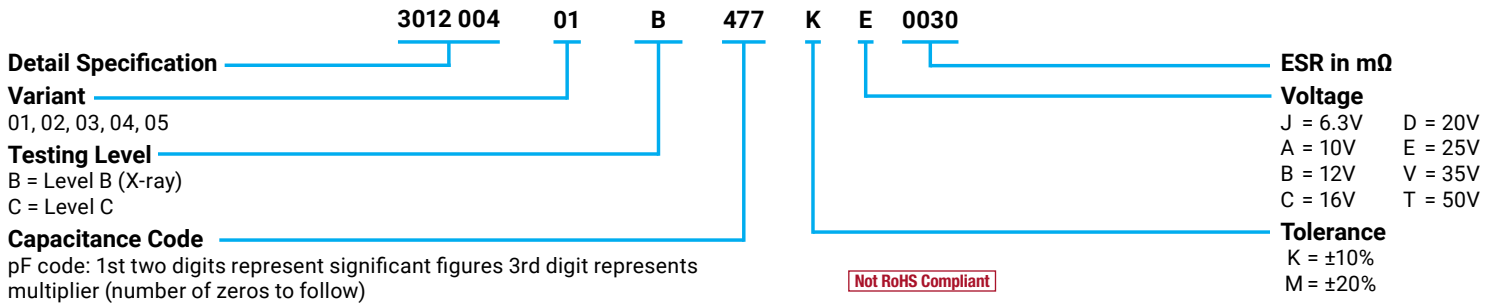

ESCC DETAIL SPECIFICATION No. 3012/004 Issue 6 HOW TO ORDER PART NUMBER:

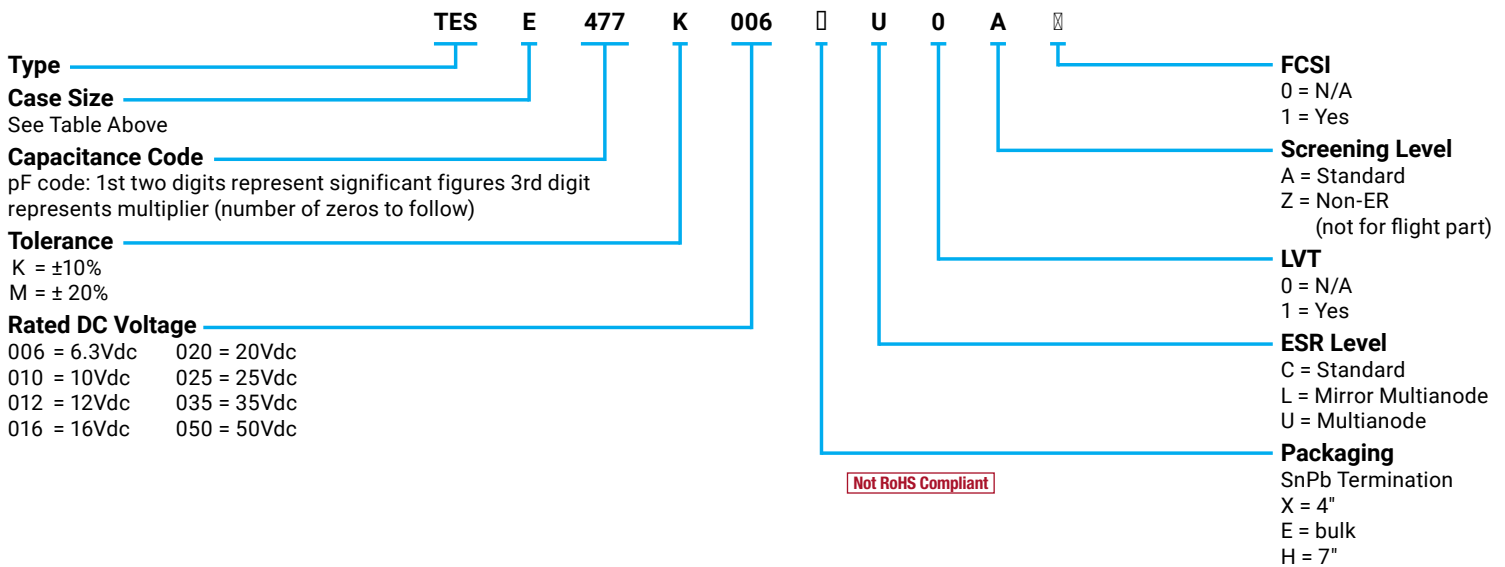

ESCC PART NUMBER – MANDATORY FOR ORDERING:

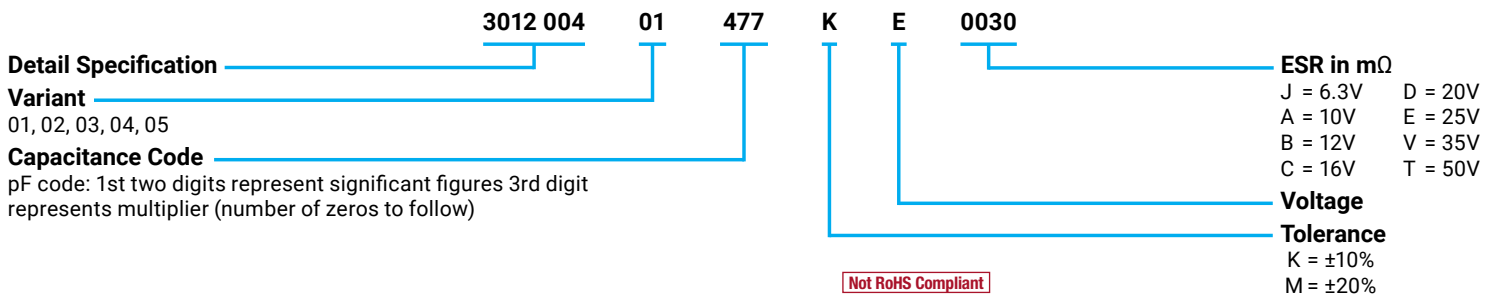

TES LOW ESR – QPL ESCC

Low ESR Tantalum Chip Capacitor



CAPACITANCE AND RATED VOLTAGE, V_R (VOLTAGE CODE) RANGE (LETTER DENOTES CASE SIZE)

Capacitance		Rated Voltage DC (V _R) at 85°C							
μF	Code	6.3V (J)	10V (A)	12V (B)	16V (C)	20V (D)	25V (E)	35V (V)	50V (T)
1.0	105						A(3000)		B(2000)
1.5	155								
2.2	225								
3.3	335					A(2500)		B(1000)	C(1000)
4.7	475				A(2000)		B(1000)	C(600)	D(200)
6.8	685								
10	106		A(1800)			B(1000)	C(600)	D(120)	
15	156								
22	226	A(900)			B(600)	C(400)		D(100)	
33	336		B(650)			C(300)	D(65)	E(65)	
47	476	B(500)			C(350)	D(55)	E(65)		
68	686								
100	107		C(200)		D(55)	E(45)			
150	157	C(300)	D(45)		E(40)				
220	227		D(35)	E(35)					
330	337	D(35)	E(35)						
470	477	E(30)							

Available Ratings: ESR limits quoted in brackets (mOhms)

OPTION

Packaging: Tape and reel available on request – Contact manufacturer

RATINGS & PART NUMBER REFERENCE, Issue 4 -Reference for open orders only

ESCC Part No.	Part No.	Case Size	Capacitance (μF)	Rated Voltage (V)	DCL Max. (μA)	DF Max. (%)	ESR Max. @100kHz (mΩ)	100kHz Ripple Current (mA) Ratings			100kHz Ripple Voltage (mV) Ratings		
								25°C	85°C	125°C	25°C	85°C	125°C
6.3 Volt @ 85°C (4 Volt @ 125°C)													
301200401#226*J0900	TESA226*006□C0@^	A	22	6.3	1.32	6	900	289	260	115	260	234	104
301200402#476*J0500	TESB476*006□C0@^	B	47	6.3	2.82	6	500	412	371	165	206	186	82
301200403#157*J0300	TESC157*006□C0@^	C	150	6.3	9	6	300	606	545	242	182	163	73
301200404#337*J0035	TESD337*006□L0@^	D	330	6.3	19.8	8	35	2699	2429	1080	94	85	38
301200405#477*J0030	TESE477*006□U0@^	E	470	6.3	28.2	6	30	3000	2700	1200	90	81	36
10 Volt @ 85°C (7 Volt @ 125°C)													
301200401#106*A1800	TESA106*010□C0@^	A	10	10	1	6	1800	204	184	82	367	331	147
301200402#336*A0650	TESB336*010□C0@^	B	33	10	3.3	6	650	362	325	145	235	212	94
301200403#107*A0200	TESC107*010□C0@^	C	100	10	10	6	200	742	667	297	148	133	59
301200404#157*A0045	TESD157*010□L0@^	D	150	10	15	6	45	2380	2142	952	107	96	43
301200404#227*A0035	TESD227*010□L0@^	D	220	10	22	6	35	2699	2429	1080	94	85	38
301200405#337*A0035	TESE337*010□U0@^	E	330	10	33	6	35	2777	2500	1111	97	87	39
12 Volt @ 85°C (8 Volt @ 125°C)													
301200405#227*B0035	TESE227*012□U0@^	E	220	12	26.4	6	35	2777	2500	1111	97	87	39
16 Volt @ 85°C (10 Volt @ 125°C)													
301200401#475*C2000	TESA475*016□C0@^	A	4.7	16	0.75	6	2000	194	174	77	387	349	155
301200402#226*C0600	TESB226*016□C0@^	B	22	16	3.52	6	600	376	339	151	226	203	90
301200403#476*C0350	TESC476*016□C0@^	C	47	16	7.52	6	350	561	505	224	196	177	78
301200404#107*C0055	TESD107*016□L0@^	D	100	16	16	6	55	2153	1938	861	118	107	47
301200405#157*C0040	TESE157*016□U0@^	E	150	16	24	6	40	2598	2338	1039	104	94	42
20 Volt @ 85°C (13 Volt @ 125°C)													
301200401#335*D2500	TESA335*020□C0@^	A	3.3	20	0.66	6	2500	173	156	69	433	390	173
301200402#106*D1000	TESB106*020□C0@^	B	10	20	2	6	1000	292	262	117	292	262	117
301200403#226*D0400	TESC226*020□C0@^	C	22	20	4.4	6	400	524	472	210	210	189	84
301200403#336*D0300	TESC336*020□C0@^	C	33	20	6.6	6	300	606	545	242	182	163	73
301200404#476*D0055	TESD476*020□L0@^	D	47	20	9.4	6	55	2153	1938	861	118	107	47
301200405#107*D0045	TESE107*020□U0@^	E	100	20	20	6	45	2449	2205	980	110	99	44
25 Volt @ 85°C (17 Volt @ 125°C)													
301200401#105*E3000	TESA105*025□C0@^	A	1.0	25	0.25	6	3000	158	142	63	474	427	190
301200402#475*E1000	TESB475*025□C0@^	B	4.7	25	1.18	6	1000	292	262	117	292	262	117
301200403#106*E0600	TESC106*025□C0@^	C	10	25	2.5	6	600	428	385	171	257	231	103
301200404#336*E0065	TESD336*025□L0@^	D	33	25	8.25	6	65	1981	1783	792	129	116	51
301200405#476*E0065	TESE476*025□U0@^	E	47	25	11.8	6	65	2038	1834	815	132	119	53

The parts are supplied in dry pack with Moisture Sensitivity Level (MSL) level 3 - defined according to J-STD-020. All technical data relates to an ambient temperature of +25°C. Capacitance and DF are measured at 120Hz, 0.5V RMS with a maximum DC bias of 2.2 volts. DCL is measured at rated voltage after 5 minutes.

NOTE: KYOCERA KYOCERA AVX reserves the right to supply a higher voltage rating or tighter tolerance part in the same case size, to the same reliability standards.

TES LOW ESR – QPL ESCC

Low ESR Tantalum Chip Capacitor



ESCC Part No.	Part No.	Case Size	Capacitance (µF)	Rated Voltage (V)	DCL Max. (µA)	DF Max. (%)	ESR Max. @100kHz (mΩ)	100kHz Ripple Current (mA)			100kHz Ripple Voltage (mV)		
								25°C	85°C	125°C	25°C	85°C	125°C
35 Volt @ 85°C (23 Volt @ 125°C)													
301200402#335*V1000	TESB335*035□C0@^A	B	3.3	35	1.16	6	1000	292	262	117	292	262	117
301200403#475*V0600	TESC475*035□C0@^A	C	4.7	35	1.65	6	600	428	385	171	257	231	103
301200404#106*V0120	TESD106*035□L0@^A	D	10	35	3.5	6	120	1458	1312	583	175	157	70
301200404#226*V0100	TESD226*035□L0@^A	D	22	35	7.7	6	100	1597	1437	639	160	144	64
301200405#336*V0065	TESE336*035□U0@^A	E	33	35	11.6	6	65	2038	1834	815	132	119	53
50 Volt @ 85°C (33 Volt @ 125°C)													
301200402#105*T2000	TESB105*050□C0@^A	B	1.0	50	0.5	6	2000	206	186	82	412	271	165
301200403#335*T1000	TESC335*050□C0@^A	C	3.3	50	1.65	6	1000	332	298	133	332	298	133
301200404#475*T0200	TESD475*050□L0@^A	D	4.7	50	2.35	6	200	1129	1016	452	226	203	90

The parts are supplied in dry pack with Moisture Sensitivity Level (MSL) level 3 - defined according to J-STD-020. All technical data relates to an ambient temperature of +25°C. Capacitance and DF are measured at 120Hz, 0.5V RMS with a maximum DC bias of 2.2 volts. DCL is measured at rated voltage after 5 minutes.

NOTE: KYOCERA AVX reserves the right to supply a higher voltage rating or tighter tolerance part in the same case size, to the same reliability standards.

RATINGS & PART NUMBER REFERENCE, Issue 6

ESCC Part No.	Part No.	Case Size	Capacitance (µF)	Rated Voltage (V)	DCL Max. (µA)	DF Max. (%)	ESR Max. @100kHz (mΩ)	100kHz Ripple Current (mA)			100kHz Ripple Voltage (mV)		
								25°C	85°C	125°C	25°C	85°C	125°C
6.3 Volt @ 85°C (4 Volt @ 125°C)													
301200401226*J0900	TESA226*006□C0A^A	A	22	6.3	1.32	6	900	289	260	115	260	234	104
301200402476*J0500	TESB476*006□C0A^B	B	47	6.3	2.82	6	500	412	371	165	206	186	82
301200403157*J0300	TESC157*006□C0A^C	C	150	6.3	9	6	300	606	545	242	182	163	73
301200404337*J0035	TESD337*006□L0A^D	D	330	6.3	19.8	8	35	2699	2429	1080	94	85	38
301200405477*J0030	TESE477*006□U0A^E	E	470	6.3	28.2	6	30	3000	2700	1200	90	81	36
10 Volt @ 85°C (7 Volt @ 125°C)													
301200401106*A1800	TESA106*010□C0A^A	A	10	10	1	6	1800	204	184	82	367	331	147
301200402336*A0650	TESB336*010□C0A^B	B	33	10	3.3	6	650	362	325	145	235	212	94
301200403107*A0200	TESC107*010□C0A^C	C	100	10	10	6	200	742	667	297	148	133	59
301200404157*A0045	TESD157*010□L0A^D	D	150	10	15	6	45	2380	2142	952	107	96	43
301200404227*A0035	TESD227*010□L0A^D	D	220	10	22	6	35	2699	2429	1080	94	85	38
301200405337*A0035	TESE337*010□U0A^E	E	330	10	33	6	35	2777	2500	1111	97	87	39
12 Volt @ 85°C (8 Volt @ 125°C)													
301200405227*B0035	TESE227*012□U0A^E	E	220	12	26.4	6	35	2777	2500	1111	97	87	39
16 Volt @ 85°C (10 Volt @ 125°C)													
301200401475*C2000	TESA475*016□C0A^A	A	4.7	16	0.75	6	2000	194	174	77	387	349	155
301200402226*C0600	TESB226*016□C0A^B	B	22	16	3.52	6	600	376	339	151	226	203	90
301200403476*C0350	TESC476*016□C0A^C	C	47	16	7.52	6	350	561	505	224	196	177	78
301200404107*C0055	TESD107*016□L0A^D	D	100	16	16	6	55	2153	1938	861	118	107	47
301200405157*C0040	TESE157*016□U0A^E	E	150	16	24	6	40	2598	2338	1039	104	94	42
20 Volt @ 85°C (13 Volt @ 125°C)													
301200401335*D2500	TESA335*020□C0A^A	A	3.3	20	0.66	6	2500	173	156	69	433	390	173
301200402106*D1000	TESB106*020□C0A^B	B	10	20	2	6	1000	292	262	117	292	262	117
301200403226*D0400	TESC226*020□C0A^C	C	22	20	4.4	6	400	524	472	210	210	189	84
301200403336*D0300	TESC336*020□C0A^C	C	33	20	6.6	6	300	606	545	242	182	163	73
301200404476*D0055	TESD476*020□L0A^D	D	47	20	9.4	6	55	2153	1938	861	118	107	47
301200405107*D0045	TESE107*020□U0A^E	E	100	20	20	6	45	2449	2205	980	110	99	44
25 Volt @ 85°C (17 Volt @ 125°C)													
301200401105*E3000	TESA105*025□C0A^A	A	1.0	25	0.25	6	3000	158	142	63	474	427	190
301200402475*E1000	TESB475*025□C0A^B	B	4.7	25	1.18	6	1000	292	262	117	292	262	117
301200403106*E0600	TESC106*025□C0A^C	C	10	25	2.5	6	600	428	385	171	257	231	103
301200404336*E0065	TESD336*025□L0A^D	D	33	25	8.25	6	65	1981	1783	792	129	116	51
301200405476*E0065	TESE476*025□U0A^E	E	47	25	11.8	6	65	2038	1834	815	132	119	53
35 Volt @ 85°C (23 Volt @ 125°C)													
301200402335*V1000	TESB335*035□C0A^A	B	3.3	35	1.16	6	1000	292	262	117	292	262	117
301200403475*V0600	TESC475*035□C0A^A	C	4.7	35	1.65	6	600	428	385	171	257	231	103
301200404106*V0120	TESD106*035□L0A^A	D	10	35	3.5	6	120	1458	1312	583	175	157	70
301200404226*V0100	TESD226*035□L0A^A	D	22	35	7.7	6	100	1597	1437	639	160	144	64
301200405336*V0065	TESE336*035□U0A^A	E	33	35	11.6	6	65	2038	1834	815	132	119	53
50 Volt @ 85°C (33 Volt @ 125°C)													
301200402105*T2000	TESB105*050□C0A^A	B	1.0	50	0.5	6	2000	206	186	82	412	271	165
301200403335*T1000	TESC335*050□C0A^A	C	3.3	50	1.65	6	1000	332	298	133	332	298	133
301200404475*T0200	TESD475*050□L0A^A	D	4.7	50	2.35	6	200	1129	1016	452	226	203	90

The parts are supplied in dry pack with Moisture Sensitivity Level (MSL) level 3 - defined according to J-STD-020. All technical data relates to an ambient temperature of +25°C. Capacitance and DF are measured at 120Hz, 0.5V RMS with a maximum DC bias of 2.2 volts. DCL is measured at rated voltage after 5 minutes.

NOTE: KYOCERA AVX reserves the right to supply a higher voltage rating or tighter tolerance part in the same case size, to the same reliability standards.

TAJ CECC TANTALUM CAPACITORS

SMD Solid Tantalum Chip Capacitors



Capacitors, Fixed, Leadless Surface Mount, Chip, Solid electrolyte Tantalum for use in avionics and industrial applications, tested to CECC Specification 30801-005 and 30801-011 (CTC4).



CASE DIMENSIONS: millimeters (inches)

Code	EIA Code	Variant	L±0.20 (0.008)	W+0.20 (0.008) -0.10 (0.004)	H+0.20 (0.008) -0.10 (0.004)	W ₁ ±0.20 (0.008)	A+0.30 (0.012) -0.20 (0.008)	S Min.
A	3216-18	01&11	3.20 (0.126)	1.60 (0.063)	1.60 (0.063)	1.20 (0.047)	0.80 (0.031)	1.10 (0.043)
B	3528-21	02&12	3.50 (0.138)	2.80 (0.110)	1.90 (0.075)	2.20 (0.087)	0.80 (0.031)	1.40 (0.055)
C	6032-28	03&13	6.00 (0.236)	3.20 (0.126)	2.60 (0.102)	2.20 (0.087)	1.30 (0.051)	2.90 (0.114)
D	7343-31	04&14	7.30 (0.287)	4.30 (0.169)	2.90 (0.114)	2.40 (0.094)	1.30 (0.051)	4.40 (0.173)

W1 dimension applies to the termination width for A dimensional area only.

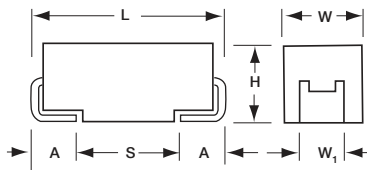

MARKING

A, B, C, D CASE

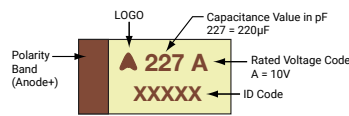

CAPACITANCE AND RATED VOLTAGE, V_R (VOLTAGE CODE) RANGE (LETTER DENOTES CASE SIZE)

BS CECC30801-005

Capacitance		Rated Voltage DC (V _R) at 85°C						
µF	Code	6.3V (J)	10V (A)	16V (C)	20V (D)	25V (E)	35V (V)	50V (T)
0.10	104						A	A
0.15	154						A	A/B
0.22	224						A	A/B
0.33	334						A	B
0.47	474					A	A/B	C
0.68	684				A	A	A/B	C
1.0	105			A	A	A	B	C
1.5	155		A	A	A	A/B	B/C	D
2.2	225	A	A	A/B	B	B	B/C	D
3.3	335	A	A	A/B	B	B/C	C/D	D
4.7	475	A	A/B	B	B/C	C	C/D	D
6.8	685	A/B	B	B/C	C/D	C/D	D	D
10	106	A/B	B/C	B/C/D	C	C/D	D	
15	156	B/C	B/C/D	C	C/D	D	D	
22	226	B/C/D	C	C/D	D	D		
33	336	C	C/D	D	D			
47	476	C/D	D	D				
68	686	C/D	D	D				
100	107	D	D					

BS CECC30801-011 (CTC4)

Capacitance		Rated Voltage DC (V _R) at 85°C						
µF	Code	6.3V (J)	10V (A)	16V (C)	20V (D)	25V (E)	35V (V)	50V (T)
0.10	104						A	A
0.15	154						A	B
0.22	224						A	B
0.33	334						A	B
0.47	474					A	B	C
0.68	684				A		B	C
1.0	105			A			B	C
1.5	155		A			B	C	D
2.2	225	A			B		C	D
3.3	335			B			C	D
4.7	475		B			C	D	D
6.8	685	B			C		D	
10	106			C		D	D	
15	156		C		D	D		
22	226	C		D	D			
33	336		D	D				
47	476	D	D					
68	686	D						

NOTE: Voltage ratings are minimum values. KYOCERA AVX reserves the rights to supply higher voltage rating in the same case size, to the same reliability standards.

TAJ CECC TANTALUM CAPACITORS

SMD Solid Tantalum Chip Capacitors

HOW TO ORDER

TAJ	A	475	K	010	R	FJ
Type	Case Size See table above	Capacitance Code pF code: 1st two digits represent significant figures 3rd digit represents multiplier (number of zeros to follow)	Tolerance K = ±10% M = ±20%	Rated DC Voltage 006 = 6.3Vdc 010 = 10Vdc 016 = 16Vdc 020 = 20Vdc 025 = 25Vdc 035 = 35Vdc 050 = 50Vdc	Termination Finish R = 7" T/R 100% Tin S = 13" T/R 100% Tin A = Gold Plating 7" Reel B = Gold Plating 13" Reel H = Tin Lead 7" Reel K = Tin Lead 13" Reel	Suffix FJ = CECC 30801-011(CTC4) Y = CECC 30801-005

LEAD-FREE
LEAD-FREE COMPATIBLE COMPONENT

RoHS
COMPLIANT

For RoHS compliant products, please select correct termination style.

TECHNICAL SPECIFICATIONS

Technical Data:	All technical data relate to an ambient temperature of +25°C								
Capacitance Range:	0.10 µF to 100 µF								
Capacitance Tolerance:	±10%; ±20%								
Rated Voltage DC (V _R)	≤ +85°C:	6.3	10	16	20	25	35	50	
Category Voltage (V _C)	≤ +125°C:	4	7	10	13	17	23	33	
Surge Voltage (V _S)	≤ +85°C:	8	13	20	26	32	46	65	
Surge Voltage (V _S)	≤ +125°C:	5	8	13	16	20	28	40	
Temperature Range:	-55°C to +125°C								
Reliability:	1% per 1000 hours at 85°C, V _R with 0.1Ω/V series Impedance, 60% confidence level								

TCH LOW ESR HERMETIC SERIES

SMD Low ESR Conductive Polymer Capacitors in Hermetic package, COTS-Plus



FEATURES

- Aerospace & Hi-Rel applications
- Low ESR conductive polymer electrode
- 100% surge current tested
- Ceramic case hermetic packaging
- Stability under humidity and ambient atmosphere exposure
- Large case sizes including CTC-21D provide high capacitance values
- Specific codes meet NASA EEE-INST-002, Level 2 requirements



Elekra Award 2015

MARKING

9 CASE

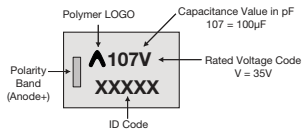

APPLICATIONS

- Aerospace
- Defence
- Power supplies
- Pulse power

CASE DIMENSIONS: millimeters (inches)

Code	Type	L	W	H Max.	W ₁	W ₂	A	S Min.
9 (CTC-21D)	J-lead (C-shape)	12.00 ± 0.50 (0.472 ± 0.020)	12.50 ± 0.50 (0.492 ± 0.020)	8.45 (0.333)	12.30 ± 0.50 (0.484 ± 0.020)	4.15 ± 0.10 (0.163 ± 0.004)	2.30 ± 0.50 (0.091 ± 0.020)	6.50 (0.256)
9 (CTC-21D)	J-lead (L-shape)	11.50 ± 0.50 (0.453 ± 0.020)	12.50 ± 0.50 (0.492 ± 0.020)	6.15 (0.242)	12.50 ± 0.50 (0.492 ± 0.020)	-	1.90 ± 0.50 (0.075 ± 0.020)	7.00 (0.276)
9 (CTC-21D)	Undertab	11.00 ± 0.20 (0.433 ± 0.008)	12.50 ± 0.20 (0.492 ± 0.008)	5.95 (0.234)	10.50 ± 0.20 (0.413 ± 0.008)	-	1.50 ± 0.20 (0.059 ± 0.008)	7.80 (0.307)

'J' Lead Termination (C-shape)

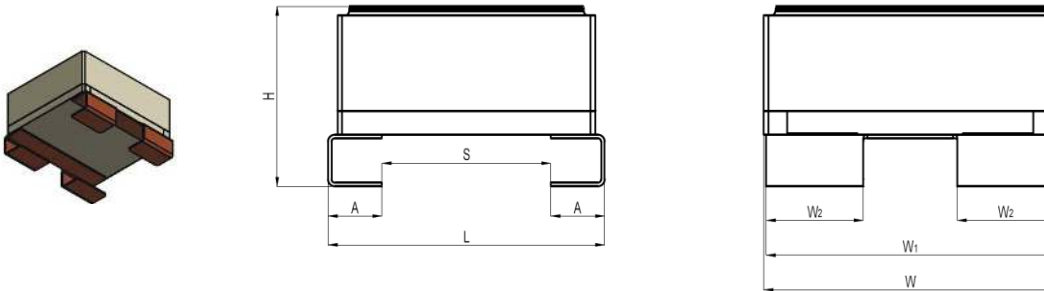

'J' Lead Termination (L-shape)

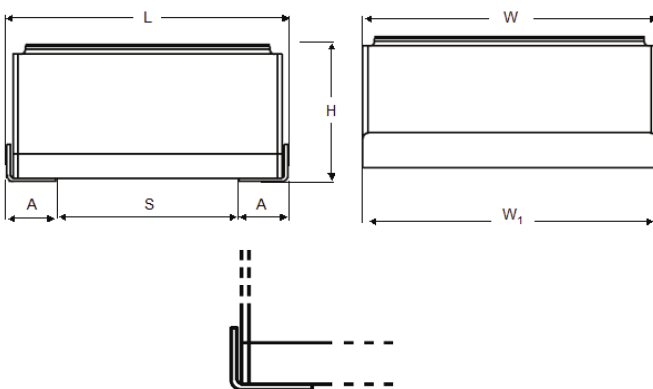

Undertab Termination

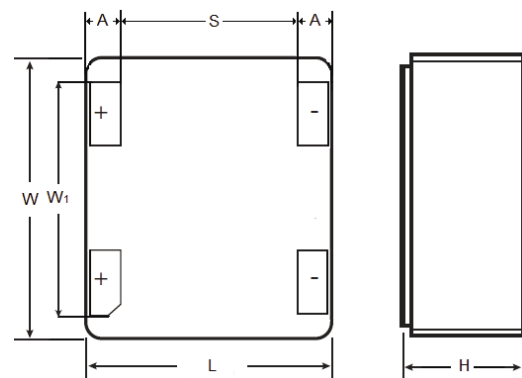

TCH LOW ESR HERMETIC SERIES

SMD Low ESR Conductive Polymer Capacitors in Hermetic package, COTS-Plus



TECHNICAL SPECIFICATIONS

Technical Data:	All technical data relate to an ambient temperature of +25°C								
Capacitance Range:	22 µF to 330 µF (for extended range under development, contact manufacturer)								
Capacitance Tolerance:	±20%								
Leakage Current DCL:	0.1CV								
Rated Voltage (VR)	≤ +85°C:	10	16	25	35	50	75	100	
Category Voltage (VC)	≤ +125°C:	7	11	17	23	33	50	66	
Temperature Range:	-55°C to +125°C								
Termination Finish:	Gold Plating (Undertab), Gold Plating (J-lead/L-shape), Sn/Pb Plating (J-lead/ C-shape, L-shape)								

HOW TO ORDER

PART NUMBER

TCH	9	227	M	016	W	0	040	#
Type	Case Size	Capacitance Code	Tolerance	Rated DC Voltage	Packaging	Qualification Level	ESR in mΩ	Termination
	See table above	pF code: 1st two digits represent significant figures 3rd digit represents multiplier (number of zeros to follow)	M = ±20%	010 = 10Vdc 016 = 16Vdc 025 = 25Vdc 035 = 35Vdc 050 = 50Vdc 075 = 75Vdc 100 = 100Vdc	W = Waffle	0 = Standard (contact manufacturer) S = Space (according to NASA EEE-INST-002, Level 2 requirements)		C = 'J' lead C-shape (Sn/Pb) J = 'J' lead L-shape (Gold) L = 'J' lead L-shape (Sn/Pb) U = Undertab C, L = Non RoHS



CAPACITANCE AND VOLTAGE RANGE (CASE CODE BEFORE THE BRACKETS)

Capacitance		Rated Voltage DC (VR) at 85°C						
µF	Code	10V (A)	16V (C)	25V (E)	35V (V)	50V (T)	75V (P)	100V (A)
22	226							9(150)
33	336						9(120)	
47	476					9(70)		
68	686							
100	107				9(55)			
150	157			9(50)	9(55)			
220	227		9(40)					
330	337	9(40)						

Released ratings, (ESR ratings in mOhms in parentheses)

TCH LOW ESR HERMETIC SERIES

SMD Low ESR Conductive Polymer Capacitors in Hermetic package, COTS-Plus



RATINGS & PART NUMBER REFERENCE

Part No.	Case Size	Capacitance (μF)	Rated Voltage (V)	Rated Temperature (°C)	Category Voltage (V)	Category Temperature (°C)	DCL Max. (μA)	DF Max. (%)	ESR Max. @ 100kHz (mΩ)	100kHz RMS Current (A)			Endurance at 85°C (hrs)
										25°C	85°C	125°C	
10 Volt @ 85°C													
TCH9337M010W0040#	9	330	10	85	7	125	330	8	40	3.16	2.84	1.26	2000
16 Volt @ 85°C													
TCH9227M016W0040#	9	220	16	85	10	125	352	8	40	3.16	2.84	1.26	10000
25 Volt @ 85°C													
TCH9157M025W0050#	9	150	25	85	17	125	375	8	50	2.83	2.55	1.13	10000
35 Volt @ 85°C													
TCH9107M035W0055#	9	100	35	85	23	125	350	8	55	2.69	2.42	1.08	10000
TCH9157M035W0055#	9	150	35	85	23	125	525	8	55	2.69	2.42	1.08	2000
TCH9157M035WS055C	9	150	35	85	23	125	525	8	55	2.69	2.42	1.08	2000
50 Volt @ 85°C													
TCH9476M050W0070#	9	47	50	85	33	125	235	8	70	2.39	2.15	0.96	10000
TCH9476M050WS070C	9	47	50	85	33	125	235	8	70	2.39	2.15	0.96	10000
75 Volt @ 85°C													
TCH9336M075W0120#	9	33	75	85	50	125	248	8	120	1.82	1.64	0.73	2000
TCH9336M075WS120C	9	33	75	85	50	125	248	8	120	1.82	1.64	0.73	2000
100 Volt @ 85°C													
TCH9226M100W0150#	9	22	100	85	66	125	220	8	150	1.63	1.47	0.65	10000
TCH9226M100WS150C	9	22	100	85	66	125	220	8	150	1.63	1.47	0.65	10000

All technical data relates to an ambient temperature of +25°C. Capacitance and DF are measured at 120Hz, 0.5RMS with a maximum DC bias of 2.2V. DCL is measured at rated voltage after 5 minutes.

Moisture Sensitivity Level (MSL) is defined according to J-STD-020. All TCH products are MSL1.

RECOMMENDED DERATING FACTOR

Voltage and temperature derating as percentage of Vr

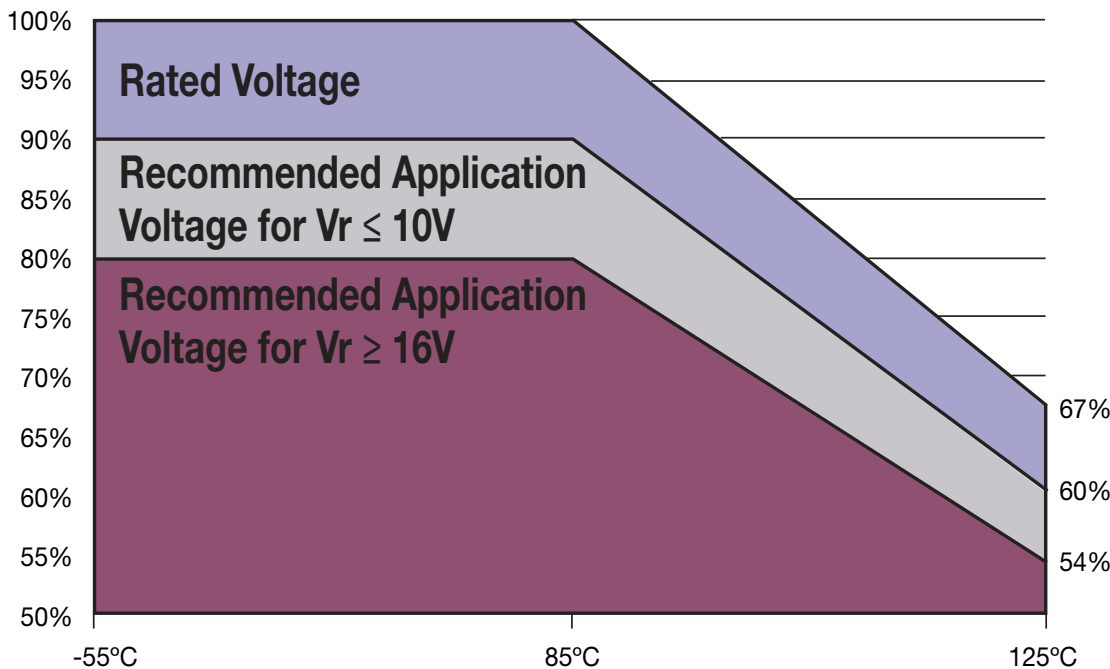

THH 230°C HERMETIC SERIES

SMD 230°C High Temperature Tantalum Capacitor in Hermetic Package, COTS-Plus



FEATURES

- High temperature applications
- Operational condition 230°C / 0.5UR / 1000hrs (2000hrs for selected codes) or 200°C / 0.5UR / 10.000hrs
- 100% surge current tested
- Ceramic case hermetic packaging
- Large case sizes including CTC-21D provide high capacitance values
- Manufacturing and screening utilizing KYOCERA AVX patented Q-Process to effectively remove components that may experience excessive parametric shifts or instability in operation life



APPLICATIONS

- Oil drilling, and Extreme temperature applications

For additional information on Q-process please consult the KYOCERA AVX technical publication:

MARKING

9, I CASE

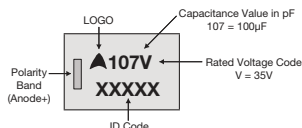

CASE DIMENSIONS: millimeters (inches)

Code	Type	L±0.50 (0.020)	W±0.50 (0.020)	H Max.	W1±0.50 (0.020)	A±0.50 (0.020)	S Min.
9 (CTC-21D)	J-lead (L-shape)	11.50 (0.453)	12.50 (0.492)	6.15 (0.242)	12.50 (0.492)	1.90 (0.075)	7.00 (0.276)
9 (CTC-21D)	J-lead (flex)	12.10 (0.476)	12.50 (0.492)	6.50 (0.256)	12.00 (0.472)	2.00 (0.079)	7.20 (0.283)
9 (CTC-21D)	Undertab	11.00 ± 0.20 (0.433 ± 0.008)	12.50 ± 0.20 (0.492 ± 0.008)	5.95 (0.234)	10.50 ± 0.20 (0.413 ± 0.008)	1.50 ± 0.20 (0.059 ± 0.008)	7.80 (0.307)
I	J-lead (L-shape)	11.50 (0.453)	6.00 (0.236)	2.70 (0.106)	6.00 (0.236)	3.50 (0.138)	4.00 (0.157)
I	J-lead (flex)	11.90 (0.469)	6.00 (0.236)	3.00 (0.118)	5.50 (0.217)	3.60 (0.142)	4.20 (0.165)
I	Undertab	11.00 ± 0.20 (0.433 ± 0.008)	6.00 ± 0.20 (0.236 ± 0.008)	2.50 (0.098)	4.00 ± 0.20 (0.157 ± 0.008)	3.20 ± 0.20 (0.126 ± 0.008)	4.40 (0.173)

'J' Lead Termination (flex)

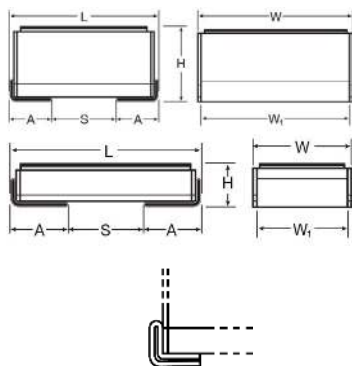

'J' Lead Termination (L-shape)

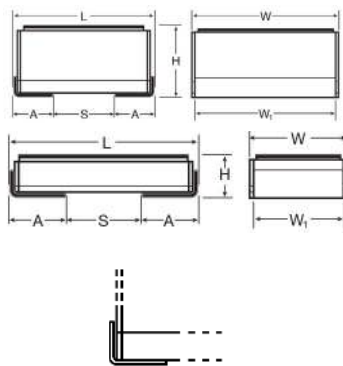

Undertab Termination

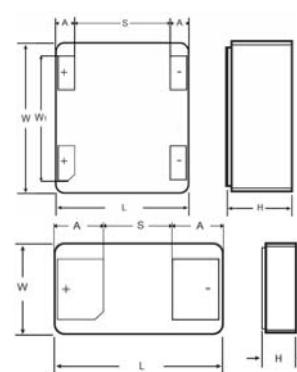

TECHNICAL SPECIFICATIONS

Technical Data:	All technical data relate to an ambient temperature of +25°C			
Capacitance Range:	6.8 µF to 100 µF (for extended range under development, contact manufacturer)			
Capacitance Tolerance:	±20%			
Leakage Current DCL:	0.01CV			
Rated Voltage (V _R)	≤ +85°C:	16	35	50
Category Voltage (V _C)	≤ +230°C:	8	17	25
Temperature Range:	-55°C to +230°C			
Reliability:	1% per 1000 hours at 85°C, Vr with 0.1Ω/V series impedance, 60% confidence level			
Termination Finish:	Gold Plating (Undertab), Gold Plating (J-lead L shape), Nickel Plating (J-lead flex)			

THH 230°C HERMETIC SERIES

SMD 230°C High Temperature Tantalum Capacitor in Hermetic Package, COTS-Plus



HOW TO ORDER

PART NUMBER

THH	9	107	M	035	W	0250	#
Type	Case Size See table above	Capacitance Code pF code: 1st two digits represent significant figures 3rd digit represents multiplier (number of zeros to follow)	Tolerance M = ±20%	Rated DC Voltage 016 = 16Vdc 035 = 35Vdc 050 = 50Vdc	Packaging W = Waffle	ESR in mΩ	Termination J = 'J' lead (L-shape) W = 'J' lead (flex) U = Undertab



CAPACITANCE AND VOLTAGE RANGE (CODE DENOTES THE CASE SIZE)

Capacitance		Rated Voltage DC (V _R) at 85°C		
μF	Code	16V (C)	35V (V)	50V (T)
6.8	685			
10	106			
15	156			
22	226			
33	336			
47	476			
68	686			
100	107		9	

Released ratings

Engineering samples - please contact KYOCERA AVX

VOLTAGE VS TEMPERATURE RATING

Part No.	Case Size	Capacitance (μF)	Rated Voltage @ 85°C (V)	Category Voltage @ 230°C (V)	DCL Max. (μA)	DF Max. (%)	ESR Max. @ 100kHz (mΩ)	100kHz RMS Current (A)			Lifetime at 230°C (hrs)	MSL
								25°C	85°C	125°C		
16 Volt												
THHI226M016W0500#	I	22	16	8	3.6	8	500	0.81	0.73	0.73	2,000	1
THHI476M016W0500#	I	47	16	8	7.5	8	500	0.81	0.73	0.73	1,000	1
35 Volt												
THHI685M035W0500#	I	6.8	35	17	2.4	8	500	0.81	0.73	0.73	2,000	1
THHI106M035W0500#	I	10	35	17	3.5	8	500	0.81	0.73	0.73	2,000	1
THH9107M035W0250#	9	100	35	17	35	8	250	1.26	1.13	1.13	2,000	1
50 Volt												
THHI685M050W0500#	I	6.8	50	25	3.4	8	500	0.81	0.73	0.73	1,000	1

All technical data relates to an ambient temperature of +25°C. Capacitance and DF are measured at 120Hz, 0.5V RMS with a maximum DC bias of 2.2 volts. DCL is measured at rated voltage after 5 minutes.

ESR change post 1000hrs allowed up to 3 times catalog limit.

Moisture Sensitivity Level (MSL) is defined according to J-STD-020.



The Important Information/Disclaimer is incorporated in the catalog where these specifications came from or available online at www.kyocera-avx.com/disclaimer/ by reference and should be reviewed in full before placing any order.

TDS-HIRELTANT-0030 | Rev 1

– HIGH RELIABILITY TANTALUM CAPACITORS –

THH 230°C HERMETIC SERIES

SMD 230°C High Temperature Tantalum Capacitor in Hermetic Package, COTS-Plus



VOLTAGE VS TEMPERATURE RATING

THH 230°C Voltage vs Temperature Rating for 1000 (or 2000) hrs service life

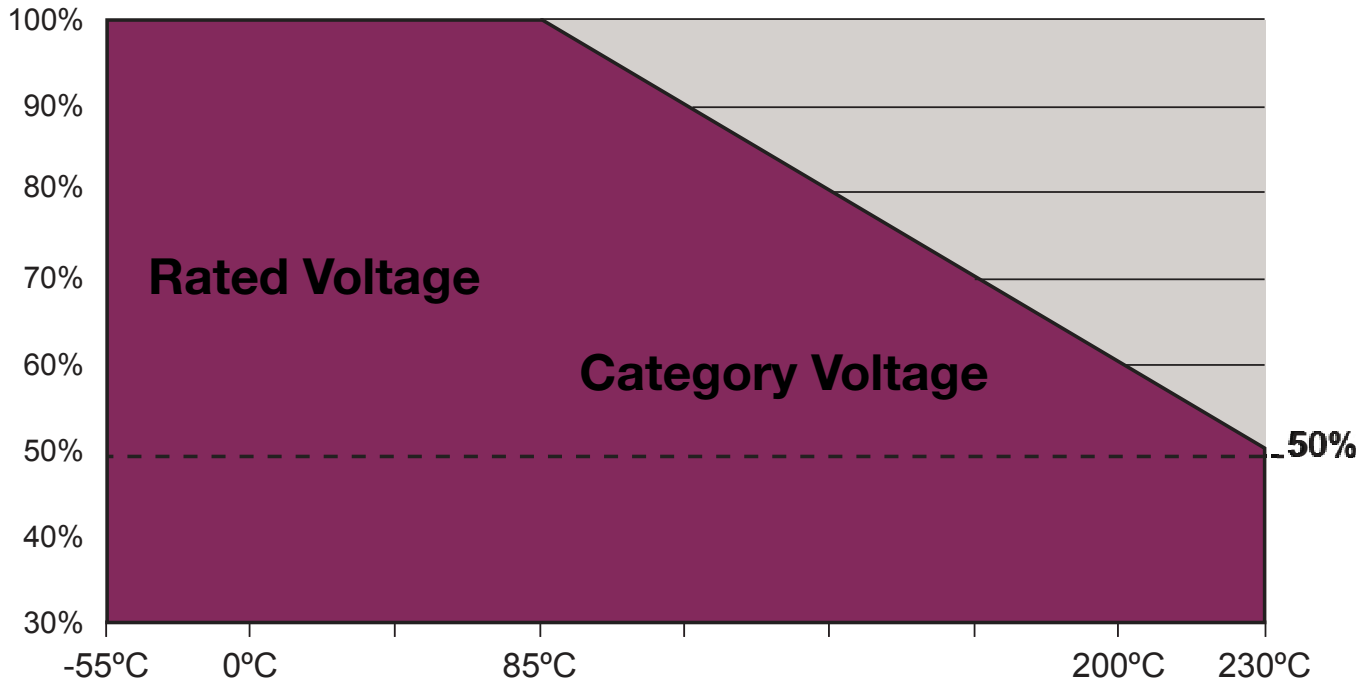

THH 230°C HERMETIC SERIES

SMD 230°C High Temperature Tantalum Capacitor in Hermetic Package, COTS-Plus



QUALIFICATION TABLE

TEST	THH 230°C hermetic series (Temperature range -55°C to +230°C)												
	Condition			Characteristics									
Endurance	Determine after application of 230°C temperature, category voltage for 1000+48/-0 hours or 2000+48/-0hrs and then leaving min. 2 hours at room temperature. Power supply impedance to be <3Ω.			Visual examination	no visible damage								
				DCL	1.25 x initial limit								
				ΔC/C	within ±20% of initial value								
				DF	1.5 x initial limit								
				ESR	3 x initial limit								
Endurance	Determine after application of 0.5UR for 10000+48/-0 hours at 200°C temperature and then leaving min. 2 hours at room temperature. Power supply impedance to be <3Ω.			Visual examination	no visible damage								
				DCL	1.25 x initial limit								
				ΔC/C	within ±20% of initial value								
				DF	1.5 x initial limit								
				ESR	3 x initial limit								
Storage Life	230°C, 0V, 1000h + 48/-0 hours			Visual examination	no visible damage								
				DCL	initial limit								
				ΔC/C	within ±5% of initial value								
				DF	initial limit								
				ESR	1.25 x initial limit								
Biased Humidity	Determine after leaving for 1000 hours at 85±2°C, 85% relative humidity and rated voltage and then recovery min. 2 hours at room temperature.			Visual examination	no visible damage								
				DCL	initial limit								
				ΔC/C	within ±10% of initial value								
				DF	initial limit								
				ESR	1.25 x initial limit								
Temperature Stability	Step	Temperature°C	Duration (min)		+20°C	-55°C	+20°C	+85°C	+125°C	+175°C	+200°C	+230°C	+20°C
	1	+20	15	DCL	IL*	n/a	IL*	10 x IL*	12.5 x IL*	n/a	n/a	n/a	IL*
	2	-55	15	ΔC/C	n/a	+0/-20%	±5%	+20/-0%	+30/-0%	+30/-0%	+30/-0%	+30/-0%	±5%
	3	+20	15	DF	IL*	1.5 x IL*	IL*	1.5 x IL*	2 x IL*	2 x IL*	2 x IL*	2 x IL*	IL*
	4	+85	15	ESR	1.25 x IL*	1.25 x IL*	1.25 x IL*	1.25 x IL*	1.25 x IL*	1.25 x IL*	1.25 x IL*	1.25 x IL*	1.25 x IL*
	5	+125	15										
	6	+175	15										
	7	+200	15										
	8	+230	15										
	9	+20	15										
Surge Voltage	Test temperature: 85°C±3/0°C Surge voltage: 1.3 x rated voltage Series protection resistance: 33Ω Discharge resistance: 33Ω Number of cycles: 1000x Cycle duration: 5 min; 30 sec charge, 5 min 30 sec discharge			Visual examination	no visible damage								
				DCL	initial limit								
				ΔC/C	within ±20% of initial value								
				DF	initial limit								
				ESR	1.25 x initial limit								
Mechanical Shock/Vibration	MIL-STD-202, Method 213, Condition I, 100 G peak MIL-STD-202, Method 204, Condition D, 10 Hz to 2,000 Hz, 20 G peak			Visual examination	no visible damage								
				DCL	initial limit								
				ΔC/C	within ±10% of initial value								
				DF	initial limit								
				ESR	1.25 x initial limit								
Vibration 230°C	Determine after application of 230°C temperature and vibration frequency: 10 ~ 2000 ~ 10Hz in 20 min Full amplitude: 3 mm/20g Vibration directions time X, Y Z directions: 4 hours each direction: total 12 hrs.			Visual examination	no visible damage								
				DCL	initial limit								
				ΔC/C	within ±5% of initial value								
				DF	initial limit								
				ESR	1.25 x initial limit								

*Initial Limit

HIGH RELIABILITY TANTALUM MSL

Storage, Bake out, and Handing Recommendations

KYOCERA AVX Biddeford ships all COTS+, military, space level, and *medical grade surface mount tantalum capacitors in moisture resistant bags as a part of best practice. This includes CWR, TAZ, T4Z, TBJ, TBC, T4C, T4J, TBM, and TCP product. This has improved our service to customers by alleviating the potential for long term exposure to high humidity conditions during shipping and storage.

Biddeford product that is considered to be MSL 3 includes TBMs, TCPs, TCBs, TCDs, TCSs, T4Cs, T4Js, TBJ V, U and E case, TAZ (CWR09/19/29) H, V, and X case and T4Z H case. The remainder of our tantalum capacitors are rated MSL 1 for moisture (per J-STD-020D). KYOCERA AVX MSL 1 Tantalum capacitors are unaffected by storage for 2 years at the following conditions: a temperature between -10°C and +35°C, maximum of 85% RH, and atmospheric pressure between 860 mbar and 1060mbar. Exposure to humidity in excess of the above conditions can occur during shipping or

storage; this may affect the leakage current of resin protected capacitors and possibly result in damaging the capacitors during reflow.

If high exposure occurs, MSL 1 product can be dried by baking at temperatures between 85°C for 16 hours to 125°C for 4 hours. Product packaged in tape and reel requires special handling as the tape and reels cannot withstand these temperatures. Extended bake out at 55°C with less than 10% humidity for 48-hours can be performed for product in tape and reel packaging. MSL 3 product should be baked out for 168 hours at 40°C.

The convection reflow profiles below are recommended to ensure parametric integrity of the capacitors is maintained. An improper combination of temperature and time can lead to damage in the dielectric of the component and this profile minimizes that risk.

RECOMMENDED SN/PB CONVECTION REFLOW PROFILE

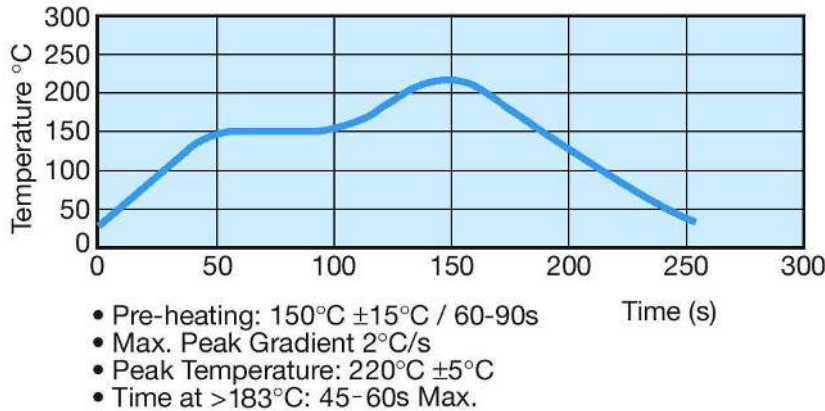

RECOMMENDED LEAD-FREE CONVECTION REFLOW PROFILE

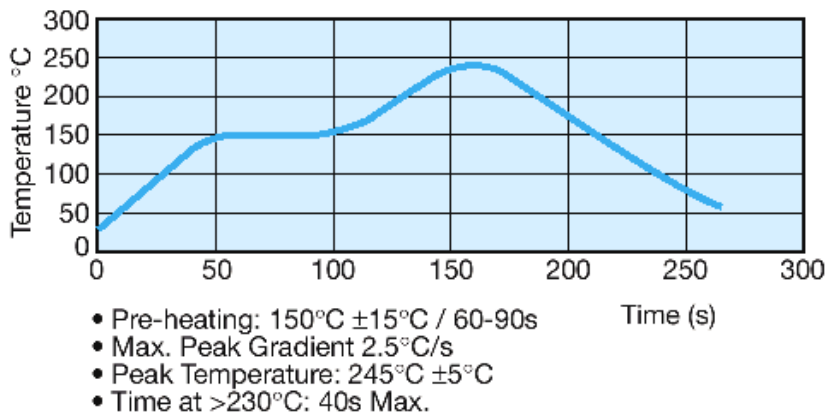

*For implantable medical applications please contact the factory for further recommendations.

TAZ COTS+, CWR09, CWR19, CWR29, TAZ HRC5000 AND T4Z SERIES



Tape & Reel Packaging

Solid Tantalum Chip TAZ Tape and reel packaging for automatic component placement.

Please enter required Suffix on order. Bulk packaging is standard.

TAZ TAPING SUFFIX TABLE

Case Size reference	Tape width mm	P mm	180mm (7") reel		330mm (13") reel	
			Suffix	Qty.	Suffix	Qty.
A	8	4	R	2500	S	9000
R	8	4	R	2500	S	-
B	12	4	R	2500	S	9000
C	12	4	R	2500	S	9000
D	12	4	R	2500	S	8000
E	12	4	R	2500	S	8000
F	12	8	R	1000	S	3000
G	12	8	R	500	S	2500
H	12	8	R	500	S	2500
X	12	8	R	500	S	2000

Total Tape Thickness – K max	
TAZ	
Case size reference	Millimeters (Inches) DIM
A	2.0 (0.079)
R	2.0 (0.079)
B	4.0 (0.157)
D	4.0 (0.157)
E	4.0 (0.157)
F	4.0 (0.157)
G	4.0 (0.157)
H	4.0 (0.157)
X	4.0 (0.157)

Code	8mm Tape		12mm Tape	
P*	4±0.1 or 8±0.1	(0.157±0.004) (0.315±0.004)	4±0.1 or 8±0.1	(0.157±0.004) (0.315±0.004)
G	0.75 min	(0.03 min)	0.75 min	(0.03 min)
F	3.5±0.04	(0.138±0.002)	5.5±0.05	(0.22±0.002)
E	1.75±0.1	(0.069±0.004)	1.75±0.1	(0.069±0.004)
W	8±0.3	(0.315±0.012)	12±0.3	(0.472±0.012)
P ₂	2±0.05	(0.079±0.002)	2±0.05	(0.079±0.002)
P ₀	4±0.1	(0.157±0.004)	4±0.1	(0.157±0.004)
D	1.5±0.1 -0	(0.059±0.004) (-0)	1.5±0.1 -0	(0.059±0.004) (-0)
D ₁	1.0 min	(0.039 min)	1.5 min	(0.059 min)

*See taping suffix tables for actual P dimension (component pitch).

TAPE SPECIFICATION

Tape dimensions comply to EIA RS 481 A

Dimensions A₀ and B₀ of the pocket and the tape thickness, K, are dependent on the component size.

Tape materials do not affect component solderability during storage.

Carrier Tape Thickness <0.4mm

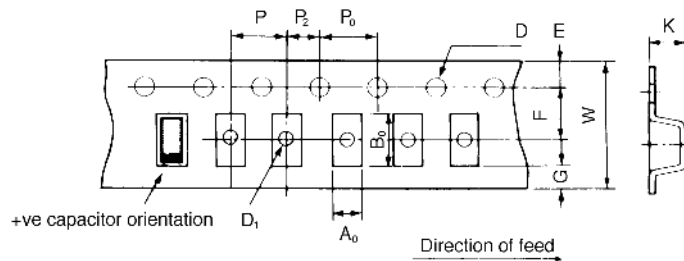

TAJ, TBJ, T4J, TBM, TES, TBC, T4C, TCB, TCD, AND TCS SERIES



Tape & Reel Packaging

Tape and reel packaging for automatic component placement. Please enter required Suffix on order. Bulk packaging is not available.

TAPE SPECIFICATION

Tape dimensions comply to EIA 481-1 Dimensions A0 and B0 of the pocket and the tape thickness, K, are dependent on the component size. Tape materials do not affect component solderability during storage. Carrier Tape Thickness <0.4mm.

TAPING TABLE TAJ ESCC, TAJ CECC, TBJ CWR11, TBJ COTS+, T4J, TBM, TES, TCB, TCD AND TCS SERIES

Case Size	Tape width mm	P mm	180mm (7") reel Qty.	330mm (13") reel Qty.
A	8	4	2,000	8,000
B	8	4	2,000	8,000
C	12	8	500	3,000
D	12	8	500	2,500
E	12	8	400	1,500
U	16	8	400	-
V	12	8	400	1,500

TAPING SUFFIX TABLE TBC CWR15, COTS+, TBC HRC5000, TBC HRC6000 AND T4C SERIES

Case Size	Tape width mm	P mm	100mm (4") reel		180mm (7") reel	
			Designator	Qty.	Designator	Qty.
A	12	4			R	2,000
B	12	8			R	1,000
K	8	2	Q	1,000	P	10,000
L	8	4	X	500	R	3,500
R	8	4	X	500	R	2,500
S	12	4			R	2,000

PLASTIC TAPE DIMENSIONS TAJ ESCC, TAJ CECC, TBJ CWR11, TBJ COTS+, T4J, TBM, TES, TCB, TCD AND TCS SERIES

Case	A0±0.10	B0±0.10	K±0.10	W±0.30	E±0.10	F±0.05	G min.	P±0.10	P2±0.05	P0±0.10	D ^{+0.20} _{-0.00}	D1 ^{+0.25} _{-0.00}
A	1.83	3.57	1.87	8.00	1.75	3.50	0.75	4.00	2.00	4.00	1.50	1.00
B	3.15	3.77	2.22	8.00	1.75	3.50	0.75	4.00	2.00	4.00	1.50	1.00
C	3.45	6.40	2.92	12.00	1.75	5.50	0.75	8.00	2.00	4.00	1.50	1.50
D	4.48	7.62	3.22	12.00	1.75	5.50	0.75	8.00	2.00	4.00	1.50	1.50
E	4.50	7.50	4.50	12.00	1.75	5.50	0.75	8.00	2.00	4.00	1.50	1.50
U	6.19	7.66	4.72	16.00	1.75	7.50	0.75	8.00	2.00	4.00	1.50	1.50
V	6.43	7.44	3.84	12.00	1.75	5.50	0.75	8.00	2.00	4.00	1.50	1.50

PLASTIC TAPE DIMENSIONS TBC CWR15, COTS+, TBC HRC5000, TBC HRC6000 AND T4C SERIES

Case	A0±0.10	B0±0.10	K±0.10	W±0.30	E±0.10	F±0.05	G min.	P±0.10	P2±0.05	P0±0.10	D±0.05
A	1.91	3.53	1.93	12.00	1.75	5.50	0.75	4.00	2.00	4.00	1.55
B	3.30	4.17	2.03	12.00	1.75	5.50	0.75	8.00	2.00	4.00	1.55
K	0.75	1.26	0.67	8.00	1.75	3.50	0.75	2.00	2.00	4.00	1.55
L	1.05	1.90	1.17	8.00	1.75	3.50	0.75	4.00	2.00	4.00	1.55
R	1.65	2.45	1.68	8.00	1.75	3.50	0.75	4.00	2.00	4.00	1.55
S	1.91	3.53	1.93	12.00	1.75	5.50	0.75	4.00	2.00	4.00	1.55

REEL DIMENSIONS

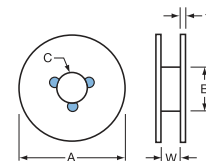
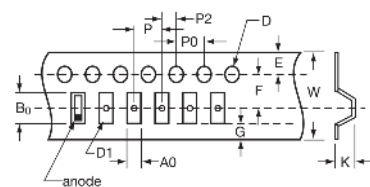

Reel Size	Tape	A	B	C	W	t
180mm (7")	12mm	178±2.00	50 min	13.0±0.50	12.4+1.5/-0	1.50±0.50
180mm (7")	8mm	178±2.00	50 min	13.0±0.50	8.4+1.5/-0	1.50±0.50
330mm (13")	12mm	328±2.00	50 min	13.0±0.50	12.4+1.5/-0	1.50±0.50
330mm (13")	8mm	328±2.00	50 min	13.0±0.50	8.4+1.5/-0	1.50±0.50
108mm (4.25")	8mm	108±2.00		13.0±0.50	8.4+1.5/-0	1.50±0.50

COVER TAPE NOMINAL DIMENSIONS

Thickness: 75µm
Width of tape: 5.5mm (8mm tape)
9.5mm (12mm tape)

TCH AND THH

Packaging

TCH AND THH PACKAGING SPECIFICATION

The dimensions of the tray see in the figure below. Tolerance of dimensions are ± 0.1 mm. Both case size "9" and "I" have 40 pcs per tray.

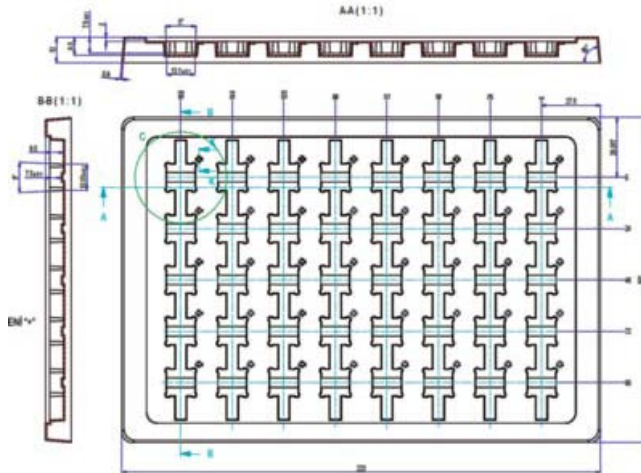

OVERALL CHIP TRAY SIZE

Size	Height	Flatness
50.80mm ± 0.10 mm	3.96mm ^{+0.05mm} / _{-0.08mm}	0.10mm

PLASTIC CHIP TRAY

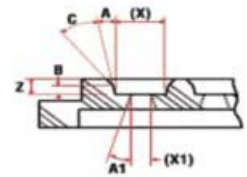
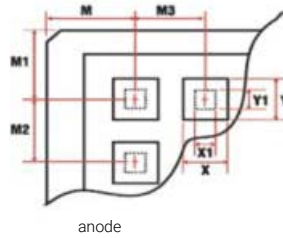

E Case

TANTALUM WET ELECTROLYTIC CAPACITOR

Technical Summary and Application Guidelines

INTRODUCTION

The structure of a Tantalum Wet Electrolytic Capacitor consists of four main elements: a primary electrode (anode), dielectric, a secondary electrode system (cathode) and a wet (liquid) electrolyte. The first, positive electrode (the anode) is a very high surface area structure made of pure tantalum metal. As with anodes prepared for surface mount devices, they are made by pressing and sintering pure tantalum powder together with an embedded tantalum wire (for later electrical contact) into, in this case, a cylindrical pellet of extremely high internal surface area capable of achieving high Capacitance at a given rated voltage. Next, the dielectric, a highly resistive insulating layer, is formed. The dielectric material is a thin film of tantalum pentoxide (Ta_2O_5) created by electrolytic oxidation of the anode surface, a process which grows the film over all of the internal surface area of the anode. The second electrode (cathode) is an extremely high surface area material actually applied to the inside surface of the pure tantalum can that provides the external housing for the device. The cathode system in wet capacitors provides good mechanical robustness and excellent contact with the liquid electrolyte, which is the functional connection between anode and cathode. All are contained within the can which is hermetically sealed, with an external anode lead connected to the embedded anode wire, and an external cathode lead connected to the can.

Wet tantalum capacitors have been utilized for many years in high energy storage applications where volumetric efficiency and

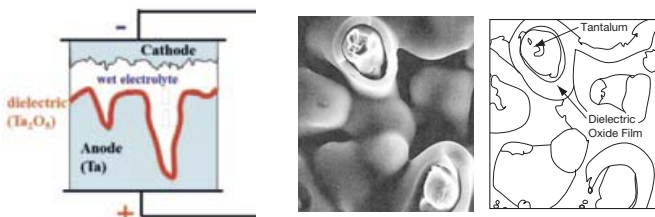

Figure 1 a. Basic Tantalum Wet Electrolytic Capacitor System

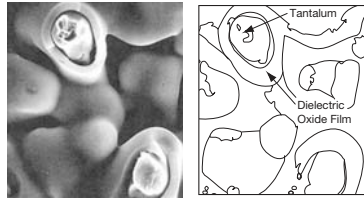

Figure 1 b. Typical Formed anode pellet structure

high reliability are essential requirements. The first wet tantalum capacitors were developed in the middle of 20th century and comprised a tantalum anode surrounded by an electrolyte inside a silver case with an epoxy end seal.

This design was problematic in that it could be prone to leakage of the electrolyte through the epoxy seal. It also had a limited ability to withstand any reverse voltage. The silver case material was later replaced by pure tantalum, which provided more stable performance characteristics over a wide range of applications.

The use of a tantalum case made it easier to construct a tantalum glass-to-metal end-seal that could be laser-welded to the tantalum can, thus making a fully hermetic capacitor. This construction addressed the risk of fluid leakage from the part and improved overall reliability.

The original design also included the use of a porous, high surface area tantalum sleeve inside the case which acted as the cathode system. The design with tantalum sleeve was adopted by MIL-

PRF-39006 and remains the qualified standard tantalum wet capacitors (**TWC series family**).

Because the bulk of the capacitance attainable is strongly dependent on the area of the cathode, alternative cathode systems, directly coated onto the interior of the tantalum can, were developed, such as used by **TWA series family**. This

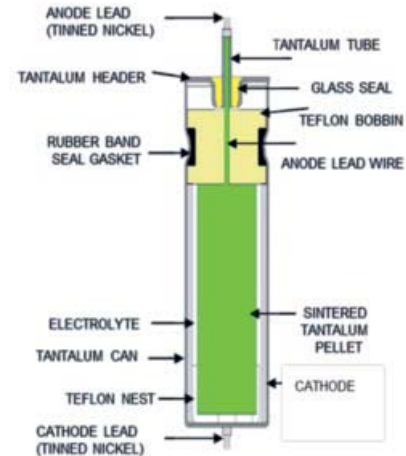

Figure 2. Typical Wet Tantalum Capacitor Construction

system not only increases the overall area of the cathode, but also increases the internal volume available for the anode, thus significantly increasing the potential capacitance/voltage ratings available in each case size. The disadvantage of the alternative cathode system is a limited reverse voltage capability.

The key benefits of wet tantalum electrolyte systems are:

- Large case sizes capable of offering high Capacitance values at high operating voltages.
- Wide operational temperature ranges -55 to 125°C, with special designs up to 230°C
- Wide working voltage range up to 125V
- High volumetric efficiency.

Disadvantages compared to solid tantalum series are:

- Lower electrolyte conductivity resulting in higher ESR.
- Reduced capacitance and increased ESR at low temperatures.
- Risk of hydrogen generation.
- Higher material and manufacturing cost.

Compared to solid tantalum technologies e.g. (MnO_2 or polymer electrolyte), wet tantalum capacitors exhibit a higher surge current capability with a higher breakdown voltage (BDV) close to their dielectric formation voltage. This results in capacitors that require less voltage derating.

Their lower electrolyte conductivity results in a greater capacitance drop with frequency, suiting wet tantalum electrolytic capacitors ideally to high reliability bulk capacitance applications.

TANTALUM WET ELECTROLYTIC CAPACITOR

Technical Summary and Application Guidelines



SECTION 1 ELECTRICAL CHARACTERISTICS AND EXPLANATION OF TERMS

1.1 CAPACITANCE

1.1.1 Rated Capacitance

Capacitance is measured at 120Hz and 25°C with 2.0V DC bias applied. A small reduction in capacitance level (<2%) may be observed at rated voltage.

1.1.2 Capacitance Tolerance

This is the permissible variation of the actual value of the capacitance from the rated value. For additional reading, please consult the KYOCERA AVX technical publication "Capacitance Tolerances for Solid Tantalum Capacitors".

1.1.3 Temperature dependence of capacitance.

The capacitance of a tantalum capacitor varies with temperature. This variation itself is dependent to a small extent on the case size and rating as shown in Figure 1.1.3; capacitance limits for individual ratings at -55°C, +85°C and +125°C are given in the data sheet.

1.1.4 Frequency dependence of capacitance.

Capacitance levels decrease with increasing frequency. Figure 1.1.4a across shows the typical capacitance versus frequency behavior of a TWC series (conventional tantalum sleeve) design. Figure 1.1.4b illustrates typical capacitance characteristics versus frequency for several different ratings of the TWA series (wet system with alternative cathode).

Typical Range of Capacitance Change over Temperature

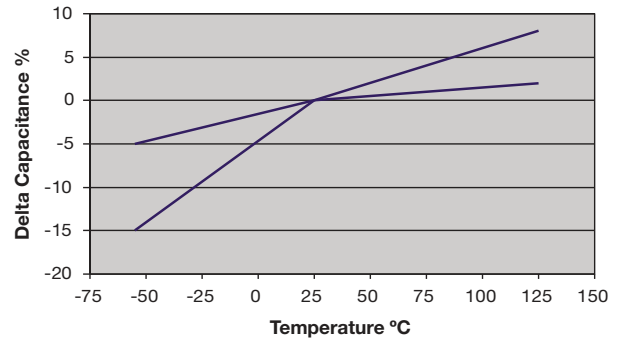

Figure 1.1.3: Typical Capacitance Change Limits vs. Temperature

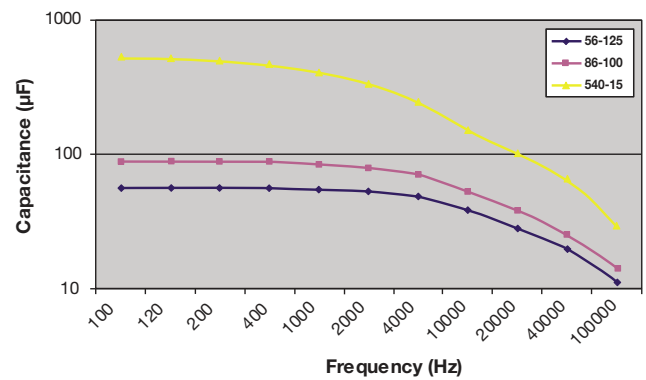

Figure 1.1.4 a: TWC Typical Capacitance vs. Frequency

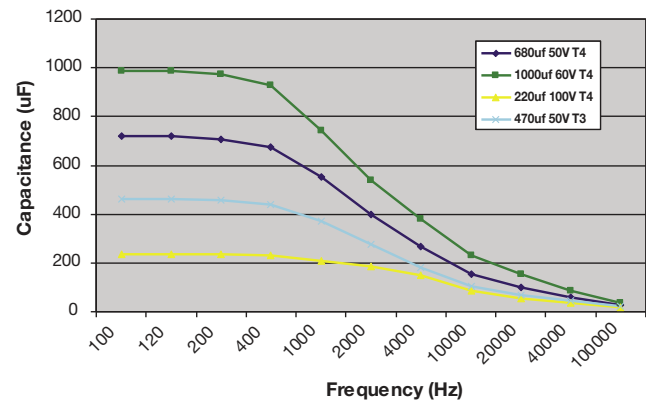

Figure 1.1.4 b: TWA Typical Capacitance vs. Frequency

TANTALUM WET ELECTROLYTIC CAPACITOR

Technical Summary and Application Guidelines

1.2 VOLTAGE

1.2.1 Rated DC Voltage (V_R)

This is the maximum continuous DC voltage that the part may be subjected to at temperatures from -55°C to +85°C.

1.2.2 Category voltage (V_C).

This is the maximum voltage that may be applied continuously to a capacitor over its temperature range. It is equal to the rated voltage V_R from -55°C to +85°C, beyond which it is subject to a linear derating, to 2/3

V_R at 125°C See Figure 1.2.1 below for voltage derating with temperature.

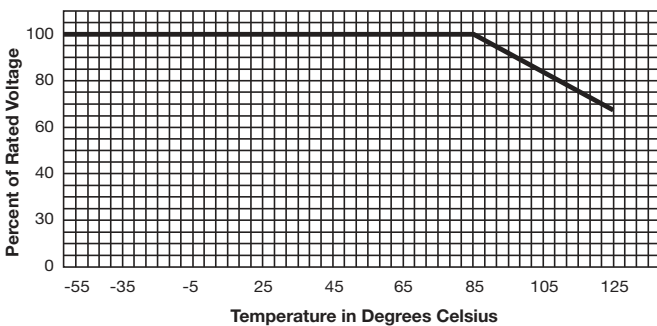

Figure 1.2.1 Voltage Derating over Temperature

The maximum working voltage for temperatures between 85°C and 125°C can also be found from the following formula:

$$V_{max} = \left(1 - \frac{(T - 85)}{125}\right) \times V_R$$

where T is the required operating temperature.

1.2.3 Surge voltage (V_S).

This is the highest voltage that may be applied to a capacitor for short periods of time in circuits with minimum series resistance of 330ohms. This includes the peak AC ripple voltage in addition to the DC bias voltage.

Table 1.2.3 below illustrates the maximum allowable surge voltage for each voltage rating.

Voltage	
Rated (85°C) (85°C)	Surge (85°C) (85°C)
6	6.9
8	9.2
10	11.5
15	17.3
25	28.8
30	34.5
50	57.5
60	69.0
75	86.3
100	115.0
125	144.0

Table 1.2.3 85°C Surge Voltage ratings

TWC Series Family Surge Test:

Typical surge voltage testing consists of 1000 cycles of an applied 30 second surge voltage followed by a 5.5 minute discharge period. Voltage application is made through a resistance of (1,000 ±100) ohms in series with the capacitor. Each surge voltage cycle is performed in such a manner that the capacitor is discharged through a 1 kOhm resistor at the end of 30 seconds of applied voltage. Upon completing the test, the capacitors are allowed to stabilize at room temperature and measured to the following limits:

1. Capacitance shall be within the initial 25°C tolerance
2. DC leakage shall not exceed the initial 25°C limit
3. DF shall not exceed the initial 25°C limit
4. Capacitors shall be visually examined for mechanical damage and leakage of electrolyte.

TWA Series Family Surge Test:

The surge voltage may be applied up to 10 times in an hour for periods of up to 30 seconds at a time. The surge voltage must not be used as the design parameter for circuits in which, in the normal course of operation, the capacitor is periodically charged and discharged to.

1.2.4 High Temperature Voltage (V_T)

High temperature capacitor series (TWA-Y and TWC-Y) (designed for operation above 125°C) can be operated at 60% of their rated DC voltage (V_R) at 200°C for a period specified in their individual data sheets. The specialty high temperature TWA-X series is designed to service at extremes 200-230°C. For maximum operating voltage and time at the temperature see the TWA-X series specification.

1.2.5 Reverse voltage and Non-Polar operation.

Tantalum wet capacitors are inherently polar devices with the positive terminal identified on the body of the component. It is advisable to avoid the application of reverse voltage at all times. However, they do have the capability to withstand some reverse voltage as follows:

TWC Series Family Reverse Voltage Operation

TWC series allow limited reverse voltage levels of up to 3V for a maximum of 125 Hours. Capacitors evaluated to these conditions have met the following requirements:

1. DCL shall not exceed 125% of the initial value specified.
2. Capacitance shall remain within the initial tolerance (5%, 10%, 20%).
3. DF shall not exceed the initial limit specified.

TWA Series Family Reverse Voltage Operation

Continuous application of reverse voltage without normal polarization may result in an increase in leakage current.

Reverse voltage ratings are designed to cover exceptional conditions where small level excursions into incorrect polarity may occur. The values quoted do not apply to continuous reverse operation.

TANTALUM WET ELECTROLYTIC CAPACITOR

Technical Summary and Application Guidelines

Any peak reverse voltage applied to the capacitor must meet the following criteria:

- The peak reverse voltage must be less than or equal to 1.5 volts and the product of the peak current times the duration of the reverse transient must be less than or equal to 0.05 ampere-second.
- The repetition rate of the reverse voltage surges must be less than 10 Hz.

Non-Polar Operation

Under conditions where the continuous application of a reverse voltage could occur, two similar capacitors should be used in a back-to-back configuration with the negative terminations having a common connection. This combination will give a total capacitance of approximately one half of the nominal capacitance of each capacitor. Under conditions of isolated pulses or during the first few cycles, the capacitance may approach the full nominal value.

1.2.6 Superimposed A.C. Voltage (Vrms) - Ripple Voltage.

This is the maximum rms alternating voltage, superimposed on a DC voltage, that may be applied to a capacitor.

The sum of the DC voltage and peak value of the superimposed ac voltage must not exceed the category voltage, V_C .

1.3 IMPEDANCE, (Z) AND EQUIVALENT SERIES RESISTANCE (ESR)

1.3.1 Impedance, Z.

This is the ratio of voltage to current at a specified frequency. The impedance is measured at -55°C and 120Hz.

1.3.2 Equivalent Series Resistance, ESR.

The ESR of a wet tantalum behaves much the same as a solid tantalum capacitor. It will decrease as frequency increases and generally resonance is achieved above 100 kHz. ESR is measured at 120Hz and 25°C with 2.0V DC bias applied. The ESR is frequency dependent and can be found by using the relationship: Where f is the frequency in Hz, and C is the capacitance in farads.

$$ESR = \tan \delta / 2\pi f C$$

ESR is one of the contributing factors to impedance, and at high frequencies (10kHz and above) it becomes the dominant factor.

1.3.3 Frequency dependence of ESR.

ESR and Impedance both reduce with increasing frequency. At

lower frequencies the values diverge as the extra contributions to impedance (due to the reactance of the capacitor) become more significant. In the range (1–10) kHz the values of impedance and ESR are almost identical, while at higher frequencies (and beyond the resonant point of the capacitor) impedance again increases due to the inductance of the capacitor.

1.3.4 Temperature dependence of Impedance, Z and ESR.

ESR and impedance vary with temperature, with the most significant changes occurring at low temperature. ESR and

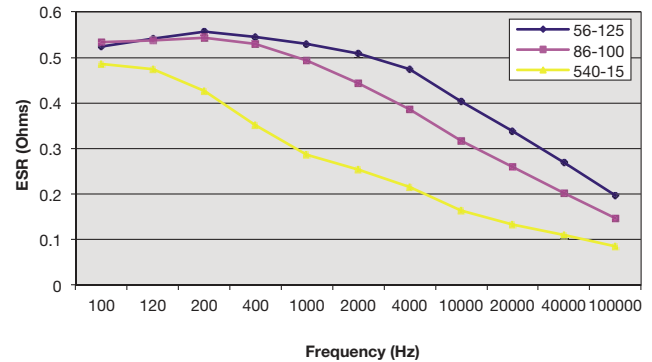

Graph 1.3.3.a TWC Frequency Dependence of ESR

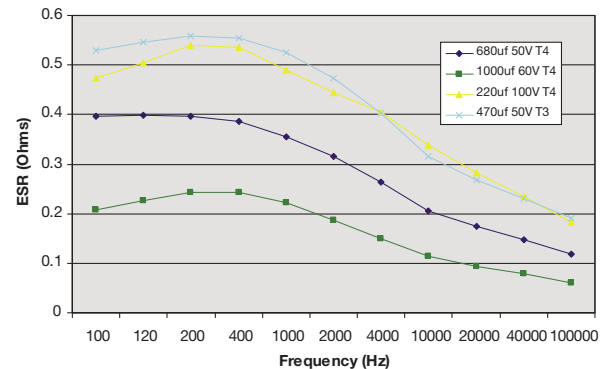

Graph 1.3.3. b TWA Frequency Dependence of ESR

Impedance can increase by a factor of 20 to 30 times at the lower limit of -55°C; low temperature impedance limits for each rating are given in the individual data sheets.

At High temperatures ESR levels reduce slightly. ESR is typically halved at +85°C and is reduced to almost a third at +125°C.

TANTALUM WET ELECTROLYTIC CAPACITOR

Technical Summary and Application Guidelines

1.4 D.C. LEAKAGE CURRENT

1.4.1 Leakage current, DCL.

The leakage current is dependent on the voltage applied, the time over which the voltage is applied and the component temperature. It is measured at +25°C with rated voltage applied. A protective resistance of 1000Ω is connected in series with the capacitor in the measuring circuit. Three to five minutes after application of the rated voltage the leakage current must not exceed the maximum values indicated in the individual data sheet.

Leakage limits are specified for 25°C and 85°C with rated voltage applied, and for 125°C with category (2/3 rated) voltage applied.

Wet tantalum technology is characterized by extremely low leakage current, typically less than 0.0002CV (about 50 times lower than solid tantalum technology).

1.4.2 Temperature Dependence of Leakage current.

Leakage current increases with increasing temperature. In general, there will be a 10 to 12 times increase at 85°C and 125°C respectively. DCL limits for individual ratings at -55°C, +85°C and +125°C are given in the data sheet.

1.4.3 Voltage dependence of the leakage current.

When operated at applied voltages less than the rated voltage, leakage current will be greatly reduced.

When operated at applied voltages less than the rated voltage, reliability in any given application will be increased.

1.5 A.C. OPERATION, POWER DISSIPATION AND RIPPLE CURRENT

1.5.1 A.C. Operation.

In an A.C. application heat is generated within the capacitor primarily by the a.c. component of the signal (which will depend upon the signal form, amplitude and frequency), and secondarily by the DC leakage (for most practical purposes this, second factor is insignificant). The actual power dissipated in the capacitor can be calculated using the formula:

$$P = I^2R$$

rearranged to:

$$I = \text{SQRT}(P/R) \dots (\text{Eq. 1})$$

Where: I = rms ripple current, amperes
 R = equivalent series resistance, ohms
 U = rms ripple voltage, volts
 P = power dissipated, watts
 Z = impedance, ohms, at the frequency under consideration.

The maximum a.c. ripple voltage (U_{max}) is calculated from Ohms' law:

$$U_{\text{max}} = IR \dots (\text{Eq. 2})$$

Where P is the maximum specified permissible power dissipation.

However care must be taken to ensure that:

1. The DC working voltage of the capacitor must not be exceeded by the sum of the positive peak of the applied a.c. voltage and the DC bias voltage.
2. The sum of the applied DC bias voltage and the negative a.c. voltage peak must not exceed the reverse voltage specification limit.

1.5.2 Power Dissipation

Power dissipation is a measure of the power required to heat the capacitor to a certain temperature above ambient. Power dissipation is a function of case size and This is used in the above equations to calculate ripple current limits.

1.5.3 Ripple Current.

Ripple current is referenced at 40kHz at 2/3 rated voltage at 85°C and multipliers for applied voltages of different percentages of rated voltage, and for different frequencies, have been calculated over the temperature range from -55°C to 125°C. These are shown in table 1.5.3.

The reference point (40kHz at 2/3 rated voltage at 85°C) is highlighted in yellow in the table.

Frequency of applied ripple current		120Hz				800Hz				1kHz			
		≤55	85	105	125	≤55	85	105	125	≤55	85	105	125
% of 85°C Rated Peak Voltage	Ambient still air temperature (°C)	≤55	85	105	125	≤55	85	105	125	≤55	85	105	125
	100%	0.60	0.39	-	-	0.71	0.43	-	-	0.72	0.45	-	-
	90%	0.60	0.46	-	-	0.71	0.55	-	-	0.72	0.55	-	-
	80%	0.60	0.52	0.35	-	0.71	0.62	0.42	-	0.72	0.62	0.42	-
	70%	0.60	0.58	0.44	-	0.71	0.69	0.52	-	0.72	0.70	0.52	-
66-2/3%	0.60	0.60	0.46	0.27	0.71	0.71	0.55	0.32	0.72	0.72	0.55	0.32	
Frequency of applied ripple current		10 kHz				40 kHz				100 kHz			
Ambient still air temperature (°C)		≤55	85	105	125	≤55	85	105	125	≤55	85	105	125
% of 85°C rated peak voltage	100%	0.88	0.55	-	-	1	0.63	-	-	1.1	0.69	-	-
	90%	0.88	0.67	-	-	1	0.77	-	-	1.1	0.85	-	-
	80%	0.88	0.76	0.52	-	1	0.87	0.59	-	1.1	0.96	0.65	-
	70%	0.88	0.85	0.64	-	1	0.97	0.73	-	1.1	1.07	0.8	-
	66-2/3%	0.88	0.88	0.68	0.4	1	1	0.77	0.45	1.1	1.1	0.85	0.5

Fig. 1.5.3 Ripple current multipliers vs. Frequency, temperature and applied voltage

1.6 SOLDERING CONDITIONS AND BOARD ATTACHMENT

1.6.1 Wave Soldering.

KYOCERA AVX leaded tantalum capacitors are designed for printed circuit board (pcb) attachment via a wave soldering operation. The soldering temperature and time should be the minimum required for a good connection. After insertion into the pcb, the exposed leads can be passed through wave solder, a suitable temperature/time combination being 230°C – 250°C for 3-5 seconds. Figure 1.7.1 illustrates the allowable range of peak temperature versus time for wave soldering.

TANTALUM WET ELECTROLYTIC CAPACITOR

Technical Summary and Application Guidelines

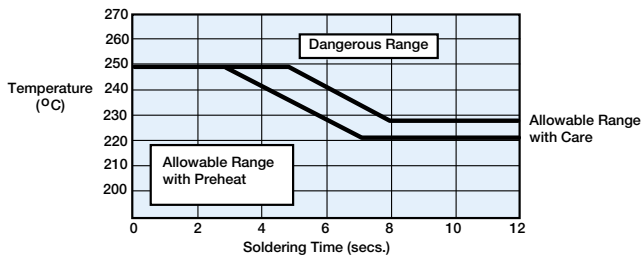

Graph 1.6.1. Allowable range of peak temp./time combinations for wave soldering

As small parametric shifts may be noted immediately after wave solder, components should be allowed to stabilize at room temperature prior to electrical testing. After soldering, the assembly should be allowed to cool naturally. In the event that assisted cooling is used, the rate of change in temperature should not exceed that used in reflow. A recommended wave solder profile is shown below:

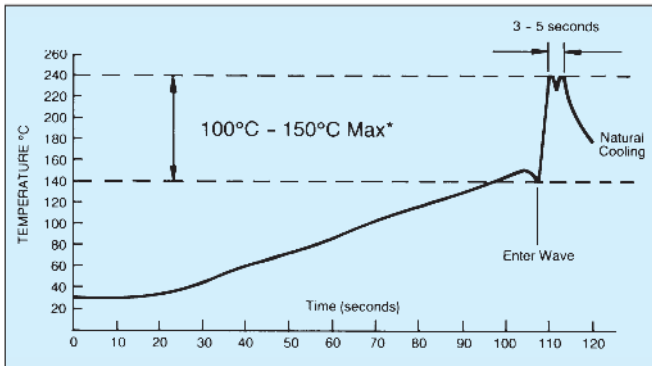

Graph 1.6.2. Recommended Wave Solder Profile

1.7 RELIABILITY CALCULATION

The predicted reliability of a wet tantalum capacitor in an application can be calculated using the equation defined in MIL-HDBK-217 as seen below:

$$\lambda_p = \lambda_b \times \pi_T \times \pi_C \times \pi_V \times \pi_{SR} \times \pi_Q \times \pi_E$$

Failures/10⁶ Hours

where:

- λ_p = part failure rate
- λ_b = base failure rate
- π = factors that modify the base failure rate

For wet tantalum capacitors the base failure rate (λ_b) is:

$$\lambda_b = 0.0004$$

The π factors should be determined from the tables that follow which outline the values for each variable as they pertain to individual components and the applications in which they are utilized.

Temperature Factor π_T		Capacitance Factor π_C		Voltage Stress Factor π_V		Quality Factor π_Q	
T (°C)	π_T	Cap (μF)	* π_C	Voltage Stress	* π_V	Quality	π_Q
20	0.91	1	1.00	0.1	1	D	0.001
30	1.1	4	1.38	0.2	1	C	0.01
40	1.3	10	1.70	0.3	1	S, B	0.03
50	1.6	15	1.86	0.4	1	R	0.1
60	1.8	33	2.23	0.5	1	P	0.3
70	2.2	68	2.64	0.6	2	M	1
80	2.5	100	2.88	0.7	15	L	1.5
90	2.8	220	3.46	0.8	130	COTS-Plus	3
100	3.2	470	4.12	0.9	990	Commercial	10
110	3.7	680	4.48	1	5900		
120	4.1	1200	5.11				
130	4.6	2200	5.87				

* $\pi_C = C/0.23$

Environmental Factor π_E			Series Resistance Factor π_{SR}	
Environmental	π_E Symbol	π_E	Circuit Resistance (Ohms/Volt)	π_{SR}
Ground, Benign	G_B	1	> 0.8	0.66
Ground, Fixed	G_F	10	> 0.6 to 0.8	1
Ground, Mobile	G_M	20	> 0.4 to 0.6	1.3
Naval, Sheltered	N_S	7	> 0.2 to 0.4	2
Naval, Unsheltered	N_U	15	> 0.1 to 0.2	2.7
Airborne, Inhabited Cargo	A_{IC}	12	0 to 0.1	3.3
Airborne, Inhabited Fighter	A_{IF}	15		
Airborne, Uninhabited Cargo	A_{UC}	25		
Airborne, Uninhabited Fighter	A_{UF}	30		
Airborne, Rotary Winged	A_{RW}	40		
Space, Flight	S_F	0.5		
Missile, Flight	M_F	20		
Missile, Launch	M_L	50		
Cannon, Launch	C_L	570		

More information for the definitions of the application environments can be seen in MIL-HDBK-217.

Example Calculation: A 100 VDC 220μF COTS-Plus wet tantalum is being used in a fixed ground environment at 50°C with 60V applied and a series resistance of 0.2 Ohms/Volt.

$$\begin{aligned} \pi_T &= 1.6 & \pi_C &= 3.46 \\ \pi_V &= 2 & \pi_{SR} &= 2 \\ \pi_Q &= 3 & \pi_E &= 10 \end{aligned}$$

$$\lambda_p = 0.0004 \times 1.6 \times 3.46 \times 2 \times 2 \times 3 \times 10 = 0.26 \text{ Failures/10}^6 \text{ Hours}$$

1.8 LONG TERM STORAGE

Higher temperature long term storage of completed circuit card assemblies with capacitors installed can result in an increase in direct current leakage (DCL). This will return to a normal level after a period of electrification. This may also occur during low temperature storage over an extended time period (typically several years). It is recommended that after such a storage period, capacitors should be powered by a soft start / slow voltage ramp to avoid damage to parts with elevated leakage current. For such long term storage, it is recommended that capacitors are kept in environment below +40°C and powered every 2 years to keep the DCL at very low level for their entire life time.



FOLLOW US:     

VISIT US AT WWW.KYOCERA-AVX.COM 

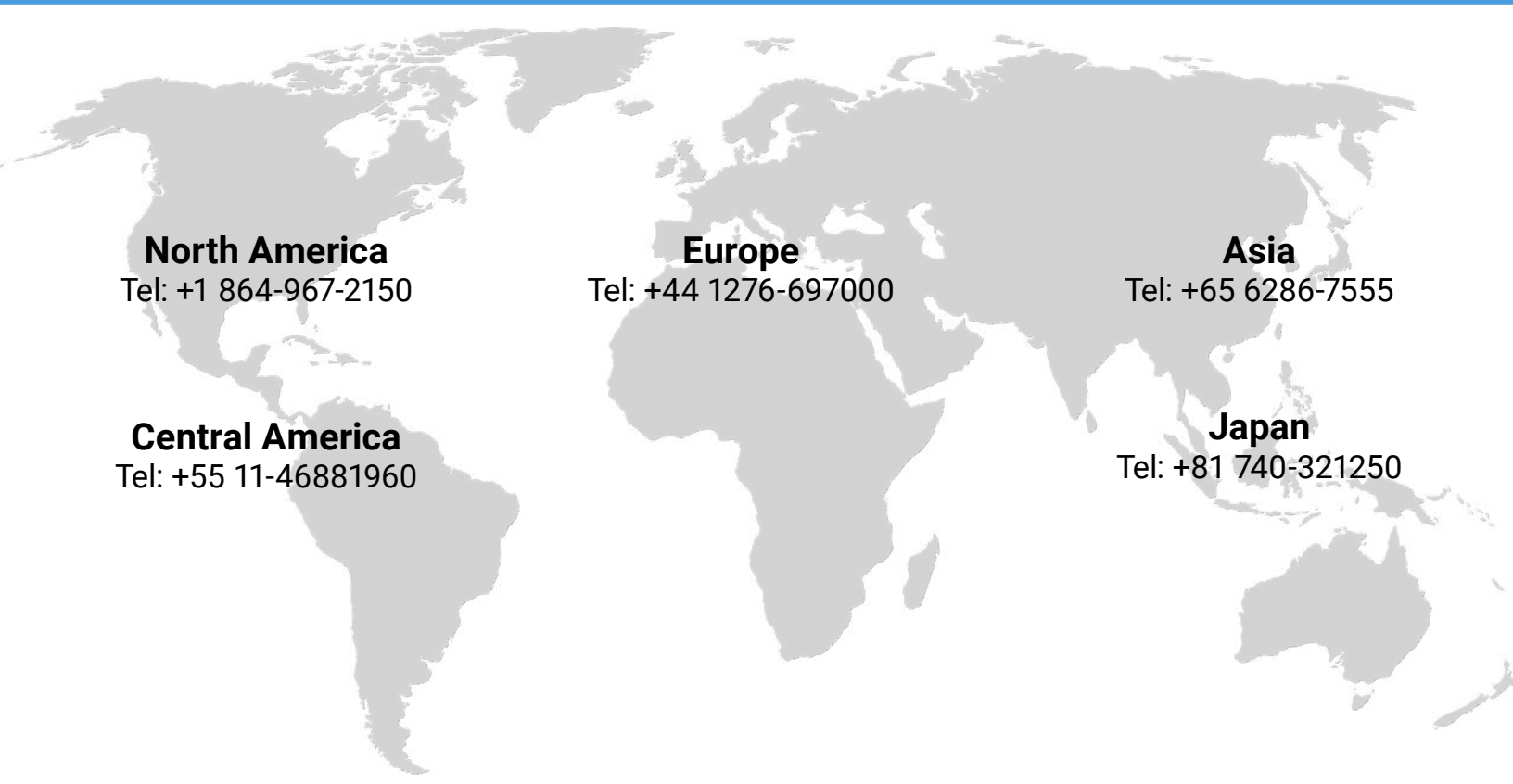

North America

Tel: +1 864-967-2150

Europe

Tel: +44 1276-697000

Asia

Tel: +65 6286-7555

Central America

Tel: +55 11-46881960

Japan

Tel: +81 740-321250