

PFR5331J63J11L4BULK

Aliases (F411JH331J063C)

PFR/F411, Film, Film/Foil Polypropylene, General Purpose, 330 pF, 5%, 63 VDC, 85°C, Lead Spacing = 5mm

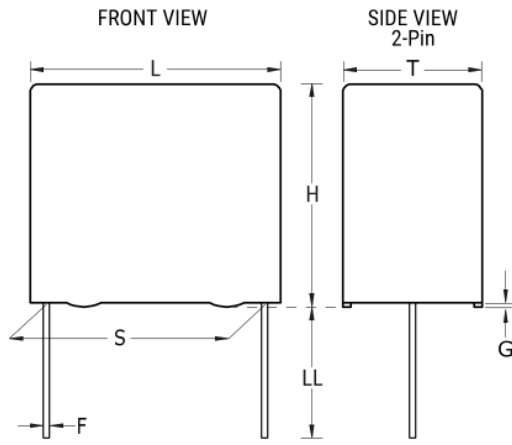

Click [here](#) for the 3D model.

Dimensions	
L	7.2mm -0.5mm
H	6mm -0.5mm
T	4.5mm -0.5mm
S	5mm -0.4mm
LL	4mm +1mm
F	0.5mm +/-0.05mm
G	0.5mm NOM

Packaging Specifications	
Packaging	Bulk, Bag
Packaging Quantity	1000

General Information	
Series	PFR/F411
Dielectric	Film/Foil Polypropylene
Style	Radial
Features	Pulse
RoHS	Yes
Lead	Wire Leads
AEC-Q200	No
Component Weight	0.37 g
Miscellaneous	An Operating Temperature Up To +105C Is Allowed Under Certain Conditions. Please Consult KEMET For Details.

Specifications	
Capacitance	330 pF
Capacitance Tolerance	5%
Voltage AC	40 VAC
Voltage DC	63 VDC
Temperature Range	-55/+100°C
Rated Temperature	85°C
Dissipation Factor	0.04% 1kHz, 0.04% 10kHz, 0.05% 100kHz
Insulation Resistance	100 GOhms
Max dV/dt	1000 V/us
Inductance	6 nH

Statements of suitability for certain applications are based on our knowledge of typical operating conditions for such applications, but are not intended to constitute - and we specifically disclaim - any warranty concerning suitability for a specific customer application or use. This information is intended for use only by customers who have the requisite experience and capability to determine the correct products for their application. Any technical advice inferred from this information or otherwise provided by us with reference to the use of our products is given gratis, and we assume no obligation or liability for the advice given or results obtained.