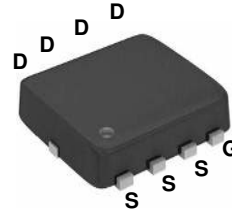
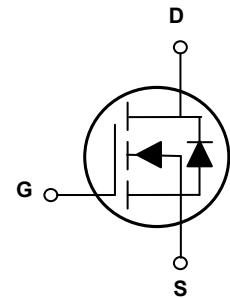


## Main Product Characteristics

$BV_{DSS}$	30V
$R_{DS(ON)}$	7.9m $\Omega$
$I_D$	45A



PPAK 3x3



Schematic Diagram

## Features and Benefits

- Advanced MOSFET process technology
- Ideal for high efficiency switched mode power supplies
- Low on-resistance with low gate charge
- Fast switching and reverse body recovery



## Description

The GSFP3944 utilizes the latest techniques to achieve high cell density and low on-resistance. These features make this device extremely efficient and reliable for use in high efficiency switch mode power supply and a wide variety of other applications.

## Absolute Maximum Ratings ( $T_C=25^\circ\text{C}$ unless otherwise specified)

Parameter	Symbol	Max.	Unit
Drain-Source Voltage	$V_{DS}$	30	V
Gate-Source Voltage	$V_{GS}$	$\pm 20$	V
Drain Current-Continuous ( $T_C=25^\circ\text{C}$ )	$I_D$	45	A
Drain Current-Continuous ( $T_C=100^\circ\text{C}$ )		28.5	
Drain Current-Pulsed <sup>1</sup>	$I_{DM}$	180	A
Single Pulse Avalanche Energy <sup>2</sup>	$E_{AS}$	45	mJ
Single Pulse Avalanche Current <sup>2</sup>	$I_{AS}$	30	A
Power Dissipation ( $T_C=25^\circ\text{C}$ )	$P_D$	30	W
Power Dissipation-Derate above $25^\circ\text{C}$		0.24	
Thermal Resistance, Junction-to-Ambient	$R_{\theta JA}$	62	$^\circ\text{C}/\text{W}$
Thermal Resistance, Junction-to-Case	$R_{\theta JC}$	4.15	$^\circ\text{C}/\text{W}$
Operating Junction Temperature Range	$T_J$	-55 To +150	$^\circ\text{C}$
Storage Temperature Range	$T_{STG}$	-55 To +150	$^\circ\text{C}$

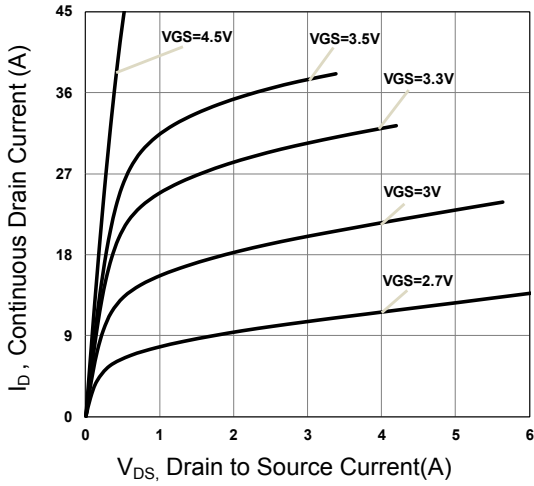
**Electrical Characteristics** ( $T_J=25^{\circ}\text{C}$  unless otherwise specified)

Parameter	Symbol	Conditions	Min.	Typ.	Max.	Unit
<b>On/Off Characteristics</b>						
Drain-Source Breakdown Voltage	$BV_{DSS}$	$V_{GS}=0V, I_D=250\mu A$	30	-	-	V
Drain-Source Leakage Current	$I_{DSS}$	$V_{DS}=30V, V_{GS}=0V, T_J=25^{\circ}\text{C}$	-	-	1	$\mu A$
		$V_{DS}=24V, V_{GS}=0V, T_J=125^{\circ}\text{C}$	-	-	10	$\mu A$
Gate-Source Leakage Current	$I_{GSS}$	$V_{GS}=\pm 20V, V_{DS}=0V$	-	-	$\pm 100$	nA
Static Drain-Source On-Resistance	$R_{DS(ON)}$	$V_{GS}=10V, I_D=15A$	-	6.6	7.9	m $\Omega$
		$V_{GS}=4.5V, I_D=10A$	-	9.2	12	
Gate Threshold Voltage	$V_{GS(th)}$	$V_{GS}=V_{DS}, I_D=250\mu A$	1.2	1.6	2.5	V
Forward Transconductance	$g_{fs}$	$V_{DS}=10V, I_D=3A$	-	20	-	S
<b>Dynamic and Switching Characteristics</b>						
Total Gate Charge <sup>3,4</sup>	$Q_g$	$V_{DS}=15V, I_D=25A, V_{GS}=10V$	-	15	23	nC
Gate-Source Charge <sup>3,4</sup>	$Q_{gs}$		-	1.8	3	
Gate-Drain Charge <sup>3,4</sup>	$Q_{gd}$		-	4	6	
Turn-On Delay Time <sup>3,4</sup>	$t_{d(on)}$	$V_{DD}=15V, R_G=6\Omega, V_{GS}=10V, I_D=25A$	-	5	7.5	nS
Rise Time <sup>3,4</sup>	$t_r$		-	13	20	
Turn-Off Delay Time <sup>3,4</sup>	$t_{d(off)}$		-	28	42	
Fall Time <sup>3,4</sup>	$t_f$		-	8	12	
Input Capacitance	$C_{iss}$	$V_{DS}=15V, V_{GS}=0V, F=1\text{MHz}$	-	900	1350	pF
Output Capacitance	$C_{oss}$		-	130	200	
Reverse Transfer Capacitance	$C_{rss}$		-	110	170	
Gate Resistance	$R_g$	$V_{GS}=0V, V_{DS}=0V, F=1\text{MHz}$	-	2	-	$\Omega$
<b>Drain-Source Diode Characteristics and Maximum Ratings</b>						
Continuous Source Current	$I_S$	$V_G=V_D=0V, \text{Force Current}$	-	-	45	A
Pulsed Source Current	$I_{SM}$		-	-	90	A
Diode Forward Voltage	$V_{SD}$	$V_{GS}=0V, I_S=1A, T_J=25^{\circ}\text{C}$	-	-	1	V

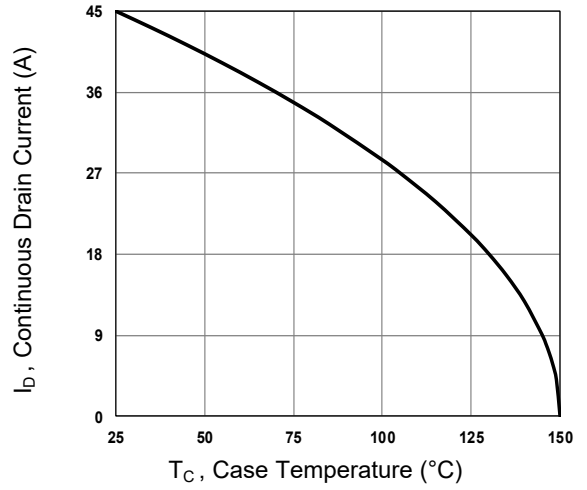
Note:

1. Repetitive rating: Pulsed width limited by maximum junction temperature.
2.  $V_{DD}=25V, V_{GS}=10V, L=0.1\text{mH}, I_{AS}=30A, R_G=25\Omega, \text{starting } T_J=25^{\circ}\text{C}$ .
3. Pulse test: pulse width  $\leq 300\mu s, \text{duty cycle} \leq 2\%$ .
4. Essentially independent of operating temperature.

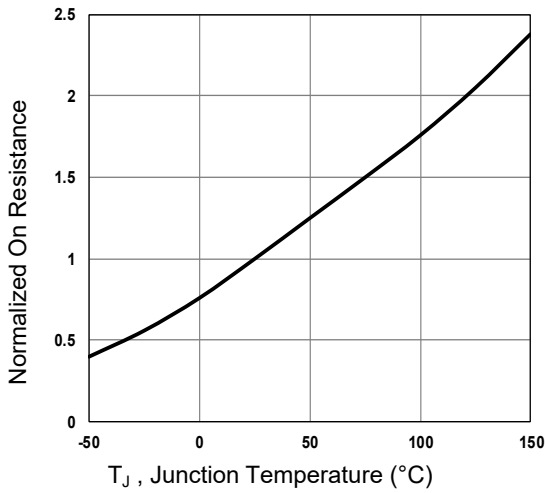
**Typical Electrical and Thermal Characteristic Curves**



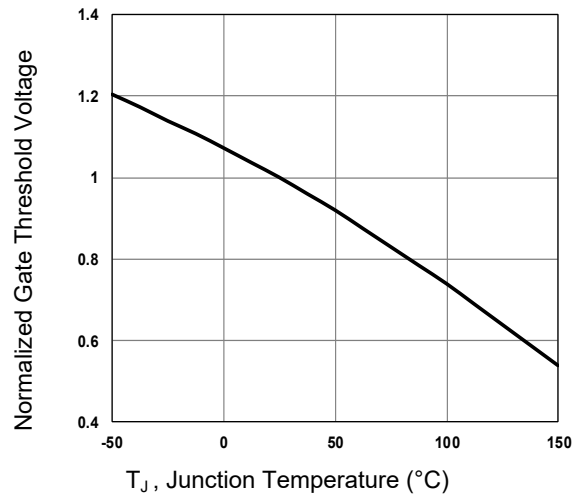
**Figure 1. Typical Output Characteristics**



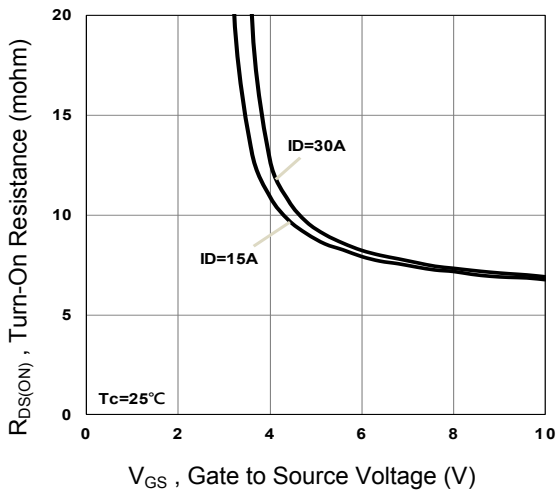
**Figure 2. Continuous Drain Current vs.  $T_C$**



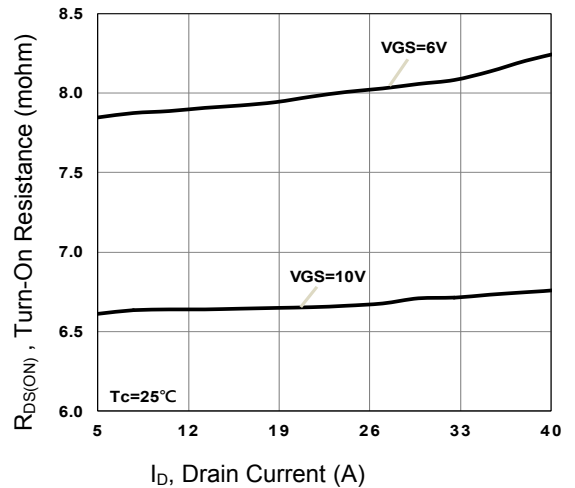
**Figure 3. Normalized  $R_{DS(on)}$  vs.  $T_J$**



**Figure 4. Normalized  $V_{th}$  vs.  $T_J$**

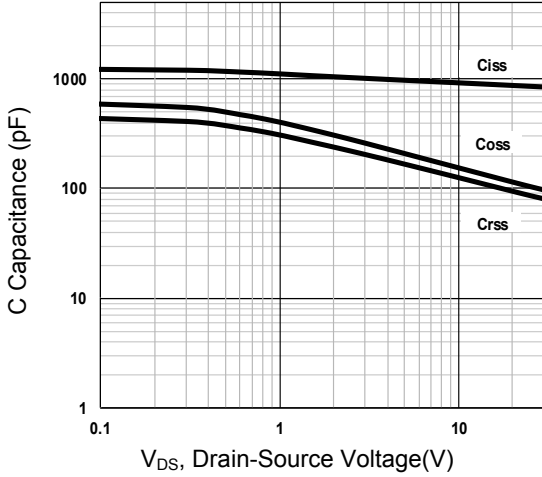


**Figure 5. Turn-On Resistance vs.  $V_{GS}$**

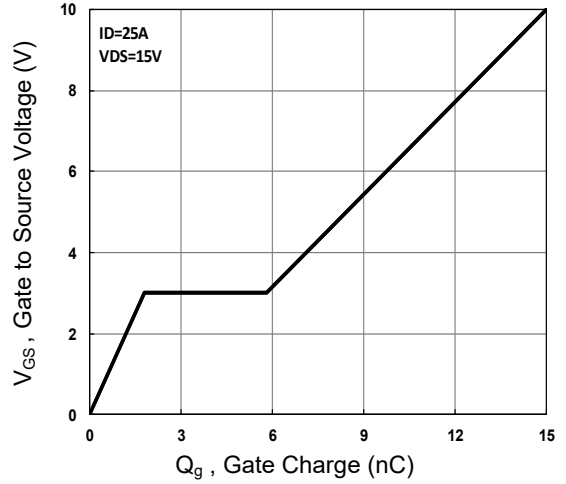


**Figure 6. Turn-On Resistance vs.  $I_D$**

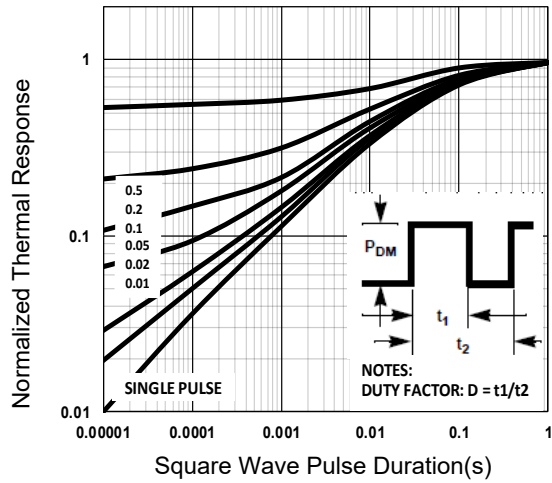
**Typical Electrical and Thermal Characteristic Curves**



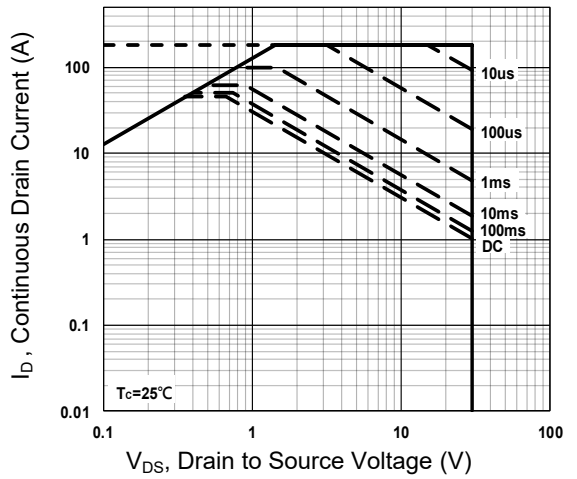
**Figure 7. Capacitance vs. V<sub>DS</sub>**



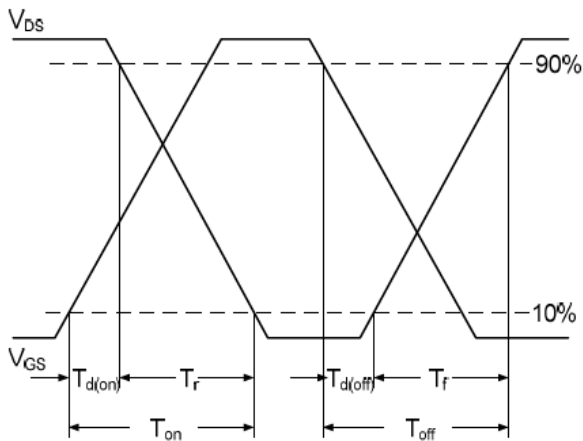
**Figure 8. Gate Charge Waveform**



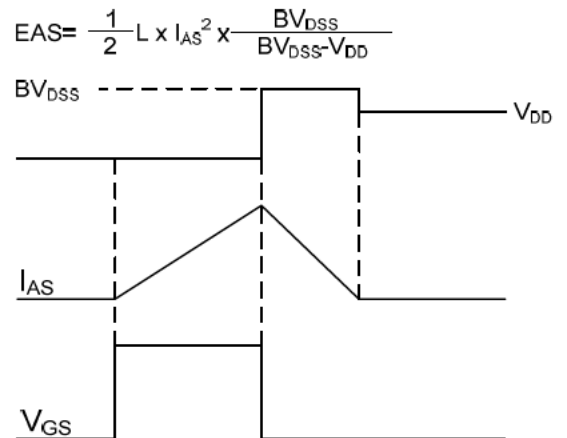
**Figure 9. Normalized Transient Impedance**



**Figure 10. Maximum Safe Operation Area**

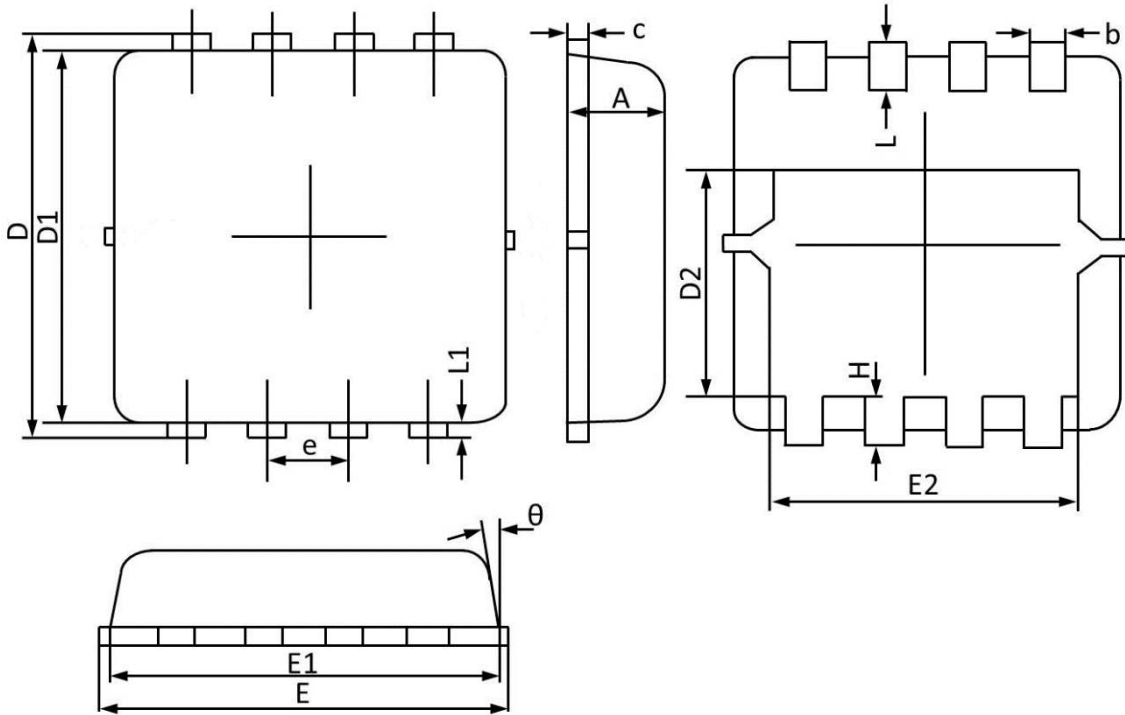


**Figure 11. Switching Time Waveform**



**Figure 12. EAS Waveform**

**Package Outline Dimensions (PPAK3x3)**



Symbol	Dimensions In Millimeters		Dimensions In Inches	
	MAX	MIN	MAX	MIN
A	0.900	0.700	0.035	0.028
b	0.350	0.250	0.014	0.010
c	0.250	0.100	0.010	0.004
D	3.500	3.050	0.138	0.120
D1	3.200	2.900	0.126	0.114
D2	1.950	1.350	0.077	0.053
E	3.400	3.000	0.134	0.118
E1	3.300	2.900	0.130	0.114
E2	2.600	2.350	0.102	0.093
e	0.65BSC		0.026BSC	
H	0.750	0.300	0.030	0.012
L	0.600	0.300	0.024	0.012
L1	0.200	0.060	0.008	0.002
θ	14°	6°	14°	6°