

Turbo 2 ultrafast high voltage rectifier

Datasheet – production data

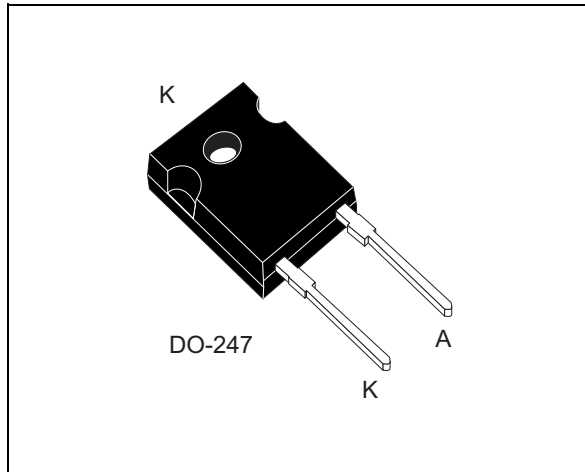

Description

The STTH75S12 is developed using ST's Turbo 2 1200 V technology. It is well-suited as a boost diode, especially for use in UPS.

Table 1. Device summary

Symbol	Value
$I_{F(AV)}$	75 A
V_{RRM}	1200 V
t_{rr} (typ)	40 ns
V_F (typ)	1.9 V
T_j (max)	175 °C

Features

- Ultrafast switching
- Low reverse current
- Low thermal resistance
- Reduces switching and conduction losses

1 Characteristics

Table 2. Absolute ratings (limiting values at $T_j = 25\text{ °C}$, unless otherwise specified)

Symbol	Parameter	Value	Unit
V_{RRM}	Repetitive peak reverse voltage	1200	V
$I_{F(RMS)}$	Forward rms current	106	A
$I_{F(AV)}$	Average forward current, $\delta = 0.5$	$T_c = 80\text{ °C}$	A
I_{FSM}	Surge non repetitive forward current	$t_p = 10\text{ ms sinusoidal}$	A
T_{stg}	Storage temperature range	-65 to +175	°C
T_j	Maximum operating junction temperature	175	°C

Table 3. Thermal parameters

Symbol	Parameter	Value	Unit
$R_{th(j-c)}$	Junction to case	0.35	°C/W

Table 4. Static electrical characteristics

Symbol	Parameter	Test conditions	Min.	Typ.	Max.	Unit
$I_R^{(1)}$	Reverse leakage current	$T_j = 25\text{ °C}$	$V_R = V_{RRM}$		50	μA
		$T_j = 150\text{ °C}$		0.2	2	mA
$V_F^{(2)}$	Forward voltage drop	$T_j = 25\text{ °C}$	$I_F = 75\text{ A}$		3.2	V
		$T_j = 150\text{ °C}$		1.9	2.7	

1. Pulse test: $t_p = 5\text{ ms}$, $\delta < 2\%$
2. Pulse test: $t_p = 380\text{ }\mu\text{s}$, $\delta < 2\%$

To evaluate the conduction losses use the following equation:

$$P = 1.8 \times I_{F(AV)} + 0.012 I_{F(RMS)}^2$$

Table 5. Dynamic characteristics

Symbol	Parameter	Test conditions	Min.	Typ.	Max.	Unit	
t_{rr}	Reverse recovery time	$T_j = 25\text{ °C}$	$I_F = 1\text{ A}$, $V_R = 30\text{ V}$, $di_F/dt = 200\text{ A}/\mu\text{s}$		40	55	ns
I_{RM}	Reverse recovery current	$T_j = 125\text{ °C}$	$I_F = 75\text{ A}$, $V_R = 600\text{ V}$, $di_F/dt = 200\text{ A}/\mu\text{s}$		26	37	A
S	Softness factor				1.2		
Q_{RR}	Reverse recovery charge				5300		nC

Figure 1. Average forward power dissipation versus average forward current

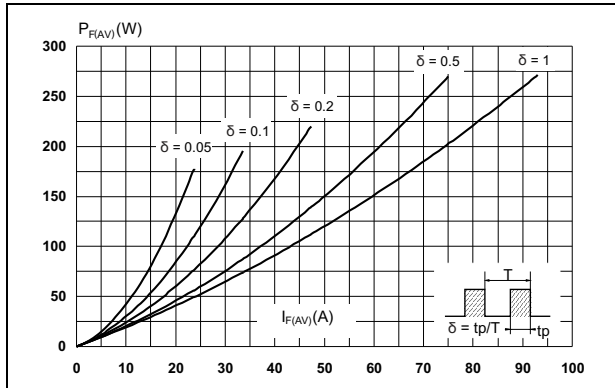

Figure 2. Forward voltage drop versus forward current (typical values)

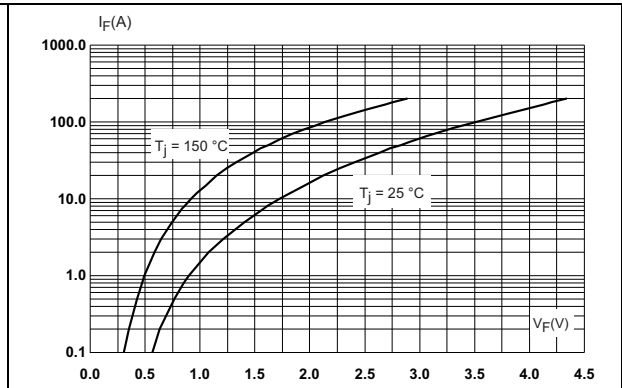

Figure 3. Forward voltage drop versus forward current (maximum values)

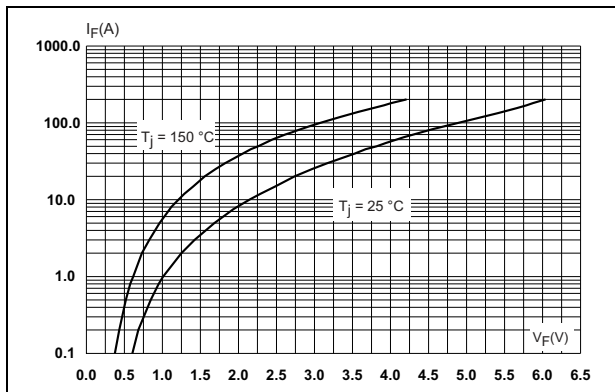

Figure 4. Relative variation of thermal impedance, junction to case, versus pulse duration

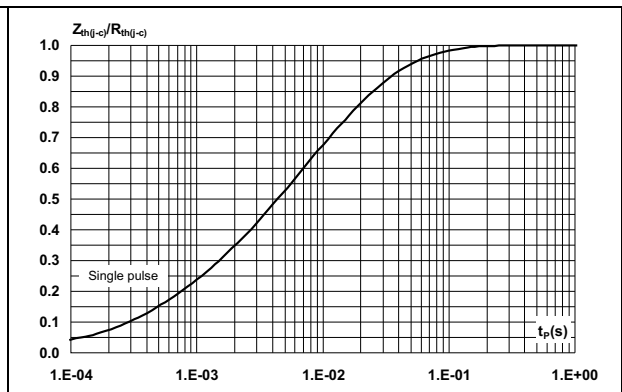

Figure 5. Peak reverse recovery current versus di_F/dt (typical values)

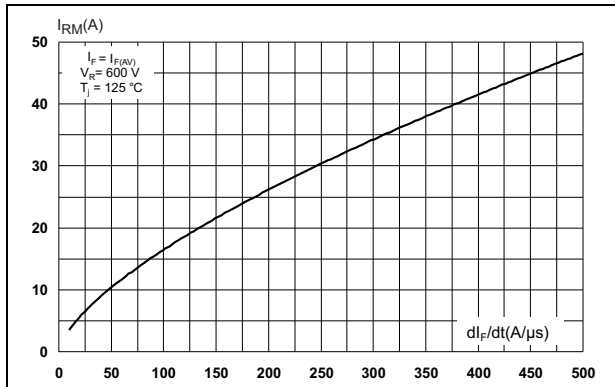

Figure 6. Reverse recovery time versus di_F/dt (typical values)

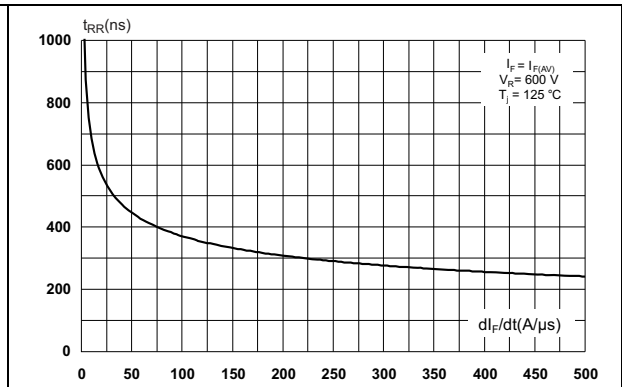

Figure 7. Reverse recovery charges versus di_F/dt (typical values)

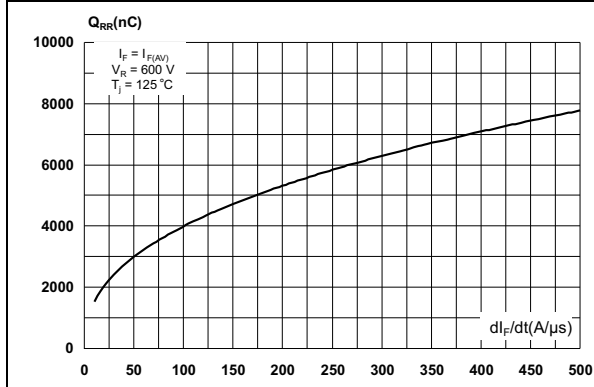

Figure 8. Reverse recovery softness factor versus di_F/dt (typical values)

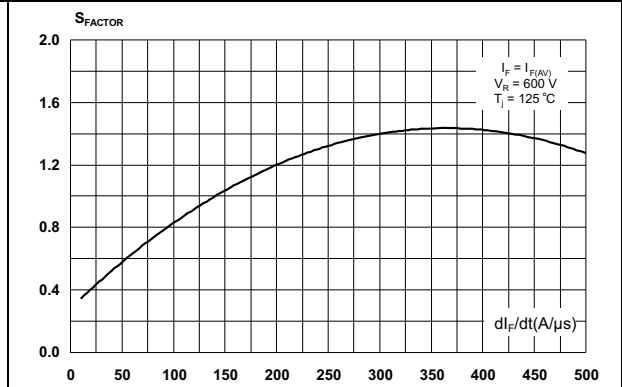

Figure 9. Relative variations of dynamic parameters versus junction temperature

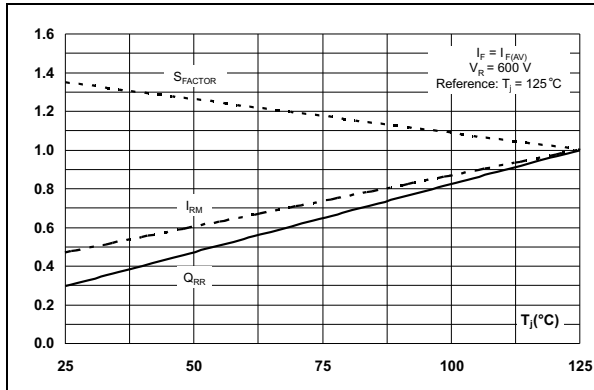
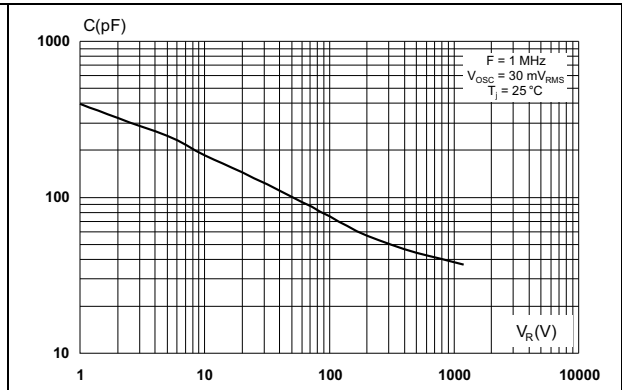

Figure 10. Junction capacitance versus reverse voltage applied (typical values)



2 Package information

- Epoxy meets UL94, V0
- Cooling method: by conduction (C)
- Recommended torque value: 0.4 N·m to 0.6 N·m

In order to meet environmental requirements, ST offers these devices in different grades of ECOPACK[®] packages, depending on their level of environmental compliance. ECOPACK[®] specifications, grade definitions and product status are available at: www.st.com. ECOPACK[®] is an ST trademark.

Figure 11. DO-247 dimension definitions

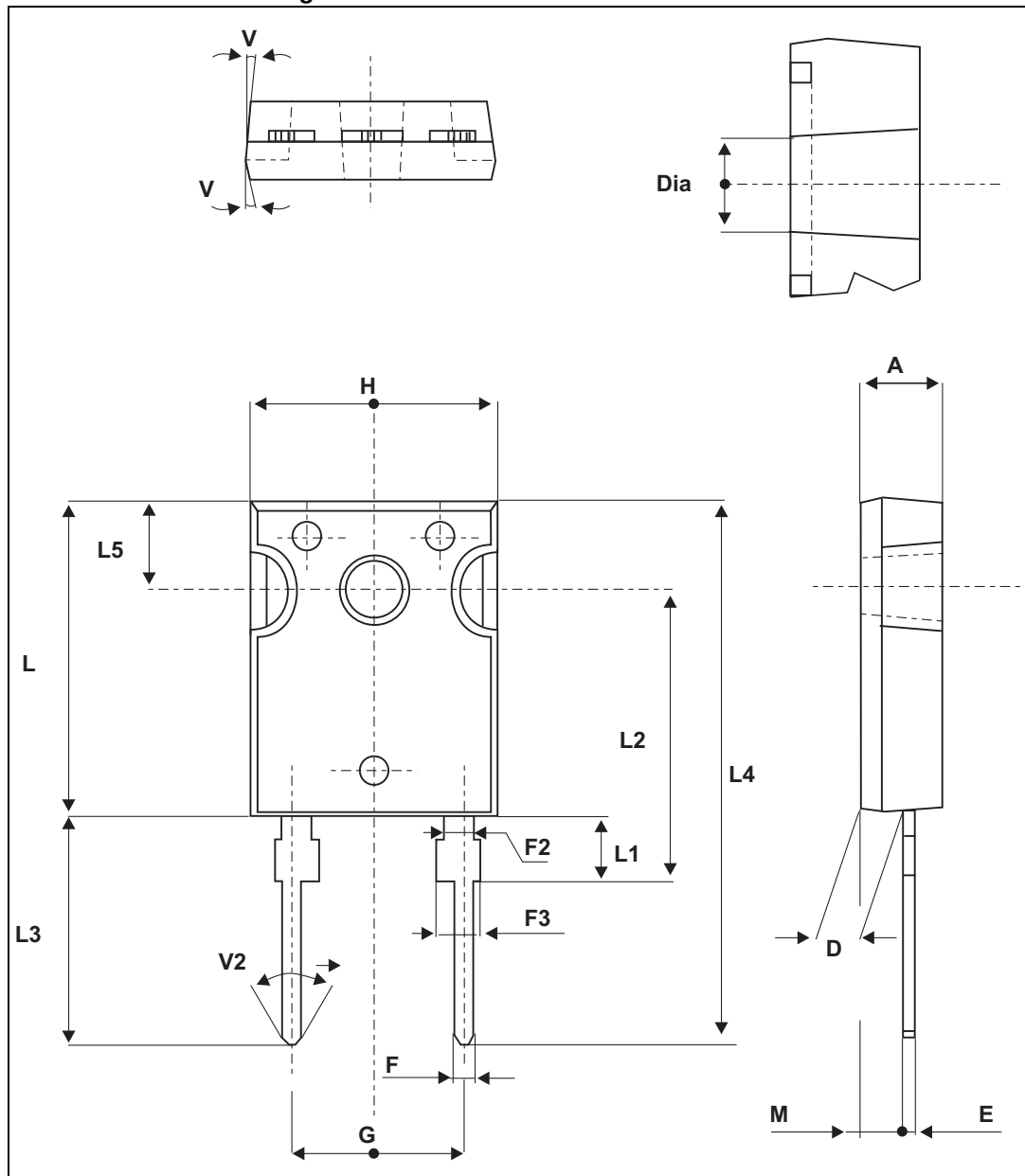

Table 6. DO-247 dimension values

Ref.	Dimensions					
	Millimeters			Inches		
	Min.	Typ.	Max.	Min.	Typ.	Max.
A	4.85		5.15	0.191		0.203
D	2.20		2.60	0.086		0.102
E	0.40		0.80	0.015		0.031
F	1.00		1.40	0.039		0.055
F2		2.00			0.078	
F3	2.00		2.40	0.078		0.094
G		10.90			0.429	
H	15.45		15.75	0.608		0.620
L	19.85		20.15	0.781		0.793
L1	3.70		4.30	0.145		0.169
L2		18.50			0.728	
L3	14.20		14.80	0.559		0.582
L4		34.60			1.362	
L5		5.50			0.216	
M	2.00		3.00	0.078		0.118
V		5°			5°	
V2		60°			60°	
Dia.	3.55		3.65	0.139		0.143

3 Ordering information

Table 7. Ordering information

Order code	Marking	Package	Weight	Base qty	Delivery mode
STTH75S12W	STTH75S12W	DO-247	4.46 g	50	Tube

4 Revision history

Table 8. Document revision history

Date	Revision	Changes
18-Sep-2014	1	Initial release

IMPORTANT NOTICE – PLEASE READ CAREFULLY

STMicroelectronics NV and its subsidiaries ("ST") reserve the right to make changes, corrections, enhancements, modifications, and improvements to ST products and/or to this document at any time without notice. Purchasers should obtain the latest relevant information on ST products before placing orders. ST products are sold pursuant to ST's terms and conditions of sale in place at the time of order acknowledgement.

Purchasers are solely responsible for the choice, selection, and use of ST products and ST assumes no liability for application assistance or the design of Purchasers' products.

No license, express or implied, to any intellectual property right is granted by ST herein.

Resale of ST products with provisions different from the information set forth herein shall void any warranty granted by ST for such product.

ST and the ST logo are trademarks of ST. All other product or service names are the property of their respective owners.

Information in this document supersedes and replaces information previously supplied in any prior versions of this document.

© 2014 STMicroelectronics – All rights reserved