

アルカリマンガン電池
Alkaline manganese batteries

LR44

■外形寸法 Dimensions(mm)

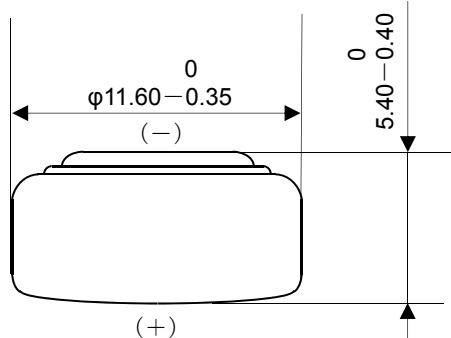

■刻印 Monogram



■定格 Specifications

公称電圧 Nominal Voltage	1.50 V
公称容量 (終止電圧 0.9V) Nominal Capacity (0.9V cutoff)	120 mAh
標準放電負荷 Standard Discharge Load ※公称電圧/抵抗 Nominal Voltage/Standard Load	4.7 k Ω (≈ 0.3 mA)
標準質量 Weight	2.0 g
使用温度範囲 Operating Temperature	-10 ~ +60°C
水銀使用率 0% No mercury added	

■放電特性 Discharge Characteristics

load : 4.7k Ω temperature: 23°C

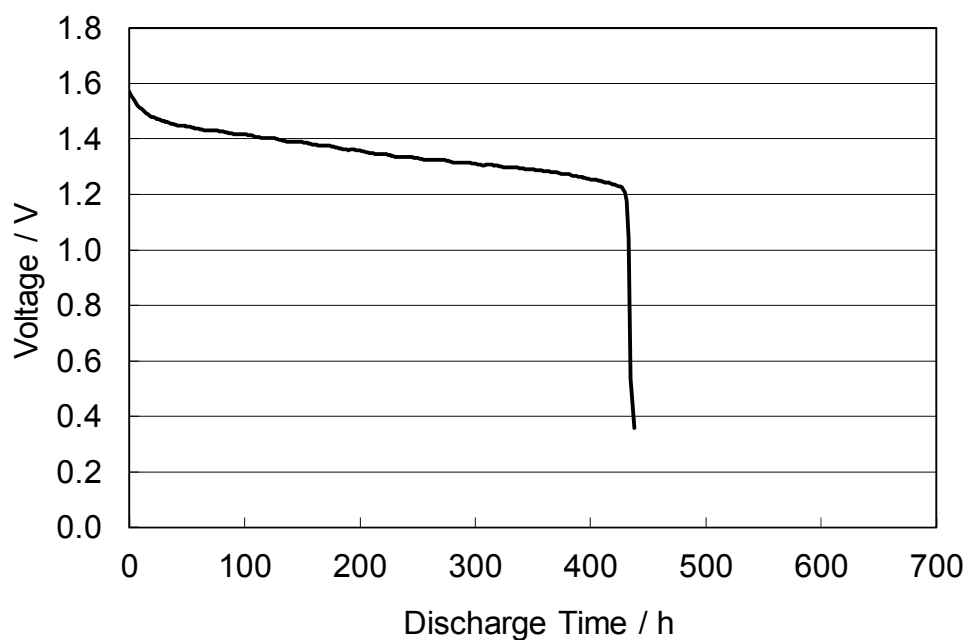

■ 放電負荷特性

Discharge Characteristics on Load

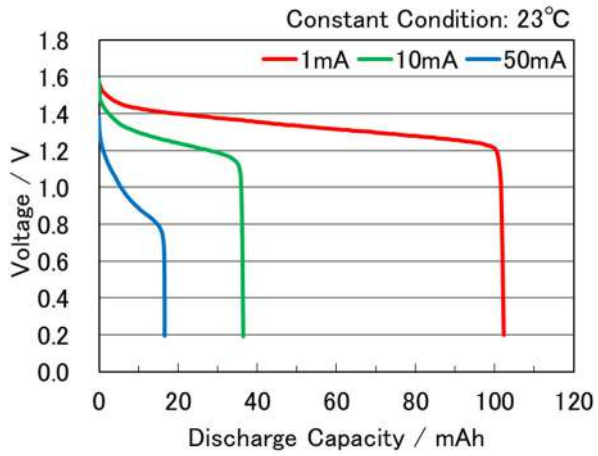

■ 放電温度特性

Discharge Characteristics by Temperature

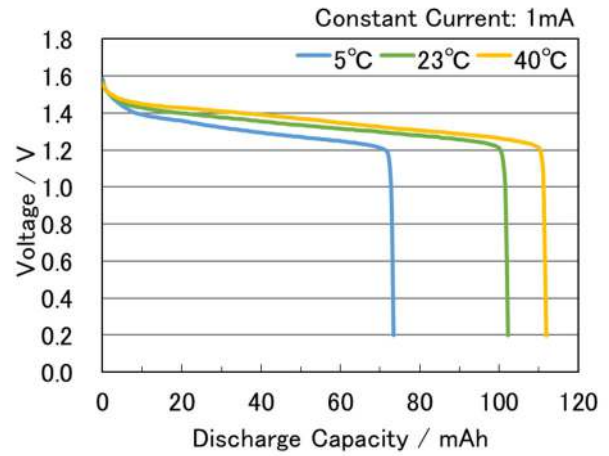

■ 放電負荷と放電容量

Discharge Load vs. Discharge Capacity

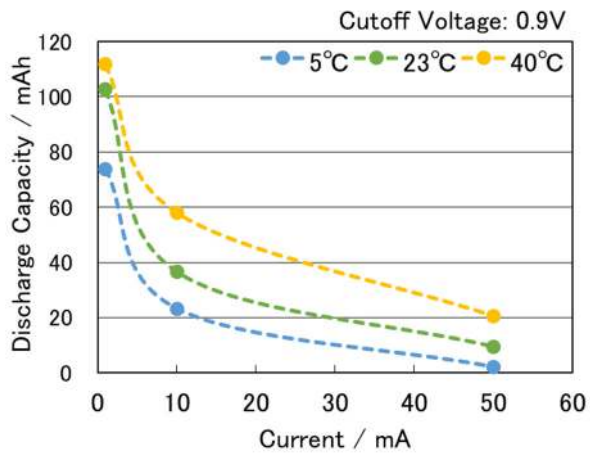

*記載のデータ及び数値は、参考値であり保証値ではありません。

*Data is not guaranteed, and is provided for reference purposes only.