

SPECIFICATION FOR APPROVAL

1/8W, 0402 Low Resistance Chip Resistor (Lead / Halogen free)

1. Scope

This specification applies to 0.5mm x 1.0mm size 1/8W, fixed metal film chip resistors rectangular type for use in electronic equipment.

2. Type Designation

RL 1005 — 2 — □□□□ □

(1) (2) (3) (4)

Where

- (1) Series No.
- (2) Power rating
2 = 1/8W
- (3) Resistance value:
For example—
R075 = 0.075 Ω
R100 = 0.1 Ω
- (4) Resistance tolerance:
F= ± 1%
G= ± 2%
J= ± 5%

3. Construction and Physical Dimensions

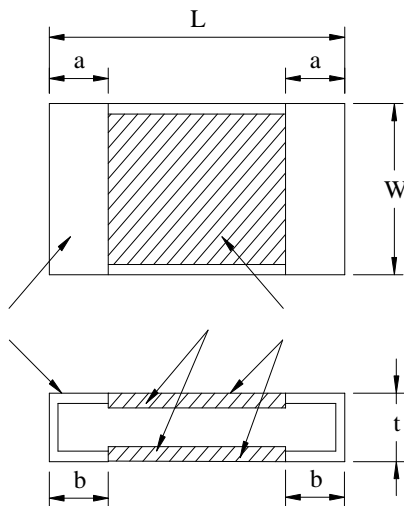

Code Letter	Dimensions (mm)
L	1.00 ± 0.1
W	0.50 ± 0.1
t	0.35 ^{+0.15} _{-0.10}
a	0.25 ± 0.1
b	0.25 ± 0.1

NOTE:

- ① Resistive element
(under protection film)
- ② Electrode
- ③ Protection film
- ④ Substrate

Figure 1. Structure (No mark)



SPECIFICATION FOR APPROVAL

4. Ratings

4-1 Specification

Power Rating*	1/8 W	
Resistance Range	0.020Ω ~ <0.070Ω	0.070Ω ~ 1Ω
Resistance Tolerance	±1% , ±2% , ±5%	±1% , ±2% , ±5%
Temperature Coefficient of Resistance	0~500ppm/°C	±100ppm/°C

Note*:

Power Rating is based on continuous full load operation at rated ambient temperature of 70°C. For resistors operated at ambient temperature in excess of 70°C, the maximum load shall be derated in accordance with the following curve.

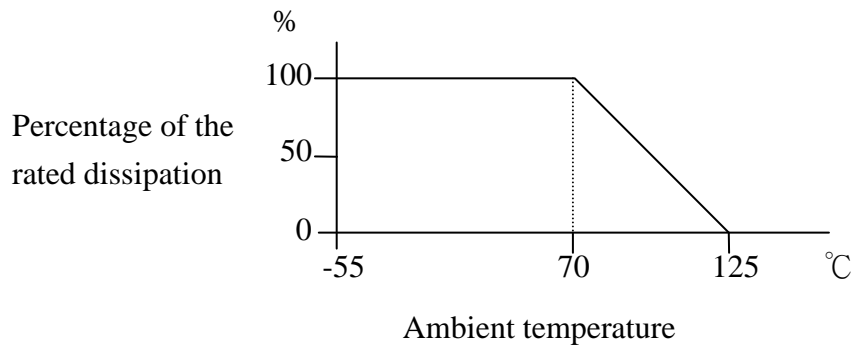

Figure 2 Derating Curve

4-2 Rated Voltage

The rated voltage shall be determined by the following expression.

$$V = \sqrt{P \times R}$$

Where V : Rated voltage (V)

R : Nominal resistance value (Ω)

P : Rated dissipation (W)

4-3 Operating and Storage Temperature Range

-55 to +125°C



SPECIFICATION FOR APPROVAL

5. Characteristics

Test Item	Condition of Test	Requirements
Short Time Overload	2.5 * Rated power for 5 seconds Refer to JIS C 5201-1 4.13	$\Delta R : \pm (0.5\% + 0.0005\Omega)$ Without significant damage by flashover (spark, arching), burning or breakdown etc.
Insulation Resistance	The resistor shall be cramped in the metal block and tested , as shown below. Test voltage : $100 \pm 15V_{DC}$ for 1 minute Refer to JIS C 5201-1 4.6 Mounting condition G.	Between Electrode and Protection Film $100M\Omega$ or over Between Electrode and Substrate $1,000M\Omega$ or over
Voltage Proof	The voltage : $100V_{AC}$ (rms.) for 1 minute Refer to JIS C 5201-1 4.7	$\Delta R : \pm (0.5\% + 0.0005\Omega)$ Without damage by flashover, fire or breakdown, as shown below.
Thermal Shock	$-55 \sim 125^{\circ}C$ 5 cycles, 15 min at each extreme condition Refer to JIS C 5201-1 4.19	$\Delta R : \pm (1.0\% + 0.0005\Omega)$ Without distinct damage in appearance
Low Temperature Storage	Kept at $-55^{\circ}C$, 1,000 hours Refer to JIS C 5201-1 4.23.4	$\Delta R : \pm (1.0\% + 0.0005\Omega)$ Without distinct damage in appearance
High Temperature Exposure	Kept at $125^{\circ}C$ for 1,000 hours Refer to JIS C 5201-1 4.23.2	$\Delta R : \pm (1.0\% + 0.0005\Omega)$ Without distinct damage in appearance
Solderability	Temperature of Solder : $245 \pm 5^{\circ}C$ Immersion Duration : 2 ± 0.5 second Refer to JIS C 5201-1 4.17	Uniform coating of solder cover minimum of 95% surface being immersed
Resistance to Soldering Heat	Dipped into solder at $270 \pm 5^{\circ}C$ for 10 ± 1 seconds Refer to JIS C 5201-1 4.18	$\Delta R : \pm (0.5\% + 0.0005\Omega)$ Without distinct deformation in appearance

**SPECIFICATION FOR APPROVAL**

Test Item	Condition of Test	Requirements
Load Life	Rated voltage for 1.5 hours followed by a pause 0.5 hour at $70 \pm 2^{\circ}\text{C}$. Cycle repeated 1000 hours Refer to JIS C 5201-1 4.25	$\Delta R : \pm (1.0\% + 0.0005\Omega)$ Without distinct damage in appearance
Damp Heat with Load	$60 \pm 2^{\circ}\text{C}$ with relative humidity 90% to 95%. D.C. rated voltage for 1.5 hours ON and 30 minutes OFF. Cycle repeated 1,000 hours Refer to JIS C 5201-1 4.24	$\Delta R : \pm (1.0\% + 0.0005\Omega)$ Without distinct damage in appearance
Mechanical Shock	100 G's for 6 milliseconds. 5 pulses Refer to JIS C 5201-1 4.21	$\Delta R : \pm (0.5\% + 0.0005\Omega)$ Without mechanical damage such as break
Bending Test	Glass-Epoxy board thickness : 1.6mm Bending width : 2mm Between the fulcrums : 90mm Refer to JIS C 5201-1 4.33	$\Delta R : \pm (0.5\% + 0.0005\Omega)$ Without mechanical damage such as break

SPECIFICATION FOR APPROVAL

Mounting of the test sample onto the test board shall be either of following methods.

(1) Mounting by solder dipping

Epoxy based glue shall be applied in the middle of two lands of the test board. The resistor shall be mounted in such a way that the electrodes of resistors will be evenly placed in the land area and then adhesive resin shall be cured. After applying the Resin Flux with 25 weight % Methyl Alcohol, the board shall be soldered by dipping into a molten solder bath with $260 \pm 5^{\circ}\text{C}$ for 3 to 5 seconds

(2) Mounting by Reflow soldering

Solder paste with approximate $200 \mu\text{m}$ thickness shall be applied to the land of test board. The resistor shall be mounted in such way that the electrodes of resistors will be evenly placed in the land area and then shall be soldered under the circumstance that the surface temperature of the board shall be raised $245 \pm 5^{\circ}\text{C}$ (peak) for 5 to 10 seconds in an upper-heater oven.

Material : Glass Fabric Epoxy Resin (Refer to JIS C 6484)

Board thickness : 1.6mm

Copper foil thickness : 0.035mm

Solder Resist Coating

Test board A (for substrate bending test)

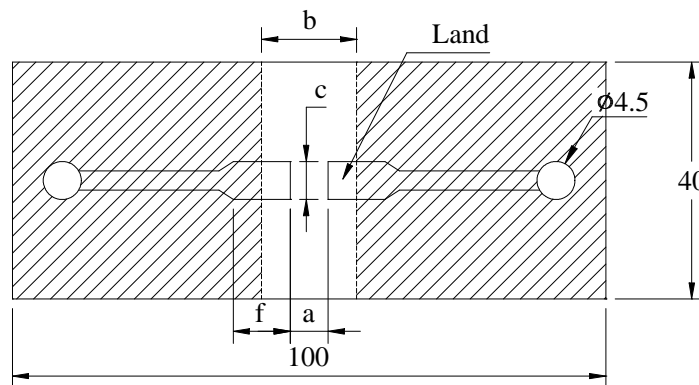

a	b	c	f
0.6	2.0	0.7	(2.0)

Unit : mm



SPECIFICATION FOR APPROVAL

Test board B (for another test)

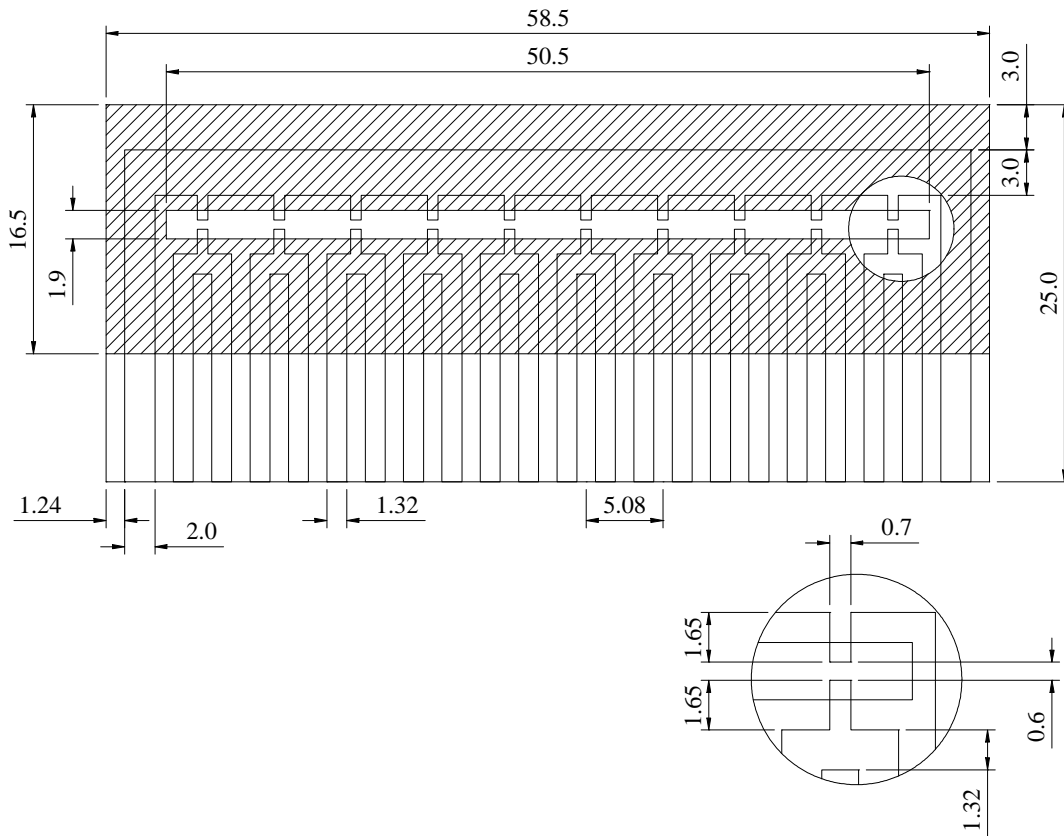

Unit : mm

SPECIFICATION FOR APPROVAL

6. Packaging

6-1 Dimensions

6-1-1 Tape packaging dimensions

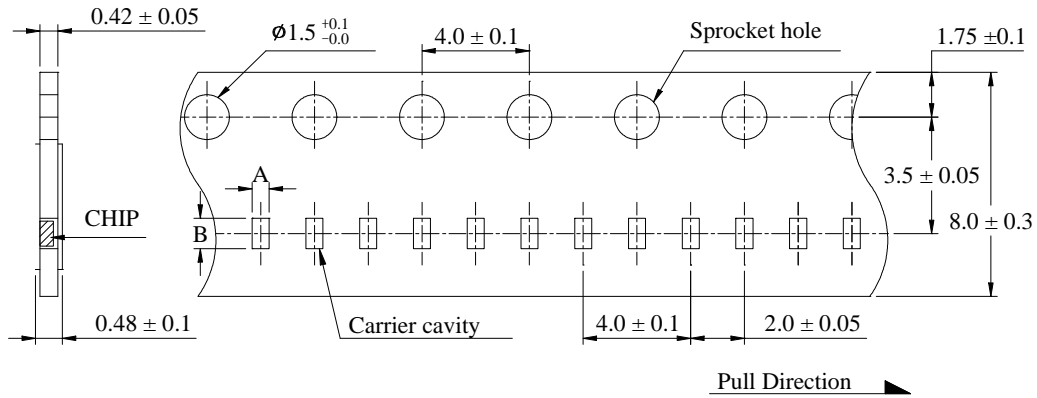

※ Pre-empted holes : 150 holes (or 30cm) or more.

Code letter	a	b
Dimension	0.68 ± 0.05	1.18 ± 0.05

Unit : mm

6-1-2 Reel Dimensions (Plastic reel : Correspond with EIAJ RRV08B)

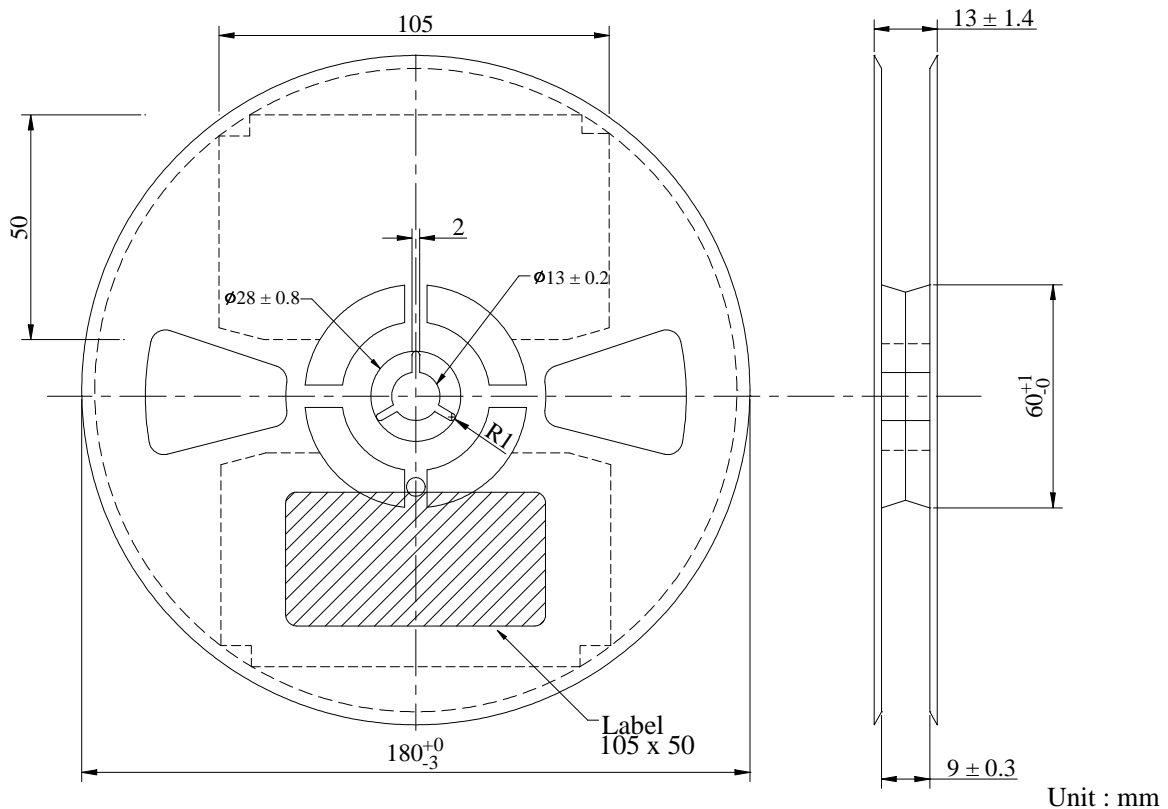

SPECIFICATION FOR APPROVAL

6-2 Peel force of top cover tape

The peel speed shall be about 300 mm / min.

The peel force of top cover tape shall be between 0.1 to 0.7 N.

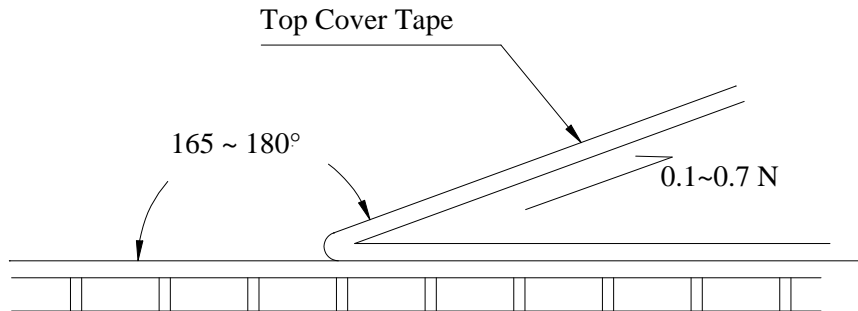

6-3 Numbers of taping

10,000 pieces / reel

6-4 Making

The following items shall be marked on the reel.

- (1) Type designation
- (2) Quantity
- (3) Manufacturing date code
- (4) Manufacturer's name
- (5) The country of origin