



Through Hole Lamp Product Data Sheet LTLMR4YVX3DA

Spec No. :DS20-2020-0002
Effective Date: 01/24/2020
Revision: -

LITE-ON DCC

RELEASE

BNS-OD-FC001/A4

Surface Mount Lamp
LTLMR4YVX3DA

Surface Mount Lamp

LTLMR4YVX3DA

<u>Rev</u>	<u>Description</u>	<u>By</u>	<u>Date</u>
P001	Preliminary DS (RDR-20190542-01)	Perry	05/28/2019
Above data for PD and Customer tracking only			
-	Upload DS to system	Perry	12/26/2019

Surface Mount Lamp LTLMR4YVX3DA

1. Description

LiteON surface mount lamp is a high brightness LED in the form of surface mount device. It can be using common SMT assembly processes and compatible with industrial reflow soldering processes. Surface mount lamp LEDs are offered in round and oval lens packages which are suitable for sign board applications with smooth radiation pattern, especially narrow viewing angle control without adding optical lens which compare with standard SMD or PLCC. Advanced epoxy technology has a good moisture resistance and UV protection to be used in package.

1.1. Features

- High Luminous intensity output.
- Low power consumption & High efficiency.
- Superior resistance to moisture
- Lead free & Halogen free & RoHS Compliant
- Yellow AlInGaP 590nm Lamp, Yellow Diffused package.
- Typical viewing angle 35°
- MSL3

1.2. Applications

- Video message sign
- Traffic sign
- Message sign

2. Outline Dimensions

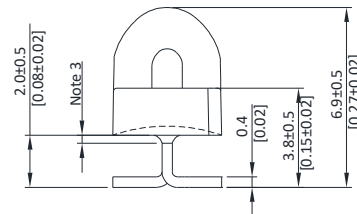
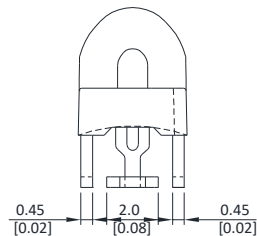
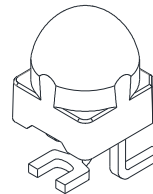
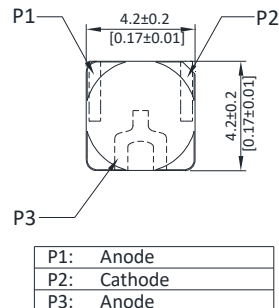

Notes :

1. All dimensions are in millimeters (inches).
2. Tolerance is ±0.25mm (.010") unless otherwise noted.
3. Protruded resin under flange is 1.0mm (.04") max.
4. Lead spacing is measured where the leads emerge from the package.
5. Specifications are subject to change without notice.

Surface Mount Lamp LTLMR4YVX3DA

3. Absolute Maximum Ratings at TA=25°C

Parameter	Maximum Rating	Unit
Power Dissipation	120	mW
Peak Forward Current (Duty Cycle \leq 1/10, Pulse Width \leq 10ms)	120	mA
DC Forward Current	50	mA
Derating Linear From 45°C	0.75	mA/°C
Operating Temperature Range	-40°C to + 85°C	
Storage Temperature Range	-40°C to + 100°C	
Reflow Soldering Condition	260°C for 10 Seconds Max.	

4. Electrical / Optical Characteristics at TA=25°C

Parameter	Symbol	Min.	Typ.	Max.	Unit	Test Condition
Luminous Intensity	Iv	4200		9300	mcd	IF = 20mA Note 1,5
Viewing Angle	$\theta_{1/2}$	30	35		deg	Note 2,7 (Fig.6)
Peak Emission Wavelength	λ_P		594		nm	Measurement @Peak (Fig.1)
Dominant Wavelength	λ_d	584.5		594.5	nm	Note 4
Spectral Line Half-Width	$\Delta\lambda$		15		nm	
Forward Voltage	VF	1.8		2.4	V	IF = 20mA
Reverse Current	IR			10	μ A	VR = 5V

NOTE:

- Luminous intensity is measured with a light sensor and filter combination that approximates the CIE eye-response curve.
- $\theta_{1/2}$ is the off-axis angle at which the luminous intensity is half the axial luminous intensity.
- Iv classification code is marked on each packing bag.
- The dominant wavelength, λ_d is derived from the CIE chromaticity diagram and represents the single wavelength which defines the color of the device.
- Iv guarantee must be included with $\pm 15\%$ testing tolerance.
- Reverse voltage (VR) condition is applied for IR test only. The device is not designed for reverse operation.
- View angle measurement is ± 2 degree tolerance.

Surface Mount Lamp LTLMR4YVX3DA

5. Typical Electrical / Optical Characteristics Curves

(25°C Ambient Temperature Unless Otherwise Noted)

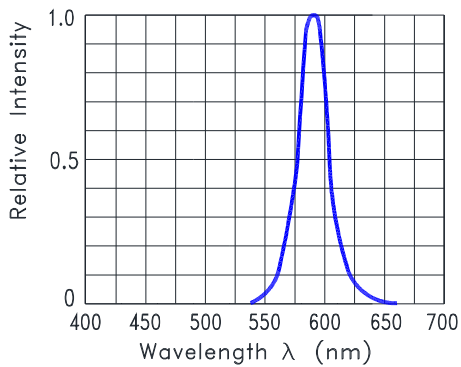

Fig.1 Relative Intensity VS. Wavelength

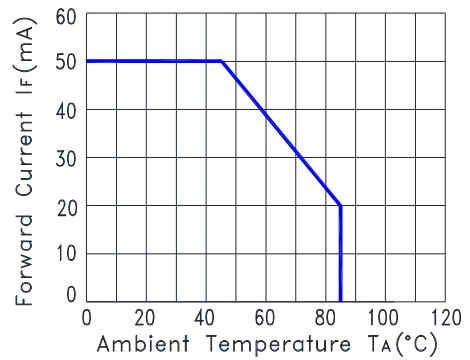

Fig.2 Forward Current Derating Curve

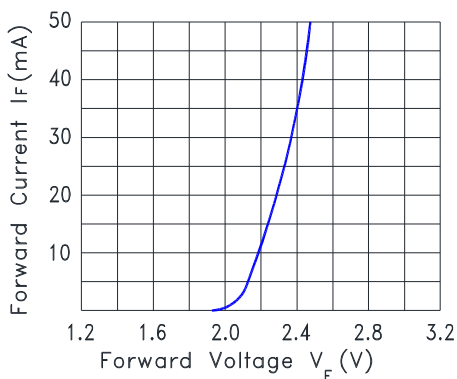

Fig.3 Forward Current vs. Forward Voltage

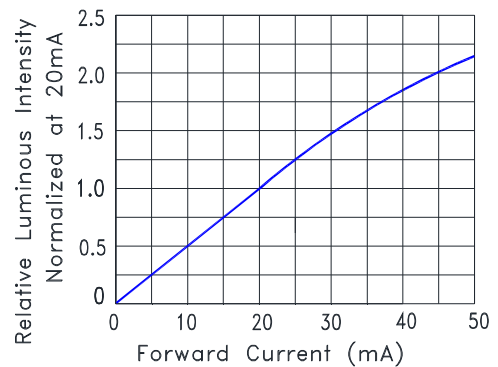

Fig.4 Relative Luminous Intensity vs. Forward Current

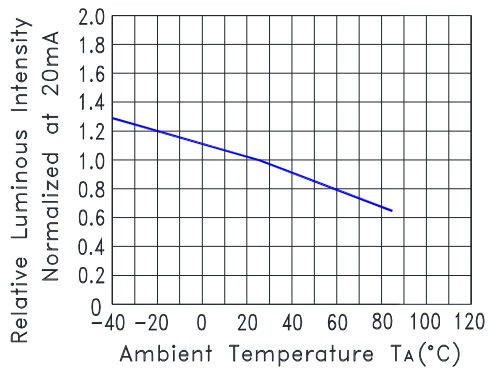

Fig.5 Relative Luminous Intensity VS. Ambient Temperature

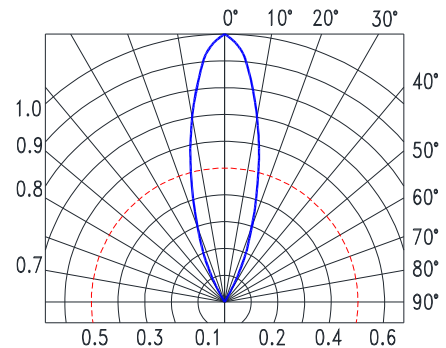
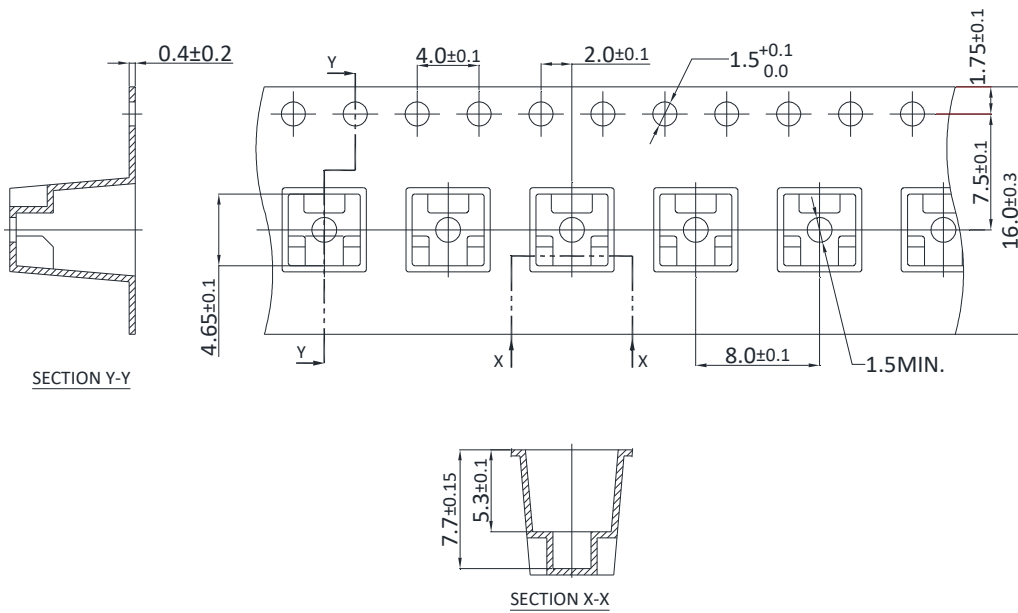

Fig.6 Spatial Distribution

Surface Mount Lamp LTLMR4YVX3DA

6. Packing Spec.

Packing Carrier Tape Dimensions



Total 1,000pcs per packing reel

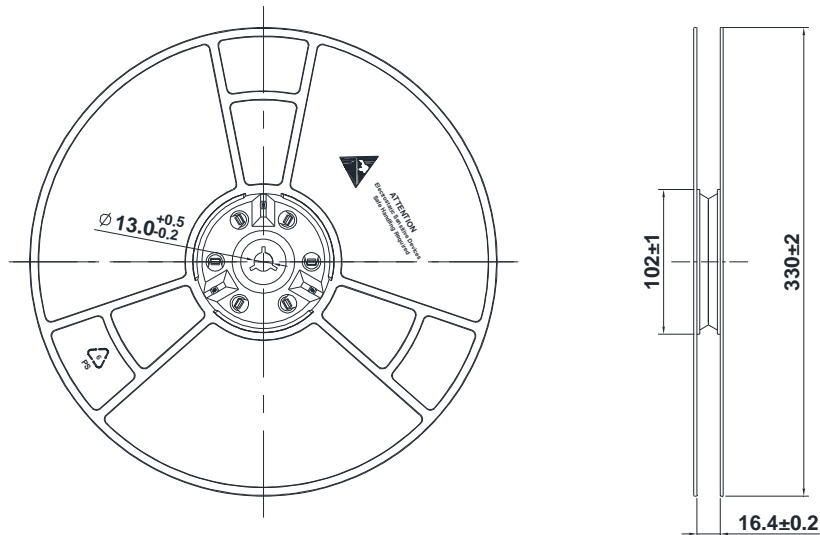

Notes :

1. All dimensions are in millimeters.

**Surface Mount Lamp
LTLMR4YVX3DA**

7. Bin Table Specification

Luminous Intensity Iv (mcd) IF@20mA		
Bin Code	Min.	Max.
V	4200	5500
W	5500	7200
X	7200	9300

Note: Tolerance of each bin limit is $\pm 15\%$

Dominant Wavelength Wd (nm) IF@20mA		
Bin Code	Min	Max
Y1	584.5	587.0
Y2	587.0	589.5
Y3	589.5	592.0
Y4	592.0	594.5

Note: Tolerance of each bin limit is $\pm 1\text{nm}$

Forward Voltage Vf (V) IF@20mA		
Bin Code	Min	Max
1A	1.8	2.0
2A	2.0	2.2
3A	2.2	2.4

Note: Tolerance of each bin limit is $\pm 0.1\text{V}$

Surface Mount Lamp LTLMR4YVX3DA

8. CAUTIONS

8.1. Application

This LED lamp is good for application of indoor and outdoor sign, also ordinary electronic equipment.

8.2. Storage

The product is Moisture Sensitive Level 3, refer to JEDEC J-STD-020. The LEDs in a sealed moisture barrier bag can be stored at < 30°C and 90% RH (relative humidity) for 12 months. If the actual shelf life has exceeded 12 months and the humidity indicator card indicates that baking is not required, it is safe to reflow the LEDs per the original MSL rating. After opening the moisture barrier bag, keep the LEDs under < 30°C and 60% RH at all time and complete solde ring or other high temperature process within 168 hours.

Baking is required, once LEDs are stored out of original packaging with

- The humidity indicator card indicates >10% RH.
- Floor life over 168hrs.
- Exposed to > 30°C and 60% RH.

The recommended baking condition is 60°C±5°C for 20 hours and baking should only be done once.

If LEDs are exposed in ambient environments for too long, the silver plating on lead might be oxidized and affecting its solderability. Unused remaining LEDs should be stored with silica gel desiccants in a sealed moisture barrier bag.

8.3. Cleaning

Use alcohol-based cleaning solvents such as isopropyl alcohol to clean the LEDs if necessary.

8.4. Soldering

Recommended soldering conditions:

Reflow soldering		Soldering iron	
Pre-heat	150~200°C	Temperature	315°C Max.
Pre-heat time	120 sec. Max.	Soldering time	3 sec. Max. (one time only)
Peak temperature	260°C Max.		
Soldering time	10 sec. Max. (Max. two times)		

Recommended lead free reflow soldering profile:

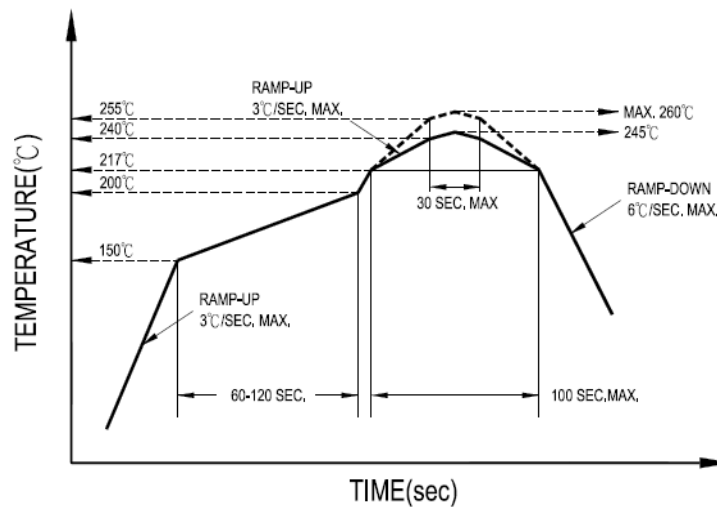

Surface Mount Lamp LTLMR4YVX3DA

Recommended soldering pad pattern:

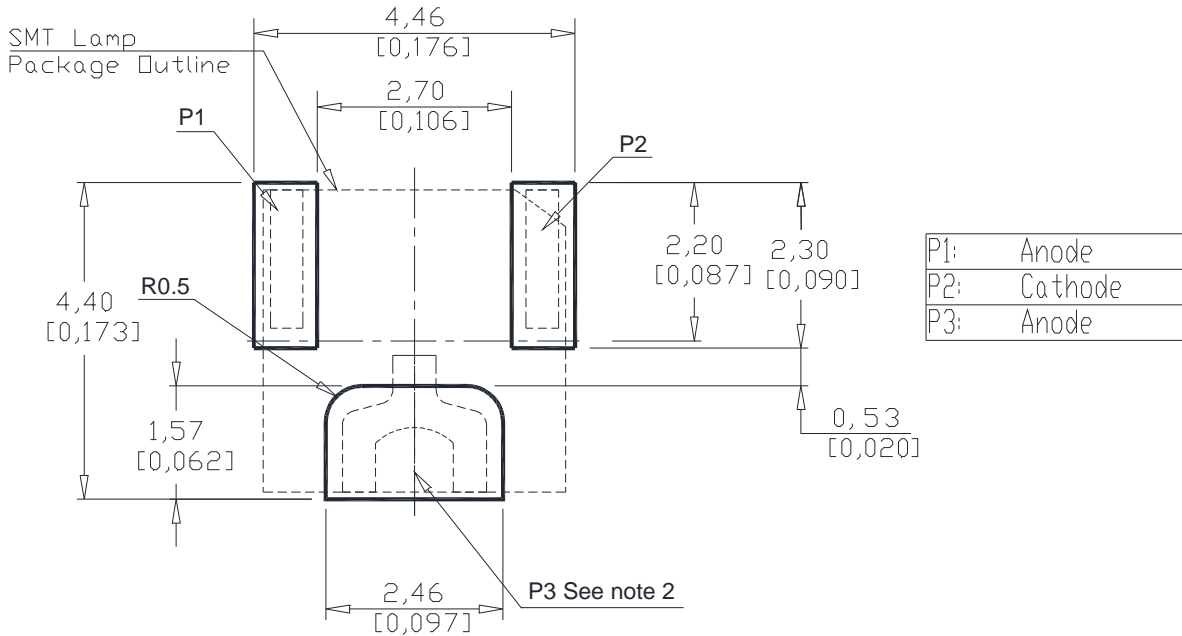

Notes:

1. This LED is designed to be reflow soldered on PCB and not suitable for dip soldered.
2. This Pad is recommend to connect to heat sink or any cooling mechanisms as its design to distribute heat while operating.
3. Reflow soldering must not be done more than two times and hand soldering must not be done more than one time.
4. Do not apply any external stress to the LED during soldering while the LED is at high temperature.
5. Avoid rapid cooling LED from the peak temperature.

8.6. Drive Method

An LED is a current-operated device. In order to ensure intensity uniformity on multiple LEDs connected in parallel in an application, it is recommended that a current limiting resistor be incorporated in the drive circuit, in series with each LED as shown in Circuit A below.

Circuit model (A)

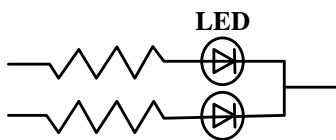

(A) Recommended circuit

Circuit model (B)

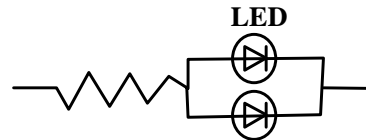

(B) The brightness of each LED might appear different due to the differences in the I-V characteristics of those LEDs.

8.7. ESD (Electrostatic Discharge)

Static Electricity or power surge will damage the LED.

Suggestions to prevent ESD damage:

- Use a conductive wrist band or anti- electrostatic glove when handling these LEDs

Surface Mount Lamp LTLMR4YVX3DA

- All devices, equipment, and machinery must be properly grounded
- Work tables, storage racks, etc. should be properly grounded
- Use ion blower to neutralize the static charge which might have built up on surface of the LEDs plastic lens as a result of friction between LEDs during storage and handling

Suggested checking list:

Training and Certification

- 8.7.1.1. Everyone working in a static-safe area is ESD-certified?
- 8.7.1.2. Training records kept and re-certification dates monitored?

Static-Safe Workstation & Work Areas

- 8.7.2.1. Static-safe workstation or work-areas have ESD signs?
- 8.7.2.2. All surfaces and objects at all static-safe workstation and within 1 ft measure less than 100V?
- 8.7.2.3. All ionizer activated, positioned towards the units?
- 8.7.2.4. Each work surface mats grounding is good?

Personnel Grounding

- 8.7.3.1. Every person (including visitors) handling ESD sensitive (ESDS) items wear wrist strap, heel strap or conductive shoes with conductive flooring?
- 8.7.3.1. If conductive footwear used, conductive flooring also present where operator stand or walk?
- 8.7.3.2. Garments, hairs or anything closer than 1 ft to ESD items measure less than 100V*?
- 8.7.3.3. Every wrist strap or heel strap/conductive shoes checked daily and result recorded for all DLs?
- 8.7.3.4. All wrist strap or heel strap checkers calibration up to date?

Note: *50V for Blue LED.

Device Handling

- 8.7.4.1. Every ESDS items identified by EIA-471 labels on item or packaging?
- 8.7.4.2. All ESDS items completely inside properly closed static-shielding containers when not at static-safe workstation?
- 8.7.4.3. No static charge generators (e.g. plastics) inside shielding containers with ESDS items?
- 8.7.4.4. All flexible conductive and dissipative package materials inspected before reuse or recycle?

Others

- 8.7.5.1. Audit result reported to entity ESD control coordinator?
- 8.7.5.2. Corrective action from previous audits completed?
- 8.7.5.3. Are audit records complete and on file?

9. Others

The appearance and specifications of the product may be modified for improvement, without prior notice.